

THE  
BUYERS AND SELLERS GUIDE  
OF CANADA 1895-6-7.

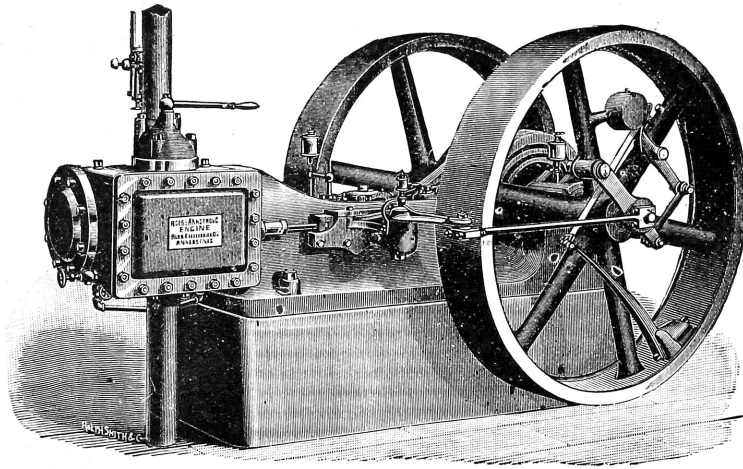



# ROBB-ARMSTRONG AUTOMATIC ENGINES

Simple, Tandem and Cross Compound

CORRECT DESIGN, BEST MATERIALS, HIGH GRADE WORK.

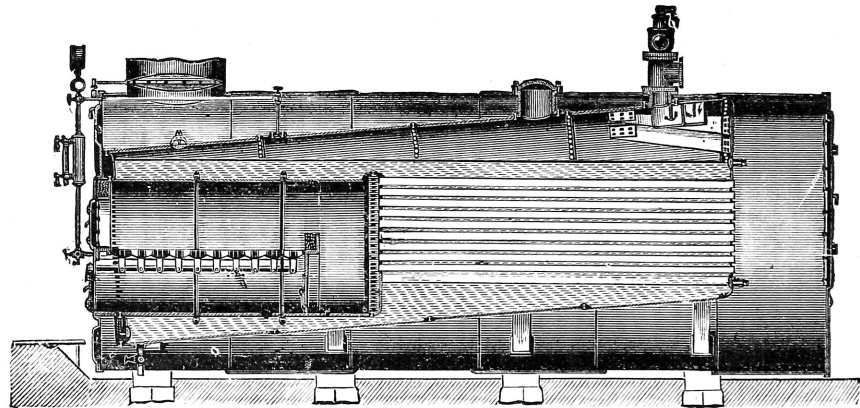

## THE MONARCH ECONOMIC BOILER

Requires No Brickwork.

And is guaranteed to save at least ten per cent. in fuel over any brickset boiler. In some cases the saving has been as high as thirty per cent.

Robb Engineering Co., Ltd.,

Amherst, N.S.



# Eastlake Steel Shingles

*Fire and Lightning Proof.*

*Durable, Ornamental and Cheap.*

**CAN BE APPLIED BY ANY ONE.**

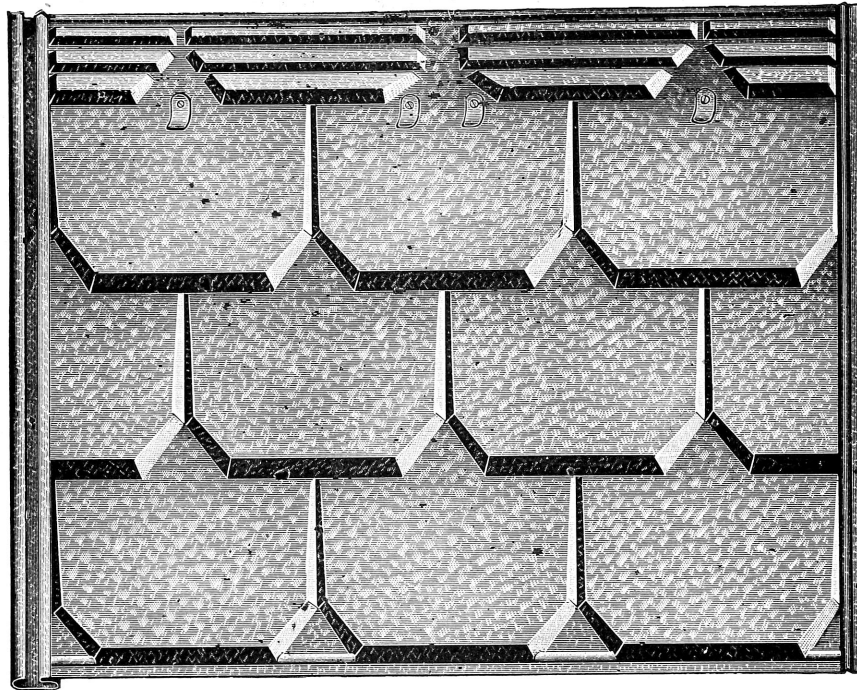

**WE ALSO MANUFACTURE:**

- |  |   |
|--|---|
| <b>Corrugated Iron, V Crimped Roofing,</b>   | <b>Ornamental Roof Cresting,</b>                        |
| <b>Standing Seam Roofing,</b>                | <b>Octagon Conductor Pipe,</b>                          |
| <b>Empire Steel Shingles,</b>                | <b>Corrugated Expans'n Conductor Pipes</b>              |
| <b>Eureka Diamond Tiles,</b>                 | . . . 10 Feet Long without a Cross Joint.               |
| <b>Spanish Tiles, Copper Tiles,</b>          | <b>Hayes' Patent Steel Lathing,</b>                     |
| <b>Sheet Steel Pressed Brick,</b>            | . The finest article for plastering on ever invented.   |
| <b>Rock Faced Steel and Elevator Sidings</b> | <b>Ornamental Embossed Steel Ceiling,</b>               |
| <b>Fire Proof Shutters and Doors,</b>        | And other Fireproof Building Material in great variety. |

**PRICES AND CATALOGUES ON APPLICATION.**

**The Metallic Roofing Co. of Canada, Ltd.**

**MANUFACTURERS,**

**TORONTO, Canada.**



DICK'S PATENT  
**BALATA BELTING.**

**CHEAPER THAN  
LEATHER.  
NEVER STRETCHES  
NEVER SLIPS.**



**STRONGER THAN  
LEATHER.  
THOROUGHLY  
WATERPROOF.**

THE MOST POWERFUL DRIVING BELT  
*SEND FOR PRICE LIST.* *IN THE WORLD.*

**THOS. FORRESTER,**

208  
St. James Street,

**MONTREAL,**

*SOLE AGENT FOR CANADA.*

**ASBESTOS, FIRE HOSE.**

**LACE LEATHER.**

All kinds of Mill, Engineers' and Factory Supplies.



THE SHIPPING  
MANUFACTURERS' LIST  
A  
BUYERS' AND SELLERS' GUIDE  
TO THE  
Manufacturers and Products of Canada.



THE MANUFACTURERS' LIST CO.  
PUBLISHERS  
MONTREAL.



Entered, according to Act of Parliament of Canada, in the year eighteen hundred and ninety-five, by the  
MANUFACTURERS' LIST CO., Montreal,  
in the Office of the Minister of Agriculture.

# Clippings from "Mail"

Monday April 12th PREFACE.

Your correspondent wired The Mail and Empire some time ago, advising holders of Elise stock not to dispose of their holdings in this company for less than ten cents per share, on account of a reorganization of this company being in progress, and I had inside information that the new company's treasury stock was to be put on the market at about that price. I am pleased to report that the Board of Directors held a meeting on April 1st, when five members of the committee resigned. The resignations being accepted, the board proceeded to fill the vacancies thus occasioned by electing in the place of those who resigned Messrs. E. L. Clarke, J. L. Whitney, E. W. Bouche, and Dr. D. Campbell. Mr. E. L. Clarke was elected president in place of Mr. Geo. Fraser, and Mr. E. W. Bouche as manager, but without salary. The new management, which has now taken formal control, closed the deal they made one month ago. Work has been resumed, and a shift of men kept going night and day. The shaft has been sunk to a depth of fifty feet, from which a drift of about thirty feet has been driven along the vein, and from this vein fifty to seventy-five tons of ore has already been taken; this is a showing that has never yet been equalled by any other gold mine in British Columbia. A steam pump is now in the course of construction on the property, and the work towards developing this mine is being pushed forward as quickly as possible. Ore shipments will be made as soon as ever the roads permit of travelling.

sometimes arbitrary.

It was the intention of the publisher to issue this work every two years, but the condition of the Manufacturing Industries in this country is so healthy that the few changes likely to occur within the next three years will not warrant another issue before January 1st, 1899.

The Elise Company yesterday sent out a full crew of men to begin working a double shift on the property. The water is all pumped out, and the shaft ready for sinking. A contract was let yesterday by the

to thank the Manufacturers for their continued confidence in which promises that the edition of 1899, shall be handled with increased vigour, and a firm determination to eclipse all former editions in representing and advancing the interest of Canadian Manufacturers and the products of Canada in all the Markets of the World.

Tuesday April 27th - 97  
THE MANUFACTURERS' LIST CO.

MONTREAL, QUE.

The loose stock of the Elise is reported to have been pooled. Two extensions of the Elise have been bonded.



# INDEX TO ADVERTISERS.

	PAGE.		PAGE.
Abbott, & Co., Montreal, Que . . . . .	196	Canada Machinery Agency, Montreal, Que. . . . .	250
Acadia Powder Co. Ltd., Halifax, N.S. . . . .	240	Canada Paint Co. Ltd. (The), Montreal, Que . . . . .	221
Acme Veneer Works (The), Orillia, Ont . . . . .	217	Canada Screw Co. Ltd., Hamilton, Ont. . . . .	226
Alabastine Co. Ltd. (The), Paris, Ont . . . . .	212	Canada Spring & Switch Co. Ltd. (The), Montreal, Que . . . . .	217
Albert Toilet Soap Co. (The), Montreal, Que . . . . .	248	Canadian Cork Cutting Co. (The), Montreal, Que. . . . .	223
American Copper Co. (The), Toronto, Ont . . . . .	157	Canadian Fire Extinguisher Co. Ltd. (The), Montreal, Que . . . . .	237
Ames-Holden Co. Ltd. (The), Montreal, Que . . . . .	228	Canadian Locomotive & Engine Co. Ltd. (The), Kingston, Ont . . . . .	175
Amherst Boot & Shoe Mfg Co. (The), Amherst, N.S. . . . .	229	Canadian Manufacturer (The), Toronto, Ont . . . . .	260
Ashley Carriage Works (The), Belleville, Ont . . . . .	204	Canadian Office & School Furniture Co. (The), Preston, Ont . . . . .	210
Atkinson, Henry, Etchemin, Que . . . . .	222	Canadian Photo Engraving Bureau (The), Toron- to, Ont . . . . .	239
Babcock & Wilcox Water Tube Steam Boiler Co. (The), Montreal, Que . . . . .	194	Canadian Rand Drill Co. (The), Sherbrooke, Que . . . . .	165
Bain Bros. Mfg Co. Ltd. (The), Brantford, Ont . . . . .	249	Canadian Rubber Co. (The), Montreal, Que . . . . .	197
Ballantine J. & Co., Preston, Ont . . . . .	205	Cane & Sons Mfg Co. (The Wm.), Newmarket, Ont. . . . .	218
Barber & Ellis Co. (The), Toronto, Ont . . . . .	192	Carrier, Laine & Co., Levis, Que . . . . .	150
Barber, Wm. & Bro., Georgetown, Ont . . . . .	169	Cascade Narrow Fabrick Co., Coaticook, Que . . . . .	188
Bateman, Wm. & Co., Montreal, Que . . . . .	247	Central Bridge & Engineering Co. Ltd., (The), Peterborough, Ont. . . . .	214
Bauer, A. & Co., Waterloo, Ont . . . . .	185	Century Co., Picton, Ont . . . . .	246
Beamsville Pressed Brick Co. (The), Beamsville, Ont. . . . .	215	Chadwick, Bros., Hamilton, Ont . . . . .	206
Beatty, M. & Sons, Welland, Ont . . . . .	173	Chalifoux, O. & Fils, St. Hyacinthe, Que . . . . .	232
Beaver File Works (The), Levis, Que . . . . .	241	Chapman, W. J., Wingham, Ont . . . . .	227
Belding, Paul & Co., Montreal, Que . . . . .	183	Chatham Mfg Co. Ltd. (The), Chatham, Ont . . . . .	245
Belleville Box & Basket Co. Ltd., Belleville, Ont . . . . .	234	Cheesebrough Mfg Co., Montreal, Que . . . . .	259
Berlin Suspender & Button Co. (The), Berlin, Ont . . . . .	185	Chown, W. W. & Co., Belleville, Ont . . . . .	233
Bertram (Jno.) & Sons, Dundas, Ont . . . . .	161	Christie, Bros. & Co., Amherst, N.S. . . . .	232
Biette & Co., Chesley, Ont . . . . .	240	Clappison Pipe & Boiler Covering Co. (The), Hamilton, Ont . . . . .	193
Bigley, R., Toronto, Ont . . . . .	242	Clare Bros. & Co., Preston, Ont . . . . .	243
Booth Copper Co. (The) . . . . .	155	Coddington, W. H., Hamilton, Ont . . . . .	183
Bramley, Wm., Montreal, Que . . . . .	236	Cook Hardware Co., Hamilton, Ont . . . . .	166
Brantford Starch Co., Brantford, Ont . . . . .	246	Cooper, Jas., Montreal, Que . . . . .	171
Brantford Stoneware Mfg Co. Ltd. (The), Brant- ford, Ont. . . . .	251	Cork Co. of Canada Ltd. (The), Montreal, Que . . . . .	187
Brown, Boggs & Co., Hamilton, Ont . . . . .	193	Corticelli Silk Co. Ltd., Montreal, Que . . . . .	182
Brown Mfg Co. Ltd. (The G. & J.), Belleville, Ont. . . . .	198	Coulter & Campbell, Toronto, Ont . . . . .	201
Bryan, Thos., London, Ont. . . . .	212	Cowan, Jno., Montreal, Que . . . . .	240
Buntin, Reid & Co., Toronto, Ont. . . . .	170	Cowan, O. D., Gananoque, Ont . . . . .	233
Button & Fessant, Wingham, Ont . . . . .	251	Crossen Car Mfg Co. Ltd. of Cobourg, Cobourg, Ont. . . . .	160
Campbell, Manson, Chatham, Ont . . . . .	252	Crossman & Laws, Amherst, N.S. . . . .	226
Campbell, R., Hamilton, Ont . . . . .	230	Davidson Mfg Co. (The Thos.), Montreal, Que . . . . .	225
Canada Axe & Harvest Tool Co. (The), St. Catha- rines, Ont . . . . .	241	De Cew, T. H., Essex, Ont. . . . .	214
Canada Bung & Spile Factory (The), Manotick, Ont . . . . .	248	Dennis Wire & Iron Works (The), London, Ont . . . . .	207
Canada Horse Nail Co. (The), Montreal, Que . . . . .	213		
Canada Iron Furnace Co. Ltd. (The), Montreal, Que. . . . .	206		
Canada Jute Co. (The), Montreal, Que. . . . .	225		

INDEX TO ARTICLES.

Caps,	No.	Cards,	No.	Cases,	No.
" Seal Skin	1507	" At Home	639	" Dry Goods (revolving)	666
" Uniform	1684	" Cotton Mill	636	" Egg	670
" Yacht	1684	" Felt Mill	636	" Fancy	669
" Vent (Iron)	623	" Playing	638	" Jewelers'	666
Capes, Fur	1507	" Programme	639	" Jewelry	669
" (Fur) Ladies	1507	" Sample	639	" Library Book	667
Capstans, Bar	627	" Shoddy Mill	636	" Liquor	676
" Crank	627	" Shew	639	" Mailing	672
" Hand and Horse	627	" Wool Mill	636	" Manicure	669
" Steam	627	" Visiting	639	" Medicine	669
Capsules, Bottle	628	" Wedding	639	" Merchandise (shipping)	676
" Cork	630	" Worsted Mill	636	" Organ and Piano	676
" Empty	632	Carettes, Street	653	" Packing (in shoeks)	671
" Filled	632	Carpets, Axminster	640	" Packing (shipping)	676
" Gelatine	631	" Hemp	641	" Photograph	669
" (Veneer) Bottle	629	" Ingrain	640	" Playing Card	669
" Quinine H. F.	632	" Jute	641	" Push	669
" Quinine S. E.	632	" Stair	640	" Rattan Book	675
Caramels	654	" Union	640	" Revolving Book	667
Cars, Acid Tank	650	" Venetian	641	" Scissors	669
" Baggage	650	" Wool	640	" Shaving	669
" Box	656	" Wool, "Imperial"	641	" Show	666
" Cable	651	Carriages, Vehicle	646	" Show, Grocers'	666
" Caboose	656	" Children's	645	" Show, Jewelers'	666
" Cattle	656	" Cone Coupler	643	" Show, Revolving	666
" Coal	656	" Coupe	646	" Toilet	669
" Coal Elevator	650	" Doll and Toy	645	" Vial	669
" Colonists	656	" Jump Seat	646	" Watch	667
" Construction	656	" Saw Mill	642	Casings, Metal Window	675
" Derrick	656	Carriers, Bundle	649	Caskets, Burial	679
" Dining	656	" Cash	649	" Cloth Covered	679
" Drawing Room	656	" Hay Sling	647	" Lead	678
" Drop Bottom	650	" Parcel	649	" Varnished	679
" Dump	650	" Trace	648	Cassimeres	680
" Electric	651	Carts, Coal	659	Casters, Bed	684
" Elevator, Passenger	655	" Corporation	659	" (wood) Sink	682
" Excursion	656	" Dog	661	" Furniture (iron)	682
" Flat	656	" Dump	659	" Glass	683
" Freight	656	" Express	663	" Piano and Organ	682
" Hand	650	" Hand	663	" Plate	684
" Live Stock	656	" Hose	663	" Plated	681
" Logging	650	" Merchants	663	" Spring Socket	684
" Mail	656	" Ox	659	" Table Slide	682
" Mill Yard	650	" Peddlers	663	" Truck	682
" Mine	650	" Perry	660	Castings, Agricu'tural Machinery	695
" Observation	656	" Post Office	663	" Art Brass	720
" Oil Tank	650	" Railroad (hand)	663	" Bakers' Oven	703
" Ore	650	" Railroad Contractors	659	" Barge	688
" Parlor, Horse	656	" Road	658	" Brass	720
" Passenger	656	" Speeding	658	" Bridge	718
" Pit	650	" Toy (metal)	662	" Bridge Pier	718
" Push	650	" Village	659	" Bronze	717
" Refrigerator	656	" Water	3209	" Building	716
" Road Masters'	656	Cartridges, Rifle	657	" Car	714
" Sleeping	656	" Metallic	657	" Carriage, Malleable	700
" Steam Shovel	652	" Shot Gun	657	" Chair	701
" Street Railway	651	Cascara, Stearn's Aromatic	664	" Church Seat End	701
" Superintendents'	656	Cases, Binding	666	" Coke Oven	703
" Track Layers'	656	" Biscuit (show)	666	" Copper	711
" Vestibule	656	" Book	667	" Derrick	709
" Wrecking	656	" Bicycle	674	" Elevator	713
Carbons, Electric Light	634	" Brush	669	" Engine	715
Carbonate of Copper	633	" Burial	668	" Flour Mill	712
" of Iron	633	" Cabinet Book	667	" Furnace	698
" of Magnesia	633	Cases, Card	2705	" Gas Works	699
" of Soda	633	" Cartridge	673	" Gray Iron	721
" of Zinc	633	" Caustic	669	" Gun Metal	722
Cardboard, Colored	635	" Cutlery	669	" Heavy Brass	720
" White	635	" Cylinder Book	667	" Heavy Iron	722
Cards, Advertising	639	" Dressing	669	" Incinerator	686
" Advertising, (tin)	637	" Dry Goods (shipping)	676	" Iron	722



INDEX TO ARTICLES.

Castings,	No.	Cement,	No.	Chairs.	No.
" Iron Furnace . . . . .	698	" Hydraulic . . . . .	744	" Commode . . . . .	768
" Journal (brass) . . . . .	691	" Leather . . . . .	742	" Dentists' . . . . .	758
" Light Iron . . . . .	721	" Patching (leather) . . . . .	742	" Folding . . . . .	769
" Lime Kiln . . . . .	685	" Napanee . . . . .	744	" Folding (wire) . . . . .	767
" Locomotive . . . . .	715	" Portland . . . . .	744	" Garden (iron) . . . . .	766
" Machinery (brass) . . . . .	693	" Retort, Asbestos . . . . .	55	" Hall . . . . .	772
" Machinery (iron) . . . . .	694	" Roofing . . . . .	741	" Invalid . . . . .	775
" Malleable Agricultural . . . . .	700	" Rosin (Reed's) . . . . .	737	" Invalid Rolling . . . . .	775
" Malleable, Hame . . . . .	719	" Rubber . . . . .	740	" Lawn (iron) . . . . .	766
" Mill Machinery . . . . .	712	" Rubber (patching) . . . . .	738	" Lawn (wire) . . . . .	767
" Office Chair . . . . .	692	" Star Brand . . . . .	744	" Library . . . . .	771
" Ornamental Brass . . . . .	720	" Stove . . . . .	734	" Lodge Room . . . . .	1508
" Phosphor Bronze . . . . .	706	" Street Paving . . . . .	743	" Office . . . . .	772
" Planing Mill . . . . .	712	Centers, Bench . . . . .	745	" (Office) Revolving . . . . .	772
" Plow . . . . .	696	" Compound . . . . .	745	" Opera . . . . .	772
" Railway Track . . . . .	708	" Index . . . . .	745	" Parlor . . . . .	1506
" Rolling Mill . . . . .	712	" Neck Yoke . . . . .	746	" Railway Car . . . . .	765
" Saw Mill . . . . .	712	" Planer . . . . .	745	" Railway Track Head . . . . .	764
" School Desk . . . . .	701	" Sash . . . . .	747	" Rattan and Reed . . . . .	774
" Sewing Machine . . . . .	690	Cerates . . . . .	748	" Reclining . . . . .	765
" Ship . . . . .	705	Cesspools, Gutter . . . . .	749	" Rocking (Jumbo) . . . . .	762
" Steam Barge . . . . .	686	" Stable . . . . .	749	" Rocking (Wilson's) Rug . . . . .	761
" Steel . . . . .	704	Chains, Boom . . . . .	755	" Rolling . . . . .	775
" Store Front . . . . .	716	" Brass Picture . . . . .	754	" Surgical . . . . .	758
" Stove . . . . .	710	" Bull . . . . .	755	" Swing . . . . .	774
" Street Car . . . . .	714	" Cable . . . . .	756	" Toy Wire . . . . .	767
" Street Railway Track . . . . .	708	" Cart Back . . . . .	756	" Veneer Patent . . . . .	759
" Tin . . . . .	687	" Chatelaine . . . . .	757	" Veneer Seat . . . . .	1506
" Water Works . . . . .	707	" Crane . . . . .	756	" Veranda . . . . .	762
" White Iron . . . . .	689	" Dog . . . . .	756	" Wire, Folding . . . . .	767
" Windmill . . . . .	702	" Drapery . . . . .	754	" Wood Seat . . . . .	770
" Zinc . . . . .	697	" Eye Glass . . . . .	757	Chamois, Fibre . . . . .	777
Catches, Barn Door . . . . .	724	" Filled Gold . . . . .	757	Chandeliers, Brass and Bronze . . . . .	778
Catches, Cupboard . . . . .	724	" Gauge . . . . .	750	" Combination . . . . .	778
" Screen Door . . . . .	724	" Gold . . . . .	757	" Church . . . . .	778
" Shaft Hold Back . . . . .	723	" Halter . . . . .	756	" Crystal . . . . .	778
" Transom . . . . .	724	" Hanging Basket . . . . .	756	" Electric . . . . .	778
Catheters, Rubber . . . . .	725	" Hitching Post . . . . .	756	" Gas . . . . .	778
Catsup, Mushroom . . . . .	726	" Jack . . . . .	752	" Hall . . . . .	778
" Tomato . . . . .	726	" Kennel . . . . .	756	" Extension . . . . .	778
" Walnut . . . . .	726	" Key . . . . .	754	" Lamp . . . . .	778
Ceiling, Corrugated . . . . .	730	" Log . . . . .	755	" Railway Car . . . . .	778
" Decorated Metal . . . . .	730	" Mining . . . . .	755	Charcoal . . . . .	877
" Iron and Steel . . . . .	730	" Necklace . . . . .	757	Channels, Steel . . . . .	779
" Metallic . . . . .	729	" Nickel . . . . .	757	Charms, Gold . . . . .	780
" Terra Cotta . . . . .	728	" Plated . . . . .	757	" Silver . . . . .	780
" Wood (dressed, matched) . . . . .	727	" Plumbers' . . . . .	754	" Society . . . . .	780
Cells, Battery (stone) . . . . .	731	" Pump . . . . .	756	" Watch . . . . .	780
Cement, Abutment . . . . .	743	" Railway . . . . .	755	Charts, Map . . . . .	781
" Acme . . . . .	744	" Rein . . . . .	756	Chases, Printing Press . . . . .	782
" Actinolite . . . . .	732	" Sash . . . . .	756	Chaucks, Ships . . . . .	788
" Aqueduct . . . . .	743	" Saw Mill . . . . .	755	Checks, (Baggage) Cloth & Paper . . . . .	784
" Arch Sewer . . . . .	744	" Silver . . . . .	757	" Baggage, Metal . . . . .	786
" Asbestos . . . . .	55	" Steel . . . . .	755	" Brass . . . . .	786
" Asphalt . . . . .	737	" Surveyors' . . . . .	753	" Bridle . . . . .	1751
" Belt . . . . .	742	" Trace . . . . .	756	" Cash Sale . . . . .	786
" Bicycle . . . . .	736	" Trace (wrought iron) . . . . .	751	" Hotel Key . . . . .	786
" Cellar Floor . . . . .	744	" Vest . . . . .	757	" Metal . . . . .	786
" Cistern . . . . .	744	" Wagon . . . . .	756	" Restaurant . . . . .	786
" Concrete . . . . .	744	" Waste . . . . .	755	" Shuttle (woollen mill) . . . . .	785
" Drain Pipe . . . . .	743	" Watch . . . . .	757	" Time . . . . .	786
" Earthenware . . . . .	739	Chairs, Adjustable . . . . .	773	Cheese. See Cheese Factory	
" Fire Proof . . . . .	733	" Antique . . . . .	768	Chemicals, Agricultural . . . . .	787
" Foundation . . . . .	743	" Assembly . . . . .	771	" Electro-Plating . . . . .	788
" Foundry . . . . .	733	" Barbers' . . . . .	761	" Heavy . . . . .	788
" Furnace . . . . .	733	" (Bamboo) Corner . . . . .	760	" Pharmaceutical . . . . .	787
" Furnace Asbestos . . . . .	55	" Bent Wood . . . . .	763	Cheques, Blank . . . . .	789
" Glassware . . . . .	739	" Camp . . . . .	769	Cherries, Canned . . . . .	611
" Gas Fitters' . . . . .	735	" Children's . . . . .	774	Chesterfield Ware . . . . .	3686
" Hot Blast . . . . .	733	" Church . . . . .	772	Chests, Bolting (mill) . . . . .	791

# Canadian Miner

## INDEX TO ARTICLES.

	No.		No.		No.
Chests,		Cigarettes, Cubeb	815	Cloaks,	
"  Iron	790	Circles, Brass	816	"  Infants'	855
"  (Tin) Tea	792	"  Miners' Dip	817	"  Ladies'	855
Cheviots, Cotton	793	"  of Caffine	586	"  Misses'	855
(Wool) Dress, See Dress		"  of Iron and Ammonium	818	Clocks, Locomotive	856
(Goods)	867	"  of Iron and Quinine	818	"  Marine	856
Canned	612	"  Magnesia	818	Closets, Automatic	859
Tributary to Quartz Creek is the well known		"  Potassium	818	"  Dry Earth	859
Elise mine on Wild Horse, with a pay streak		"  Compound	818	"  Water (ship & yacht)	857
18 inches to 3 feet wide and a shaft down 81		"  Adjustable	819	"  Water (iron)	858
feet and a cross-cut being made to cut the		"  Belts	823	Cloth, Asbestos	861
vein at a depth of 125 feet and connect with		"  Hose	827	"  Barley Mill	866
the shaft. Near the Elise are the Blackcock		"  Machinists'	919	"  Battery (wire)	865
and Ymir. On the latter about 1,000 feet of		"  Plow Colter	824	"  Bellows (rubber)	863
"  Firmer	796	"  Pump	821	"  Brass Wire	865
"  Ice	797	"  Quilt Frames	819	"  Bolting Wire	865
"  Mortiser	797	"  Sash, Door and Blind	820	"  Costume Plaid	867
"  Socket Paring	707	"  Screw	819	"  Hair	862
"  Stencil	795	"  Screw (wood)	825	"  Military (Ladies)	867
"  Stone	796	"  Tire Bolt	822	"  Shoe	867
Chisels, Track	796	"  Vise	819	"  Jersey	867
Chloride of Ammonium	29	"  Wood	825	"  Cashmerettes	867
"  of Antimony	37	Clapboards, Metallic, Steel	828	"  Cassimere	867
"  of Cadmium	799	"  (Wood)	826	"  Cheviots	867
"  of Calcium	799	Clasps, Corset	829	"  Cloaking	867
"  of Copper	799	"  Unbreakable Corset	929	"  Clover Mill	866
"  of Gold	799	"  Garment	830	"  Crimped Wire	865
"  of Iron	799	"  Horse Blanket	830	"  Diagonals	867
"  of Lead	798	Claws, Tack	831	"  Diaphanous Wire	869
"  of Potassium	799	Clay, Fire	833	"  Fanning Mill (wire)	866
"  of Silver	799	"  Foundry	832	"  Galvanized Wire	864
"  of Sodium	798	Cleaners, Boiler	836	"  Iron Mining	864
"  of Zinc	798	"  Boiler Flue	836	"  Turned Wire	864
Chocolate, (Drink)	888	"  Corn and Oat	834	"  Trousering	867
Chocolates, Confection	952	"  Drain Tile	835	"  Upholsterers' Hair	862
Choppers, Butchers'	801	Cleats, Boat	839	Cloth, Window Screen (Wire)	865
"  Grain	800	"  Electric Light	837	"  Loom (wire)	865
"  Meat	801	"  Line	838	"  Mantle	867
"  Vegetable	801	"  Wire Connector	837	"  Milton Serge	867
Chow Chow	802	Cleavers, Butchers'	840	"  Oatmeal Mill (wire)	866
Chromate of Iron	803	"  Pork Packers'	840	"  Organ (rubber)	863
Chucks, Car Wheel	806	Clevises, Chain	842	"  Paper Makers	860
"  Compound Circular	806	"  Evens	842	"  Patching (rubber)	863
"  Cutting off	806	"  Link	842	"  Phosphor Bronze	864
"  Drill	805	"  Wrought Iron	841	"  Plated Steel Wire	866
"  Lathe	804	Clinchers, Horseshoe Nail	843	"  Power Loom (wire)	865
"  Lathe, Combined	806	Clips, Axle	848	"  Rice (wire)	864
"  Eccentric	806	"  Axle "Timkin"	848	"  Roller Mill (wire)	866
"  Lathe, Independent	806	"  Bolt	849	"  Smut (wire)	864
"  Lathe, Turret	806	"  Carriage, Malleable	851	"  Spark (wire)	864
"  Lathe, Universal	806	"  Coach	848	"  Steel Wire	864
"  Planer	806	"  Curtain	847	"  Steamer (wire)	864
"  Cylinder	806	"  Felloe	848	"  Sugar (wire)	864
"  Screw Machine	805	"  Hame	846	"  Tailors' Padding (hair)	862
"  Self-Centering	806	"  Lose	853	"  Threshing Machine (wire)	866
"  Shaper	806	"  Iron and Steel	848	Clothing, Card Factory	871
"  Sliding Jaw	804	"  King Bolt	848	Clothing, Children's Rubber	872
"  Swivel Base	806	"  Paper	854	"  Firemen's Rubber	872
"  Wood Lathe	807	"  Niel Yoke	851	"  Horse, Oiled	869
Churns, Barrel	808	"  Saddle	852	"  Horse, Rubber	870
"  Dash	809	"  Side Bar	852	"  Macintosh	868
"  Factory	808	"  Special	852	"  Ready-Made	873
"  Patent Revolving	810	"  Spring	850	"  Sportsmen's Rubber	872
"  Power	808	"  Stationers'	850	"  Waterproof	868
"  Stoneware	811	"  Wrought Iron Yoke	852	Clubs, Indian	874
Chutes, Mail	812	Clippers, Bolt	844	Clutches, Friction	875
Cider, Apple	813	"  Dehorning	845	"  Spring	875
"  Champagne	813	"  Rivet	844	Coaches, Tally Ho	876
Cigars	814	Cloaks, Childrens'	855	Coal, Bituminous	878
		"  Fur	1507	"  Charred	877
				Coats, Black Dog Skin	881



INDEX TO ARTICLES.

	No.		No.		No.
Coats,		Collars,		Compound, Field Coil..	937
" Fur..	1507	" Stovepipe (brass)..	907	" Weather Proof Wire..	937
" Leather..	880	" Sweat..	909	" Boiler Cleaning..	936
" Matassana Fur..	1507	" Waterproof..	905	Composition, Roller..	933
" Oiled..	869	Collars and Cuffs (paper) Linen		Compressors, Air..	940
Coats, Rubber..	878	Faced..	911	" Bret Actuated..	940
Coating, Preservative..	879	Collectors, Dust..	912	" Gas..	940
" Wall..	879	Collets, Bit Brace..	913	" Steam..	940
Cocaine, Alkaloid..	882	Collodion..	914	Concentrations, (Medicinal)..	941
" Hydrobromate..	882	Colors, Agricultural..	919	Concentrators, Gold..	943
" Hydrochlorate..	882	" Aniline..	916	" Ore..	942
" Oleate..	882	" Artists' Dry..	918	Condensed Milk..	891
" Salicylate..	882	" Artists' Tube..	918	Condensers, Jet..	946
Cocks, Air..	886	" Bottlers..	915	" Keel..	946
" Ale and Beer..	886	" Car..	919	" Ammonia..	944
" Angle..	886	" Ceramic..	918	" Distilling (for ice ma-	
" Asbestos Packed..	886	" Chromo Photograph..	918	chine..	944
" Brass..	886	" Coach..	919	" Amalgam Retorts &	2790
" Compression..	886	" Confectioners'..	915	" Independent..	946
" Cylinder..	886	" Decorators'..	919	" Surface..	946
" Gas..	886	" Distemper..	919	Condensers and Air Pump, com-	
" Gauge..	886	" Dry..	919	bined..	947
" Gauge (marine)..	885	" Dry Mortar..	919	Condensers and Air Pumps, in-	
" Gauge (Self-Cleaning)..	885	" Fresco..	919	dependent..	945
" Gauge, Steam Boiler..	885	" Graining..	919	Conductors, Roof Water..	948
" Hose..	886	" Ham Canvas..	919	Cones, Bicycle..	949
" Iron..	885	" Japan..	919	" Blacksmiths'..	951
" Lamp Post..	885	" Marbleizers'..	919	" Friction..	950
" Lock..	886	" Mortar..	919	" Wire Rope..	950
" Self-Closing..	886	" Oil..	919	Confectionery, Speciaties..	952
" Shaft Hold (vehicle)..	884	" Paper Makers'..	919	Connections, Pump..	953
" Steam..	886	" Pulp..	919	Converters, Electric..	954
" Stop (brass)..	886	" Scene Painters' Dry..	918	Conveyors and Extractors, Saw	
" Stop (Imperial)..	887	" Soluble (Confectionery)..	915	Dust..	955
" Waste (brass)..	886	Colorings, Bottlers'..	920	Conveyers, Steel Spiral..	956
" Water (brass)..	886	" Burnt Sugar..	920	Cookers, Steam..	957
Cockeyes, Wrought Iron..	883	" Cheese and Butter..	921	Coolers, Candy..	959
Cocoa (drink)..	888	" Fruit..	920	" Milk..	958
" Condensed..	891	" Sugar..	920	" Potash..	960
Cocoanut, Dessicated and Shred-		" Vinegar..	920	" Water..	961
ded..	889	Columns, Boiler Plate..	925	Coops, Poultry (wire)..	962
Codes, Signal..	890	" Building (cast iron)..	926	Coping, Iron..	963
Coffee, Condensed..	891	" Cast Iron..	926	" Metal..	966
" Fluid..	892	" Iron..	925	" Stone..	964
" Ground..	3172	" Pump..	922	" Terra Cotta..	967
Coffins, Wood..	894	" Shaft..	927	" Wall..	965
Cogging, Wood..	895	" Steel..	924	Copper, Dynamo Brush..	970
Cogs, Maple..	895	" Store Front..	926	" Sheet..	968
Coils, Abdominal (rubber)..	898	" Tee Bar..	924	" Work..	972
" Box (iron)..	896	" Water (iron)..	925	Copperas..	969
" Brass..	901	" Wood..	923	Coppers, Soldering..	971
" Copper..	901	" Wrought Iron..	924	Cord, Asbestos..	55
" Induction..	899	Combinations (Ladies and Chil-		" Bell..	975
" Iron..	896	dren's)..	928	" Bell, Leather..	973
" Pipe..	896	Combinations, Ribbed Knitted		" Curtain..	975
" Pipe (wrought iron)..	897	Cotton..	928	" Flexible..	976
" Resistance..	900	Combinations, Ribbed Knitted		" Jute..	975
" Steam and Hot Water..	900	Wool..	928	" Picture..	975
Coilers, Barrel Hoop..	902	Combs, Metal..	929	" Sash..	975
" Hoop..	902	Comforters, Down (bed)..	930	" Shade..	975
Coke..	903	Compasses, Surveyors' (folding		" Tarred..	974
Collars, Bridge (iron and steel).	904	sight)..	932	" Telephone..	976
" Celluloid..	905	Compasses, Miners'..	932	Cords, Cotton..	978
" Clamp..	910	Commutators, Electric..	931	" Silk..	978
" Horse..	909	Compound, Cerebral Sedative..	939	" Hat..	978
" Horse (fire department)..	908	" Glycerole Yerbine..	939	" Mohair..	978
" Linen..	3047	Compound, Syrup Trifolium..	939	" Wire Sash..	977
" Mule..	909	" Core..	934	Cordage, Manilla and Sisal..	980
" Ox..	909	" Insulating Armature..	937	" Wire..	979
" Shaft..	910	" Insulatory..	938	Cordial, Coca..	982
" Stove Pipe (tin)..	906	" Washing..	935		

INDEX TO ARTICLES.

	No.	Covers,	No.		No.
Cordial,					
" Fluid Beef.. . . . .	981	" Gun.. . . . .	1035	Crossings, Railway (Diamonds)..	1065
" Kola.. . . . .	982	" Gutter.. . . . .	1031	Crows, Jim.. . . . .	1066
Cores, Armature and Magnet..	985	" Grain Stack.. . . . .	1036	Cruppers, Harness.. . . . .	1067
Cordials, Stearns's Kola.. . . .	983	" Hay Stack.. . . . .	1036	Crushers, Barley.. . . . .	1069
Cores, Apple.. . . . .	984	" Horse (rubber).. . . . .	1037	" "Blake".. . . . .	1068
Corks, Lettered.. . . . .	987	" Horse (oil duck).. . . . .	1038	" Beef Steak.. . . . .	1073
" Bottle.. . . . .	987	" Kettle.. . . . .	1030	" Clay.. . . . .	1071
Corkscrews.. . . . .	986	" Manhole.. . . . .	1027	" Corn and Cob.. . . . .	1069
Corn, Pop.. . . . .	988	" Piano and Organ (rubber)..	1037	" "Gate".. . . . .	1070
Cornices, Galvanized Iron.. . .	992	" Rubber.. . . . .	1037	" Grain.. . . . .	1074
" Iron.. . . . .	990	" Salvage (oil duck).. . . . .	1038	" "Jaw".. . . . .	1070
" Terra Cotta.. . . . .	991	" Salvage (rubber).. . . . .	1037	" Ore.. . . . .	1075
" Window.. . . . .	992	" Trunk.. . . . .	1035	" Plaster.. . . . .	1072
" Window (wood).. . . . .	989	" Wagon (oil duck).. . . . .	1038	" Portable.. . . . .	1076
" Window (metal).. . . . .	992	" Wagon (rubber).. . . . .	1037	" Rock and Stone.. . . . .	1076
Corsets, Abdomial.. . . . .	993	Coverings, Asbestos.. . . . .	1021	Crutches, Cripple.. . . . .	1077
" "E. T.".. . . . .	993	" Boiler and Pipe (For-		Crystal, Washing.. . . . .	1078
" "Featherbone".. . . . .	993	resters Patent).. . . . .	1023	Crystals, Soda.. . . . .	1079
" Nursing.. . . . .	993	" Boiler & Steam Pipe..	1025	Cues, Billiard and Tips.. . . . .	1080
Cosmetics, Vaseline.. . . . .	994	" Furniture (hair cloth)..	1022	Cuffs, Celluloid.. . . . .	905
Cots, Ambulance.. . . . .	995	" Magnesia Sectional..	1025	" Ladies'.. . . . .	3047
" Bamboo.. . . . .	1000	" Pipe (hair felt).. . . . .	1026	" Linen.. . . . .	3047
" Canvas.. . . . .	995	" Sectional.. . . . .	1025	" Paper (Linen Faced).. . . . .	911
" Finger.. . . . .	998	" Sectional Boiler (as-		" Waterproof.. . . . .	905
" Folding Camp.. . . . .	997	bestos).. . . . .	1024	Cultivators, Corn.. . . . .	1083
" Folding (wire).. . . . .	997	Crabs, Horse Power.. . . . .	1039	" Horse.. . . . .	1083
" Hospital (iron).. . . . .	996	Crackers, Butter, Oyster.. . . . .	1040	" Root.. . . . .	1083
" Iron.. . . . .	996	Cradles, Grain.. . . . .	1042	" Spring Tooth.. . . . .	1081
" Iron Folding.. . . . .	996	" Rattan.. . . . .	1043	Cultivators and Feeders, Com-	
" Jail (iron).. . . . .	996	" Reed.. . . . .	1043	bined.. . . . .	1082
" Reed.. . . . .	1000	" Wicker.. . . . .	1041	Cups, Automatic Rod.. . . . .	1089
Cotters, Spring.. . . . .	1001	Cranes, Bridge.. . . . .	1046	" Brass (Dentists).. . . . .	1084
" Cottolene".. . . . .	1002	" Cheese Factory.. . . . .	1045	" Communion.. . . . .	1087
Cotton, Knitting Colored.. . . .	1003	" Derrick.. . . . .	1046	" Crank Pin Grease.. . . . .	1085
" Knitting, Gray.. . . . .	1003	" Gantry.. . . . .	1046	" Cupping.. . . . .	1088
" Spool.. . . . .	1004	" Hand.. . . . .	1046	" Drinking, Fountain.. . . . .	1089
Couches, Rattan.. . . . .	1004	" Heavy Wagon.. . . . .	1048	" Eccentric.. . . . .	1089
Counters, Bank and Office.. . . .	1018	" Hydraulic.. . . . .	1046	" Elevator.. . . . .	1092
" Boot and Shoe.. . . . .	1017	" Ingot.. . . . .	1046	" Glass Oil.. . . . .	1093
" Revolution.. . . . .	1016	" Jib.. . . . .	1046	" Grease, Engine.. . . . .	1085
" Speed.. . . . .	1016	" Ladle.. . . . .	1046	" Metal, Oil.. . . . .	1093
" Store.. . . . .	1018	" Locomotive.. . . . .	1044	" Nickle (Dentists).. . . . .	1084
Counterpanes and Bedspreads..	1015	" Pillar.. . . . .	1046	" Rubber Force.. . . . .	1091
Countershafts.. . . . .	1019	" Rotary.. . . . .	1046	" Slide Top.. . . . .	1089
Countersinks.. . . . .	1020	" Swing.. . . . .	1046	" Spit.. . . . .	1084
Couplings, Bell Cord.. . . . .	1007	" Travelling.. . . . .	1046	" Tin.. . . . .	1090
" Belt.. . . . .	1010	Cranks, Bell.. . . . .	1048	Cups and Saucers, Plated.. . . . .	1086
" Carriage.. . . . .	1006	Crates, Banana.. . . . .	1050	" Curcuma.. . . . .	1094
" Clutch.. . . . .	1013	" Bee Shipping.. . . . .	1051	" Curler, Liquid Hair.. . . . .	1096
" Cut-Off.. . . . .	1013	" Berry.. . . . .	1049	" Curlers, Steel Hair.. . . . .	1095
" Face.. . . . .	1011	" Onion.. . . . .	1050	" Curtains, Bath (rubber).. . . . .	1098
" Flanged.. . . . .	1011	" Tomato.. . . . .	1050	" Chenille.. . . . .	1097
" Friction.. . . . .	1013	" Vegetable.. . . . .	1050	" Drapery.. . . . .	1097
" Friction Clutch Cut-Off..	1013	Cream, Evaporated.. . . . .	1052	" Hanging.. . . . .	1097
" Hose.. . . . .	1012	Creameries. See general list.		" Tapestry.. . . . .	1097
Couplings, Malleable.. . . . .	1007	Creasers, Blacksmith's Adze Eye..	1053	Cushions, Air (rubber).. . . . .	1102
" Pipe.. . . . .	1008	Creepers, Ice.. . . . .	1054	" Billiard Table.. . . . .	1099
" Pole.. . . . .	1005	Creosote.. . . . .	1055	" Buggy (spring).. . . . .	1105
" Pump Rod.. . . . .	1009	Crestings, Iron Roof.. . . . .	1057	" Carriage.. . . . .	1100
" Shaft.. . . . .	1005	" Terra Cotta.. . . . .	1056	" Chair, Pneumatic (rub-	
" Universal Joint.. . . . .	1013	Cribs, Iron.. . . . .	1059	ber).. . . . .	1104
Covers, Barrel (wood).. . . . .	1032	" Folding.. . . . .	1058	" Church.. . . . .	1106
" Barrel (wire).. . . . .	1033	" Rattan.. . . . .	1043	" Cork Canoe.. . . . .	1103
" Billiard Table.. . . . .	1099	" Reed.. . . . .	1043	" Down.. . . . .	1101
" Boat and Sail.. . . . .	1036	" Wire.. . . . .	1059	" Fancy.. . . . .	1101
" Book, Adjustable.. . . . .	1034	" Folding, Wire Mattress..	1058	" Passenger Car.. . . . .	1105
" Cesspool.. . . . .	1031	Crimpers, Boot and Shoe.. . . . .	1061	" Railway Car (spring)..	1105
" Coal Hole.. . . . .	1027	" Blind Slat.. . . . .	1060	" Vehicle.. . . . .	1100
" Cylinder.. . . . .	1028	" Metal Power.. . . . .	1062	" Wagon.. . . . .	1100
" Fishing Rod.. . . . .	1035	Crocks, Butter and Milk.. . . . .	1064	Cuspadores, Brass.. . . . .	1107
Covers, Grave.. . . . .	1029	Cross Arms, Telegraph.. . . . .	1063	" Copper.. . . . .	1107



INDEX TO ARTICLES.

	No.		No.		No.
Cuspadores,		Derrick's		Ditchers,	
“ Iron . . . . .	1109	“ Ore . . . . .	1151	“ County . . . . .	1188
“ Nickel . . . . .	1107	“ Pile Driving . . . . .	1151	“ Canal . . . . .	1188
“ Self-Righting . . . . .	1107	“ Revolving, Steam . . . . .	1151	“ Railroad . . . . .	1188
“ Tin . . . . .	1108	“ Stationary . . . . .	1151	“ Steam . . . . .	1188
Cuts, Printers' . . . . .	1131	“ Travelling . . . . .	1151	“ and Excavators . . . . .	1188
“ Wood . . . . .	1131	“ Wrecking . . . . .	1151	Dogs, Cant . . . . .	1190
Cutters (Vehicle) . . . . .	1112	Designs, Wire Floral . . . . .	1159	“ Clamp . . . . .	1100
“ Axle . . . . .	1110	“ Wood . . . . .	1158	“ Die . . . . .	1189
“ Bolt . . . . .	1113	Designings (for Illustration) . . . . .	1160	“ Lathe . . . . .	1192
“ Boiler Tube Scale . . . . .	1129	Desks, Cabinet Writing . . . . .	1153	“ Malleable Lathe . . . . .	1191
“ Chaff . . . . .	1128	“ Cylinder . . . . .	1155	“ Saw Mill . . . . .	1190
“ Corn Stalk . . . . .	1128	“ Ladies' Writing . . . . .	1153	Domes, Glass . . . . .	1193
“ Ensilage . . . . .	1128	“ Library . . . . .	1153	Doors, Boiler . . . . .	1197
“ Epicycloidal . . . . .	1111	“ Music . . . . .	1154	“ Box Stall . . . . .	1196
“ Hay and Straw . . . . .	1128	“ Office . . . . .	1155	“ Brick Kiln . . . . .	1197
“ Involute . . . . .	1111	“ Roll Top . . . . .	1155	“ Building . . . . .	1195
“ Lever Feed . . . . .	1126	“ School . . . . .	1156	“ Cemetery Vault . . . . .	1195
“ Meat . . . . .	1121	“ School, Automatic . . . . .	1152	“ Fire Proof . . . . .	1195
“ Milling . . . . .	1125	“ School "Globe" . . . . .	1152	“ Iron . . . . .	1195
“ Mower and Reaper . . . . .	1117	“ Teachers' . . . . .	1152	“ Jail . . . . .	1195
“ Paper, Hand . . . . .	1122	“ Tin Coffee . . . . .	1157	“ Mahogany (plain) . . . . .	1198
“ Peg . . . . .	1124	Detectors, Low Waters . . . . .	1161	“ Panel . . . . .	1200
“ Pipe . . . . .	1123	Detonators . . . . .	1165	“ Raised Panel . . . . .	1200
“ Pipe, Hand . . . . .	1127	Devices, Oiling Crank Pin . . . . .	1162	“ (Screen) Framed . . . . .	1199
“ Rack, Automatic . . . . .	1111	Diapers, Rubber . . . . .	1163	“ Soot . . . . .	1194
“ Rule and Lead . . . . .	1122	Diaphragms, Rubber . . . . .	1164	“ Stable . . . . .	1196
“ Sausage Meat . . . . .	1121	Diaries, Office . . . . .	1165	“ Sweep Hole . . . . .	1194
“ Saw Gummer . . . . .	1127	“ Pocket . . . . .	1165	“ Vault . . . . .	1195
“ Solder . . . . .	1130	Dies, Adjustable Round . . . . .	1169	Drawers, Balbriggan . . . . .	3046
“ Sole Leather . . . . .	1119	“ Bit Brace . . . . .	1160	“ (Cotton) Ribbed Knit-	
“ Stable . . . . .	1130	“ Blacksmiths' . . . . .	3282	ted . . . . .	1201
“ Stave . . . . .	1120	“ Blanking . . . . .	1171	“ Ladies & Children's . . . . .	1201
“ Straw . . . . .	1128	“ Bolt . . . . .	1160	“ Money . . . . .	1202
“ Tobacco . . . . .	1118	“ Boot and Shoe . . . . .	1173	Dredges, Boom . . . . .	1203
“ Twine . . . . .	1117	“ Brass . . . . .	1170	“ (Clam Suction) . . . . .	1203
“ Vegetable . . . . .	1116	“ Canners' . . . . .	1171	“ Dipper . . . . .	1203
“ Weed . . . . .	1115	“ Chilled Iron . . . . .	1172	“ Ditching . . . . .	1203
“ Wire . . . . .	1114	“ Chromo Steel . . . . .	1172	“ Grappler . . . . .	1203
Cylinders, Brass . . . . .	1135	“ Copping . . . . .	1171	“ Hydraulic . . . . .	1203
“ Brass Lined . . . . .	1136	“ Drawing . . . . .	1171	“ Spoon and Elevator . . . . .	1203
“ Copper . . . . .	1135	“ Drop . . . . .	1167	“ Steam . . . . .	1203
“ Deep Well . . . . .	1136	“ Hat Tip . . . . .	1170	Dress Goods, Silk . . . . .	3088
“ Dyeing . . . . .	1138	“ Leather Cutting . . . . .	1173	“ Woollen . . . . .	1204
“ Engine . . . . .	1137	“ Jewelers' . . . . .	1166	Dresses, Infants' . . . . .	1203
“ Iron . . . . .	1137	“ Ore Crushing . . . . .	1172	Dressers, Buhr Stone . . . . .	1206
“ Iron Lined . . . . .	1136	“ Shoe Cutting . . . . .	1173	“ Emery Wheel . . . . .	1206
“ Locomotive . . . . .	1137	“ Soap . . . . .	1170	“ Emery Wheel ("Hun-	
“ Oil Well . . . . .	1136	“ Solid Round . . . . .	1160	tingdons") . . . . .	1207
“ Pump . . . . .	1134	“ Stamp . . . . .	1170	“ Hoop . . . . .	1205
“ Shallow Well . . . . .	1136	“ Steel . . . . .	1176	“ Stave . . . . .	1205
“ Soldering . . . . .	1133	“ Stencil . . . . .	1168	Dressing, Belt . . . . .	1210
Cyanide of Mercury . . . . .	1132	“ Stocks & . . . . .	3282	“ Boot (liquid) . . . . .	1209
Dams, Dental . . . . .	1141	“ Ticket Punch . . . . .	1174	“ Harness . . . . .	1209
“ Steel . . . . .	1142	“ Tanners' . . . . .	1171	“ Liquid . . . . .	1209
“ Swing . . . . .	1142	“ and Punches (steel) . . . . .	1175	“ Shoe, Liquid . . . . .	1209
“ Movable . . . . .	1142	“ and Taps . . . . .	3429	Dressings, Tan . . . . .	1209
Dampers, Furnace . . . . .	1140	Digestive Ferments . . . . .	1176	Drills, Automatic . . . . .	1211
“ Stovepipe . . . . .	1139	Diggers, Post Hole . . . . .	1177	“ Bell Hangers' . . . . .	1215
Dashboards, Wicker . . . . .	1143	“ Potato . . . . .	1178	“ Bench . . . . .	1211
Dashes, Buggy . . . . .	1144	Dilators, Rubber . . . . .	1179	“ Blacksmith . . . . .	1219
Daubers, Shoe . . . . .	1145	Dippers, Copper . . . . .	1180	“ Bit Brace . . . . .	1218
Pecking, Ship . . . . .	1146	Dishes, Butter (oval) . . . . .	1182	“ Bit Stock . . . . .	1218
Decorations, Ceiling . . . . .	1147	“ Glass . . . . .	1181	“ Boiler Shell . . . . .	1216
“ Fibrous . . . . .	1147	“ Soap (iron) . . . . .	1183	“ Bow . . . . .	1215
“ Plaster . . . . .	1147	“ (Venecr) Butter . . . . .	1184	“ Breast . . . . .	1215
“ Wall . . . . .	1147	“ (Venecr) Lard . . . . .	1184	“ Center . . . . .	1218
Delacatine . . . . .	1148	Disks, Harrow . . . . .	1185	Drills, Power . . . . .	1214
Demijohns, Glass . . . . .	1149	Distributers, Fire Clay . . . . .	1186	“ Compressed Air . . . . .	1217
Denims, Cotton . . . . .	1150	“ Fire Place . . . . .	1186	“ Cone . . . . .	1214
Derricks, Construction . . . . .	1151	“ Gas . . . . .	1186	“ Coopers' Dowel . . . . .	1218
“ Mining and Quarry . . . . .	1151	Ditchers, Automatic Tile . . . . .	1187	“ Diamond . . . . .	1217

# Clippings from News.

## INDEX TO ARTICLES.

Drills	No.	Dusters	No.	Elevators	No.
" <i>Red Apl. 14/1897</i>	1210	Bran	1236	" Grain	1262
" Flute	1218	" Carriage	1235	" Hand Power	1261
In the Wild Horse.		" Feather	1235	" Hydraulic	1261
There is now a great showing of good grade ore on the Dundee, in the Wild Horse Creek camp.		" Furniture	1235	" Passenger	1265
The Elise is reported to be looking splendid, being all ore at the bottom of the shaft. A great boom is prophesied for Wild Horse Creek during the coming summer. The results of development work this winter have been remarkable.		" Muolders	1235	" Saw Dust	1266
" ery	1216	" Painters	1235	" Sidewalk (hand)	1264
" Mining	1219	" Parlor and Mantel	1235	" Steam Hod	1263
" Triple Spindle	1216	" Rag	1237	" Steam Power	1261
" Portable	1218	" Waste	1237	" Street Car	1261
" Prospecting Core	1214	" Wool	1237	" Tank System	1260
MINING NOTES.		" es, Aniline	1238	" Warehouse	1265
(From the Rossland Miner.)		" stuffs	1238	Elixir of Calisaya	1267
" W. R. Craig, of the Mannamead, which is on the north fork of the Salmon, writes to the company that the		Dynamos, Alternating Current	1240	Elixirs, Kola Compound	1268
" gang has struck a fine-looking ledge about 25 feet in. He says it is 20 inches in width, and carries galena, iron, and copper.		" Arc Lighting	1240	" Pepsin Lactated	1268
" Sensitive	1211	" Copper Refining	1240	Emblems, Masonic and Society	1270
" Shank	1219	" Drill	1240	" Terra Cotta	1269
" Spoon Bit	1218	" Electro Plating	1240	Embroideries, Bullion	1271
" Steam	1217	" Electrotyping	1240	" Gold and Silver	1271
" Steel Wire Gauge	1218	" Incandescent Lighting	1240	" Name and Letter	1271
" Stone	1217	" Marine	1240	" Swiss	1272
" Straight or Taper Shank	1218	" Power	1240	Emerv	1273
" Straightening	1219	" Railway	1240	Emetic, Tartar	3436
" Suspension	1211	" Telegraph	1240	Emulsion of Cod Liver Oil	1274
" Tap	1219	" Kettle (brass)	1241	" Puttner's	1275
" Taper	1218	" Coal Hod	1242	Enamel, Bicycle	1277
" Traverse	1211	" Kettle and Pail (iron)	1242	" Elastic	1277
" Twist	1219	" Tea Kettle (iron)	1242	" Stovepipe	1276
" Upright	1211	" Earphones, Metal	1243	Enclosures, Elevator	1278
" Wood Boring	1218	" Earthenware, Plumbers	1244	Ends, Bolt	1279
Drill and Roller Combined (seed)	1220	" Sanitary	1244	" Cylinder (brass)	1282
Drivers, Pile	1222	Easels, Bamboo	1247	" Iron Church Pew	1280
Drops, Cough	952	" Brass	1245	" Joint	1281
Droppers, Medicine	1223	" Enamelled	1247	" Pole	1283
Drum, Patent Stovepipe	1224	" Gold Finished	1247	" Stay	1281
Drums, Bass	1225	" Rattan	1247	" Wood Church Pew	2454
" Conical	1226	" White	1247	Engines, Armstrong	1289
" Cylindrical	1226	" Wire	1246	" Automatic Coal Oil	1286
" Hoisting	1226	Economizers, Fuel	1248	" Automatic Cut-Off	1288
" Orchestra	1225	Edges, Straight Saw	1253	" Automatic Cut-Off (Cor-	1285
" Kettle	1225	" Straight, (steel)	1253	liss)	1285
" Mud	1226	" Straight (wood)	1254	" Automatic Cut-Off	1287
" Rope Driving	1226	Edgers, Box (power feed)	1250	(Wheelock)	1287
" Snare	1225	" Double	1252	" Direct Coupled	1305
" Winding	1226	" Gang	1251	" Blast	1308
Dryers, Japan	1229	" Gang Saw	1252	" Blowing	1308
" Liquid	1229	" Lumber	1252	" Cheese Factory	335
" Paper and Pulp	1228	" Turf	1249	" Comopund Condensing	1288
" Transparent	1229	Edgings, Leather	1255	" Compound Horizontal	1300
" Wool	1227	Eff. rvescent Preparat ons (granu-		" Compound Marine	1307
Duck	1231	lar)	2610	" Corliss Steam	1303
" Enamelled (cotton)	1230	Eggs, Preserved	3848	" Electric Lighting	1284
" Fancy (cotton)	1231	" Fresh	3849	" Farm, Straw Burning	1299
" Oiled (cotton)	1230	Ejectors	1256	" Fire	1309
Dumpers, Furnace	1232	" Gem	1257	" Fire (Rotary)	1309
Dust, Cork	1233	" Hancock	1257	" Gas	1296
" Marble	1234	Elbows, Pipe	2491	" Grist Mill	1306
Dusters	1235	" Pipe (patent one piece)	2493	" Hauling	1298
		" Stovepipe	2491	" High Speed Automatic	1288
		Electroliers, Car	1258	" High Speed Horizontal	1300
		Electrotypes	1259	" High Speed Vertical	1300
		Elevators, Barrel	1261	" High Speed (Arming-	
		" Carriage	1261	ton & Sim's)	1297
		" Coal	1263	" Hoisting	1298
		" Compression System	1260	" Hoisting, Duplex	1298
		" Electric	1265	" Hoisting, Friction	1298
		" Direct Pumping Sys-		" Launch	1304
		tem)	1260	" Marine	1306
		" Factory	1265	" Marine Patent	1308
		" Flour Mill	1262	" Mining	1298
		" Freight	1265	" Portable, on Skids	1298

INDEX TO ARTICLES.

Engines,	No.	Escutcheons,	No.		No.
" Portable, on Wheels..	1298	" Drawer (walnut)..	1320	Eyelets, Carriage..	1353
" Pumping..	1306	" Keyhole..	1319	Eyes and Hooks, Gate..	1757
" Quarry..	1298	" Sliding Door..	1319	Eyes, Neck Yoke..	1351
" Reversing..	1307	Esencia de Calisaya..	1321	" Pole and Shaft..	1351
" Robb..	1289	Esencia de Coca..	1321	Face Plates..	2530
" Rolling Mill..	1306	Essences, Flavoring..	1322	Facings, Foundry..	1361
" Saw Mill..	1306	Etchings, Scroll (wood)..	1323	Fancy Work, Indian..	1354
" Side Crank..	1301	" Zinc..	1324	Fans, Advertising..	1357
" Slide Valve Saw Mill..	1302	Ether, Nitrous..	1325	" Elevator..	1359
" Stationary..	1300	" Nitrous (concentrated)..	1326	" Electric..	1358
" Stationary (horizontal)..	1300	" Sulphuric..	1325	" Exhaust..	1356
" Stationary (vertical)..	1300	Etoffes..	1327	" Hot Blast..	1355
" Steamboat..	1307	Enthymol..	1328	" Suction..	1356
" Straight Line..	1302	Evaporators, Cider..	1329	" Wire Dick..	1360
" Threshing (portable)..	1299	Evaporators, Jelly..	1329	Fasteners, Bedstead..	1367
" Traction..	1299	" Maple Sugar..	1329	" Conductor Pipe..	1363
" Vertical Portable..	1299	" Sap..	1329	" Belt..	1363
" Water Works..	1306	" Sorghum..	1329	" Corrugated, " Starr "	
" Winding..	1298	Eveners, Sole (boot and shoe)..	2119	" Patent..	1366
" Winding (double and single cylinders)..	1298	Excavators, Steam..	1330	" Curtain, Vehicle..	1362
" Yacht..	1304	" and Ditchers..	1330	" Door..	1942
" and Boilers, Portable..	357	Excelsior..	1331	" Glove Spring..	1365
" and Boilers, Drilling, Portable..	1290	Exhauster, Can..	1332	" Hook..	1364
" and Boilers, Drilling, Semi-portable..	1290	Expanders, Boiler Tube..	1333	" Refrigerator..	1942
Engravings, Bill Head..	1295	Expectorant, Anodyne Pine..	1334	" Sash..	1942
" Colored Plate..	1291	" Anodyne Pine (with tar)..	1334	" Seat..	1942
" Commercial, Steel..	1295	Exploders and Explosives..	1335	Faucets, Brass..	1368
" Copper Plate..	1295	Explosives, Roberite..	1335	" Bung..	1368
" Government..	1292	Exterminators, Insect..	1337	" Iron..	1369
" Half Tone..	1311	Extinguishers, Fire..	1338	" Lock..	1368
" Letter Head..	1295	Extract, Malt..	1346	" Petroleum..	1369
" Music..	1294	Extracts, Bark..	1348	" Self-closing..	1368
" Photo..	1292	" Bottlers..	1343	" Self-measuring..	1369
" Process..	1295	" Buchu Fluid..	1348	" Whey..	1369
" Wax..	1293	" Confectioners..	1343	" Wooden..	1369
" Wood..	1310	" Cooking Flavoring..	1343	Feed and Flour Merchants of Quebec & Maritime Prov..	3347
" Zinc..	1291	" Dyewood..	1344	Feeds, Automatic Shake..	1374
Envelopes, Commercial..	1312	" Flavoring..	1343	" Friction Carriage..	1375
" Catalogue..	1313	" Fluid..	1347	" Rotary Gang Saw Mill..	1375
" Clasp..	1313	" Fluid Assayed..	1349	" Steam Saw Carriage..	1375
" Cloth Lined..	1313	" Fluid Cascara Aromatic..	1349	Feeders, Bee..	1370
" Document..	1312	" Logwood..	1344	" Boiler..	1371
" Drug..	1313	" Malt Feratel..	1346	" Ore..	1372
" Embossed..	1312	" Malt with Cascara..	1346	" (Self)-Grain..	1373
" Express..	1313	" Malt with Beef Pepton..	1346	Felloes, Wheel..	3809
" Glove..	1312	" Malt with Ced Liver Oil..	1346	Felt, Asbestos..	55
" Government..	1312	" Malt with Hypophos- phites..	1346	" Building..	1376
" Manilla..	1313	" Malt with Iron, Quinine and Strychnine..	1346	" Chemical Sheeting..	1378
" Metal..	1313	" Malt with Pepsin and Pancreatin..	1346	" Carpet..	1376
" Mourning..	1312	" Malt with Yerba Sauta..	1346	" Dry..	1376
" Official..	1312	" Medicinal..	1341	" Paper Makers' Dryer..	1380
" Pay..	1312	" Powdered..	1347	" Paper Mill..	1380
" Photograph..	1313	" Solid..	1347	" Printers' Apron..	1380
" Printed..	1313	" Soluble..	1345	" Printers' Endless..	1380
" Railway..	1312	" Tonka..	1345	" Pulp Mill..	1380
" Sample..	1313	" Vanilla..	1345	" Refrigerator..	1378
" Seed..	1313	" Witch Hazel..	1348	" Roofing..	1378
" Tag..	1313	" Witch Hazel, Concen- trated Distilled..	1347	" Sock..	1379
" Tie..	1313	Extractors, Cheese..	1342	" Tarred..	1378
" Waterproof..	1313	" Honey..	1339	" Waterproof..	1376
Epergnes, Plated..	1314	" Hydraulic..	1341	Fence, Iron..	1383
Equalizers, Stave..	1315	" Stone and Stump..	1340	" (Locked) Wire..	1382
Equipments, Electric Railway..	1316	" Wax..	1339	" (Locked) Steel Wire..	1382
Ergotin..	1317	Eyebars, Bridge..	1352	" (Picket) Fancy Wood..	1384
Escapes, Fire..	1318			" Picket Iron..	1383
" Fire (folding)..	1318			Fencing, Galvanized Wire..	1381
Escutcheons, Door..	1319			" Barb Wire..	1386
" Drawer..	1319			" Barb Wire (Safety)..	1388
				" Corrugated Iron..	1387
				" Sheet Metal..	1387

INDEX TO ARTICLES.

Fencing,		No.	Flannels,		No.			No.
"	Steel	1386	"	Dress	1421	Forks,	Barley	1460
"	(Wire) Fancy	1381	"	Fancy	1421	"	Farm	1460
"	Wire	1385	"	Fine	1421	"	Hay (Steel)	1460
"	Wire Railway	1381	"	Gray	1420	"	Hay (Double Harpoon)	3128
"	Woven Wire	1381	"	White	1420	"	Manure	1460
"	Wrought Iron	1389	Flashing Roof		1422	"	Olive and Pickle, Wire	3092
Fenders, Brass		1391	Flasks, Powder (Tin)		1423	"	Potato	1460
"	Cork Boat	1392	Flat Ware, Plated		1425	"	Plated Wire	3092
"	Carriage	1393	"	Sterling	3092	"	Silver Plated	3092
"	Iron	1390	Flatters		1424	"	Spading	1460
"	Wire	1390	Flax, Hackled		1426	"	Sterling Silver	3092
"	Yacht	1392	"	Scutched	1426	"	Table	3092
Ferratin, B. & S.		1395	"	Upholsterers	1427	"	Vegetable	1460
Ferments, Digestive		1176	Flights, Conveyer		1428	Formers, Machine		1463
Ferrules, Iron		1394	Floats, Cork Thermometer		1429	"	Corrugating	1463
"	Neck Yoke	1394	"	Fisherman's	1429	"	Eventrough	1463
"	Tool Handle	1394	"	Fish Line and Net	1429	"	Stove Pipe	1463
"	Whiffletree	1394	"	Water Closet	1430	"	Metal Table	1463
Fertilizers, Land		1395a	Flock, Cotton		1432	"	Wire Ring	1463
Fibre, Asbestos		1397	"	Wool	3281	Forms, Blank Note		1461
Fibre Ware Indurated		1396	Flooring, Fireproof (Flue)		1434	"	Blank Receipt	1461
Figures, Brass		1398	Floors, (Kiln) Perforated Metal	1433	"	Coat, (Wire)	1462	
"	Copper	1398	"	Slate	1435	"	Dress, (Wire)	1462
"	Steel	1398	Flooring, Car		1436	"	Dummy (Wire)	1462
Filers, Emery, Band Saw		1399	"	Fireproof (Steel)	1434	Foundations, Honey Comb		1464
"	Saw	1400	"	Hard Wood	1437	Fountains, Drinking (Iron)		1466
Files, Auger		1403	"	Parquet	1436	"	Lawn & Park (Iron)	1466
"	Axle	1403	"	Rubber	1438	"	Soda Water	1465
"	Bastard	1402	"	(Matched) Hard Wood	1436	Founts, Lamp, (Glass)		1467
"	Blacksmiths'	2750	"	(Matched) Soft Wood	1436	Frames, Advertising (Wood)		1468
"	Bone	1402	Floss, Silk		3088	"	Band Saw Brazing	1480
"	Brasswork	1402	Flour, Wheat		1439	"	Bonnet	1683
"	Brush	1402	"	Export	1439	"	Buck Saw	1479
"	Carriage Makers'	2750	"	Graham	1439	"	Door and Window	1473
"	Flat and Round	1402	"	Self-Raising	1439	"	Furniture	1470
"	Hame Makers'	1402	"	Strong Bakers'	1439	"	Gilt	1468
"	Iron Work	1402	"	Special Brands	1440	"	Grindstone	1471
"	Jewelers'	1403	Flue Linings, Chimney		1441	"	Hat	1683
"	Mowing Machine	1403	Fluid Beef, "Johnston's"		210	"	Iron & Steel Building	1484
"	Office	1401	Fluids, Writing		1799	"	Locomotive	1481
"	Saw	1402	Flumes (Iron and Steel) Water		1442	"	Lounge	1477
"	Saw Work	1402	Fluters, Laundry		1443	"	Numeral	1475
"	Square	1402	Fobs, Gold and Silver		1444	"	Photograph (Wood)	1468
"	Stub	1403	Foil, Gold		1446	"	Picture	1468
"	Woodwork	1402	"	Tin (Bottle)	1445	"	Register, (Cast)	1472
"	Veterinary	1403	Folders, Bread Pan		1447	"	Register, (Slate)	1478
Fillers, Can		1405	"	Roofing	1447	"	Ship Stern	1476
Fillers, Capsule (Acme Raymond)	1811		"	Sheet Iron	1447	"	Street Lamp (Iron)	1483
"	Egg Case	1404	"	Square Box	1447	"	Ventilator (Iron)	1474
"	Lamp	1405	"	Tin	1447	Freezers, Ice Cream		1489
"	Oil Can	1405	"	Turners and Roofers	1447	Fret Work, Moorish		1487
"	Wood	2384	Folios, Blank		1448	"	Oak	1488
Filling, Rubber Pulley		1406	"	Music	1448	"	White and Enamelled Gold	1488
Filters, Stone		1408	Food, Cattle (Medicinal)		1449	"	Window	1488
Filters, Water (Household)		1407	Foods, Horse		1449	Frieze (Overcoatings)		1327
Fingers, Artificial		1994	"	Poultry	1449	Friezes, Plaster Composition		1485
"	Cradle	1409	"	Infant and Invalid	1450	"	Relief	1486
Finials, Iron		1412	Forges, Portable		1451	Frogs, Coopers'		1490
"	(Wood)	2728	Forgings, Bicycle, Steel		1455	"	"Patent Clamp"	1491
"	Terra Cotta	1410	"	Brass	1453	"	Railway Track	1492
Finish, Potato Bug		1413	"	Car	1456	"	Spring	1491
Fireworks		1431	"	Carriage	1452	"	Switch	1492
Firkins, Butter		1414	"	Drop, Copper	1454	Fronts, Bridle (Brass)		1495
Fish, Cod (boneless)		1415	"	Drop, Iron	1454	"	Boiler	1497
"	Cod (dried)	1416	"	Heavy	1456	"	Boiler Fire	1497
Flags of all Nations		1417	"	Lock	1456	"	Bridle (Brass)	1495
Flags, Yacht		1417	"	Locomotive	1456	"	Bridle (Leather)	1494
Flanges (iron) Plumbers'		1418	"	Railway	1456	"	Building (Metallic)	1493
"	Rubber	1419	"	Special	1456	"	Building (Iron)	1496
Flanlettes		1421	"	Steel	1454	"	Grate	1494
Flannels, Blue		1420	"	Wrought Iron	1456			



INDEX TO ARTICLES.

	No.		No.		No.
Fronts,		Gates,		Glass,	
" Oven (Bakers') . . . . .	1497	" Cantilever (Wood) . . . . .	1525	" Bent . . . . .	1555
" Store (Iron) . . . . .	1496	" Cemetery . . . . .	1528	" Blown . . . . .	1555a
Fruits, Canned . . . . .	611	" Cheese Vat . . . . .	1530	" Bevelled . . . . .	1555
Funnels, Copper . . . . .	1501	" Creamer . . . . .	1524	" Cheval . . . . .	1555
" Glass . . . . .	1499	" Crossing (Railway) . . . . .	1526	" Colored . . . . .	1555
" Rubber . . . . .	1498	" Elevator (Iron) . . . . .	1528	" Cut . . . . .	1555
" Ships' . . . . .	1500	" Farm . . . . .	1526	" Enamelled . . . . .	1555
Fur Boas . . . . .	1507	" Railway (Wire) . . . . .	1531	" Flint . . . . .	1555
" Capes . . . . .	1507	" Fence (Wire) . . . . .	1531	" Ground . . . . .	1555
" Caps . . . . .	1507	" Molasses . . . . .	1527	" Jewelled . . . . .	1555
" Cloaks . . . . .	1507	" Molasses . . . . .	1527	" Mirror . . . . .	1555
" Coats . . . . .	1507	" Molasses, Self-Boring . . . . .	1527	" Mosaic . . . . .	1555
" Garments . . . . .	1507	" Oil . . . . .	1524	" Ornamental . . . . .	1555
" Goods . . . . .	1507	" Railway . . . . .	1531	" Pressed . . . . .	1555
" Hats . . . . .	1507	" Vault (Iron) . . . . .	3649	" Stained . . . . .	1555
" Lined Coats . . . . .	1507	" Water Works . . . . .	1529	Glassware, Art. . . . .	1555
" Robes . . . . .	1507	" Wire . . . . .	1531	" Chemists' . . . . .	1555
" Trimmings . . . . .	1507	" Woven Wire . . . . .	1531	" Cut . . . . .	1555
Furs, Dressed . . . . .	1507	Gauges, Back Pressure . . . . .	1532	" Druggists' . . . . .	1555
Furnaces, Blast . . . . .	1502	" Combination . . . . .	1532	" Fancy Colored . . . . .	1555
" Boiler . . . . .	1505	" Cream . . . . .	1533	" Flint . . . . .	1555
" "Harris," Wood . . . . .	1503	" Indicating . . . . .	1532	" Pressed . . . . .	1555
" Heating . . . . .	1505	" Locomotive . . . . .	1532	" Table . . . . .	1555
" Hot Air . . . . .	1505	" Pressure . . . . .	1532	Globes, Electric Light . . . . .	1556
" Hot Air (Cumberland) . . . . .	1504	" Saw . . . . .	1535	" Fish . . . . .	1556
" Cast Iron . . . . .	1505	" Steam . . . . .	1532	" Lamp . . . . .	1556
" "Monarch," Coal . . . . .	1503	" Track . . . . .	1534	" Lantern . . . . .	1556
" Ore Smelting . . . . .	1502	" Vacuum . . . . .	1532	Gloves, Boxing . . . . .	77
" "Perfect," (Air Tight) . . . . .	1503	" Water . . . . .	1536	" Buckskin . . . . .	1558
" Revolving Roasting . . . . .	1502	" Water (Automatic) . . . . .	1536	" Calfskin . . . . .	1558
Furniture, Altar . . . . .	1508	Gauntlets, Fur . . . . .	1507	" Fur . . . . .	1559
" Bamboo Toy . . . . .	1511	Gears, Bevel . . . . .	1544	" Fur Top . . . . .	1558
" Bank . . . . .	1508	" Carriage . . . . .	1545	" (Kid) Fur Top . . . . .	1558
" Bedroom . . . . .	1506	" Cast . . . . .	1544	" Kid, Lined . . . . .	1558
" Church . . . . .	1508	" Cheese Factory Crane . . . . .	1542	" Kid, Unlined . . . . .	1558
" Court House . . . . .	1508	" Hoisting . . . . .	1544	" Knitted . . . . .	1914
" Dining Room . . . . .	1506	" Iron . . . . .	1544	" Leather . . . . .	1558
" Drawing Room . . . . .	1506	" Mortise . . . . .	1544	" Nappa Buck . . . . .	1558
" Hardwood . . . . .	1508	" Omnibus . . . . .	1543	" Rubber . . . . .	1557
" Hall . . . . .	1508	" Steering (Richardson's Improved) . . . . .	1541	" Sheepskin . . . . .	1558
" Household . . . . .	1506	" Truck . . . . .	1543	Glucose, Syrup . . . . .	3379
" Library . . . . .	1508	" Wagon . . . . .	1543	Glue, Carriage . . . . .	1562
" Lodge Room . . . . .	1508	" Worm . . . . .	1544	" Emery . . . . .	1562
" Office . . . . .	1508	Gearing, Agricultural Machinery . . . . .	1539	" Family . . . . .	1562
" Parlor . . . . .	1508	" Bevel . . . . .	1540	" Fish . . . . .	1560
" Public Building . . . . .	1503	" Friction . . . . .	1544	" Furniture . . . . .	1562
" Public School . . . . .	1508	" Machine Cut . . . . .	1538	" Liquid . . . . .	1561
" Society, Secret . . . . .	1508	" Mitre . . . . .	1544	" Piano Makers' . . . . .	1562
" Sunday-School . . . . .	1508	" Shrouded . . . . .	1544	" Tablet . . . . .	1562
" Theatre . . . . .	1508	" Spur . . . . .	1540	Glycerine . . . . .	1563
" Upholstered . . . . .	1506	Generators, Electric . . . . .	1546	" Nitro . . . . .	1564
Furring, Terra Cotta . . . . .	1512	" Soda Water . . . . .	1544a	Glycerole, Pepsin Comp . . . . .	1565
Fuse . . . . .	1513	" Telephone . . . . .	1547	" Yerba Comp . . . . .	1565
Fuse, Blasting . . . . .	1513	Gigs, Cloth . . . . .	1550	Godders, for Slate and Marble . . . . .	1566
" Electric . . . . .	1513	" Ice . . . . .	1548	Gold, Chloride . . . . .	799
" Platinum . . . . .	1513	" Ore . . . . .	1549	" Oxide . . . . .	1567
" Safety . . . . .	1513	Gimps, Furniture . . . . .	1551	Gongs, Electric . . . . .	1568
" Waterproof . . . . .	1513	Ginger Pop . . . . .	20	" Fire Alarm . . . . .	1569
Galleys, Printers (Brass) . . . . .	1515	Girders, Box . . . . .	1552	" Hotel . . . . .	1569
" Printers (Wood) . . . . .	1514	" Bridge . . . . .	1552	" Ship . . . . .	1569
Galvanometers . . . . .	1516	" Iron . . . . .	1552	" Street Car . . . . .	1569
Games, Parlor (Wood) . . . . .	1517	" Plate . . . . .	1552	Goose, Canned . . . . .	612
Garters, Plastic . . . . .	1518	" Steel . . . . .	1552	Governors, Engine (Evan's Pa- tent) . . . . .	1570
Gasfires, (Fireplace) Fire Clay . . . . .	1519	" Tee . . . . .	1552	" Gas . . . . .	1571
Gaskets, Asbestos . . . . .	1520	Girdles, Chenille Curtain . . . . .	1553	" Pump . . . . .	1572
" Copper . . . . .	1522	Girths, Leather . . . . .	1554	" Steam . . . . .	1572
" Lead . . . . .	1522	" Saddle . . . . .	1554	" Water Wheel . . . . .	1572
" Rubber (Fibrous) . . . . .	1521	Gladstone (Carriages) . . . . .	646	Granite, Red . . . . .	1573
Gasoline . . . . .	1523	Glass, Art . . . . .	1555	" Rough . . . . .	1573
Gates, Automatic . . . . .	1526				

INDEX TO ARTICLES.

	No.	Grinders,	No.	Hammers,	No.
Graniteware, White..	1574	" Pulp (for reduction of		" Law's Patent "Opti-	
Granules, Effervescing...	1575	Wood Pulp)... ..	1601	mates" .....	1637
(Milk) with Cereals..	1576	" Reamer.. ..	1594	" Log.. ..	1636
Grape Juice, Unfermented..	1880	" Saw.. ..	1598	" Machinists'.. ..	1644
Grass, (Sea) Upho'sterers'..	1577	" (Emery) Saw.. ..	1598	" Magnetic.. ..	1638
Grate Bar, (Rocking).. ..	138	" Shimer Head.. ..	1602	" Malleable.. ..	1639
Grates, Boiler.. ..	1580	" Shop.. ..	1595	" Masons'.. ..	1644
Fire Place.. ..	1579	" Emery Suspension..	1598	" Paving.. ..	1644
Furnace.. ..	1580	" (Emery) Tool.. ..	1598	" Piano.. ..	1640
Mantel.. ..	1579	" Universal Cutter..	1594	" Planishing.. ..	1643
Register, Floor.. ..	1579	Grindstones.. ..	1603	" Plastering.. ..	1643
Stove.. ..	1579	Grips, Elevator Hand..	1592	" Power.. ..	1642
Wall Register.. ..	1579	" Lock Stop.. ..	1592	" Prospecting.. ..	1644
Graters, Box.. ..	1578	Groovers, Double Seamer..	1605	" Raising.. ..	1643
Cocconut.. ..	1578	Hand.. ..	1605	" Riveting.. ..	1644
Horseradish.. ..	1578	Tinsmiths'.. ..	1605	" Saw.. ..	1641
Nutmeg.. ..	1578	Grommets, Iron Ring.. ..	1604	" Setting.. ..	1643
Vegetable.. ..	1578	Guards, Belt Hole.. ..	1609	" Slaters'.. ..	1644
Gratings, Area.. ..	1581	" Brass Window.. ..	1610	" Sledge.. ..	1644
Cast.. ..	1581	" Cattle.. ..	1608	" Steam.. ..	1642
Door.. ..	1581	" Cell Door.. ..	1609	" Stone.. ..	1644
Jail.. ..	1581	" Church Window.. ..	1612	" Tack.. ..	1634
Sidewalk.. ..	1581	" Counter, (Brass).. ..	1610	" Tinnners'.. ..	1644
Window.. ..	1581	" Door.. ..	1609	" Trip.. ..	1642
Wrought Iron.. ..	1581	" Elevator.. ..	1278	Hammer and Nail Puller com-	
Grease, Axle.. ..	1582	" Knife Head.. ..	1606	bined.. ..	2654
Bears'.. ..	1585	" Low's Patent.. ..	1608	Hammocks, Twine.. ..	1645
Belt.. ..	1582	" Piano.. ..	1611	Hampers, Wicker.. ..	1646
Pipe Joint.. ..	1583	" Railway.. ..	1608	Handles, Adze.. ..	1655
Soap.. ..	1584	" Reaper and Mower..	1606	" Auger.. ..	1654
Greases, Cog.. ..	1586	" Reaper & Mower Knife..	1606	" Awl.. ..	1654
Cut.. ..	1586	" Spark (Wire).. ..	1612	" Axe.. ..	1655
Dredge.. ..	1586	" Stove (Wire).. ..	1612	" Barn Door.. ..	1658
Dynamo.. ..	1586	" Skylight.. ..	1609	" Bicycle (Cork).. ..	1650
Graphite.. ..	1586	" Surface.. ..	1608	" Bicycle (Rubber)..	1652
Lubricating.. ..	1586	" Tree (Wire).. ..	1612	" Blacksmiths'.. ..	1655
Pitt Tub.. ..	1586	" Trouser (Bicyclists')..	1607	" Boiler.. ..	1653
Saw Mill.. ..	1586	" Window (Wire).. ..	1612	" Bronze Door.. ..	1658
Green Paris.. ..	1587	Gudgeons.. ..	1613	" Broom.. ..	1655
Griddles, Cake.. ..	1588	Guitars.. ..	1615	" Brush.. ..	1655
Grille Work, Bank and Office,		Guides, Saw.. ..	1614	" Cant Hook.. ..	1651
Brass.. ..	1591	Gum, Adhesive.. ..	1618	" Carriage Seat.. ..	1653
Grille Work, Bank and Office,		" Chewing (Pepsin).. ..	1620	" Carpet Sweeper..	1655
Iron.. ..	1589	" Dental.. ..	1617	" Carriage Door.. ..	1649
Grille Work, Bank and Office,		" Padding.. ..	1619	" Cheese Hoop.. ..	1653
Metal and Wire..	1589	" Pure Sheet.. ..	1616	" Chest.. ..	1658
Grille Work, Bank and Office,		Gummers, Saw.. ..	2913	" Chest (Surface)..	1658
Wood.. ..	1590	Saw, Emery Wheel..	2914	" Children's Carriage..	1659
Grinders, Centre.. ..	1597	Guns, Spun Metal.. ..	1621	" Chisel.. ..	1654
Combination.. ..	1597	Gunpowder.. ..	2601	" Cross Cut Saw.. ..	1687
Emery, Bench.. ..	1598	Gutters, Iron.. ..	1831	" Draw Shave.. ..	1654
Emery, Counter Shaft..	1598	" Stable.. ..	1831	" Door.. ..	1658
Emery, Huntingdon's		Hames, Iron.. ..	1633	" Drop.. ..	1658
Patent.. ..	1596	Hames, Wood.. ..	1632	" Farming Tool.. ..	1655
Emery, Lathe Center..	1598	Hammers, Air Cushion..	1642	" Feather Duster..	1655
Emery, Planer Knife..	1593	" Blacksmiths'.. ..	1644	" File.. ..	1655
Emery, Stove Plate..	1593	" Boiler Makers'.. ..	1644	" Fork.. ..	1655
Emery, Suspension..	1598	" Brad.. ..	1644	" Furniture.. ..	1658
Emery Wheel (Double		" Bricklayers'.. ..	1644	" Hammer.. ..	1655
and Single.. ..	1593	" Bush.. ..	1644	" Hatchet.. ..	1655
Feed.. ..	1600	" Carpenters'.. ..	1644	" Hickory.. ..	1655
Foot Power.. ..	1595	" Carriage Ironers'..	1644	" Hoe.. ..	1655
Grain.. ..	1600	" Cast Iron.. ..	1635	" Iron.. ..	1658
Grain, (Vessot's).. ..	1599	" Cast Steel.. ..	1644	" Ice Pick.. ..	1655
Hardie's Patent.. ..	1596	" Chipping.. ..	1644	" Leather.. ..	1656
Hand Power.. ..	1595	" Coopers'.. ..	1644	" Malleable.. ..	1658
Hollow-ware.. ..	1598	" Drop.. ..	1642	" Metal.. ..	1658
Kitchen.. ..	1595	" Eavetrough.. ..	1643	" Milk Can.. ..	1653
Knife.. ..	1597	" Engineers'.. ..	1644	" Mop.. ..	1655
Moulding Bit.. ..	1602	" Flanging.. ..	1643	" Net Landing.. ..	1661
				" Pail.. ..	1648

INDEX TO ARTICLES.

Handles,	No.	Hats,	No.	Hinges,	No.
" Parasol . . . . .	1657	" Silk . . . . .	1686	" Hook and Eye . . . . .	1721
" Peavy . . . . .	1651	" Society . . . . .	1684	" Lion . . . . .	1723
" Pick . . . . .	1655	" Straw . . . . .	1683	" Mirror . . . . .	1721
" Rake . . . . .	1655	" Uniform . . . . .	1684	" Piano Lid . . . . .	1720
" Sad Iron . . . . .	1658	" Yacht . . . . .	1684	" Blush Box . . . . .	1720
" Screw Driver . . . . .	1654	Hatches, Elevator, Safety . . . . .	1679	" Screw Hook . . . . .	1722
" Seat . . . . .	1653	Hatchets, Bench . . . . .	1680	" Shutter . . . . .	1721
" Shovel . . . . .	1655	" Chopping . . . . .	1680	" Special . . . . .	1722
" Sledge . . . . .	1655	" Claw . . . . .	1680	" Spring . . . . .	1721
" Socket Chisel . . . . .	1654	" Half . . . . .	1680	" Spring, Double Acting . . . . .	1720
Handles, Stove Door . . . . .	1658	" Lathing . . . . .	1680	" Strap, Heavy & Light . . . . .	1722
" Tea Pot . . . . .	1653	" Round Faced . . . . .	1680	" T. and Strap . . . . .	1721
" Torch . . . . .	1655	" Shingling . . . . .	1680	" Table . . . . .	1721
" Umbrella . . . . .	1657	" Warehouse . . . . .	1680	" Tail Board . . . . .	1722
Hangers, Barn Door . . . . .	1666	Haulages, Wire Rope . . . . .	1687	" Trunk . . . . .	1722
" Bell Cord . . . . .	1665	Hay, (see Merchants) . . . . .	3854	" and Hasps . . . . .	1721
" Drop . . . . .	1666	Hay, Chopped . . . . .	1689	Hives, Bee . . . . .	1724
" Door . . . . .	1666	Heads, Bill . . . . .	1700	Hods, Coal . . . . .	1726
" Eaves Trough . . . . .	1664	" Cross . . . . .	1699	" Coal (Brass) . . . . .	1725
" Elevator Door . . . . .	1664	" Drum (Calf Skin) . . . . .	1694	" Coal, Corrugated Steel & Iron . . . . .	1726
" Parting . . . . .	1667	" Exhaust Pipe . . . . .	1695	" Coal (Galvanized Iron) . . . . .	1726
" Patent . . . . .	1663	" Iron Post . . . . .	1698	" Coal (Iron) . . . . .	1726
" Picture . . . . .	1666	" Invoice . . . . .	1700	" Coal (Japanned) . . . . .	1726
" Pipe . . . . .	1662	" Lathe . . . . .	1696	Hoes, Corn . . . . .	1727
" Post . . . . .	1667	" Letter . . . . .	1700	" Eye . . . . .	1728
" Ring Oiler . . . . .	1667	" Mather . . . . .	1696	" Field and Garden . . . . .	1728
" Self-Oiling . . . . .	1667	" Piston . . . . .	1695	" Grub . . . . .	1728
" Sliding Door . . . . .	1666	" Post . . . . .	2581	" Hand . . . . .	1728
" Street Car Door . . . . .	1666	" Spinning Wheel . . . . .	1697	" Mortar . . . . .	1728
Hangings, Asbestos . . . . .	55	" and Cutters, Shimer . . . . .	1701	" Planters . . . . .	1728
Hardies, Blacksmiths' . . . . .	1668	Headers, Branch . . . . .	1690	" Riveted . . . . .	1728
Hardware Merchants . . . . .	3846	Heading, Barrel . . . . .	3255	" Scuffler . . . . .	1727
Harness, Carriage . . . . .	1669	" Cheese Box . . . . .	1692	" Shank and Socket . . . . .	1728
" Cart . . . . .	1669	" Nail Keg . . . . .	1691	" Wheel . . . . .	1727
" Coach . . . . .	1669	Headstones, Slate . . . . .	1702	Hogs, Dressed . . . . .	3859
" Double . . . . .	1669	Headware, Linen, Embroidered . . . . .	1703	Hoists, Clutch . . . . .	1729
" Express . . . . .	1669	Hearses . . . . .	1704	" Friction . . . . .	1729
" Plow . . . . .	1669	Hearths, Slate . . . . .	1705	" Horse Power . . . . .	1729
" Pony . . . . .	1669	Heaters, Car . . . . .	1709	" Horse Power Mining . . . . .	1729
" Road . . . . .	1669	" Comb. Hot Air and Hot Water . . . . .	1713	" Mining . . . . .	1729
" Single . . . . .	1669	" Comb. Steam & Warm Air . . . . .	1713	" Quarry . . . . .	1729
" Waggon . . . . .	1669	" Feed Water . . . . .	1714	" Single and Double Drum . . . . .	1729
Harps, Lamp . . . . .	1670	" Gas . . . . .	1707	" Steam . . . . .	1729
Harrows, (Iron) Diamond Frame . . . . .	1672	" Glue . . . . .	1708	" Travelling . . . . .	1729
" Reversible Disk . . . . .	1671	" Hot Water . . . . .	1713	Holder, Bobbin . . . . .	332
" Rotary Disk . . . . .	1676	" Hot Water, for Hot Air Furnaces . . . . .	1706	" Broom (Brass) . . . . .	1730
" Set Lever . . . . .	1674	" Sad Iron . . . . .	1711	" Brush (Brass) . . . . .	1730
" Spring Tooth . . . . .	1675	" Steam . . . . .	1713	" Chuck Drill . . . . .	1737
" Steel (Diamond) . . . . .	1673	" Steam, Portable . . . . .	1713	" Conductor Pipe . . . . .	1736
" Vibrating . . . . .	1676	" Wheat . . . . .	1710	" Globe and Shade . . . . .	1732
" and Seeders, com- bined . . . . .	1674	Heels, Boot and Shoe . . . . .	1715	" Lathe Die . . . . .	1737
Harvesters, Clover . . . . .	1678	Helmets, Spun Metal . . . . .	1716	" (Log) Drag Saw . . . . .	1735
" Pea . . . . .	1677	Hematic Hypophosphites . . . . .	1789	" Mop (Brass) . . . . .	1739
" Twine Binding . . . . .	1678	Herbs, Powdered . . . . .	1717	" Necktie . . . . .	1734
Haps and Staples . . . . .	1721	" Pressed . . . . .	1717	" Paper Bag . . . . .	1732
Hats, Band . . . . .	1684	Herring . . . . .	1416	" Pillow Sham . . . . .	1732
" Bicycle . . . . .	1684	Hessians . . . . .	1719	" Postage Stamp . . . . .	1732
" Cloth . . . . .	1686	Hides . . . . .	3857	" Reamer . . . . .	1737
" Club . . . . .	1684	Hinges, Bed Lounge . . . . .	1722	" Reamer (Chucking) . . . . .	1737
" Derby . . . . .	1686	" Blind, (Outside, Inside) . . . . .	1723	" Roll Paper . . . . .	1731
" Felt . . . . .	1686	" Brass . . . . .	1723	" Stable Broom . . . . .	1831
" Firemens' . . . . .	1684	" Bronze . . . . .	1723	" Tin . . . . .	1738
" Fur . . . . .	1507	" Butt . . . . .	1721	" Whisk Broom (Brass) . . . . .	1730
" Ladies' (Lace) . . . . .	1681	" Carriage Door . . . . .	1722	Hollow Ware, (Household) Cast Iron . . . . .	1739
" Military . . . . .	1684	" Door . . . . .	1721	" Kitchen . . . . .	1739
" Oiled . . . . .	1685	" Gate . . . . .	1721	" Plated . . . . .	3092
" Police . . . . .	1684	" Self-Closing . . . . .	1721	" Sterling . . . . .	3092
" Rubber . . . . .	1682			Homespuns . . . . .	1740
" Seal Skin . . . . .	1507				

INDEX TO ARTICLES.

	No.	Hose,	No.	Injectors,	No.
Hones, Sharpening	1741	" Air Brake	1769	" Boiler	1798
Hoods, Children's	1914	" Brewers'	1769	" Gresham	1796
Hoods, Horse	277	" Chemical	1769	" Steam	1797
Hooks, Awning	1747	" Cotton (Fire)	1769	" Syphon	1795
" Belt	1742	" Divers'	1769	Inks, Carmine	1800
" Bird Cage	1749	" Engine	1769	" Colored	1800
" Boat	1747	" Fire Engine	1769	" Colored, Printing	1800
" Bolt	1751	" Fire (Rubber)	1769	" Copying	1800
" Breeching	1751	" Garden	1769	" Indelible	1800
" Bush	2950	" Gas	1769	" Lithographic	1800
" Cant	1744	" Hydraulic	1769	" Marking	1799
" Ceiling (Screw)	1747	" Lawn	1769	" Printing	1800
" Chain	1748	" Leather	1768	" Typewriting	1799
" Chandelier	1747	" Linen Fire	1771	" Writing	1799
" Check	1751	" Locomotive	1769	Inkstands, Glass	3242
" Clothes Line	1747	" Oil	1769	" Iron	3241
" Coat and Hat	1747	" Rubber Hand	1770	Insoles, Electric	1801
" Coat and Hat (Wire)	1753	" Steam	1769	" Felt	1802
" Corn	2950	" Suction	1769	" Leather	1803
" Expansion Pipe	1746	" Suction (Smooth Bore)	1770	Inspirators	1804
" Flashing	1752	" Suction (Spiral Wire)	1770	Inspirators, Hancock	1805
" Floor Track Hanger	1745	" Test	1769	Instruments, Band (Duplex)	1809
" Grapple	1743	" Wire Round (Kinkproof)	1770	" Band "Imperial"	1809
" Grass	2950	Hosiery, Cashmere	1772	Instruments, Caustery	1808
" Hall	1747	" Cotton	1772	" Electrical	1810
" Hammock	1747	" Merino	1772	" Lung Testing	1810
" Harness	1755	" Silk	1774	" Medical	1811
" Hay Fork	1748	" Woolen	1773	" Orthopaedical	1807
" Joint and Clevis	1750	" Worsted	1773	" Surgical	1808
" Lamp	1747	Hotels	3861	" Surveyors' Meteor-	
" Pad	1752	Houses, Knock Down	1776	ological	1806
" Peavies	1744	" Portable (Sheet Metal)	1775	" Telegraph	1810
" Pipe	1746	Housings, Hame	1669	" Telephone	1810
" Pipe (Soil)	1746	" Horse Collar	1669	" Veterinary	3272
" Potato	2950	" Saddle	1669	Insulators, Glass	1813
" Pulley	1745	Hubs, Bicycle	1778	" Lava	1813
" Rein	1751	" Fire Department (Cast		" Mica	1813
" Saddlery	1751	Iron)	1780	" Porcelain	1812
" Screw	1749	" Waggon	1779	Interlining, Fiberine	1814
" Snap	1750	" Truck and Engine (Fire		Inturates	1815
" Stable	1755	Department)	1789	Inverts, Clay Pipe	1816
" Strap	1751	Hulls, Dredge	1781	Iodide of Ammonium	1817
" Sweat Pad	1742	" Steamboat	1781	" of Cadmium	1817
" Tool	1755	" Steel	1781	" of Calcium	1817
" Tug	1751	" Steel Vessel	1781	" of Magnesia	1817
" Wardrobe	1747	" (Wood) Vessel	1782	" of Mercury	1817
" Weeding	2950	Huller and Pearler, Corn	1784	Iodine	1818
" Whiffletree	1752	Hullers, Buckwheat	1784	Iodoform	1819
" Wire	1749	" Clover	1783	Iron, Bar	1820
" Wrought Iron Screw	1750	Hurdles, Wire	1785	" Carbonate	1827
Hooks and Eyes, Dress	1756	Hydrants, Fire	1787	" Car Wheel	1829
Hooks and Eyes, Gate	1757	" Water Works	1787	" Carriage Makers'	1820
Hooks and Eyes, Hardware	1797	" Water Works (Law's		" Chloride	799
Hooks and Staples	1758	Patent)	1786	" Chromate	1827
Hooks and Terrets	3451	" Yard	1787	" Corrugated	1826
Hoops, Barrel	1762	Hydrastine, Alkaloid	1788	" Corrugated "Galvanized	1826
" Cheese (Tin)	1759	Hydrastinine, Hydrochlorate	1788	" Galvanized	1821
" Cheese Box	1763	" Sulphate	1788	" Dialyzed Glycerated	1828
" Coopers' Truss	1760	Hydrastinine, Hydrodilorate	1788	" Horseshoe	1820
" Truss (Surgical)	1761	Hydrophosphites, Hematic	1789	" Malleable	1825
Hops	3842	Ice, Camphor (Vaseline)	1790	" Merchant	1820
Hoppers, Water Closet	1764	Importers	3860	" Muriate	1827
Horehound, Balsam of (Sharp's)	1765	Indexes, Book	1792	" Nitrate	1827
Horns, Tin	3486	Indicators, Elevator	1793	" Pig	1822
Horseradish	2724	" Engine Room	1793	" Pig (Charcoal)	1823
Horses, Hobby	1767	" Speed	1793	" Refined	1820
" Rocking	1767	" Speed, Steam Engine	1793	" Sesquech'oride	1827
Horseshoes, (see Shoes)	3057	Inhalants	1794	" Sheet	1824
Hose, Acid	1769	Inhaler, (Semple's)	1811		
" Air	1769	Injectors, Air	1797		



INDEX TO ARTICLES.

	No.		No.		No.
Iron,		Jewels,		Kindergarten, Books, Materials.	1900
“ Stable Fittings.	1831	Jewels, Regalia.	1867	Knit Goods (Fancy).	1914
“ Sulphate.	1827	“ Society.	1867	Knives, Bookbinders’.	1908
“ Sulphide.	1827	Jewelry, Artistic.	1866	“ Carving.	1909
“ Acetate, Liquor.	2017	“ Diamond.	1863	“ Chipper.	1908
“ Ware, Enamelled.	1830	“ Gold.	1866	“ Cultivator.	1913
“ “ Galvanized.	1830	“ Hair.	1866	“ Curd.	1903
“ Work, Architectural		“ Silver.	1866	“ Farm Implement.	1908
(Wrought).	1832	Joints, Concealed.	1870	“ Fish.	3092
“ “ Ornamental		“ Expansion.	1871	“ Fruit (Plated).	3092
(Wrought).	1832	“ Flexible Water Pipe		“ Hay Cutter.	1902
“ “ Plain.	1832	(Law’s Patent).	1868	“ Hay (Upright).	1902
Irons.		“ Gas Pipe.	1869	“ “Heath’s Patent”.	1902
“ Branding.	1834	“ Stump.	1870	“ Honey.	1905
“ Clapping.	1845	Jointers, Gang Saw (Automatic).	1874	“ Lawn Mower.	1908
“ Deck.	1838	“ Heading.	1875	“ Machine (Wood).	1901
“ Derrick.	1151	“ Planer.	1873	“ Matcher.	1901
“ Edge Setter.	2119	“ Plow.	1872	“ Mincing.	1907
“ Gear.	1836	“ Shingle.	1876	“ Mower.	1908
“ Gear (Herbrand).	1835	“ Stave.	1875	“ Paper Cutter.	1910
“ Gear (Tinking).	1836	Journals, Book-keeping.	384	“ Planer.	1901
“ Plane.	1839	Jugs, Stoneware.	1882	“ Plated Fruit.	3092
“ Revolving Clothes Dryer.	1841	Juice, Grape, Unfermented.	1880	“ Plated Table.	3092
“ Sad.	1842	“ Lime.	1878	“ Shingle.	1901
“ Sad, Cold Handle.	1842	“ Lime and Pepsin.	1879	“ Splitting (Leather).	1909
“ “ Gas Heating.	1842	Juices, Fruit.	1881	“ Straw Cutter.	1906
“ “ Laundry.	1842	Jumpers, Cotton and Wool.	1883	“ Sterling Silver.	3092
“ “ Mrs. Potts’.	1837	“ Baby.	1884	“ Table.	3092
“ “ Polishing.	1842	Kalsomine, Wall.	1885	“ Tenoning.	1908
“ “ Self-Heating.	1842	K. D. C.	1886	“ Tobacco.	1904
“ “ Tailors’.	1842	Keelers, Cedar.	1887	“ Veneer.	1901
“ Soldering.	1840	Kegs, Beer.	1889	Knobs, Base.	1915
“ Tailors’.	1833	“ Nail.	1890	“ Brass Bedstead.	1916
“ Toy.	1842	“ Pickle.	1889	“ Bronze Shutter.	1918
“ Tuyere.	1843	“ Powder.	1890	“ Carved Wood.	1915
“ Waffle.	1846	“ Tack.	1888	“ Carriage Door.	1918
“ Whiffletree.	1836	Kensingtons (Carriages).	646	“ Desk.	1915
Jacks,		Kettles, Acid (Copper).	1894	“ Door.	1917
“ Boot.	1853	“ Acid (Iron).	2593	“ Drawer.	1915
“ Glassing.	1848	“ Brass.	1893	“ Key.	1918
“ Horse Power.	1850	“ Brewers’ (Copper).	1894	“ Metal Stone.	1916
“ Lifting.	1850	“ Color.	1894	“ Picture.	1918
“ Log.	1847	“ Confectioners’ (Copper).	1894	“ Porcelain.	1918
“ Pegging.	2119	“ Copper.	1893	“ Shutter.	1918
“ Pebbling.	1848	“ Enamelled.	1893	“ Spun Metal.	1916
“ Railway.	1850	“ Farmers’.	2593	“ Stove Door.	1917
“ Ratchet.	1850	“ Fish.	1892	“ Stove Slide.	1917
“ Track.	1850	“ Iron.	1892	“ Walnut.	1915
“ Tumbling Rod.	1851	“ Jacket.	1894	“ Wood.	1915
“ Waggon.	1849	“ Lard.	1892	Knockers, Door.	1919
Jackets, Cardigan.	1854	“ Patent Dome Bottom.	1891	Kola Nut Preparations.	1920
“ Hose.	1856	“ Potash.	1892	Kolavin.	1920
“ Hunting.	1858	“ Range.	1893	Labels, Bottle.	2019
“ Life (Cork).	1857	“ Scalding.	2593	“ Brass.	1921
“ Poro-Plastic.	1855	“ Soap.	2593	“ Cigar Box.	2019
“ Wool.	1854	“ Stove (Iron).	2593	“ Drug.	2019
Jams, Fruit.	1859	“ Stove (Brass & Copper).	1893	Lace, Bed.	1922
Japans.	1860	“ Sugar.	1894	Laces, Corset.	1923
Jars, Confectioners’.	1863	“ Swing.	2593	Lacings, Belt.	1924
“ Fruit.	1862	“ Tanners’.	2593	“ Leather.	1924
“ Glass.	1863	“ Tea (Brass & Copper).	1893	“ Rawhide.	1924
“ Honey.	1863	“ Tea (Iron).	1892	Lacquers.	1925
“ Stoneware, Jam.	1862	“ Vacuum.	1894	Ladders, Bicycle Shelf.	1926
“ “ Fruit.	1862	“ Varnish (Copper).	1894	“ Bicycle Step.	1926
“ “ Pickle.	1862	Keys, Door.	1897	“ Extension.	1927
Jardinieres, Bamboo.	1861	“ Organ.	1896	“ Farm.	1927
Jaws, Plow.	2547	“ Spring.	1898	“ Fire.	1318
Jellies, Fruit.	1859	“ Telegraph.	1895	“ Folding.	1927
Jelly, Beef (Mosquera).	212	Kid, Calf.	1967	“ Painters’.	1927
“ Beef (Mosquera) Fluid.	212	Kidneywort.	1899		
“ Melrose (Skin Preparation).	1865				
Jellstone.	1864				
Jerseys.	1854				

INDEX TO ARTICLES.

	No.		No.		No.
Ladders,		Lath,		Leather,	
" Safety.. . . . .	1927	" Sheet Steel, Fireproof. . .	1943	" Enamelled. . . . .	1966
" Step. . . . .	1927	" Lathes, Amateur. . . . .	1946	" Fancy. . . . .	1972
Ladles, Butter. . . . .	1928	Lathes, Axe Handle. . . . .	1946	" Glazed. . . . .	1964
" Foundry. . . . .	1929	" Axle. . . . .	1948	" Glove. . . . .	1967
" Plumbers'. . . . .	1929	" Beading. . . . .	1946	" Goat. . . . .	1967
Lager Beer, " Bavarian " . . .	213	" Bench. . . . .	1948	" Grain. . . . .	1973
Lager Beer, " Export " . . . .	213	" Bobbin. . . . .	1946	" Harness. . . . .	1973
Lamps, Alternating. . . . .	1930	" Bolt. . . . .	1948	" Imitation. . . . .	1964
" Arc. . . . .	1930	" Brass Finishers'. . . . .	1948	" Kangaroo. . . . .	1964
" Bicycle. . . . .	1935	" Break. . . . .	1945	" Kid. . . . .	1967
" Binnacle. . . . .	1934	" Burnishing. . . . .	1949	" Lacc. . . . .	1961
" Brass. . . . .	1933	" Car Wheel. . . . .	1945	" Moccasin. . . . .	1963
" Brazing. . . . .	1931	" Chair Makers'. . . . .	1947	" Moccasin (Beef). . . . .	1963
" Caboose and Tail. . . . .	1934	" Chucking. . . . .	1948	" Morocco. . . . .	1967
" Car. . . . .	1934	" Crank Pin. . . . .	1948	" Oil Dressed Indian Tan. . . .	1962
" Carriage. . . . .	1934	" Cutting-off. . . . .	1948	" Organ and Piano. . . . .	1966
" Cut Glass. . . . .	1932	" Drill. . . . .	1948	" Patent. . . . .	1971
" Dash. . . . .	1834	" Driving Wheel. . . . .	1945	" Pebbled. . . . .	1972
" Electric. . . . .	1930	" Engine. . . . .	1948	" Picker. . . . .	1961
" Fishing. . . . .	1936	" Foot Power. . . . .	1949	" Pocketbook. . . . .	1970
" Glass. . . . .	1932	" Gap. . . . .	1948	" Porpoise. . . . .	1965
" Hand, Glass. . . . .	1932	" Gauge. . . . .	1946	" Russet. . . . .	1973
" Hand (Tin). . . . .	1934	" Grinding. . . . .	1948	" Saddlery. . . . .	1973
" Hanging. . . . .	1933	" Hand Power. . . . .	1949	" Shaft. . . . .	1968
" Headlight. . . . .	1934	" Handle Turning. . . . .	1946	" Sheepskin. . . . .	1967
" Incandescent. . . . .	1930	" Hub. . . . .	1946	" Shoe. . . . .	1973
" Library. . . . .	1933	" Last. . . . .	1946	" Sole. . . . .	1969
" Locomotive Cab. . . . .	1934	" Monitor. . . . .	1948	" Split. . . . .	1972
" Mast Head. . . . .	1934	" Neck Yoke. . . . .	1946	" Standard Oak Lace. . . . .	1974
" Metal Figure. . . . .	1933	" Pattern Makers'. . . . .	1947	" Trimming. . . . .	1972
" Metal Stand. . . . .	1933	" Precision Bench. . . . .	1949	" Upholstery. . . . .	1972
" Miners'. . . . .	1934	" Precision Engine. . . . .	1949	" Upper. . . . .	1973
" Newel Post. . . . .	1933	" Polishing. . . . .	1944	Lecturns, Brass. . . . .	1975
" Piano. . . . .	1933	" Pulley Boring & Turning. . . .	1948	Legs, Artificial. . . . .	1994
" Pulpit. . . . .	1933	" Roll Turning. . . . .	1948	" Piano Stool. . . . .	1978
" Railroad. . . . .	1934	" Screw Cutting. . . . .	1948	Leggins, Hunting. . . . .	1977
" Regenerative Gas. . . . .	1936	" Speed. . . . .	1945	" Leather. . . . .	1977
" Side. . . . .	1934	" Tire. . . . .	1945	" Rubber. . . . .	1976
" Silver Plated. . . . .	3092	" Turret. . . . .	1948	Lemonade. . . . .	20
" Street. . . . .	1933	" Variety. . . . .	1946	Lenses, Telescope. . . . .	1979
" Street Car. . . . .	1934	" Wood Turning. . . . .	1946	Letters, Brass. . . . .	1981
" Table. . . . .	1933	Launches, Steam. . . . .	1950	" Copper. . . . .	1981
" Tubular Station. . . . .	1934	Lead, Bar. . . . .	1954	" Enamelled White. . . . .	1980
Landaus (Carriages). . . . .	646	" Black. . . . .	1956	" Pattern (Brass). . . . .	
Lanterns, Brass. . . . .	1938	" Chloride. . . . .	1952	" Sign (Brilliant). . . . .	1980
" Bull's Eye. . . . .	1937	" Nitrate. . . . .	1952	" Steel. . . . .	1981
" Conductors'. . . . .	1938	" Pig. . . . .	1954	" Wooden. . . . .	1982
" Firemens'. . . . .	1938	" Red. . . . .	1955	Levels, Surveyors' (Dump & Y). . .	1983
" Hanging Hall. . . . .	1933	" Sash. . . . .	1954	Lever, Cistern. . . . .	1984
" Railway. . . . .	1938	" Sheet. . . . .	1953	Licorice Goods. . . . .	952
" Ship. . . . .	1934	" Sulphate. . . . .	1952	Lids, Journal, Box. . . . .	1985
" Tubular. . . . .	1934	" White (in Oil). . . . .	1951	Lifts, Sash. . . . .	1987
" Yacht. . . . .	1934	" White. . . . .	1955	Lifters, Plate (Wire). . . . .	1986
Lappers, Hoop. . . . .	1939	Leaders, Cattle. . . . .	1959	" Stove Lid. . . . .	1986
Lard, Pure. . . . .	2576	Leads, Piano. . . . .	1958	Lights, Carriage Curtain. . . . .	1991
Larigans, Oil Tanned. . . . .	1940	" Printers. . . . .	1957	" Deck. . . . .	1990
Lashes, Whip. . . . .	3768	Leaf, Gold. . . . .	1960	" Head (Electric Car). . . . .	1993
" Whip (Cotton). . . . .	3768	Leather, Bag. . . . .	1970	" Head (Locomotive). . . . .	1993
Lasts (Wood) Boot and Shoe. . .	1941	" Bellows. . . . .	1968	" Search (Electric). . . . .	1992
Latches, Cupboard. . . . .	2028	" Belting. . . . .	1961	" Ship. . . . .	1990
" Door. . . . .	2028	" Book Binders'. . . . .	1970	" Side. . . . .	1990
" Gate. . . . .	2028	" Buckskin. . . . .	1967	Lighters, Cigar. . . . .	1988
" Knob. . . . .	2028	" Calf. . . . .	1967	" Jet. . . . .	1989
" Refrigerator. . . . .	2023	" Calf (Russian). . . . .	1965	" Lighters and Extinguishers, Candle. . . .	1989
" Sliding Door. . . . .	1942	" Carriage. . . . .	1968	Limbs, Artificial. . . . .	1994
" Spring. . . . .	2028	" Chamois (Imitation). . . . .	1964	Lime, Acetate of. . . . .	1
Lath, Expanded Metal. . . . .	1943	" Dash. . . . .	1968	" Gray. . . . .	1995
" Galvanized Iron. . . . .	1943	" Dongola. . . . .	1970	" Plastering. . . . .	1995
" Iron. . . . .	1943	" Embossed and Illuminated. . . . .	1966		
" Metallic, " Hay's Patent " . .	1943				
" Perforated Metal. . . . .	1943				

INDEX TO ARTICLES.

	No.		No.		No.
Lime,		Locks,		Lye, Concentrated...	2040
" White...	1995	" Sewing Machine...	2028	Macaroni...	3660
Limits, Timber...	3481	" Sliding Door...	2023	Machines, Automatic (Iron	
Lines, Awning...	1998	" Spring...	2028	Working)...	2101
" Chalk (Braided)...	1998	" Trunk...	2028	" Band Saw (Double)...	2093
" Clothes ("Spiral" Wire)...	1996	" Tumbler...	2028	" Barking (Wood)...	2111
" Clothes (Wire)...	1997	Locketts, Gold...	2022	" Barrel Heading...	2083
" Clothes (Cotton)...	1998	Locomotive Axles...	74	" Barrel Trusser...	2067
" Deep Sea Fish...	1998	" Boilers...	342	" Beating Out...	2119
" Garden...	1998	" Castings...	715	" Blind Slat...	2102
" Plow...	1998	" Clocks...	856	" Blind Wiring...	2072
" Trowling...	1998	" Cylinders...	1137	" Bending (Timbers)...	2125
Liniment, Alpine (Sharpe's)...	1999	" Forgings...	1456	" Bending (Metal	
" Household...	2001	" Parts...	2029	Working)...	2129
" Simpson's"...	2000	" Pistons...	2500	" Bolt Threading...	2130
Linings, Carpet...	2010	" Pumps...	2677	" Boring (Bench)...	2098
" Carpet (Wadded)...	2011	Locomotives, Heavy...	2029	"    " (Car Wheel)...	2112
" Casket...	2002	"    " Light...	2029	"    " (Horizontal)...	2112
" Cotton (Printed)...	2003	"    " Logging...	2029	"    " (Metal)...	2136
" Floor...	2010	"    " Mine...	2029	"    " (Metal Gauge)...	2136
" Fireplace...	2005	Looms, Carpet...	2030	"    " (Metal Port-	
" Flue...	2009	" Cotton Mill...	2030	able)...	2112
" Folded Paper (Patent)...	2007	" Woolen Mill...	2030	"    " (Mill)...	2101
" Grate...	2005	Loops, Body...	2032	"    " (Post)...	2102
" Heating Apparatus...	2005	" Box (Leather)...	2034	"    " (Vertical)...	2112
" Mattress...	2004	" Buckle (Leather)...	2035	"    " (Turning and	
" Skirt (Hair Cloth)...	2008	" Carriage...	2032	Slotting Combined)...	2133
" Stove...	2005	" Hame...	2033	" Bottle Capping...	2064
" Stove (Asbestos)...	2006	" Ladies' Jacket...	2031	" Bottling (Beer)...	2084
Links, Chain (Jewelers')...	757	Lounges...	1506	" Bottling, Corking &	
Lintels, Iron...	2013	Lounges, Bed...	1506	Filling...	2084
" Stone...	2012	" Upholstered...	1506	" Brick...	2132
Liquids, Normal...	2014	Lozenges...	952	" Broom Handle...	2062
Liquor, Iron...	2017	Lozenges (Compressed)...	2036	" Burring...	2125
" Iron (Black)...	2016	" (Medicated)...	2036	" Buttoning...	2110
" Red...	2015	Lubricators, Adjustable...	2039	" Button Making	
" Sedans...	2018	" Centrifugal...	2039	(Shotts')...	2070
Lithographing, Bottle...	2019	" Car Axle...	2037	" Cancelling (Stamp)...	2068
" Color...	2019	" Cylinder...	2039	" Card Grinding...	2104
" Commercial...	2019	" Cylinder Sight		" Casting (Type Line)...	2080
" Cigar Box...	2019	Feed...	2039	" Centering (Iron Work-	
" Drug...	2019	Dynamo...	2039	ing)...	2101
" Photo...	2019	" Self-Piston (Pat.)...	2038	" Chancelling (Slate &	
Loaders, "Elevator"...	2020	" Self-Valve Reed		Marble)...	2099
" Grain Car...	2020	" Sight Feed...	2038	" Channelling (Boot &	
" Hay...	2021	Lumber, Antiseptic...	2046	Shoe)...	2119
Locks, Burglar Proof, Safe...	2025	" Ash...	2042	" Cheese Box...	2109
" Burglar Proof, Sash...	2025	" Balm of Gilead...	2045	" Cheese Box Nailing &	
" Cabinet...	2028	" Basswood...	2042	Bending...	2086
" Carriage...	2028	" Beech...	2043	" Circular Saw...	2074
" Chest...	2028	" Birch...	2043	" Circular Saw (Port-	
" Cupboard...	2028	" Butternut...	2048	able)...	2074
" Dead...	2028	" Buttonwood...	2048	" Circular Re-Sawing...	2074
" Desk...	2028	" Cedar...	2043	" Clapboard...	2110
" Door...	2028	" Cottonwood...	2048	" Clapboard Sawing...	2117
" Drawer...	2028	" Douglas Fir...	2047	" Clay Tempering...	2121
" Hasp...	2026	" Dressed...	2041	" Cloth Brushing...	2113
" Keyless...	2028	" Elm...	2042	"    " Finishing...	2113
" Knob...	2028	" Hardwood...	2042	"    " Folding...	2113
" Latch...	2023	" Hemlock...	2042	"    " Inspecting...	2113
" Lever...	2023	" Hickory...	2048	"    " Measuring...	2113
" Mortise...	2028	" Maple...	2043	"    " Rolling...	2113
" Oar...	2027	" Oak...	2044	"    " Shearing...	2113
" Padlock...	2028	" Poplar...	2048	"    " Soaping...	2065
" Patent...	2024	" Pine...	2049	"    " Trimming...	2113
" Post Office...	2028	" Sanitas Wood...	2046	"    " Washing...	2077
" Refrigerator...	2023	" Spruce...	2050	"    " Windng...	2113
" Row...	2027	" Sycamore...	2048	" Composing...	2085
" Safe...	2027	" Tamarack...	2048	" Capping...	2125
" Safety Door & Transom...	2024	" Walnut...	2048		
" Sash...	2023	" Whitewood...	2048		

INDEX TO ARTICLES.

Machines,	No.	Machines,	No.	Machines,	No.
" Capping and Beading (" De Cew & Carpenter's " Power) . . . . .	2125	" Knitting (Ladies' Jersey) . . . . .	2081	" Sash, Door and Blind . . . . .	2102
" Cord Wood Sawing . . . . .	2124	" Knitting (Ribbed) . . . . .	2081	" Saw (Cross Cut) . . . . .	2075
" Cork Driving . . . . .	2064	" Knitting (Underwear) . . . . .	2081	" Saw (Drag) . . . . .	2124
" Cornice . . . . .	2125	" Leather Glazing . . . . .	2127	" Saw Filling and Gumming . . . . .	2071
" Corrugating . . . . .	2125	" Leather Measuring . . . . .	2127	" Saw (Rip) . . . . .	2074
" Cross Cut Saw . . . . .	2075	" Leather Polishing . . . . .	2127	" Saw (Self-Feeding) . . . . .	2074
" Crimping (Tinners) . . . . .	2125	" Leather Scouring . . . . .	2119	" Saw (Swing) . . . . .	2074
" Cutting off (Iron Working) . . . . .	2101	" Leather Splitting . . . . .	2127	" Saw Scarfing . . . . .	2096
" Cylinder (Iron Working) . . . . .	2101	" Linotype . . . . .	2080	" Saw Setting (Patent Cardinal) . . . . .	2118
" Cylinder (Stone) . . . . .	2083	" Manoline . . . . .	2080	" Saw Sharpening . . . . .	2071
" Ditching . . . . .	2066	" Measuring (Leather) . . . . .	2127	" Sawing (Clapboard) . . . . .	2117
" Dowel, Pin and Rod . . . . .	2134	" Metal Folding . . . . .	2107	" Sawing (Cord Wood, Portable) . . . . .	2124
" Drag Saw . . . . .	2124	" Metal Straightening . . . . .	2097	" Sawing (Scroll) . . . . .	2095
" Drilling . . . . .	2131	" Milk Testing (Babcock) . . . . .	2100	" Sawing (Shingle) . . . . .	2075
" Dry Press Brick . . . . .	2121	" Mining (Gold) . . . . .	2135	" Schott's Button Making . . . . .	2070
" Edge Setting (Boot and Shoe) . . . . .	2119	" Mitering (Foot and Hand) . . . . .	2102	" Scouring (Heel) . . . . .	2119
" Edging Saw . . . . .	2123	" Mortising (Hub) . . . . .	2072	" Scouring (Leather) . . . . .	2119
" Electric Dynamo . . . . .	2108	" Mortising (Wood) . . . . .	2072	" Scouring (Tanners) . . . . .	2062
" Emery Grinding . . . . .	3749	" Moss & Hair Picking . . . . .	2055	" Scouring (Wool) . . . . .	2121
" Emery Surface . . . . .	2101	" Moulding (Revolving Bed) . . . . .	2137	" Screw Polishing . . . . .	2091
" Eyelet . . . . .	2057	" Moulding (Shoe) . . . . .	2119	" Screw Slotting . . . . .	2138
" Facing (Nut) . . . . .	2101	" Moulding (Spiral) . . . . .	2120	" Scroll Sawing . . . . .	2095
" Flanging (Tinners) . . . . .	2125	" Moulding (Variety) . . . . .	2120	" Seam Rubbing . . . . .	2119
" Folding (Metal) . . . . .	2107	" Moulding and Matching (Combined) . . . . .	2137	" Seaming (Tinners) . . . . .	2125
" Folding (Sawing) . . . . .	2105	" Napping . . . . .	2103	" Self-Feeding Saw . . . . .	2074
" Folding (Stay, Boot and Shoe) . . . . .	2119	" Notching . . . . .	2125	" Setting Down . . . . .	2125
" Folding (Vamp) . . . . .	2119	" Nut Facing . . . . .	2101	" Sewing (Lock Stitch) . . . . .	2094
" Forming (Tinners) . . . . .	2125	" Nut Threading . . . . .	2130	" Sewing (Wire, Boot and Shoe) . . . . .	2119
" Gold Mining . . . . .	2135	" Pegging . . . . .	2057	" Shaft Straightening . . . . .	2097
" Grinding (Card) . . . . .	2104	" Picket (Wood) . . . . .	2056	" Shaping (Iron Top) . . . . .	2096
" Grinding (Emery) . . . . .	3749	" Pipe Threading . . . . .	2130	" Shaping (Journal Box) . . . . .	2097
" Grinding (Metal Working) . . . . .	2101	" Planing (Stone, Portable) . . . . .	2058	" Shaping (Wood Top) . . . . .	2096
" Grinding (Pulp) . . . . .	2083	" Polishing (Emery Wheel) . . . . .	2092	" Sheet Metal (Tinners) . . . . .	2125
" Grooving (Roll) . . . . .	2101	" Polishing (Horizontal) . . . . .	2092	" Shingle (Horse Power) . . . . .	2116
" Gutter . . . . .	2125	" Polishing (Leather) . . . . .	2127	" Shingle Sawing . . . . .	2075
" Heading (Barrel) . . . . .	2083	" Polishing (Screw) . . . . .	2091	" Shoe Lasting . . . . .	2119
" Heading (Cheese Box) . . . . .	2086	" Polishing (Upright) . . . . .	2092	" Shoe Shank . . . . .	2119
" Heel Scouring . . . . .	2119	" Polishing (Wood) . . . . .	2134	" Slotting (Iron Working) . . . . .	2097
" Heeling . . . . .	2057	" Power Punch . . . . .	2057	" Slotting (Screw) . . . . .	2138
" Hoisting (Friction) . . . . .	2078	" Pressing (Tailors) . . . . .	2059	" Slugging (Wire Grip) . . . . .	2119
" Hoisting (Steam) . . . . .	2078	" Pulp Grinding . . . . .	2083	" Soldering . . . . .	2125
" Hoisting & Handling (Coal) . . . . .	2078	" Pulp Wood . . . . .	2087	" Soling . . . . .	2119
" Hoisting & Handling (Double Drum) . . . . .	2078	" Punching (Toe Cap) . . . . .	2119	" Splitting (Leather) . . . . .	2127
" Hoisting & Handling (Earth) . . . . .	2090	" Punching and Shearing (Combined) . . . . .	2053	" Stave Crozing . . . . .	2083
" Hoisting & Handling (Ore) . . . . .	2078	" Rail Punching . . . . .	2053	" Stay Folding (Boot and Shoe) . . . . .	2119
" Hoisting & Handling (Single Drum) . . . . .	2078	" Range Makers . . . . .	2125	" Stone Planing (Portable) . . . . .	2058
" Hoisting & Handling (Speed) . . . . .	2078	" Rip Saw . . . . .	2074	" Straightening (Metal) . . . . .	2097
" Hoisting & Handling (Stone) . . . . .	2078	" Rivet . . . . .	2079	" Straightening (Shaft) . . . . .	2097
" Ironing (Collar and Cuff) . . . . .	2082	" Rivet (Tubular) . . . . .	2079	" Stripping (Boot and Shoe) . . . . .	2119
" Key Seating . . . . .	2097	" Riveting (Steam) . . . . .	2101	" Stud Setting . . . . .	2114
" Knitting (Cardigan Jacket) . . . . .	2081	" Rod, Pin and Dowel . . . . .	2134	" Swaging . . . . .	2125
" Knitting (Domestic) . . . . .	2081	" Roll Grooving . . . . .	2101	" Swing Saw . . . . .	2074
		" Rolling (Boot & Shoe) . . . . .	2119	" Tanners' . . . . .	2062
		" Rolling & Upsetting . . . . .	2053	" Tapping . . . . .	2101
		" Roofing (Tin) . . . . .	2125	" Tapping (Nut) . . . . .	2061
		" Rossing (Pulp Wood) . . . . .	2087	" Tempering (Clay) . . . . .	2121
		" Rossing (Tinners) . . . . .	2125	" Tenoning, Tonguing and Grooving . . . . .	2126
		" Sand Papering . . . . .	2095	" Testing (Milk " Babcock ") . . . . .	2100
		" Sand Papering (Boot and Shoe) . . . . .	2119	" Threading (Bolt) . . . . .	2130



INDEX TO ARTICLES.

	No.		No.		No.
Machines,		Mantels, Marble	2235	Meal, Beef (Mosquera)	1346
“ Threading (Nut)	2130	“ Over (Wood)	2153	“ Corn	2179
“ Threading (Pipe)	2130	“ Radiator	2152	“ Linseed	2180
“ Threshing (Grain)	2077	“ Slate	2151	“ Oat	2178
“ Threshing (Overshot)	2060	“ Terra Cotta	2150	“ Oil Cake	2180
“ Threshing (Under-shot)	2060	Mantles, Rubber	2160	Measures, Brass, Yard	2182
“ Timber Gaining	2072	Maps, School and Wall	2154	“ Copper, Liquid	2181
“ Timmers	2125	Marble, Blue	2155	“ Counter	2182
Machines, Toe Capping	2119	“ Flesh Color	2155	“ Tin, Liquid	2181
“ Treeing (Boot & Shoe)	2119	“ White	2155	“ Wooden	2183
“ Trimming (Heel)	2119	Marmalades	2156	“ Wooden, Dry	2183
“ Trimming (Welt)	2119	Mashers, Potato (Wood)	2157	Meat, Mince	2184
“ Trusser (Barrel)	2067	“ Vegetable and Potato		“ Mince, Condensed	2185
“ Turning and Burring	2125	(Wire)	2158	Medals, Agriculture Fair	2186
“ Typesetting	2085	Masts, Canoe	2159	“ Exhibition	2186
“ Typograph	2063	Mats, Bath (Rubber)	2163	“ Prize	2186
“ Vamp Folding	2119	“ Cocoa	2171	“ School	2186
Machines, Washing (Clothes)	2066	“ Coin (Rubber)	2163	“ Society	2186
“ Wire Clinching (Boot		“ Door, Lettered	2171	“ University	2186
and Shoe)	2119	“ Door (Wire)	2168	Medicines, Non-Secret	2187
Machines, Wire Fence, Hand	2089	“ Iron	2168	Meltons	867
“ Wire Grip Slugging	2119	“ Lambskin	2167	Memos, Artistic	2188
“ Wire Sewing (Boot &		“ Cuspadore	2163	Merchants, Flour & Feed, New	
Shoe)	2119	“ Oil Cloth	2165	Brunswick, Nova	
“ Wiring	2125	“ Picture	2169	Scotia, P.E.I., Que-	
“ Wiring (Blind)	2072	“ Rubber	2163	bec	3847
“ Wood Barking	2111	“ Rubber, Perforated	2164	“ App'le	3845
“ Wood Boring		“ Sheepskin	2167	“ Hardware	3846
(Cylinder)	2128	“ Wool, Bordered	2171	“ Barley	3850
“ Wood Boring (Hand)	2069	Matcher, Planer and Moulder,		“ Bean	3852
“ Wood Boring (Port-		Combined	2509	“ Buckwheat	3851
able)	2069	Matchers, Box Board	2161	“ Corn	3853
“ Wood Polishing	2134	“ Flooring	2161	“ Fresh Eggs	3849
“ Wood Splitting	2088	“ Rotary	2161	“ Pres. Eggs	3848
“ Wood Scouring	2121	“ and Planers	2509	“ Hay	3854
“ Wool Washing	2121	Matches, Parlor	2162	“ Skin and Hide	3857
“ Wrinkling	2119	“ Sulphur	2162	“ Hog, Dressed	3859
“ Yarn Doubling	2065	Matting, Cocoa	2171	“ Oat	3850
Mackintoshes	2139	“ Hemp	2171	“ Rye	3851
Magnesium Iodide	1817	“ Jute	2171	“ Seed	3856
Mallets, Calking	2140	“ Napier	2171	“ Tallow	3858
“ Carpenters'	2140	“ Rubber	2170	“ Wheat	3850
“ Ice	2140	“ Rubber (Corrugated)	2176	“ Pea	3855
“ Printers'	2140	“ Rubber (Embossed)	2170	Mercury	1817
“ Stone Cutters'	2140	“ Rubber (Smooth)	2170	Mercury, Distilled	1817
“ Timmers'	2140	Mattocks, Edge	2172	Metal, Babbitt	2193
Malt, Barley	2141	“ Pick	2172	“ Crimped Sheet	2189
Malt Extract, Ferrated	1346	Mattresses, Cotton	2176	“ Electrotyp	2192
“ with Beef Peptone	1346	“ Excelsior	2176	“ White	2190
“ with Cascara Sa-		“ Fibre	2176	“ Work, Structural	2195
grada	1346	“ Hair	2176	Metals, Journal Lining	2191
“ with Cod Liver		“ Mixed	2176	“ Perforated	2194
Oil	1346	“ Moss	2176	“ Stereotype	2192
“ with Hypophos-		“ Sea Grass	2176	Meters, Alternating Current	2197
phites	1346	“ Spiral Spring	2174	“ Ampere	2197
“ with Iron, Qui-		“ Spring	2176	“ Electric	2197
nine & Strychnine	1346	“ Upholstered	2176	“ Experimental Gas	2196
“ with Pepsin and		“ Wire	2173	“ Gas	2196
Pancreatin	1346	“ Woven Wire	2173	“ Registering	2197
“ with Yerba Santa	1346	“ Woven Wire		“ Station Gas	2196
Maltale	2142	(Cuban)	2175	“ Volt	2197
Mandolines	2143	“ Woven Wire (Oval)	2175	Milk, Condensed	891
Mandrels, Circular Saw	2144	“ Wool	2176	Mill Board, Asbestos	55
“ Expanding	2145	Mauls, Cast Steel	2177	Mills, Bark	2208
“ Taper	2145	“ Coal	2177	“ Bone	2206
Mangers, Iron	2146	“ Iron	2177	“ Buckwheat Roller	2202
Mangers and Hay Racks Com-		“ Railroad	2177	“ Cider	2203
bined	2146	“ Ship	2177	“ Cider and Press (Com-	
Mangles, Clothes (Laundry)	2147	“ Spike	2177	bined)	2203
Manholes, Concrete Stone	2149	“ Steel Face	2177	“ (Clover) Thresher	2204
“ Sewer	2148	“ Wood Choppers'	2177		

INDEX TO ARTICLES.

Mills,	No.	Moccasins,	No.	Muzzles, Dog (Wire)..	No.
" Cob..	2202	" Elk..	2225	" Horse..	2270
" Coffee..	2205	" Fancy..	2226	" Ox..	2270
" Corn..	2202	" Infants'..	2226	Nails, Barbed..	2272
" Corn Meal..	2202	" Indian..	2226	" Barrel (Wire)..	2278
" Corn Roller..	2202	" Eiderdown..	2226	" Basket (Cut)..	2271
" Corn and Cob..	2202	" Leather..	2225	" Basket (Wire)..	2278
" Curd..	2211	" Moose..	2225	" Boat (Cut)..	2271
" Drug and Spice..	2207	Models, Drawing..	2227	" Boat (Wire)..	2278
" Fanning..	2213	" Machinery (Wood)..	2229	" Box..	2278
" Fanning (Bag Attach- ment)...	2198	" Manufactured..	2228	" Builders' (Cut)..	2271
" Feed Roller..	2202	Moisteners, Envelope..	2230	" Builders' (Wire)..	2278
" Fulling..	2214	Molasses, Beet..	2231	" Car..	2278
" Grinding..	2202	Moleskin, Enamelled..	2232	" Cigar Box (Cut)..	2271
" Grist..	2202	Monograms, Harness..	2233	" Cigar Box (Wire)..	2278
" Hominy..	2202	Monuments, Bronze..	2234	" Clinch..	2276
" Lath..	2216	" Marble..	2235	" Clout..	2276
" Paint..	2205	" Granite..	2235	" Cut..	2271
" Pearl Barley..	2202	" Polished Marble..	2235	" Fence (Wire)..	2278
" Portable (Bone)..	2206	Mops, Floor..	2236	" Finishing (Brass)..	2277
" Portable Saw..	2215	Mortisers, Foot Power..	2072	" Finishing (Copper)..	2277
" Quartz..	2212	" Sash, Door & Blind..	2102	" Finishing (Cut)..	2271
" Roller..	2202	Motors, Air..	2239	" Flooring..	2278
" Rolling..	2199	" Alternating..	2237	" Galvanized..	2271
" Rotary Saw..	2215	" Battery..	2238	" Heel..	2273
" Saw (Band)..	2200	" Electric..	2238	" Hungarian..	2271
" Saw (Circular)..	2200	" Electric Power..	2237	" Iron..	2271
" Saw (Drag)..	2215	" Fan..	2238	" Lath..	2278
" Saw (Gang)..	2200	" Factory..	2238	" Lining..	2277
" Spice..	2207	" Printing House..	2238	" Lining (Wire)..	2278
" Ore Stamp..	2212	" Sewing Machine..	2238	" Picture..	2275
" Under Runner..	2202	" Street Railway..	2237	" Roofing..	2271
" Upper Runner..	2202	Moulders, Combined, Endless Bed..	2240	" Saddle..	2277
" Wind..	2201	Moulds, Brick..	2252	" Shank..	2271
" Wind, Gearless..	2210	" Button, "Schotts" ..	2248	" Sharp Pressed..	2271
" (Wind) Steel, Power..	2210	" Cylinder..	2245	" Shingle..	2271
" Wind, Steel (Pumping)..	2210	" Cake (Iron)..	2254	" Shoe..	2278
" (Wind) Sectional..	2210	" Glass..	2250	" Shook (Cut)..	2271
" and Bolters (Cimbinatiin)..	2216	" Ingot..	2255	" Shook (Wire)..	2278
" (Wind) "Mallorytown" ..	2205	" Plasterers..	2247	" Sidewalk..	2278
Millstones, Burr..	2217	" Soap..	2246	" Slating..	2271
Mince Meat..	2184	" Solder..	2251	" Steel..	2271
Mirrors, Beveled..	2219	Mouldings, Brass..	2244	" Tinned..	2275
" Cheval..	2219	" Bronze..	2244	" Trunk..	2277
" Hall..	2219	" Building..	2243	" Trunk (Wire)..	2278
" Hand..	2218	" Frame (Gilt)..	2242	" Tufting..	2277
" Mantel..	2219	" Frame (Plain)..	2242	" Upholsterers' ..	2277
" Pier..	2219	" Furniture..	2243	" Wire..	2278
" Plain..	2219	" Gilt..	2242	" Zinc..	2275
" Toilet..	2219	" Metal..	2241	Necklaces, Diamond..	2279
Mitts, Fur..	1559	" Room..	2243	Necklets, Teething..	2280
" Gauntlet..	2222	" Wood..	2243	Neckties, Cotton, Silk..	2281
" Harvest..	1558	Mounts, Photograph..	2258	Neckwear..	2281
" Knitted Wool..	2224	Mountings, Bell..	2256	Needles, Knitting Machine..	2282a
" Lined, Kid..	1558	" Halter..	2257	" Latch (Knitting Ma- chine) ..	2282
" Leather..	1558	Mowers, "Bell's Improved" ..	2260	Nests, Spice..	2283
" Outseam..	2223	" Front Cut, Rear Cut..	2262	Nets, Fly (Horse)..	2284
" Silk..	2221	" Lawn ("Woodyatt," "Philadelphia") ..	2261	" Tennis..	2284
" Unlined, Kid..	1558	" Lawn (Horse & Hand)..	2259	" Woven..	2284
Mittens, Buckskin..	1558	Mucilage, Liquid..	2263	Netting, Poultry (Wire)..	2286
" Rubber..	2220	" Red Seal..	2264	" Power Loom (Wire)..	2285
Mixers, Clay..	1071	Muffs, Fur..	1507	" Wire..	2286
" Cream..	3079	Mugs, Plated..	2265	Nippers, Cutting..	2287
Mixtures, Silk..	3088	Muriate of Ammonia..	2267	" of Copper..	2266
Mixture, Spice..	3172	" of Iron..	2267	" of Zinc..	2266
Moccasins, Beed..	2226	Mustard, French..	2268	" Ground..	2269
" Baby, Kid..	2226				
" Beef..	2225				
" Buck..	2225				
" Chamois..	2226				

INDEX TO ARTICLES.

	No.		No.		No.
Nipples,		Oil,		Ovens,	
"    and Nozzles (Brass		"    Refined.....	2319	"    Oil Stove.....	2343
Hydraulic.....	2290	"    Sewing Machine.....	2311	"    Portable.....	2344
Nitrate of Ammonia.....	28	"    Shoddiine.....	2314	Overalls.....	2397
"    of Copper.....	2292	"    Signal.....	2312	Overcoatings.....	1327
"    of Iron.....	2292	Oil, Soluble.....	2314a	Overgaiters, Cloth, Felt.....	2345
"    of Iron (True).....	2291	"    Term.....	2309	Overshoes, Rubber.....	3056
"    of Lead.....	1952	"    Grindle.....	2314	Ox Gall.....	2350
"    of Magnesia.....	2292	"    Tanners'.....	2312	Oxalate of Ammonia.....	29
"    of Mercury.....	2292	"    Turkey Red.....	2316	"    of Potassium.....	2584
"    of Potassium.....	2292	"    Valve.....	2313	"    of Sodium.....	3155
"    of Silver.....	2292	"    Wool.....	2312	Oxide of Antimony.....	37
"    of Sodium.....	2292	"    Wool (Olive).....	2314	"    of Copper.....	2348
Nitre, Spirits of.....	2293	"    Wine of Cod Liver.....	2315	"    of Gold.....	1567
Numbers, Door (Metal).....	2294	Oilers, Bicycle (Pocket).....	2321	Oxide of Manganese.....	2345a
"    Sign.....	2294	"    Brass.....	2322	"    of Silver.....	2348
Nurseries, Queen Bee.....	2295	"    Copper.....	2322	"    of Sodium.....	2348
Nuts, Axle.....	2302	"    Crank Pin.....	2322	"    of Zinc.....	2348
"    Case Hardened.....	2298	"    Engine.....	2322	"    of Iron.....	2348
"    Cold Punched.....	2302	Oils, Bicycle.....	2313	Oxides, Metallic.....	2349
"    Finished.....	2298	"    Car Axle.....	2313	"    Red.....	2346
"    Fish Plate.....	2299	"    Confectioners'.....	2317	"    Red (of Iron).....	2347
"    Hexagon.....	2301	"    Cylinder.....	2313	Oxymuriate of Antimony.....	37
"    Hot Pressed.....	2301	"    Dynamo.....	2313	"    of Tin.....	3484
"    Loop Head.....	2300	"    Engine.....	2313	Packers, Bran.....	2351
"    Machine Forged (Special		"    Essential.....	2317	"    Flour.....	2351
Sizes).....	2303	"    Fine Machine.....	2313	"    Shingle.....	2352
"    Malleable Iron.....	2300	"    Fruit.....	2317	Packing, Asbestos.....	55
"    Oblong.....	2297	"    Lard.....	2312	"    Cloth Insertion.....	2357
"    Railway Track.....	2299	"    Railway.....	2313	"    Cotton.....	2353
"    Semi-Finished.....	2298	"    Valve.....	2313	"    Engine.....	2353
"    Sleeve.....	2297	"    Waggon Axle.....	2313	"    Hydraulic.....	2360
"    Sleigh Shoe.....	2297	Oilcloth, Carriage.....	2320	"    Joint.....	2359
"    Small Cast.....	2300	"    Enamelled.....	2320	"    Locomotive.....	2359
"    Special.....	2298	"    Floor.....	2320	"    Metallic, Fibrous.....	2353
"    Square.....	2301	"    Shelf.....	2320	"    Piston.....	2353
"    Tapped.....	2304	"    Stair.....	2320	"    Plumbago.....	2358
"    Thumb.....	2300	"    Table.....	2320	"    Pump.....	2360
"    Top Prop.....	2296	Ointment, Gileadine.....	2323	"    Pure Rubber.....	2358
Oars, Sculling and Rowing.....	2305	"    Hoof.....	2325	"    Ring.....	2359
Oatmeal.....	2178	"    Magic.....	2324	"    Rod.....	2359
Offsets.....	2306	"    Mercurial.....	2328	"    Rope.....	2355
Oil, Axle.....	2313	Ointment, Petroleum.....	2328	"    Rubber.....	2357
"    Benzine.....	2312	"    Vegetable.....	2324	"    Rubber Back.....	2353
"    Boiled Linseed.....	2308	Ointments, Healing.....	2327	"    Rubber Spiral.....	2354
"    Bolt Cutting.....	2312	"    Vaseline.....	2326	"    Self-Vulvanizing.....	2353
"    Cedar.....	2307	Oleates.....	2329	"    Self-Vulvanizing	
"    Coal.....	2319	Openers, Can.....	2330	(Phoenix).....	2356
"    Cod Liver.....	2318	"    Envelope.....	2331	"    Sheet.....	2356
"    Confectioners'.....	2317	Organs, Cabinet Reed.....	2332	Pads, Shoe.....	2361
"    Creosote.....	2307	"    Church.....	2332	Pads, Bridge Collar.....	2365
"    Cylinder.....	2313	"    Parlor.....	2332	"    Desk Blotting.....	2364
"    Dynamo.....	2313	"    Pipe.....	2332	"    Stair (Folded Paper).....	2369
"    Engine.....	2313	"    Reed.....	2332	"    Stair (Wadded).....	2370
"    Fusel.....	2309	Ornaments, Brass.....	2336	"    Step.....	2368
"    Gasoline.....	2312	"    Church.....	2338	"    Teething.....	2366
"    Harness.....	2308	"    Dress.....	2334	"    Truss.....	2367
"    Illuminating.....	2319	"    Embossed Metal.....	2335	"    Writing.....	2364
"    Lard.....	2312	"    Mantle.....	2334	Paddles, Caroe.....	2362
"    Lofoten Cod Liver.....	2318	"    Metal, Lawn.....	3641	Padlocks, Bicycle.....	2363
"    Linseed.....	2308	"    Metal, Lawn.....	3641	Pails, Butter (Stoneware).....	2376
"    Machine.....	2313	"    Stove (Art Tile).....	2339	"    Candy.....	2375
"    Machine (Farmers').....	2312	"    Tower.....	2333	"    Factory.....	2373
"    Miners'.....	2312	"    Type.....	2337	"    Fire.....	2373
"    Naptha.....	2312	Ottomans, Upholstered.....	1506	"    Galvanized Iron.....	2371
"    Neatsfoot.....	2310	Outfits, Drive Well.....	2342	"    Honey.....	2372
"    Olive.....	2314	"    Grain Stacking.....	2341	"    Horse.....	2375
"    Paraffine.....	2312	"    Hay Stacking.....	2341	"    Ice Cream.....	2372
"    Petroleum.....	2319	Overmantels, Wood.....	2153	"    Jam.....	2375
"    Railway.....	2313	Ovens, Bakers' (Portable).....	2344	"    Lard.....	2378
		"    Bakers' (Stationary).....	2344		
		"    Camp Stove.....	2343		

INDEX TO ARTICLES.

Pails,	No.	Pans,	No.	Papers,	No.
" Leather	2380	" Stove	2393	" Plate	2410
" Milk	2371	" Sugar	2393	" Poster	2405
" Milk, Dairy	2371	" Umbrella	1739	" Sermon	2421
" Milk, Strainer	2371	" Vacuum	2395	" Straw Wrapping	2410
" Miners'	2377	Panels, Door	2390	" Super Calender	2406
" Mortar	2375	Pants, Cottonade	2397	" Tag	2423
" Oyster	2372	" Fishing (Rubber)	2396	" Tea	2405
" Oyster (Paper)	2379	Paper, Asbestos	2399	" Ticket	2405
" Pickle	2375	" Blank Book	2405	" Ticket (Cover)	2416
" Paint	2378	" Blotting	2411	" Tinted and Duplex	
" Pine	2375	" Book	2405	Coated	2416
" Putty	2378	" Bromide	2416	" Tissue	2409
" Railroad	2373	" Building	2401	" Toilet	2409
" Rubber	2374	" Butchers'	2410	" Tub-Sized Writing	2424
" Sap	2375	" Drug	2405	" Typewriter	2427
" Stable	2373	" Engine Sized Writing	2402	" Wall	2400
" Syrup	2375	" Express (Waterproof)	2403	" Waxed	2418
" Tobacco	2375	Paper, Flour Sack	2423	" Wrapping	2410
" Toy	2375	" Glazed	2416	" Wrapping (Manilla)	2423
" Water	2375	" Glazed Surface	2416	" Writing	2417
" White Oak	2375	" Hardware	2410	Papeteries	2428
" Wood	2375	" Lining	2401	Papeteries, Special Brands	2429
Paints, Barrel	2384	" Music	2405	Parasols, Lodge	2430
Barrel (Church's Dry		" Negative	2416	Parasols, Children's Carriage	2431
Sized)	2387	" News	2413	Parers, Fruit	2432
" Bridge	2381	Paper, Roofingb	2401	Paris, Plaster of	2433
" Bronze	2382	" Surface Sized Writing	2398	Parts, Bicycle	2434
" Carriage	2381	" Sheathing (Dry)	2401	" Locomotive	2029
" Copper	2385	" Soap Wrapping (Alkali		Paste, Axle (Vaseline)	2435
" Dipping	2382	Proof)	2404	" Boot and Shoe	1209
" Dry Mineral	2384	" Tarred	2401	" Tan Shoe	2573
" Elastic	2382	" Toilet	2409	" Stove	2573
" Enamel	2382	" Trunk	2410	Pastels, Wood	2436
" Face (Theatrical)	2383	" Waterproof	2401	Patterns, Lettered	2438
" Face (Vaseline)	2383	Papers, Art	2416	" Machinery	2437
" Fire Proof	2381	" Bank Note	2417	" Wood	2437
" Floor	2381	" Brown	2410	Pavements, Concrete	2485
" Graphite	2386	" Bag	2423	Peas, Canned	611
" Iron Roof	2381	" Bond	2406	" Split	135
" Liquid	2382	" Carbon	2419	Peaches, Canned	611
" Metallic (Dry)	2384	" Card	2410	Pears, Canned	611
" Mixed	2381	" Chromo	2412	Pedals, Bicycle	2441
" Railway	2381	" Coated Book	2416	" Piano	2439
" Roof	2381	" Coated Chromo	2416	Pedestals, Shaft	2440
" Ship	2381	" Colored	2415	Peel, Candied	2443
" Water-proof	2381	" Colored Writing	2402	" Citron	2443
" Wood Filler "Church's"	2387	" Copying	2417	" Lemon	2443
Pallets, Brick	2389	" Cover	2410	" Orange	2443
Pancreatin, Liquid	1176	" Drawing	2412	Pegs, Shoe	2444
" Powdered	1176	" Enamelled	2416	Pegwood, Machine	2444
" Pure	1176	" Envelope	2405	Pendants, Diamond	2445
" Saccharated	1176	" Fly	2407	" Gas	2446
Pans, Bakers' (Iron)	2395	" Foolscap	2424	Penstocks, Turbine Wheel	2447
" Bed Rubber	2466	" Gummed	2408	Pepper, Black	2449
" Bed (Rockingham Ware)	2394	" Gummed Surface	2408	" Ground	2449
" Bread (Iron)	2395	" Half-Tone	2416	" Cayenne	2449
" Cake	2395	" Hanging	2425	" White	2449
" Cake (Iron)	1739	" Label	2412	Peppers and Salts, Plated	2448
" Confectioners'	1893	" Ledger and Record	2417	Pepsin	2450
" Copper	1893	" Legal	2424	" Aseptic	1176
" Dry Clay	2392	" Linen	2420	" Cordial	1176
" Frying	1739	" Lithograph	2412	" Glycerole	1176
" Hat Rack	1739	" Machine Finished	2406	" Lactated	1176
" Mining	2393	" Match Box	2414	" Liquid	1176
" Ore	2393	" Map	2424	" Saccharated	1176
" Quartz	2393	" Manilla	2423	Perambulators	644
" Salt Well	2393	" Manilla (Writing)	2417	Perfumery	2452
" Sauce and Stew	2391	" News	3841	Pessaries, Rubber	2453
" Seamless (Iron)	1739	" Note	2422	Pews, Church	2454
" Sheet Iron	2393	" Note (Special Brands)	2426		



INDEX TO ARTICLES.

	No.	Pincers,	No.	Planers,	No.
Phaetons	646	" Steel	3659	" Frog and Switch	2506
Phosphates, Acid	2455	" Pineapples, Canned	611	" Heading	2507
" Liquid (Acid)	2456	Pinions, Iron and Steel	2470	" Hoop	2507
" Powdered (Acid)	2456	Pipe, Concrete Stone	2485	" Locomotive Rod	2506
Pianos, Square	2457	" Copper	2489	" Metal	2506
" Upright	2457	" Culvert (Cast Iron)	2488	" Metal Plate	2506
Picks, Earth	2461	" Culvert (Cement)	2486	" Rotary	2506
" Ice	1644	" Drain (Cast Iron)	2488	" Ship Plate	2506
" Mill	1644	" Drain (Cement)	2486	" Stave	2507
" Miners'	2461	" Drive Well	2483	" Wood	2509
" Prospecting	2461	" Flange	2488	Planers and Matchers	2509
" Quarry	2461	" Flexible Play (Rubber)	2494	Planer and Matcher Comb	
" Railroad	2461	" Galvanized Iron	2490	(Double Surface)	2505
" Stone	2461	" Gas (Cast Iron)	2488	Plants, Contractors'	2515
" Tamping	2461	" Lead	2484	" Mining	2513
Pickers, Burr	2458	" Lead (Tin Lined)	2484	" Power	2514
" Feeder	2458	" Oil Line	2483	" Steam	2514
" Shoddy	2458	" Pressure	2488	Planters, Corn (Hand)	2511
" Wood	2458	" Rustless Iron	2488	" Drill Marking Tobacco	2512
Pickets, Fence	2459	" Salt Glazed Culvert	2482	" Potato (Horse)	2510
Pickles, Bulk	2460	" Salt Glazed Drain	2482	Plaster, Calcined	2516
" "John Bull" Mustard	2460	" Salt Glazed Sewer	2482	" Land	2516
" Mixed	2460	" Sewer (Cast Iron)	2488	" Paristone	2516
" Spiced (Sweet)	2460	" Sewer (Cement)	2486	" of Paris	2433
Piers, Iron and Steel	2462	" Soil (Cast Iron)	2488	" Wall	2516
Piles, (Wood) Foundation	2463	" Stove	2491	Plasters, Belladonna	2517
" (Wood) Pier	2463	" T	2488	" Medicated	2517
Pills, Blue	2467	" Vitified	2482	Plate, Boiler (Printers)	2519
" Coated	2467	" Waterworks	2487	" Ornamental Tin	2518
" Compressed	2467	" Wrought Iron	2483	Plates, Angle	2527
" Pink	2469	Pipes, Chimney	2495	" Bed (Brass)	2545
" Quinine	2468	" Clay	2497	" Bed (Iron)	2524
" Quinine (Capsule Shaped)	2468	" Clay (Fancy)	2497	" Bench	2540
" Soluble	2467	" Conductor (Iron)	2498	" Boiler (Iron)	2526
" S. C.	2467	" Conductor (Sheet Iron)	2499	" Boiler (Steel)	2526
" Vegetable	2467	" Expansion	2498	" Bolster	2528
Pilloids, Haemoferrum	2464	" Galvanized Iron	2498	" Bridge	2529
" Haemoglobin	2464	" Hawser	2496	" Carriage Name	2545
Pillows, Air (Rubber)	2466	" Hose	2492	" Ceiling	2521
" Down	2465	" Iron Riveted	2492	" Cesspool	2541
" Feather	2465	" Stand	2492	" Church (Brass)	2545
" Hair	2465	Pistons, Engine	2500	" Coffin	2523
" Wool	2465	" Locomotive	2500	" Collection (Brass)	2545
Pins, Belaying	2479	Pitch, Paving	2501	" Collection (Wooden)	2454
" Clothes (Spring)	2477	" Roofing	2501	" Die	2544
" Clothes (Wire)	2481a	Pitchers, Plated	2502	" Door Name	2545
" Clothes (Wood)	2476	Plaids, Costume	867	" Dry	2525
" Coupling	2472	Placques, Brass	2503	" Expansion	2521
" Crank	2480	Planes, Adjustable	2504	" Face	2530
" Cuff	2473	" Bead	2504	" Felloe	2531
" Cross Arm	2478	" Bench	2504	" Finger and Guard	2522
" Escutcheon (Brass)	2472	" Carpenters'	2504	" Fish	2532
" Escutcheon (Iron)	2472	" Iron Throat	2504	" Floor	2521
" Escutcheon (Steel)	2472	" Jointers'	2504	" Floating	2540
" Gold	2473	" Match	2504	" Heel	2543
" Hair (Jewelry)	2473	" Moulding	2504	" Hinge	2542
" Hinge	2472	" Rabbet	2504	" Hook	2521
" Insulator	2478	" Routing	2504	" Letter Box	2545
" (Jewelry)	2473	Planer, Matcher and Moulder		" Memorial	2545
" Nursery	2471	(Combined)	2509	" Mirror	2538
" Ribbon	2474	Planers, Bed	2505	" Music	2539
Pins, Rolling	3591	" Buzz	2509	" Nail	2526
" Safety Spring	2471	" Crank	2506	" Name	2545
" Scarf (Diamond)	2473	" Cut Gear (Endless)	2505	" Pipe Hook	2521
" Shawl	2473	" Cut Gear (Single and		" Railway Rail	2532
" Telegraph	2478	Double Surface)	2505	" Reaper and Mower	2522
" Ten	2475	" Cut Gear (Double Sur-		" Radiator Floor	2533
" Tent	2568	face Pony)	2505	" Roofing (Steel)	2520
" Toilet	2474	" Emery	2508	" Screw	2544
Pincers, Farriers'	3669			" Siding (Steel)	2534

INDEX TO ARTICLES.

	No.		No.		No.
Plates,				Powers,	
“ Sign . . . . .	2545	Pop, Ginger . . . . .	20	“ Horse, “ Pitt’s ” . . . . .	2607
“ Stair (Brass) . . . . .	2545	Porcelain Ware . . . . .	3688	“ Horse (Sweep) . . . . .	2608
“ Stencil . . . . .	2535	Pork . . . . .	2576	“ Horse (Threshing) . . . . .	2608
“ Step (Brass) . . . . .	2545	Pork Hams . . . . .	2576	“ Horse (Tread) . . . . .	2608
“ Stereotype . . . . .	2537	“ Heavy . . . . .	2576	Preparations, Beef . . . . .	2610
“ Wall . . . . .	2520	“ Mess . . . . .	2576	“ Cascara Bark . . . . .	2611
Plates, Wooden . . . . .	1184	“ Shoulder Mess . . . . .	2576	“ Effervescent . . . . .	2610
Pliers, Wire . . . . .	2546	“ Sausage . . . . .	2577	“ Food . . . . .	2609
Plows, Cast . . . . .	2549	“ Short Cut . . . . .	2576	“ Granular . . . . .	2610
“ Combined Walking and Riding . . . . .	2550	Porter, Ale and Stout . . . . .	19	“ Kola Nut . . . . .	2611
“ Contractors’ (Corpora- tion) . . . . .	2549	Portfolios, (Music) . . . . .	2578	“ Special Medicinal . . . . .	2609
“ Ditching . . . . .	2549	“ Sketch . . . . .	2578	Preservers, Life (Cork and Can- vass . . . . .	2613
“ Gang . . . . .	2551	Posts, Cedar Fence . . . . .	2579	“ Life (Rubber) . . . . .	2612
“ Garden . . . . .	2550	“ Gas . . . . .	2582	Preserves, Canned . . . . .	611
“ Grading . . . . .	2549	“ Hitching (Iron) . . . . .	2581	“ Raspberry . . . . .	2615
“ Ice . . . . .	2551	“ Hydrant . . . . .	2582	“ Strawberry . . . . .	2615
“ Landside . . . . .	2551	“ Iron Fence . . . . .	2582	“ Table Fruit . . . . .	2615
“ Nursery . . . . .	2550	“ Lamp (Iron) . . . . .	2582	Presses, Bench (Sheet Metal) . . . . .	2630
“ Railway Snow . . . . .	2548	“ Newell . . . . .	2580	“ Brick . . . . .	2632
“ Riding Gang . . . . .	2550	“ Stable Stall . . . . .	2581	“ Buggy Wheel Box . . . . .	2635
“ Shovel . . . . .	2551	Pots, Bean . . . . .	2592	“ Can . . . . .	2631
“ Side Hill . . . . .	2551	“ Butter . . . . .	2586	“ Car Wheel . . . . .	2628
“ Sod and Stubble . . . . .	2551	“ Cast Iron Charcoal . . . . .	2588	“ Card Printing . . . . .	2636
“ Steel . . . . .	2549	“ Earthen . . . . .	2592	“ Cheese (Single) . . . . .	2629
“ Subscil . . . . .	2551	“ Coffee (Plated) . . . . .	2590	“ Cider . . . . .	2627
“ Sulky . . . . .	2550	“ Coffee and Tea . . . . .	2586	“ Copying . . . . .	2626
“ Walking . . . . .	2551	“ Cooking . . . . .	1739	“ Copying Roller . . . . .	2617
“ Wheel . . . . .	2550	“ Cream . . . . .	2586	“ Cylinder Job . . . . .	2636
“ Wheel Gang . . . . .	2550	“ Flower . . . . .	2592	“ Cylinder Printing . . . . .	2636
Plugs, Brass . . . . .	2555	“ Glass . . . . .	2587	“ Drill . . . . .	2625
“ Cast Iron . . . . .	2554	“ Glue . . . . .	1739	“ Embossing (Sheet Metal) . . . . .	2630
“ Deck . . . . .	2555	“ Marking . . . . .	2591	“ Foot Power . . . . .	2636
“ Fusible . . . . .	2555	“ Ore . . . . .	2589	“ Fruit . . . . .	2650
“ Roll Paper . . . . .	2553	“ Rockingham Ware . . . . .	2586	“ Gang Cheese . . . . .	2637
“ Rubber . . . . .	2552	“ Soldering . . . . .	1739	“ Gang Cheese (Patent Continuous) . . . . .	2638
Plugs, Wooden . . . . .	3175	“ Stag . . . . .	2589	“ Hand (Power) . . . . .	2636
Plumbago . . . . .	2555a	“ Stone . . . . .	2592	“ Hay . . . . .	2616
Pockets, Wall (Bamboo) . . . . .	2556	“ Stone Ware . . . . .	2586	“ Hay (Derrick Patent) . . . . .	2619
Pocketbooks . . . . .	2705	“ Stove . . . . .	1739	“ Heel . . . . .	2119
Pedophyllin . . . . .	2557	“ Tinnors’ Fire . . . . .	1739	“ Horse Power . . . . .	2616
Poison, Bug . . . . .	2563	Potash . . . . .	2583	“ Hydraulic . . . . .	2624
Points, Drive Well . . . . .	2561	Potash, Ammoniated . . . . .	2583	“ Hydraulic Baling . . . . .	2633
“ Frog . . . . .	2559	“ Caustic . . . . .	2584	“ Hydrostatic Wheel . . . . .	2628
“ Glaziers’ . . . . .	2560	Potassium, Carbonate . . . . .	2584	“ Job . . . . .	2636
“ Jacket (Brass) . . . . .	2561	“ Oxalate . . . . .	2584	“ Lever Foot . . . . .	2630
“ Picture Frame . . . . .	2560	“ Sulphate . . . . .	2584	“ Lever Hand . . . . .	2630
“ Plow . . . . .	2551	“ Sulphuret . . . . .	2585	“ Lithographic . . . . .	2636
“ Washer . . . . .	2558	Pottery, Artistic . . . . .	2586	“ Newspaper . . . . .	2636
Pointers, Hoop . . . . .	2562	“ Decorated . . . . .	2586	“ Paper Bag . . . . .	2629
Pokers, Firing . . . . .	2564	Pouches, Music . . . . .	2594	“ Printing (Book) . . . . .	2636
“ Stove . . . . .	2564	Poultry, Canned . . . . .	612	“ Power . . . . .	2623
“ Animal . . . . .	2565	Pounders, Beef Steak (Wood) . . . . .	2595	“ Printing . . . . .	2618
Pokes, Animal . . . . .	2565	Powder, Asbestos . . . . .	2602	“ Punching . . . . .	2621
Poles, Corrice (Wood) . . . . .	2567	“ Baking . . . . .	2596	“ Shearing . . . . .	2628
“ Curtain (Brass) . . . . .	2570	“ Baking (Eagle) . . . . .	2597	“ Sheet Metal . . . . .	2623
“ Fish . . . . .	2823	“ Baking (Newman’s) . . . . .	2599	“ Shingle . . . . .	2622
“ Electric Light (Iron) . . . . .	2572	“ Baking (Vienna) . . . . .	2598	“ Soap . . . . .	2620
“ Curtain (Wood) . . . . .	2567	“ Blasting . . . . .	2601	“ Stamping . . . . .	2620
“ Pike . . . . .	2566	“ Custard . . . . .	2600	“ Tile . . . . .	2632
“ Telegraph . . . . .	2571	“ Flash . . . . .	2601	“ Tobacco . . . . .	2639
“ Tent . . . . .	2568	“ Giant . . . . .	2601	“ Wet (Pulp Mill) . . . . .	2634
“ Trolley . . . . .	2572	“ Gun . . . . .	2601	“ Wine . . . . .	2627
“ Vehicle . . . . .	2569	“ Sportsmans’ . . . . .	2601	“ and Moulds (Tobacco) . . . . .	2639
Polish, Furniture . . . . .	2574	Powders, Bronze . . . . .	2604	Pressers, Cork . . . . .	2614
“ Shoe . . . . .	2573	“ Condition . . . . .	2603	Primers, Powder . . . . .	2640
“ Silverware . . . . .	2575	“ Heave . . . . .	2603	Printers, Butter . . . . .	2641
“ Stove (Liquid) . . . . .	2573	“ Soap . . . . .	2606	Programmes, Entertainment . . . . .	2642
“ Tan Shoe . . . . .	2573	“ Toilet . . . . .	2605		
		Powers, Horse . . . . .	2607		

INDEX TO ARTICLES.

	No.	Pumps,	No.	Punches,	No.
Props, Carriage Top. . . . .	2643	"	Combined Air & Boiler	"	Hollow. . . . . 2695
Protectors, Chest. . . . .	2645	"	Feed. . . . . 2675	"	Lever. . . . . 2695
" Counter (Brass). . . . .	2644	"	Combined Air and Con-	"	Lever (Hand Power). . . . . 2695
" Skirt. . . . .	2646	"	densers. . . . . 2675	"	Pin. . . . . 2697
Pruners, Tree. . . . .	2647	"	Compound. . . . . 2693	"	Prick. . . . . 2697
Publications, Daily & Weekly. . . . .	3841	"	Cornish. . . . . 2694	"	Saw. . . . . 2696
" Musical. . . . .	385	"	Crank. . . . . 2688	"	Sheet Metal. . . . . 2695
Pucks, Hockey. . . . .	2651	"	Cylinder (Iron). . . . . 2692	"	Solid. . . . . 2695
Pulls, Bell. . . . .	2662	"	Deep Well. . . . . 2674	"	and Shears. . . . . 2698
" Door. . . . .	2662	"	Distillery. . . . . 2691	"	and Shears, Boiler
" Drawer. . . . .	2662	"	Drainage. . . . . 2692	"	Plate. . . . . 2698
" Escutcheon. . . . .	2662	"	Drive Well. . . . . 2674	"	and Shears, Hand. . . . . 2699
" Screen Door. . . . .	2662	"	Duplex Flywheel. . . . . 2672	"	and Shears, Hydraulic. . . . . 2698
" Sliding Door. . . . .	2662	"	Duplex (Steam). . . . . 2693	"	and Shears, Power. . . . . 2698
" Trap. . . . .	2662	"	Elevator. . . . . 2682	Purifier, Boiler. . . . . 2701	
" Window Blind. . . . .	2662	"	Fire. . . . . 2693	" Boiler (Cedar Extract). . . . . 2700	
" Window Sash. . . . .	2662	"	Force Feed. . . . . 2691	Purifiers, Corn Meal. . . . . 2703	
Pullers, Nail and Hammer (Com-		"	Force (Plumbers). . . . . 2691	" Feed Water. . . . . 2702	
" bined). . . . .	2654	"	Force (Steam). . . . . 2693	" Live Steam. . . . . 2704	
" Nail. . . . .	2653	"	Garden. . . . . 2674	" Middlings. . . . . 2703	
" 2Stump. . . . .	2649	"	Greenhouse. . . . . 2674	" and Aspirators, Corn	
" Tack. . . . .	2653	"	Injection. . . . . 2679	" Meal. . . . . 57	
Pulleys, Awning. . . . .	2660	"	Iron. . . . . 2674	Purses. . . . . 2705	
" Balanced (Clutch). . . . .	2661	"	Hand (Brass). . . . . 2691	Putty, Glaziers', Painters'. . . . . 2707	
" Clothes Line. . . . .	2660	"	Hand (Iron). . . . . 2690	" Stove. . . . . 2706	
" Cone. . . . .	2661	"	Hydraulic. . . . . 2671	Quills, Cotton Mill. . . . . 2708	
" Flanged. . . . .	2661	"	Lawn. . . . . 2674	Quinine. . . . . 2709	
" Friction Clutch. . . . .	2661	"	Lift (Air). . . . . 2686	Quoits, Pitching. . . . . 2710	
" Furnace. . . . . 2658		"	Locomotive. . . . . 2677	Racks, Broom. . . . . 2713	
" Groove. . . . . 2661		"	Low Pressure. . . . . 2681	" Church Pew (Wood). . . . . 2717	
" Guide. . . . . 2661		"	Marine. . . . . 2692	" Church Pew Book	
" Grip. . . . . 2661		"	Milk. . . . . 2684	" (Metal). . . . . 2716	
" Hardware. . . . . 2660		"	Mining. . . . . 2692	" Circle and Corner. . . . . 2720	
" Hay Carrier. . . . . 2659		"	Nickle Lined. . . . . 2679	" Clothes. . . . . 2716	
" Hay Fork. . . . . 2660		"	Oil. . . . . 2683	" Hall. . . . . 2719	
" Hub (Wood Split). . . . . 2655		"	Oil (Cylinder). . . . . 2691	" Hat and Hat (Bamboo). . . . . 2721	
" "Iron Arm". . . . . 2656		"	Orchard. . . . . 2674	" Hanging. . . . . 2712	
" Sash. . . . . 2660		"	Paper Mill. . . . . 2693	" Hat and Coat (Wood). . . . . 2719	
" Screw. . . . . 2660		"	Pitcher. . . . . 2690	" Hat and Coat (Brass). . . . . 2716	
" Small Iron. . . . . 2660		"	Plumbers'. . . . . 2691	" Hat and Coat (Iron). . . . . 2716	
" Special. . . . . 2661		"	Pneumatic. . . . . 2686	" Hay (Iron). . . . . 2720	
" Split. . . . . 2656		"	Pulp Mill. . . . . 2693	" Hay (Wood). . . . . 2711	
" Swivel. . . . . 2660		"	Quarry. . . . . 2692	" Hose. . . . . 2715	
" Wedge Rack. . . . . 2657		"	Rotary. . . . . 2688	" Pen. . . . . 2713	
" Wood Split. . . . . 2655		"	Sewerage. . . . . 2692	" Printers' Galley. . . . . 2718	
Pulp, Asbestine. . . . . 2666		"	Ship. . . . . 2692	" Stock (Wood). . . . . 2711	
" Wood. . . . . 2665		"	Siphon. . . . . 2685	" Toast (Wire). . . . . 2714	
" Wood (Sulphite Fibre). . . . . 2663		"	Soap. . . . . 2680	" Towel (Brass). . . . . 2716	
Pulpers, Root. . . . . 2667		"	Special. . . . . 2683	" Towel (Metal). . . . . 2716	
Pulpits. . . . . 2454		"	Spray. . . . . 2674	Racks, Towel (Wood). . . . . 3591	
Pulverizers, Black Lead. . . . . 2669		"	Spray (Knapsack). . . . . 2678	" Whip. . . . . 2713	
" Foundry Facing. . . . . 2669		"	Steam. . . . . 2693	Rackets, Tennis. . . . . 2284	
" (Mining). . . . . 2668		"	Suction (Hand). . . . . 2683	Radiators, Artistic. . . . . 2723	
" Plumbago. . . . . 2669		"	Tank (Threshers). . . . . 2678	" Circle. . . . . 2723	
Pulverizers, Rotary Disk. . . . . 2670		"	Tannery. . . . . 2693	" Cast Iron. . . . . 2722	
" Spice. . . . . 2669		"	Veterinary. . . . . 2679	" Domestic. . . . . 2722	
" Sugar. . . . . 2669		"	Vinegar. . . . . 2691	" Flat Circle. . . . . 2723	
Pumps, Air. . . . . 2689		"	Well Sand. . . . . 2683	" Hotel. . . . . 2722	
" Air (Duplex). . . . . 2689		"	Whey. . . . . 2685	" Hot Water. . . . . 2722	
" Anti-Freezing. . . . . 2674		"	Windmill. . . . . 2674	" Office. . . . . 2722	
" Artesian Well. . . . . 2674		"	Wooden. . . . . 2674	" Public Building. . . . . 2722	
" Beer and Ale (Brass). . . . . 2691		"	Wrecking. . . . . 2692	" Safford. . . . . 2723	
" Bicycle. . . . . 2676		"	(Boiler) and Heater	" Steam. . . . . 2722	
" Boiler Feed. . . . . 2673		"	Combined (Cornish). . . . . 2694	" Vertical Tube. . . . . 2722	
" Brass Lined. . . . . 2679		Pumpkin, Canned. . . . . 611		Radish, Horse. . . . . 2724	
" Breast (Rubber). . . . . 2687		Punches, Bell. . . . . 2697		Rails, Barn Door. . . . . 2729	
" Brewery. . . . . 2691		" Blacksmiths'. . . . . 2697		" Carriage (Foot). . . . . 2738	
" Centrifugal. . . . . 2693		" Center. . . . . 2697		" Curved. . . . . 2734	
" Cheese Factory. . . . . 2685		" Hand. . . . . 2697		" Cutter. . . . . 2738	
" Cistern. . . . . 2690					

INDEX TO ARTICLES.

Rails,	No.	Reamers,	No.	Repairs,	No.
" Dash...	2738	" Finishing...	2755	" Steamboat...	2786
" Door...	2729	" Fluted...	2755	" Vessel...	2786
" Door (Brass)...	2737	" Locomotive Work...	2754	Rests, Carriage...	2788
" Frog...	2735	" Pipe...	2753	" Prop...	2788
" Guard (Brass and Iron)...	2729	" Rose Shell...	2754	" Slide...	804
" Mine...	2732	" Roughing...	2754	" Stove Foot...	2787
" Picket (Fence)...	2733	" Shell...	2754	Retorts, Canning...	2790
" Shifting...	2736	" Solid...	2754	" Cast Iron...	2790
" Sliding Door...	2729	" Square...	2754	" Gas...	2789
" Stove...	2731	" Standard...	2754	" Processing...	2790
" Street Railway...	2730	" Taper...	2754	" and Condensers, Amal-	
" Wing...	2735	" Taper Tin...	2754	gan...	2790
" Altar (Brass)...	2726	Reapers, Grain...	2757	Ribbons, Silk...	3088
Railings, Altar (Brass)...	2726	" "The Victor"...	2756	" Typewriter...	2791
" Altar (Iron)...	2727	Receivers, Card (Plated)...	2759	Rigs, Saw (Circular)...	2794
" Altar (Wood)...	2728	" Telephone...	2758	" Saw (Drag)...	2794
" Balcony (Iron)...	2727	Reducers, Pipe (Cast Iron)...	2760	" Wire Rope...	2792
" Balcony (Wood)...	2728	Reeds, Lcom...	2762	" Wire Rope Tramway	
" Bank & Office (Brass)...	2726	" Organ...	2761	Dumping...	2792
" Bank & Office (Iron)...	2727	Reels, Centrifugal...	2765	Rigging, Wire Rope...	2792
" Bank & Office (Wire)...	2725	" Clothes Line...	2763	Rims, Bicycle (Wood)...	2796
" Bank & Office (Wood)...	2728	" Cylindrical, Flour...	2765	" Carriage Wheel...	3809
" Cemetery...	2727	" Folding Clothes...	2767	Rimmers, Pump...	2795
" Counter (Brass)...	2726	" Hose (Garden)...	2768	Rings, Bull...	2806
" Desk (Brass)...	2726	" Hose (Fire)...	2764	" Clinch...	2801
" Hand (Brass)...	2726	" Hose (Lawn)...	2768	" Cleirs...	2806
" Office (Wood)...	2728	" Revolving Clothes...	2767	" Curtain Pole (Brass)...	2804
" Vault...	2727	" Round...	2765	" Curtain Pole (Nickle)...	2804
Railways, Cash and Parcel...	2739	" Yarn...	2766	" Diamond...	2805
Rakes, Asphalt...	2740	Reflectors, Chandelier...	2769	" Far...	2805
" Cast Iron...	2741	" Gas Light...	2769	" Fibrous...	2804a
" Drag...	2742	" Lamp...	2769	" Fruit Jar (Rubber)...	2798
" Garden...	2742	Refrigerators, Arctic...	2772	" Gold...	2805
" Hand (Cast Iron)...	2741	" "Brantford"		" Gold Engraved...	2805
" Hand (Wood)...	2742	Hardwood...	2770	" Hatter...	2802
" Hay...	2743	" Butchers'...	2772	" Haine...	2802
" Hay (Foot Dump)...	2744	" Cold Water...	2771	" Harness...	2802
" Hay (Ithaca)...	2743	" Counter...	2770	" Hitching...	2806
" Hay (Sulky)...	2744	" Domestic...	2771	" Hog...	2806
" Hay (Tiger)...	2743	" Filter...	2771	" Key...	2803
" Malleable Iron...	2741	" Grocers'...	2772	" Martingale...	2802
" Wood...	2742	" Hotel...	2772	" Plate...	2806
Rams, Hydraulic...	2745	" Household...	2772	" Post...	2806
Ranges, Cast Iron...	2749	" Lager Beer...	2770	" Rubber...	2798
" Cooking...	2749	" Show Case...	2771	" Scarf...	2805
" Dining Car...	2747	" Table Top...	2770	" Solid Gold, Stone...	2805
" Gas...	2746	Registers, Cash "McEwan"...	2774	" Teething (Rubber)...	2799
" Hotel...	2749	" Floor and Wall Ven-		" Tie Plate...	2806
" Kitchen...	2749	tilating...	2778	" Trap Door...	2806
" Restaurant...	2747	" Guest...	2776	" Umbrella...	2798
" Steel...	2747	" Hot Air...	2778	" Wedding...	2805
" Steamboat...	2749	" Hotel...	2776	" Wood...	2800
" Wrought Iron...	2748	" Lumbermen's Measur-		Ringers, Hcg...	2797
Raspberries, Canned...	611	ing...	2775	Rivets, Belt...	2811
Rasps, Blacksmiths'...	2750	" Smoke Pipe...	2773	" Boiler...	2814
" Cabinetmakers'...	2750	" Telegraph...	2777	" Brass...	2810
" Horseshoers'...	2750	Regulators, Beer Pressure...	2779	" Bridge...	2814
" Ironworkers'...	2750	" Damper (Electric		" Black Stone...	2811
" Plumbers'...	2750	Pressure)...	2783	" Bronze...	2807
" Shoemakers'...	2750	" Damper...	2784	" Carriage...	2813
" Veterinary...	2750	" Gas Pressure...	2779	" Carriage Top...	2808
" Woodworkers'...	2750	" Heat...	2784	" Coopers'...	2811
" and Files...	2750	" Speed...	2782	" Copper...	2811
Rattlers, (Anti) Shaft...	2751	" Steam Boiler...	2780	" Guard...	2811
Razors...	2752	" Steam Pressure...	2779	" Hame...	2811
Reamers, Adjustable...	2754	" Thread Power Speed	2782	" Hose...	2811
" Bit Brace...	2754	" Water Pressure...	2779	" Hose...	2811
" Center...	2754	" Wind Mill...	2781	" Iron...	2811
" Chucking...	2755	Relays, Telegraph...	2785	" Refrigerator...	2811
" Expansion...	2754	Repairs, Ships...	2786		

INDEX TO ARTICLES.

Rivets,	No.	Rolls,	No.		No.
" Section	2811	" Field	2841	Rosettes, Brass	2864
" Shackle	2811	" Gaff	2833	" Harness	2863
" Shoe (Copper)	2810	" Garden	2840	" Iron	2865
" Shoe (Iron)	2810	" Gate	2839	" Metal	2866
" Shovel	2811	" Hearse	2839	" Turned	2863
" Sleigh Shoe	2811	Rollers, Barn Door	2839	" Walnut	2863
" Slotted	2811	" Blind	2832	" Wood	2863
" Smoke Stack	2811	" Blind (Square Pine)	2837	Rough Stuffs	2867
" Sink	2811	" Field	2841	Rounds, Ladder	2868
" Steel	2812	" Gaff	2833	Rubber Goods, Druggists'	2869
" Steel Norway	2807	" Garden	2840	" Goods, Soft	2869
" Tinned	2810	" Gate	2839	Rudders, Ships	2870
" Tinners'	2811	" Hearse	2839	Rugs, Animal	2871
" Trunk	2811	" Inclined Plane	2839	" Axminster	2875
" Tubular	2811	" Land	2841	" Carriage	2877
" Waggon	2811	" Land (Schafer Attach- ment)	2838	" Carriage (Children's)	2877
" Wheel	2811	" Lawn	2840	" Fur	1507
" Wire	2810	" Log	2836	" Ingrain	2875
Roasters, Coffee	2815	" Packing House	2831	" Lap	2876
Robes, Baptismal	2816	" Rubber (Hard)	2835	" Mountain Goat	2871
" Bear	1507	" Sash	2839	" Oil Cloth	2872
" Burial	2817	" Self-Acting Shade	2832	" Oil Lap	2873
" Fur	1507	" Shade	2832	" Reindeer	2871
Rockers, Cobbler	2818	" Shutter	2839	" Sheepskin (Hearth)	2874
Rockingham Ware	2819	" Sliding Door	2839	" Smyrna	2876
Rods, Brake	2820	" Towel	3591	" Travelling	2876
" Bridge	2830	" Trunk	2839	" Venetian	2876
" Bridge Sway	2830	" Wringer (Rubber)	2835	" Wool, Floor and Door	2877
" Building	2830	Roofing, Actinolite	2853	Rules, Hickory, Lumbermen's	2879
" Connecting	2820	" Asbestos	55	" Hickory, Log	2879
" Dowel	2824	" Asphalt	2857	" Printers'	2878
" Fishing (Cane)	2823	" Car	2852	Runners, Children's Carriage	2881
" Fishing (Salmon)	2823	" Cement	2857	" Double	3809
" Fishing (Trout)	2823	" Corrugated	2856	" Hub	3809
" Glass	2828	" Elevator (Steel)	2856	" Sleigh	3809
" Mitering	2822	" Felt	2857	Runways, Packing House	2889
" Nail	2821	" Fireproof	2857	Sacks, Paper	2882
" Picture (Brass)	2829	" Galvanized Iron	2855	Sacks, Flour	2882
" Piston	2820	" Iron	2854	" Flour (Paper)	2882
" Pump	2826	" Lightning Proof	2856	" Wool	2883
" Roof	2830	" Metallic	2852	Sad Irons, Cold Handle	1842
" Stair	2827	" Grain	2856	" Gas Heating	1842
" Stair (Brass)	2820	" Pitch	2857	" Laundry	1842
" Stove	2827	" Slate	2855	" Mrs. Pott's	1837
" Towel Stone	2825	" Steel	2854	" Tailors'	1842
" Truss	2830	" Steel, "Thorn's Pat."	2856	Saddles, Bicycle	2884
" Window (Iron)	2827	" Tarred	2857	" Cart	2885
" Bleaching	2850	" Tile	2855	" Coupé	2885
Rolls, Chilled Iron	2845	" Tamed Steel	2856	" Cow Boys'	2885
" Cornish	2842	Roofs, Iron and Steel	2858	" Express	2885
" Crushing	2842	Roots, Dried	2859	" Gig	2885
" Dating	2849	Rope, Asbestos	55	" Ranching	2885
" Embossing	2849	" Bale	2861	" Riding	2885
" Engraving	2849	" Ballasting	2862	" Side	2885
" Flour Mill	2845	" Bell	2861	" Track	2885
" Grindstone	2844	" Braided	2861	Safes, Bank and Office	2887
" Hip (Terra Cotta)	2846	" Clothes Line	2861	" Burglar and Fire Proof	2887
" Jewelers'	2847	" Cotton	2861	" House	2887
" Machinists'	2847	" Elevator (Wire)	2862	" Jewelers'	2887
" Mangle (Maple)	2848	" Locomotive	2862	" Match	2886
" Moulding	2849	" Jute	2861	" Silk Factory	2887
" Numbering	2849	" Manila and Sisal	2861	" Specie	2887
" Paper Mill	2843	" Rigging (Wire)	2862	" Toy	2886
" Plate Bending	2851	" Skipping	2861	" and Vaults	3648
" Rolling Mill	2851	" Switch	2862	Sails, Canoe	2888
" Sweat	2843	" Rope Tramway	2862	" Yacht and Vessel	2888
" Treeing	2844	" Rope	2862	Salicylate of Cocaine	882
" Barn Door	2839	" Rope Wire (Copper)	2860	Saline, Fruit	2889
" Blind	2832	" Wire (Galvanized)	2860		
" Blind (Square Pine)	2837				



INDEX TO ARTICLES.

	No.	Saws,	No.	Scales,	No.
Salmon, Canned	2897	" Combination	2904	" Market	2916
Salt, Butter	2890	" Compass	2904	" Mill	2916
" Celery	2892	" Concave Circular	2911	" Ore	2916
" Cheese	2890	" Cross Cut	2909	" Platform	2916
" Coarse	2893	" Drag	2909	" Pocket	2917
" Dairy	2893	" Duplex	2911	" Precision	2917
" Family	2890	" "Emerson" Tooth	2907	" Railway Track	2916
" Land	2893	" Framed Buck	2908	" Rolling Mill	2916
" Packers'	2890	" Gang	2911	" Scoop Balance	2915
" Rock	2893	" Grooving	2911	" Silver	2917
" Table	2893	" Grooving Circular	2911	" Special Graduation	2917
" Windsor	2891	" Hack	2904	" Steel	2917
Salts, Chemical	2895	" Hand	2904	" Stock	2916
" Copper	2894	" Heading	2911	" Waggon	2917
" Glauber's	2894	" Ice	2911	" Warehouse	2916
" Iron	2894	" Inserted Tooth Circular	2904	" and Balances, Letter	2917
" Lead	2894	" Japanese	2911	Scalders, Fruit and Vegetable	
" Lithium	2894	" Jig	2910	(Canners)	2125
" Manganese	2894	" Kitchen	2911	Scalpers, Elevator	2918
" Mineral Water	2896	" "Lumber Clipper"	2907	Scarfs, Knit	1914
" Nickel	2894	" Mill	2911	Scoops, Candy	2923
" Opium	2894	" Mitre Box	2904	" Confectioners'	2923
" Purified	2894	" Movable	2911	" Copper	2923
" Silver	2894	" One Man Cross Cut	2911	" Brass	2923
" Sodium	2894	" Panel	2904	" Glass	2922
" Tartar	2894	" Pattern Makers' Dimen-	2911	" Grain	2924
" Tin	2894	sion	2911	" Grocers' Tin	2923
" Tincture	2894	" Pit	2911	" (Iron and Steel)	2924
" Zinc	2894	" Plumbers'	2904	" Root	2925
" and Peppers (Plated)	2448	" Pork Packers'	2904	" Scale	2923
Sandals, Rubber	3056	" Pruning	2904	" Steel	2924
Sanitary Ware	3687	" Pulp Mill	2911	" Sugar	2923
Sarsapilla Beverages	20	" Re-Sawing	2911	" Tanners'	2923
Sash, Doors and Blinds	2898	" Rip (Hand)	2904	" Tea	2923
" Window	2898	" Screw Gang (Stone)	2905	" Thumb	2923
Sashes, (Knit)	1854	" Scroll	2904	" Tin	2923
" Wool	2890	" Segment	2911	" Vegetable	2925
Sassafras, Oil of	2317	" Shingle	2911	" Veneer	2926
Satchels, Leather	2901	" Ship Carpenters'	2904	Scourers, Buckwheat	2920
" Letter	2901	" Slitting	2904	" Close	2920
" Medicine	2901	" "Spalding" Tooth	2907	" Corn	2920
" Musio	2900	" Steel Rail	2906	" Heel	2919
" School	2901	" Stone	2905	" Wheat	2920
Satinettes (Confectionery)	2902	" Swing Cut-off	2911	" Wool	2920
Sauce, Pepper	2903	" Timber	2911	Scows, River	2921
" Table	2903	" Turning	2911	Scrapers, Bowl	2927
" Worcester	2903	" Veneering	2911	" Box	2929
Sausage, Blood	2577	Scales, Army	2917	" Butchers'	2929
" Bologna	2577	" Automatic	2915	" Contractors'	2929
" Cambridge	2577	" Bag and Barrel (Combi-	2915	" Coopers'	2929
" Chicken	2577	nation)	2915	" Drag	2927
" Ham	2577	" Beam	2916	" Dump	2927
" Liver	2577	" Beam (Tea)	2915	" Farmers'	2927
Saw Gummers	2913	" Butchers'	2917	" Fring	2930
" Gummers, Emery Wheel	2914	" Chemists'	2917	" Flue	2929
" Mills, Band	2200	" Coal	2916	" Foot (Door)	2930
" Mills, Circular	2200	" Counter	2917	" Read	2927
" Mills, Drag	2215	" Dairy	2916	" Ship	2929
" Mills, Gang	2200	" Druggists'	2917	" Ship Deck	2929
" Mills, Log Band	2200	" Family	2916	" Steel	2927
" Mills, Portable	2215	" Farm	2916	" Stove	2928
" Mills, Rotary	2215	" Fish	2917	" Wheeled	2927
Saws, Back	2904	" Gold (Suspension)	2915	Screens, Bamboo	2936
" Band	2912	" Grain	2916	" Brass	2932
" Blind Slat	2911	" Grocers'	2917	" Case	2931
" Bolting	2911	" Hay	2916	" Clay	2931
" Box Board Cut-off	2904	" Hepper	2916	" Coal	2931
" Box Board Edging	2904	" Ice	2917	" Crusher	2934
" Butchers'	2904	" Iron	2917	" Dash (Brass)	2932
" Circular	2911			" Dash (Wire)	2934

INDEX TO ARTICLES.

Screens,	No.	Screws,	No.	Separators,	No.
" Door . . . . .	2938	" Track . . . . .	2939	" Screening . . . . .	2920
" Door (Wire) . . . . .	2934	" Traversing . . . . .	2939	" Single Receiving . . . . .	2920
" Extension . . . . .	2931	Scribblers, School . . . . .	2946	" Steam . . . . .	2971a
" Fanning Mill . . . . .	2937	Scrolls, Iron . . . . .	2948	" War-house . . . . .	2920
" Fire (Brass) . . . . .	2932	" Wood . . . . .	2947	" Wheat . . . . .	2920
" Flour Mill . . . . .	2937	Scroll-Work, Wood . . . . .	2947	" and Brush Machines	
" Fly . . . . .	2931	Scythes, Bush . . . . .	2950	(Combined) . . . . .	2920
" Folding (Bamboo) . . . . .	2936	" Grain . . . . .	2950	Sepulchres, Artificial Stone . . . . .	2974
" Folding (Brass) . . . . .	2932	" Grass . . . . .	2950	Serges, Milton . . . . .	867
" Folding (Reed) . . . . .	2936	" Lawn . . . . .	2950	Services, Communion . . . . .	2976
" Folding (Steel) . . . . .	2933	Scufflers, Corn . . . . .	2949	Sesquechloride of Iron . . . . .	1827
" Grain Cleaning . . . . .	2937	" Root . . . . .	2949	Sets, Croquet . . . . .	2975
" Gravel . . . . .	2931	Seals, Corporation . . . . .	2951	" Dessert (Plated) . . . . .	2976
" Iron . . . . .	2931	" Notarial . . . . .	2951	" Fire (Brass) . . . . .	2981
" Lime . . . . .	2934	" Society . . . . .	2951	" Fire (Iron) . . . . .	2983
" Masons . . . . .	2931	" Wax . . . . .	2951	" Fire (Open Hearth) . . . . .	2981
" Ore . . . . .	2931	Seamers, Double, Power (Metal) . . . . .	3261	" Rivet . . . . .	2980
" Paper Mill . . . . .	2935	" Roofing . . . . .	3261	" Rivet (Bifurcated, Slotted) . . . . .	2980
" Pipe Coil . . . . .	2931	Seats, Buggy . . . . .	2959	" Rivet (Bifurcated, Slotted) . . . . .	2979
" Pulp Mill . . . . .	2935	" Child's Bicycle . . . . .	645	" Saw . . . . .	2978
" Rattan . . . . .	2936	" Carriage . . . . .	2959	" Saw (Perfect) . . . . .	2977
" Reed . . . . .	2936	" Cart . . . . .	2955	" Self-Feeding (Tubular	
" Rolling . . . . .	2934	" Chair (Veneer) . . . . .	2958	Rivet) . . . . .	2979
" Sand . . . . .	2931	" Chair (Perforated		" Testing (Electrical) . . . . .	2982
" Separator . . . . .	2937	Veneer) . . . . .	2958	Settees, Bamboo . . . . .	3156
" Steel . . . . .	2931	" Church . . . . .	2960	" Folding . . . . .	772
" Threshing Machine . . . . .	2937	" Garden and Park (Iron) . . . . .	2954	" Hall . . . . .	772
" White Mortar . . . . .	2934	" Hall . . . . .	2957	" Iron . . . . .	2988
" Window . . . . .	2938	" School . . . . .	2960	" Lawn . . . . .	2988
" Window (Wire) . . . . .	2934	" School (Iron) . . . . .	2961	" Lawn (Wood) . . . . .	772
" Wire . . . . .	2934	" School (Patent Spring) . . . . .	2956	" Park . . . . .	2988
" Wire Partition . . . . .	2934	" Station . . . . .	2961	" Rattan . . . . .	3156
Screw Drivers . . . . .	2945	" Waggon . . . . .	2955	" Veneer . . . . .	772
Screws, Bed . . . . .	2942	" Wall Bracket . . . . .	2956	" Wire . . . . .	2985
" Bench (Wood) . . . . .	2940	" Water Closet . . . . .	2953	Setter, Axle . . . . .	2989
" Bench (Iron) . . . . .	2941	Seatings, Hair Cloth . . . . .	862	Shackles, Boom (Log) . . . . .	2990
" Bicycle . . . . .	2942	" Perforated . . . . .	2952	" Side Bar . . . . .	2986
" Brass . . . . .	2944	" Sunday-School . . . . .	2960	" Spring . . . . .	2986
" Bronze . . . . .	2944	" Veneer . . . . .	2952	Shades, Decorated Window . . . . .	2991
" Cap . . . . .	2942	Secretaries, Cabinet . . . . .	1155	" Electric Light (Tin) . . . . .	2993
" Carpenters' Clamp . . . . .	2946	Sections, Reaper and Mower . . . . .	2963	" Gas (Tin) . . . . .	2993
" Chair (Revolving) . . . . .	2941	Securities, Corporation (Eng.) . . . . .	1295	" Glass . . . . .	2992
" Cheese Press . . . . .	2941	" Corporation (Litho.) . . . . .	1295	" Lamp (Crimp Fancy) . . . . .	2992
" Chilled . . . . .	2941	" Corporation (Print.) . . . . .	1295	" Lamp (Glass) . . . . .	2992
" Cider Press . . . . .	2941	Sedans, Liqueur . . . . .	2018	" Lamp (Metal) . . . . .	2993
" Coach . . . . .	2944	Sedative, Palmer's Bronchial . . . . .	2965	" Window (Plain and De-	
" Collar . . . . .	2944	Seed, Flax . . . . .	2967	corated) . . . . .	2991
" Dowel . . . . .	2944	Seeds, Garden & Field . . . . .	3856	Shafts, Brush . . . . .	2119
" Felloe . . . . .	2944	Seeders, Broadcast . . . . .	2968	" Crank . . . . .	2994
" Hand (Wood) . . . . .	2940	" Combination . . . . .	2968	" Counter . . . . .	2994
" Hand Rail . . . . .	2944	" Grass . . . . .	2968	" Locomotive Rocker . . . . .	2997
" House Raising . . . . .	2939	" & Cultivators (Com.) . . . . .	1082	" Vehicle . . . . .	3889
" Iron . . . . .	2941	" & Harrows (Com.) . . . . .	2968	" Shafts and Flights, Con-	
" Jack . . . . .	2939	" & Sowers (Combined) . . . . .	2968	veyor . . . . .	2998
" Knob . . . . .	2944	Seltzer . . . . .	20	Shafting, Iron . . . . .	2994
" Lag . . . . .	2941	Semaphores . . . . .	2969	" Steel . . . . .	2994
" Locomotive . . . . .	2939	Separators, Aspirating . . . . .	2920	Shakes, Milk . . . . .	2999
" Machine . . . . .	2942	" B'wheat Refining 2 2) . . . . .	2970	Shakers, Stove . . . . .	2564
" Machine (Milled) . . . . .	2942	" Cream . . . . .	2970	Shams, Pillow . . . . .	3001
" Ornamental . . . . .	2944	" Double Receiving . . . . .	2920	Shank Machines, Shoe . . . . .	2119
" Pad (Harness) . . . . .	2943	" Dustless . . . . .	2920	Shanks, Shoe (Iron) . . . . .	3004
" Plated . . . . .	2944	" Elevator . . . . .	2920	" Shoe (Leather) . . . . .	3005
" Saw . . . . .	2944	" Grain . . . . .	2920	" Shoe (Steel) . . . . .	3004
" Set . . . . .	2942	" Gravity . . . . .	2920	" Shoe (Wood) . . . . .	3003
" Sewing Machine . . . . .	2944	" Hominy . . . . .	2920	" Step (Vehicle) . . . . .	3002
" Shear . . . . .	2944	" Hulled Oats . . . . .	2920	Shapers, Attachment (Iron) . . . . .	3006
" Skate . . . . .	2944	" Magnetic . . . . .	2920	Shapes, Bonnet and Hat . . . . .	1683
" Skein . . . . .	2944	" Milling . . . . .	2920	Sharpeners, Emery Saw	
" Stool (Office) . . . . .	2941	" Ore . . . . .	2920	(Roger's) . . . . .	3010
" Stool (Piano) . . . . .	2941	" Potato (Hand) . . . . .	2971		

INDEX TO ARTICLES.

	No.		No.		No.
Sharpeners,		Shields, Dress.	3038	Shovels,	
“ Emery Saw		“ Nipple (Rubber)	3037	“ Iron	2924
“ (Tolman's)	3019	“ Spun Metal	3039	“ Lime	3063
“ Mower and Reaper		“ & Tips, Finger (Rubber)	3037	“ Locomotive	2924
“ Knife	3008	Shingles, Galvanized Iron	3042	“ Malt	3063
“ Saw (Automatic)	3009	“ Metallic, “Eastlake's		“ Mining	3063
“ Scythe	3011	“ Patent	3042	“ Railroad	3063
Shaves, Barrel	3012	“ Shaved (Hand-Made)	3040	“ Round Point	2924
“ Coopers'	3012	“ Steel, “Walter's Pat.”	3042	“ Sawdust	3063
“ Heel	2119	“ Steel	3041	“ Seaside Toy	3061
“ Spoke	3012	Ships, Steam	3259	“ Snow (Steel)	3063
“ Waggon Makers'	3012	“ Steel and Iron	3043	“ Snow (Wood)	3065
Shavings, Cork	3013	Shirts, Balbriggan	3046	“ Square Point	3063
Shawls, Lap	3015	“ Colored (Cotton)	3047	“ Steam	3062
“ Wool	3014	“ Cotton	3047	“ Steel	2924
Shears, Alligator	3022	“ Embroidered	3047	“ Steel Firing	3063
“ Bench	3016	“ Fire	3047	“ Tamping	3063
“ Circular	3016	“ Flannel	3047	“ Veneer	3065
“ Inside Cutting	3016	“ Knit	3046	Shrinkers, Tire	3066
“ Lever	3016	“ Knit, Top	3045	Shuckers, Buckwheat	3067
“ Lever and Pouch	3016	“ Laundry and Un-		Shunts, Galvanometer	3068
“ Metal Workers' (Hand)	3016	“ laundried	3047	Shutters, Fire Proof, Window	3070
“ Metal Workers' (Power)	3022	“ Linen	3047	“ (Iron) Rolling	3071
“ Power	3022	“ Men's	3047	“ Window	3069
“ Saw (Power)	3022	“ Night (Cotton)	3047	“ Wood	3069
“ Sheet Metal	3022	“ Outing	3047	Shuttles, Carpet	3072
“ Slitting	3016	“ White	3047	“ Cotton	3072
“ Squaring	3016	Shirting, Cotton	3044	“ Sewing Machine	3073
“ Squaring (Gap)	3016	“ Drill	3044	“ Woolen Mill	3072
Sheathing, Asbestos	3019	“ Gingham	3044	Sickles, Hand	2950
“ Felt (Chemical)	2857	Shoddy	3281	“ Reaper	2950
“ Paper	3018	Shoes and Boots, Leather	394	SideBoards, Dining Room	1506
“ Straw	3017	Shoes, Athletic	3052	Siding, Car	3075
“ Plain (Paper)	3018	“ Bathing	3052	“ Elevator	3076
“ Tarred	3018	“ Brake (Car)	3051	“ Metallic (Corrugated)	3076
“ Waterproof	3018	“ Brake (Iron)	3051	“ Sheet Steel	3076
“ Wood	3075	“ Canvas	3052	Siennas, Burnt	3077
Sheaves, Block	3023	“ Cork Sole	3052	“ Raw	3077
“ Chain	3023	“ Crushing (Ore)	3051	Sieves, Ash	3078
“ Chain	3023	“ Felt	3053	“ Coal	3078
“ Door (Sliding)	3020	“ Fox (Leather)	3053	“ Druggists'	3078
“ Lignum Vitae	3021	“ Felt Lined	3053	“ Flour	3078
“ Hawsing	3021	“ Gymnasium	3052	“ Wire	3078
“ Rope	3023	“ Horse	3057	Sifters, Flour	3080
“ Wire Rope	3023	“ Hunting	3052	“ Lozenge	3079
Sheepskins	3077	“ Iron (Chilled)	3051	Signs Brass	3085
Sheeting, Nursery	3024	“ Lumbermen's (Rubber)	3056	“ Advertising	3084
“ Hospital	3024	“ Miners'	302	“ Glass	3086
“ Rubber	3024	“ Over (Rubber)	3056	“ Gold Lettered	3083
Sheetings, Cotton	3026	“ Patent Leather	3052	“ Illuminated	3084
“ Twill	3026	“ Picking (Loom)	3049	“ Silver Lettered	3083
“ Woolen	3025	“ Rubber	3056	“ Wire	3087
Shells, Push Button (Brass)	3031	“ Sleigh	3050	Signals, Automatic, Street	3081
“ Push Button (Copper)	3031	“ Snow	1354	“ Automatic Block	3081
“ Leaded (Paper)	3030	“ Steel (Chromo)	3051	“ Block	3081
“ Shot (Brass)	3030	“ Tennis (Rubber)	3056	“ Crossing	3081
“ Shot (Paper)	3030	Shooks, Box	3059	“ Interlocking	3081
“ Telephone (Rubber)	3029	“ Crate	3059	“ Mechanical Block	3081
Shellacs	3027	“ Knockdown	3059	“ Mine (Electric)	3082
Shellers, Corn	3028	“ veneer (Knockdown)	3058	“ Railway	3081
Shellers and Cleaners, Corn	3028	Shorts, Millfeed	1439	“ Railway Junction	3081
Shelves, Book (Bamboo)	3032	Shot, Buck	3060	“ Switch	3081
“ Slate	3034	“ Chilled	3060	Silks, Broad	3088
“ Veneer (Basket)	3033	Shoulders, Pork	2576	“ Brocaded	3088
“ Veneer (Crate)	3033	“ New York Cut	2576	“ Crocheting	3088
Shelving, Book	3036	“ Square Cut	2576	“ Dress	3088
“ Combard	3036	Shovels, Coal	2924	“ Embroidery	3088
“ Office	3036	“ Drain	3063	“ Etching	3088
“ Slate	3034	“ Fire (Iron and Brass)	2981	“ Fancy	3088
“ Slate (Dairy)	3034	“ Grain	2924	“ Filling	3088
Sherry, Native	3790				

INDEX TO ARTICLES.

Silks,	No.	Slate,	No.	Sockets, Bow (Carriage Top)...	No.
" Floss .....	3088	" Roofing .....	3115	" Colter .....	3152
" Gros Grain .....	3088	Slates, Roofing .....	3115	" Drill .....	3149
" Knitting .....	3088	" School .....	3115	" Electric Lamp .....	3150
" Lining .....	3088	Slatewrik, Sanitary .....	3117	" Pole (Carriage) .....	3146
" Organzine .....	3088	Slating, Liquid .....	3118	" Row Lock .....	3147
" Outline .....	3088	Sleds, Bob .....	3122	" Shaft .....	3146
" Printed .....	3088	" Children's .....	3122	" Whip .....	3148
" Raw .....	3088	" Coasting .....	3120	Socks, Felt .....	3153
" Rope .....	3088	Sledges, Blacksmiths' .....	1644	" Lumberman's Tufted .....	3153
" Spool .....	3088	" Coal .....	1644	Soda, Cream .....	20
" Spun .....	3088	" Farriers' .....	1644	" Sulphate of .....	3155
" Surah .....	3088	" Horseshoe-Turning .....	1644	Sodium Acetate .....	1
" Thread .....	3088	" Quarry .....	1644	" Arseniate .....	54
" Thrown .....	3088	" Railroad .....	1644	" Benzoate .....	3155
" Tram .....	3088	" Steel .....	1644	" Bromide .....	3165
" Tram .....	3088	" Steel Face .....	1644	" Chloride .....	798
" Upholstery .....	3088	" Stone .....	1644	" Iodide .....	1817
" Wash .....	3088	Sleeves, Rubber .....	3121	" Nitrate .....	3155
Sills, Door (Slate) .....	3115	Sleighs, Bob .....	3123	" Oxalate .....	3155
" Door and Window (Iron) .....	2013	" Children's .....	3122	" Salicylate .....	3155
" Door and Window (Stone) .....	2012	" Hand .....	3122	" Salts .....	3155
Silverware, Antique .....	3091	" One and Two Horse .....	3123	" Sulphate .....	3155
" Flat .....	3092	" Pony .....	3123	" Sulphite .....	3155
" Hollow .....	3092	Slicers, Bread and Cake .....	3126	Sofas, Bamboo .....	3156
" Hotel .....	3092	" Fruit .....	3126	" Rattan .....	3156
" Plated .....	3092	" Ham .....	3126	" Upholstered .....	1506
" Sterling .....	3091	" Meat .....	3126	Solder, Block .....	3158
Singletrees, Horse .....	3675	" Root .....	3124	" Drop .....	3158
Sinks, Copper .....	3096	" Vegetable .....	3125	" Gold .....	2805
" Enamelled .....	3094	" Vegetable (Household) .....	3125	" Lead .....	3158
" Galvanized .....	3094	Slides, Breast Strap Harness .....	3127	" Plate .....	3158
" Iron and Steel .....	3097	Slings, Combined Hay and Grain .....	3128	" Plumbers' .....	3158
" Japanned .....	3094	Slippers, Carpet .....	3129	" Silver .....	2805
" Kitchen .....	3093	" Felt Lined .....	3129	" Spelter .....	3158
" Pantry .....	3093	" Leather .....	3129	" Strip .....	3158
" Porcelain .....	3093	Smelters, Copper .....	3130	" Wire .....	3158
" Sectional ("Demarest") .....	3094	" Ore .....	3130	Soles, Cork (Shoe) .....	3159
" Sectional ("Magee") .....	3094	Smokers, Bee .....	3131	Soling, Rubber .....	3160
" Slate .....	3115	Snap, Box .....	1751	Solution, Amalgamating .....	3161
" Stable .....	3095	" Eye .....	1751	" Camphor .....	3162
Siphons, Metal .....	3098	" Harness .....	1751	" Gold .....	3161
Size, Dry ("Church's") .....	3099	" Swivel .....	1751	" Plating .....	3161
" Gild .....	1860	Snaths, Scythe .....	3132	Solutions, Chemical .....	3161
" Painters' .....	3100	Snuff, Black .....	3134	" Medicinal .....	3161
Sizers, Ore .....	3101	" Catarrh .....	3133	Sounders, Telegraph .....	3163
Shakes, Ice .....	3102	" Macaboy .....	3134	Sour, Lemon .....	20
Skeins, Thimble .....	3103	Soap, Antiseptic (Johnston's Ethereal) .....	3145	Sowers, Broadcast .....	3164
" Waggou .....	3103	" "Baby's Own" .....	3140	" Drill .....	3164
Skewers, Butchers' .....	3104	" Castile .....	3140	" Double Drill Seed .....	3164
" Cettin Mill .....	3105	" Carbolic .....	3140	" Seed .....	3164
Skiffs, Fishing .....	3106	" Century .....	3138	" Seed (Hand) .....	3164
" Racing .....	3106	" Cotton Seed Oil .....	3137	Spades, Butter .....	3165
" Rowing .....	3106	" Electric .....	3143	" Ditching .....	2924
" Sailing .....	3106	" Fulling .....	3143	" Ice .....	2924
Skillets, Match (Veneer) .....	3107	" Dog ("Harry Lewis's") .....	3140	Spars, Ship .....	3166
Skips, Cial .....	3110	" Laundry .....	3143	" Ship (Steel and Iron) .....	3167
Skins, Dressed .....	3109	" Medicinal .....	3140	SSpecials, Water Works .....	3168
" Raw .....	3109	" Oatmeal .....	3135	Specialties, Druggists' .....	3169
Skivers, Leather .....	3111	" Queen's .....	3140	Speculum, Rubber .....	2869
" Bookbinders' .....	3112	" Soft Oil .....	3136	Spelter, Hard .....	3171
Skylights, Metallic .....	3113	" Sulphur .....	3140	" Soft .....	3171
Slabs, Curriers .....	3115	" Tar .....	3140	" Zinc .....	3171
" Mantel (Slate) .....	3115	" ("The Master Me- chanic's") .....	3140	Spices, Ground .....	3172
" Marble .....	3114	" Toilet .....	3141	" Powdered .....	3172
" Plumbers' (Marble) .....	3114	" Vaseline .....	3139	Spiders, Cooking (Steel) .....	3173
" Plumbers' (Slate) .....	3115	" Whale Oil .....	3140	Spikes, Boat .....	3174
" Stone .....	3114	Soapstone .....	55	" Cut .....	3174
Slashers, Slab .....	3116			" Iron .....	3174
Slate, Building .....	3115			" Railroad .....	3174
" Builders' .....	3115				

INDEX TO ARTICLES.

Spikes,	No.	Springs,	No.	Stands,	No.
“ Reverse Point. . . . .	3174	“ Machinery (All kinds). . . . .	3203	“ Bee Hive. . . . .	3246
“ Ship. . . . .	3174	“ Piston. . . . .	2820	“ Biscuit. . . . .	3239
“ Steel. . . . .	3174	“ Rubber. . . . .	3202	“ Boiler. . . . .	3234
“ Sidewalk. . . . .	3174	“ Rubber (Car). . . . .	3202	“ Boiler (Hot Water). . . . .	3234
“ Track. . . . .	3174	“ Rubber (Waggon). . . . .	3208	“ Boiler (Range). . . . .	3234
“ Vessel. . . . .	3174	“ Sofa. . . . .	3200	“ Copying Press. . . . .	3243
“ Wharf. . . . .	3174	“ Special. . . . .	3199	“ Emery Grinder. . . . .	3232
Spindles, Saw. . . . .	3176	“ Spiral. . . . .	3201	“ Fire (Iron). . . . .	3245
Spiles, Liquid. . . . .	3175	“ Spiral (Car). . . . .	3201	“ Flower Pot (Wire). . . . .	3240
“ Tap. . . . .	3175	“ Spiral (Locomotive). . . . .	3201	“ Foot (Brass). . . . .	3235
“ Vent. . . . .	3175	“ Steel. . . . .	3202	“ Hall. . . . .	3239
Spirit, Cologne. . . . .	3177	“ Steel (Car). . . . .	3201	“ Hat Rack. . . . .	3239
“ Medicinal. . . . .	3177	“ Suspender. . . . .	3205	“ Ink (Iron). . . . .	3241
Spirits, Tin. . . . .	3176a	“ Tempered. . . . .	3202	“ Ink (Glass). . . . .	3242
Spittoons, Brass. . . . .	3181	“ Umbrella. . . . .	3205	“ Music. . . . .	3239
“ Fibre. . . . .	3186	“ (Vehicle). . . . .	3202	“ Music and Book. . . . .	3239
“ Iron. . . . .	3182	“ Waggon. . . . .	3202	“ Sad Iron. . . . .	3245
“ Nickle. . . . .	3181	“ Waggon Seat. . . . .	3202	“ Sewing Machine. . . . .	3230
“ Rubber. . . . .	3178	“ Window and Door. . . . .	3204	“ Switch. . . . .	3231
“ Rockingham Ware. . . . .	3179	Sprinklers, Automatic. . . . .	3210	“ Tea and Coffee Pot. . . . .	3245
“ Stoneware. . . . .	3180	“ Garden and Lawn. . . . .	3211	“ Tub. . . . .	3244
Splints, Match. . . . .	3184	“ Hand. . . . .	3210	“ Umbrella (Art Stone). . . . .	3237
“ Surgical. . . . .	3183	“ Hose. . . . .	3211	“ Umbrella (Bamboo and	
Splitters, Leather. . . . .	3186	“ Street (Wood & Steel		“ Rattan). . . . .	3239
“ Wood. . . . .	3185	“ Tank). . . . .	3209	“ Umbrella (Brass). . . . .	3235
Spokes, Waggon. . . . .	3187	“ Suction. . . . .	3211	“ Umbrella (Clay). . . . .	3236
“ Wheel. . . . .	3187	Squares, Art. . . . .	640	“ Umbrella (Iron). . . . .	3238
“ Wood. . . . .	3187	“ Carpet. . . . .	640	“ Umbrella (Wire). . . . .	3240
Spools, Cotten and Woolen Mill. . . . .	3190	“ Trace (Wrought Iron). . . . .	3214	“ Wash (Adjustable). . . . .	3233
“ Rope. . . . .	3190	Squeezers, Lemon (Glass). . . . .	3212	“ Work (Bamboo). . . . .	3239
“ Silk. . . . .	3189	“ Lemon (Metal). . . . .	3213	“ Work (Rattan). . . . .	3239
“ Thread. . . . .	3189	Squillees, Rubber. . . . .	3029	“ Wringer. . . . .	3244
“ Wire. . . . .	3190	Stable Fittings (Iron). . . . .	1831	Standards, Electric. . . . .	3228
“ Wire (Electric). . . . .	3190	Stacks, Smoke (Boiler Plate). . . . .	3216	“ Lamp (Gas). . . . .	3228
Spoolers, Bobbin. . . . .	3188	Stackers, Straw (Pneumatic). . . . .	3215	Staples, Barbed. . . . .	3249
“ Drum. . . . .	3188	Stains, Cherry. . . . .	3217	“ Blind. . . . .	3248
“ Wool. . . . .	3188	“ Leather Board. . . . .	3217	“ Fence. . . . .	3249
“ Worsted. . . . .	3188	“ Mortar. . . . .	3217	“ Hooks and. . . . .	1758
Spoolwood. . . . .	3191	“ Mahogany. . . . .	3217	“ Steel. . . . .	3248
Spoolwood, Prepared. . . . .	3189	“ Paper. . . . .	3217	“ Tail-board. . . . .	3248
Spoons, Basting. . . . .		“ Shingle. . . . .	3217	“ Waggon Box. . . . .	3248
“ Kitchen. . . . .		“ Walnut. . . . .	3217	“ Wire. . . . .	3249
“ Plated. . . . .	3092	“ Water. . . . .	3217	“ Wrought. . . . .	3248
“ Post Hole. . . . .	3193	“ Wood. . . . .	3217	“ and Hasps. . . . .	1721
“ Sterling Silver. . . . .	3092	Stairs, Iron. . . . .	3219	Starch, Corn. . . . .	3251
“ Tin. . . . .		“ Slate. . . . .	3220	“ Laundry. . . . .	3250
Spouts, Iron Pump. . . . .	3194	“ Spiral. . . . .	3219	“ Potato. . . . .	3250
“ Sap. . . . .	3194	“ Steel. . . . .	3218	“ Rice. . . . .	3251
Spreads, Bed. . . . .	1015	“ Wood. . . . .	3221	“ Wheat. . . . .	3251
Springs, Bed. . . . .	3200	Staircases, Iron Spiral. . . . .	1832	Stationery, Commercial. . . . .	3252
“ Bed (Knockdown). . . . .	3197	Stakes, Timmers'. . . . .	3222	Statuary, Granite. . . . .	3253
“ Bicycle. . . . .	3206	Stalks, Whip. . . . .	3223	“ Marble (Italian). . . . .	3253
“ Cage (Bird). . . . .	3196	Stalls, Stable (Box). . . . .	3224	Staves, Barrel. . . . .	3255
“ Car (Freight). . . . .	3201	Stamps, Autograph. . . . .	3226	“ Nail Keg. . . . .	3254
“ Car (Passenger). . . . .	3201	“ Bookbinders'. . . . .	3227	Stays, Coil. . . . .	3258
“ Car Seat. . . . .	3200	“ Brass. . . . .	3227	“ Door (Barn). . . . .	3258
“ Carriage. . . . .	3202	“ Butter. . . . .	3225	“ Dress. . . . .	3256
“ Chair. . . . .	3200	“ Dating. . . . .	3226	“ Dress “ Ever Ready ”. . . . .	3257
“ Clip. . . . .	3201	“ Numbering. . . . .	3226	“ Smoke Stack. . . . .	3258
“ Coach (Railway). . . . .	3201	“ Office. . . . .	3226	Steamboats. . . . .	326
“ Coil. . . . .	3201	“ Pencil. . . . .	3226	Steamers, Bread and Vegetable. . . . .	3260
“ Cushion. . . . .	3200	“ Pocket. . . . .	3226	“ Lake. . . . .	3259
“ Cushion (Church). . . . .	3200	“ Post Office. . . . .	3226	“ Ocean. . . . .	3259
“ Elliptic. . . . .	3201	“ Railroad. . . . .	3226	“ Passenger. . . . .	3259
“ Furniture. . . . .	3200	“ Rubber. . . . .	3226	“ River. . . . .	3259
“ Gaiter. . . . .	3195	“ Self-Inking. . . . .	3226	Steamships, Iron and Steel. . . . .	3259
“ Glove, “ Storeys’		“ Steel. . . . .	3227	Steel, Agricultural. . . . .	3265
“ Eureka ”. . . . .	3207	Stands, Bamboo and Rattan. . . . .	3239	“ Bar. . . . .	3265
“ Harrow. . . . .	3198	“ Basket (Wire). . . . .	3240	“ Channel (Bridge). . . . .	3263
“ Locomotive. . . . .	3201	“ Bicycle (Safety). . . . .	3247	“ Corrugated (Sheet). . . . .	3264



INDEX TO ARTICLES.

	No.		No.		No.
Steel,		Stones,		Straps,	
“ Hammered . . . . .	3265	“ Tomb . . . . .	2235	“ Street Car Bell (Brass)	3320
“ Harrow Frame . . . . .	3262	“ Wood Pulp . . . . .	3293	“ Tourists . . . . .	1669
“ Machinery . . . . .	3265	Stoneware, Chemical . . . . .	3289	“ Trunk . . . . .	1669
“ Merchant . . . . .	3265	“ Salt Glazed . . . . .	3290	Strawberries, Canned . . . . .	611
“ Open Hearth . . . . .	3265	Stools, Camp . . . . .	769	Stretchers, Artists' . . . . .	3331
“ Rolled . . . . .	3265	“ Counter . . . . .	3296	“ Belt . . . . .	3332
“ Soft . . . . .	3265	“ Fancy . . . . .	3299	“ Carpet (Megg's Pat.)	3329
“ Spring . . . . .	3265	“ Folding (Camp) . . . . .	769	“ Cloth . . . . .	3328
“ Structural . . . . .	3265	“ Foot . . . . .	772	“ Saw . . . . .	3327
“ Tire . . . . .	3265	“ Office . . . . .	772	“ Shoe . . . . .	2119
“ Toe-Calk . . . . .	3265	“ Office (Revolving) . . . . .	772	“ Wire . . . . .	3330
Steels, Butcher . . . . .	3266	“ Organ . . . . .	3301	Strips, Weather, Rubber . . . . .	2164
“ Butchers' Emery . . . . .	3266	“ Parlour . . . . .	3299	Strops, Razor . . . . .	3333
“ Capping . . . . .	3266a	“ Piano . . . . .	3301	Structural, Iron and Steel . . . . .	1552
“ “ Carver's Friend”		“ Piano (Brass) . . . . .	3302	Studs, Brass . . . . .	3335
“ (Emery) . . . . .	3266	“ Store (Iron) . . . . .	3300	“ Iron . . . . .	3334
“ Corset (Covered) . . . . .	3267	“ Store (Revolving) . . . . .	3300	“ Rolled Gold . . . . .	3336
“ Corset (Japanned) . . . . .	3267	Stops, Bench . . . . .	3307	“ Shoe . . . . .	3335
“ Dress . . . . .	3267	“ Corporation . . . . .	3310	Stuffers, Sausage . . . . .	3337
“ Household (Emery) . . . . .	3266	“ Door (Barn) . . . . .	3307	Sublimate, Corrosive . . . . .	29
Steelyards . . . . .	3268	“ Door (Wood) . . . . .	3309	Substructure, Monolithic . . . . .	3352
Steeppers, Tea . . . . .	3260	“ Sliding Door (Iron) . . . . .	3307	Succotash, Canned . . . . .	611
Stencils and Stamps (Metal) . . . . .	3269	“ Sliding Door (Wood) . . . . .	3309	Sugar, Cane . . . . .	3339
Steps, Cutter . . . . .	3271	“ Steam . . . . .	3310	“ Beet . . . . .	3340
“ Carriage (Forged) . . . . .	3271	“ Water Works (Rough) . . . . .	3308	“ Granulated . . . . .	3339
“ Slate . . . . .	3115	Stoppers, Bottle . . . . .	3304	“ Loaf . . . . .	3339
“ Sleigh (Forged) . . . . .	3271	“ Bottle (Glass) . . . . .	3303	“ Lump . . . . .	3339
“ Street Car . . . . .	3271	“ Flue . . . . .	3305	“ Pulverized . . . . .	3339
“ Stone . . . . .	2012	Stopples, Rubber . . . . .	3306	“ Maple . . . . .	3338
“ Vehicle (Malleable Iron) . . . . .	3270	Stout, Ale and Porter . . . . .	19	Suites, Parlour (Matted) . . . . .	3344
Stereotypes . . . . .	1259	Stoves, Camp (Sheet Iron) . . . . .	3313	Suits, Chamber . . . . .	1506
Stethoscopes . . . . .	3272	“ Car . . . . .	3316	“ Men's . . . . .	873
Sticks, Hockey . . . . .	3275	“ Coal . . . . .	3316	“ Parlour . . . . .	1506
“ Lacrosse . . . . .	3273	“ Cooking . . . . .	3316	Suitings, Woolen . . . . .	3341
“ Picker (Woolen Mill) . . . . .	3276	“ Dairy . . . . .	3316	“ Worsted . . . . .	3341
“ Walking . . . . .	3274	“ Farmers' Box . . . . .	3316	Sulkies, Boys' . . . . .	3345
Stiffenings, Boot and Shoe . . . . .	3277	“ Gas (Iron) . . . . .	3314	“ Dog and Goat . . . . .	3345
Stills, Brewers' Copper . . . . .	3278	“ Heating . . . . .	3316	“ Trotting (Pneumatic	
Stirrers, Curd (Cheese) . . . . .	3279	“ Hot Blast . . . . .	3316	“ Tyre) . . . . .	3346
Stirrups, Iron . . . . .	1751	“ Laundry . . . . .	3316	Sulphate of Ammonia . . . . .	29
Stock, Felt . . . . .	3281	“ Oil (Iron) . . . . .	3314	“ of Copper . . . . .	3347
“ Nursery . . . . .	3280	“ Open Grate . . . . .	3312	“ of Iron . . . . .	1827
“ Wool . . . . .	3281	“ Parlor . . . . .	3316	“ of Lead . . . . .	1952
“ and Dies, Pipe . . . . .	3282	“ Special Brands . . . . .	3315	“ of Potassium . . . . .	2584
“ and Dies (Blacksmiths') . . . . .	3282	“ Toy . . . . .	3311	“ of Sodium . . . . .	3347
Stockings, Cashmere . . . . .	1772	“ Wood . . . . .	3316	“ of Zinc . . . . .	1827
“ Lumbermen's . . . . .	3154	Straighteners, Axle . . . . .	3336a	“ of Iron . . . . .	1827
Stokers, Automatic . . . . .	3283	Strainers, Conductor . . . . .	3325	Sulphite of Ammonia . . . . .	29
“ Mechanical . . . . .	3283	“ Cup . . . . .	3317	Sulphur . . . . .	3348
Stone, Abutment . . . . .	3288	“ Faucet (Brass) . . . . .	3318	Sulphuret of Potassium . . . . .	2584
“ Artificial . . . . .	3288	“ Faucet (Iron) . . . . .	3325	Sulphuric Ether . . . . .	1325
“ Building . . . . .	3288	“ Foot Valves and . . . . .	3623	Sunshades . . . . .	3355
“ Culvert . . . . .	3288	“ Gravy . . . . .	3317	Supports, Sash (Window) . . . . .	3349
“ Cut . . . . .	2235	“ Milk . . . . .	3317	Supplies, Electrical . . . . .	3354a
“ Dimension . . . . .	3288	“ Tea and Coffee . . . . .	3317	Supporters, Abdominal . . . . .	3358
“ Foundation . . . . .	3288	“ Water Pipe . . . . .	3325	“ Elastic . . . . .	3357
“ Lime . . . . .	3284	“ Wire . . . . .	3317	“ Garment . . . . .	3357
“ Quarry . . . . .	3288	Strand (For Terra Cotta Work) . . . . .	3319	“ Skirt . . . . .	3357
“ Monumental . . . . .	3285	Straps, Block . . . . .	3323	“ Sleeve . . . . .	3357
“ Railway . . . . .	3288	“ Box . . . . .	1669	“ Spinal . . . . .	3358
“ Riprap . . . . .	3286	“ Carriage Curtain . . . . .	3321	“ Stocking . . . . .	3357
“ Rubble . . . . .	3288	“ Deckle . . . . .	3324	“ Shaft . . . . .	3356
“ Sawn . . . . .	2235	“ Harness (Leather) . . . . .	1669	“ Thill . . . . .	3356
Stones, Curling . . . . .	3291	“ Harness (Textile) . . . . .	3226	Suppositories, Glycerine . . . . .	3350
“ Emery Rub . . . . .	3292	“ Leather . . . . .	1669	Surcingles . . . . .	1554
“ Emery Oil . . . . .	3292	“ Loom . . . . .	3326	Surfacers, Emery . . . . .	3351
“ Head (Slate) . . . . .	1702	“ Pipe . . . . .	3322	Surreys (Carriages) . . . . .	646
“ Imposing . . . . .	3295	“ Shawl . . . . .	1669	Suspenders, “ Chester ” . . . . .	3360
“ Mill (Burr) . . . . .	2217	“ Shoulder, Satchel . . . . .	1669	“ Elastic . . . . .	3361
“ Scythe . . . . .	3294	“ Skate . . . . .	1669	“ Non-Elastic . . . . .	3361

INDEX TO ARTICLES.

Suspenders,	No.	Tables,	No.	Tacks,	No.
" "Excelsior" . . . . .	3359	" Board Room . . . . .	1155	" Shoe . . . . .	3410
" "Workers" . . . . .	3360	" Brass . . . . .	3392	" Upholstery . . . . .	3410
Swages, Automatic (Saw) . . . . .	3362	" Camp (Folding) . . . . .	3387	" Wire . . . . .	3409
" Hand (Saw) . . . . .	3362	" Centre . . . . .	1506	Tackle, Chain Hoisting . . . . .	3408
" Power (Saw) . . . . .	3362	" Copper . . . . .	3395	Tags, Cattle (Brass and Nickel) . . . . .	786
" Saw . . . . .	3362	" Cut-Up (Automatic) . . . . .	3390	" Dog . . . . .	786
Sweaters, Sportsmen's Woolen . . . . .	3363	Tables, Drawing . . . . .	1155	" Shipping . . . . .	3411
Swedge, Callender . . . . .	3364	" Dressing . . . . .	1506	" Tallow . . . . .	3413
" Creasing . . . . .	3364	" Drop Leaf . . . . .	1506	Tanks, Asphalt (on Wheels) . . . . .	3419
" Elbow . . . . .	3364	" Enamelled . . . . .	3393	" Brewers' (Copper) . . . . .	3416
" Square Pan . . . . .	3364	" Extension . . . . .	1506	" Bridge . . . . .	3415
Swedges, Blacksmiths' . . . . .	3365	" Folding . . . . .	1506	" Boiler Plate . . . . .	3417
" Button . . . . .	3365	" Hall . . . . .	1155	" Cast Iron . . . . .	3414
" Top . . . . .	3365	" Kitchen . . . . .	1506	" Cistern . . . . .	3417
Sweepers, Carpet . . . . .	3367	" Library . . . . .	1155	" Factory . . . . .	3415
" Rotary . . . . .	3366	" Locomotive (Turn) . . . . .	3386	" Lard . . . . .	3417
" Snow . . . . .	3366	" Lodge Room . . . . .	1155	" Marine . . . . .	3417
" Street . . . . .	3366	" Mine Car . . . . .	3386	" Oil (Grocers') . . . . .	3418
" Track (Railway) . . . . .	3366	" Multiplication . . . . .	3397	" Oil (Railway) . . . . .	3417
Swings, Automatic . . . . .	3342	" Office . . . . .	1155	" Railroad . . . . .	3415
" Lawn . . . . .	3342	" Pigeon Hole . . . . .	3389	" Sorghum . . . . .	3417
Switches, Automatic . . . . .	3371	" Pool . . . . .	3384	" Steam . . . . .	3417
" Battery . . . . .	3370	" Portable (Turn) . . . . .	3386	" Steam Rendering . . . . .	3417
" Cut Out . . . . .	3370	" Railway (Turn) . . . . .	3386	" Tin . . . . .	3418
" Electric . . . . .	3370	" Rattan . . . . .	3239	" Water (Boiler Plate) . . . . .	3417
" Hair . . . . .	3368	" Reed . . . . .	3239	" Water (Cast Iron) . . . . .	3414
" Interlocking . . . . .	3371	" Reed . . . . .	3239	" Water (Copper) . . . . .	3416
" Jack Knife . . . . .	3370	" Saw Brazing . . . . .	3398	" Water (Wood) . . . . .	3415
" Mine Track . . . . .	3371	" School . . . . .	1155	" Water Closet . . . . .	3414
" Motor . . . . .	3370	" Side . . . . .	1506	" Windmill . . . . .	3415
" Over Head Track . . . . .	3369	" Steam (Hotel and Res-		" Wood . . . . .	3415
" Packing House . . . . .	3369	taurant) . . . . .	3395	Tanners' Bait . . . . .	120
" Portable . . . . .	3371	" Steel (Turn) . . . . .	3386	Tankards, Drinking (Silver and	
" Railway (Ramapo		" Surveyors' . . . . .	1155	Plated) . . . . .	3420
Patent) . . . . .	3372	" Tramway (Turn) . . . . .	3386	Tape, Electric Rubber . . . . .	3422
" Railway Track . . . . .	3371	" White . . . . .	3393	Tapes, Cotton . . . . .	3424
" Signalling . . . . .	3371	" Wicker . . . . .	3388	" Shirt . . . . .	3424
" Snap . . . . .	3370	" Work . . . . .	3391	" Skirt . . . . .	3424
" Spring . . . . .	3371	Tablets, Antiseptic . . . . .	3405	Tapers, Wax . . . . .	3423
" Split . . . . .	3371	" Brass . . . . .	3406	Taps, Ale . . . . .	3427
" Telegraph . . . . .	3370	" Compressed . . . . .	3401	" Blacksmiths' . . . . .	3430
" Telephone . . . . .	3370	" Cough . . . . .	3403	" Boiler Makers' . . . . .	3429
Switching Ropes, Locomotive . . . . .	2862	" Digestive . . . . .	3405	" Drill . . . . .	3430
Swivels, Iron . . . . .	3373	" Duirnal . . . . .	3405	" Expansion . . . . .	3429
" Jewelry . . . . .	3374	" Duirnules . . . . .	3405	" Machine . . . . .	3429
" Steel . . . . .	3373	" Fruit . . . . .	3402	" Pipe . . . . .	3425
Syringes, Bulb . . . . .	3378	" Hypodermic . . . . .	3405	" Shoe . . . . .	3426
" Eye and Ear . . . . .	3377	" Lithia Compressed . . . . .	3405	" Stay Bolt . . . . .	3430
" Fountain . . . . .	3377	" Marble . . . . .	3400	" Taper . . . . .	3429
" Garden (Brass) . . . . .	3375	" Medicinal . . . . .	3401	" Wood . . . . .	3175
" Glass . . . . .	3376	" Memorandum . . . . .	3407	" and Dies . . . . .	3429
" Hypodermic . . . . .	3377	" Nasal . . . . .	3405	Tar, Wood . . . . .	3432
" Hypodermic and Alu-		" Ophthalmic . . . . .	3405	Tarpaulins, Oiled Duck . . . . .	3433
minum Case . . . . .	1811	" Pepsin . . . . .	3405	" Rubber . . . . .	3434
" Indispensable Cup . . . . .	1811	" Pepsin Antiseptic . . . . .	3405	Tartar, Cream . . . . .	3435
" Utero Vaginal . . . . .	1811	" Peptonizing Imp. . . . .	3405	" Emetic . . . . .	3436
Syrup, Cane . . . . .	3339	" Quinine Compressed . . . . .	3405	Tassels, Carriage . . . . .	3437
" Glucose . . . . .	3379	" Slate . . . . .	3399	" Silk . . . . .	3437
" Iron Chloride (" Welds") . . . . .	3384	" Tritorate . . . . .	3405	Tedders, Hay . . . . .	3412
" Maple . . . . .	3380	" Urinary Test . . . . .	3405	Tees, (Pipe) Branch . . . . .	3438
" Surghum . . . . .	3381	" Veterinary . . . . .	3405	" (Pipe) Steel . . . . .	3438
" Trifolium Compound . . . . .	3384	" Writing . . . . .	2364	" (Pipe) Suction . . . . .	3438
" Yerba Santa Aromat . . . . .	3384	Tacks, Basket . . . . .	3410	Teeth, Steel Cultivator . . . . .	3441
Syrups, Cough . . . . .	3385	" Carpet . . . . .	3410	" Farm Implement . . . . .	3441
" Fruit . . . . .	3382	" Carpet (Leathered) . . . . .	3410	" Harrow . . . . .	3441
" Medicinal . . . . .	3383	" Carriage . . . . .	3410	" Steel Hay Rake . . . . .	3441
Tables, Architects' . . . . .	1155	" Cheese Box . . . . .	3410	" Wood Hand Rake . . . . .	3439
" Bamboo . . . . .	3239	" Copper and Brass . . . . .	3409	" Threshing Machine . . . . .	3440
" Billiard . . . . .	3389	" Gimp and Lace . . . . .	3410	Tees, Suction . . . . .	3438
" Billiard (Parlour) . . . . .	3389	" Miners' . . . . .	3410	Telegraphs, Ship . . . . .	3443

INDEX TO ARTICLES.

	No.		No.		No.
Telephones, Long Distance..	3444	Tiles,		Tops,	
“ Main Line..	3444	“ Vitrified..	3479	“ Radiator (Marble)..	3510
“ Magneto..	3444	Tills, Alarm..	3480	“ Radiator (Slate)..	3115
“ Warehouse..	3444	Timber, Bridge..	3482	“ Soil Pipe (Anti-Freezing)..	3507
Telescopes, Astronomical..	3445	“ Dimension..	3482	“ Waggon (Canopy)..	3513
“ Surveyors' Micro-		“ Limits..	3481	“ Wash Stand (Slate)..	3115
meter..	3445	Tin, Bar..	3483	Torches, Alcohol..	3516
Temples, Loom..	3446	“ Crystals..	3484	“ Gasoline..	3516
Tenoners, Blind Slat..	3447	“ Feathered..	3483	“ Oil..	3516
“ Sash, Door and Blind..	3447	“ Oxymuriate..	3484	“ Sulphur..	3518
Tents, Army and Camp..	2888	Tins, Lithographed..	3485	“ Tin..	3516
“ Canvass..	2888	Tinctures..	3487	Torpedoes, Track..	3421
Terebene..	3450	Tinctures, Warburg's..	3488	Tow, Carded..	3517
Terra Cotta, Architectural..	3449	Tinware, Decorated..	3485	“ Paper Stock..	3517
“ “ Plain and Orna-		“ Decey..	3486	“ Upholsterers'..	3517
mental..	3449	“ Japanned..	3486	Towelling..	3026
“ “ Porous..	3449	“ Embossed..	3486	Towers, Steel Wind Mill..	3519
Terrets and Hooks..	3451	“ Lithographed..	3485	Toys, Iron..	3522
Testers, Milk..	3452	“ Pieced..	3486	“ Tin..	3520
Thermostats, (Fire Alarm)..	3453	“ Pressed..	3486	“ Wood..	3521
“ Heat..	3453	“ Stamped..	3486	Tracks, Barn Door..	3523
“ Incubator..	3453	Tips, Chair..	3490	“ Hay Carrier..	3523
“ Regulating..	3453	“ Cue..	1080	“ Iron..	3523
Thills, Carriage..	3809	“ Crutch (Rubber)..	3490	“ Over Head..	3523
Thimbles, Asbestos Packed..	3455	“ Furniture (Rubber)..	3490	Transets, Surveyors'..	3524
“ Asbestos Pipe..	3455	“ Neck Yoke..	3489	Transmissions, Rope (Wire)..	3525
“ Extension..	3454	“ Pole and Thill..	3489	Transformers, Telephone..	3526
“ Rubber..	3457	“ Rubber..	3490	Transmitters, Telephone..	3526
“ Silver..	3458	“ Shaft..	3489	Traps, Cess Pool..	1622
“ Stove Pipe..	3454	“ Syringe..	3490a	“ Drone Bee..	3525
“ Stove Pipe (Porous		Tires, Bicycle (Pneumatic)..	3491	“ Fly..	3530
Tin)..	3456	“ Solid Rubber..	3491	“ Pipe (Iron)..	3534
“ Stair (Iron)..	3460	“ Steel..	3492	“ Pipe (Lead)..	3534
Threads, Silk..	3088	Tissue, Gutta Percha..	3493	“ Porcelain (Sanitary)..	3532
Threaders, Bolt and Pipe..	3459	Toasters, Wire..	3494	“ Rat and Mouse..	3533
Threshers, Bean..	3428	Tobacco, Chewing..	3496	“ Sewer Gas..	3534
“ Clover..	3461	“ Granulated..	3496	“ Steam (Balance Valve)..	3534
“ Grain..	3461	“ Leaf..	3495	“ Steam (Newton's Patent)..	3529
“ and Separators..	3461	“ Plug..	3496	“ Steam (Iron Pipe)..	3534
Thyroidin..	3463	“ Plug Cut..	3496	“ Ventilator (Anti-Siphon-	
Thyroids..	3463	“ Smoking..	3496	ing Back Air)..	3531
Tickings, Cotton..	3462	“ Twist..	3496	Trays, Ash (Plated)..	3539
Ties, Back Stay..	3467	Toboggans..	1354	“ Brass..	3536
“ Bale..	3465	Tombs, Marble..	3498	“ Bread..	3537
“ Lath and Shingle..	3464	Tomatoes, Canned..	611	“ Child's..	3537
“ Railway..	3466	Tongs, Coal..	3500	“ Crumb..	3537
“ Wall..	3467a	“ Double Seamer..	3501	“ Jewelers'..	3539
Tighteners, Belt..	3470	“ Fire..	3500	“ Knife..	3537
“ Guy..	3469	“ Hog..	3500	“ Plated..	3539
“ Wire Fence..	3468	“ Hoisting..	3499	“ Soap..	3538
Tights, Equestrian..	3471	“ Ice..	3499	“ Tea..	3537
Tile, Concrete..	3472	“ Meat..	3500	“ Tin..	3537
“ Drain..	3479	“ Pipe..	3502	Treads, Bicycle..	2441
“ Encaustic..	3475	“ Roofing..	3501	“ Stair..	3540
“ Enamelled and Glazed..	3473	“ Waggon..	3503	“ Stair (Rubber)..	3540
“ Metallic Roofing..	3478	Tongues, Beef, Lamb..	2577	Trees, Boot and Shoe..	3541
“ Stone Floor..	3474	Tools, Oil Well..	3505	“ Gig..	3541a
“ Terra Cotta..	3479	“ Tin Roofing..	3506	“ Saddle..	3541a
“ Vitrified Roofing..	3479	Tops, Bottle (Wood)..	3508	Trellises, Wire..	3542
Tiles, Agricultural..	3479	“ Cab (Leather)..	3514	Tricycles, Children's..	644
“ Art..	3477	“ Carriage (Leather)..	3514	“ Invalids'..	644
“ Encaustic..	3475	“ Chimney (Metal)..	3511	Trimmers, Cheese Box..	3545
“ Floor..	3479	“ Chimney (Salt Glazed)..	3515	“ Finger Nail..	3544
“ Open Hearth..	3477	“ Chimney (Revolving)..	3511	“ Spoke..	3543
“ Roofing (Iron)..	3478	“ Cork..	3512	“ Welt..	2119
“ Metallic..	3478	“ Counter (Slate)..	3509	Triturates..	3546
“ Ornamental Iron..	3478	“ Furniture (Marble)..	3510	Troughs, Eaves, (Metal)..	3547
“ Plain (Iron)..	3478	“ Furniture (Slate)..	3509	“ Grindstone..	3550
“ Stone..	3474	“ Furniture (Slate)..	3115	“ Iron Swine..	3550
“ Slate..	3476	“ Mantel (Marble..)	3510	“ Oil Dip..	3549
		“ Ornamental Metal..	3511	“ Portable Scalding..	3552

INDEX TO ARTICLES.

	No.		No.		No.
Throughs,		Tubs,		Underwear,	
“ Watering . . . . .	3550	“ Laundry (Stoneware) . . .	3583	“ Cotton . . . . .	3609
“ W.C. (Iron) . . . . .	3548	“ Scalding . . . . .	2375	“ Knit . . . . .	3610
“ W.C. (Sectional) . . . . .	3548	“ Self-Dumping . . . . .	565	“ Lisle Thread . . . . .	3608
Trowels, Brick . . . . .	3553	“ Self-Filling . . . . .	565	“ Silk . . . . .	3608
“ Garden . . . . .	3551	“ Wash . . . . .	2375	“ Tropic . . . . .	3610
“ Plastering . . . . .	3553	“ Wooden . . . . .	2375	“ White Cotton . . . . .	3609
Trucks, Bag . . . . .	3560	Tubes, Asbestos . . . . .	55	“ Wool (Combination) . . . . .	1201
“ Baggage . . . . .	3556	“ Boiler . . . . .	3575	Underwear, Woolen . . . . .	3610
“ Barrel . . . . .	3560	“ Boiler (Locomotive) . . . . .	3576	Upsetters, Tire . . . . .	3612
“ Brick . . . . .	3557	“ Brass . . . . .	3572	Ureometers . . . . .	1811
“ Cotton . . . . .	3560	“ Copper . . . . .	3572	Urns, Cast Iron . . . . .	3618
“ Dry Goods . . . . .	3554	“ Cotton Mill . . . . .	3568	“ Hot Water . . . . .	3619
“ Electric Car (Brill Pat.) . . . . .	3559	“ Glass . . . . .	3569	“ Stove (Cast Iron) . . . . .	3618
“ Express . . . . .	3556	“ Grain Drill . . . . .	3574	“ Stove (Spun Metal) . . . . .	3619
“ Fire Department . . . . .	3555	“ Mailing . . . . .	3573	“ Tea and Coffee . . . . .	3620
“ Floor . . . . .	3554	“ Pneumatic Despatch . . . . .	3571	Urinals, C.C. Ware . . . . .	3617
“ Flour . . . . .	3556	“ Speaking . . . . .	3570	“ Hand . . . . .	3616
“ Framed Hand . . . . .	3560	“ Water Gauge (Glass) . . . . .	3569	“ Iron . . . . .	3613
“ Freight . . . . .	3558	Tubing, Acid (Rubber) . . . . .	3580	“ Rockingham Ware . . . . .	3616
“ Hook and Ladder . . . . .	3555	“ Chemical (Rubber) . . . . .	3580	“ Rubber . . . . .	3615
“ Hook and Ladder (Ex- tension) . . . . .	3555	“ Corrugated Rubber . . . . .	3580	“ Slate . . . . .	3614
“ Iron . . . . .	3554	“ Fire Extinguisher . . . . .	3580	Valances . . . . .	3621
“ Piano . . . . .	3554	“ Flexible . . . . .	3580	Valises, Leather . . . . .	3563
“ Platform . . . . .	3554	“ Gas (Rubber) . . . . .	3580	Valves, Acid . . . . .	3624
“ Spiral Ladder . . . . .	3555	“ Hard Rubber . . . . .	3580	“ Air . . . . .	3624
“ Stove . . . . .	3554	“ Oil Well . . . . .	3579	“ Angle . . . . .	3630
“ Warehouse . . . . .	3560	“ Well . . . . .	3578	“ Asbestos Packed . . . . .	3623
Trumpets, Ear . . . . .	3561	Tugs, Steam (Lumbermen's) . . . . .	3590	“ Back Pressure . . . . .	3630
“ Fire (Silver Plated) . . . . .	3562	Tuques, Wool . . . . .	1854	“ Balanced . . . . .	3623
Trunks, Canvas . . . . .	3563	“ Worsted . . . . .	1854	“ Ball . . . . .	3623
“ Covered . . . . .	3563	Turkey, Canned . . . . .	612	“ Brass . . . . .	3623
“ Crystalized . . . . .	3563	Turn Buckles . . . . .	520	“ Corner . . . . .	3623
“ Marbleized . . . . .	3563	Turnings, Wood . . . . .	3591	“ Cross . . . . .	3623
“ Sample . . . . .	3563	Turpentine . . . . .	2381	“ Float (Brass) . . . . .	3623
“ Sole Leather . . . . .	3563	Tuyeres and Fittings (Bronze) . . . . .	3592	“ Flushing . . . . .	3623
“ Travellers' . . . . .	3563	Tweeds, Waterproof . . . . .	3593	“ Gas Works . . . . .	3630
“ Tourists' . . . . .	3563	“ Woolen . . . . .	3594	“ Gate . . . . .	3630
“ Toy . . . . .	3563	Twills, Cotton . . . . .	3594	“ Globe . . . . .	3623
“ Wooden Box . . . . .	3563	Twine, Asbestos . . . . .	55	“ Hydraulic . . . . .	3630
“ Veneer Box . . . . .	3563	“ Bag . . . . .	3598	“ Iron . . . . .	3630
Trusses, Barrel . . . . .	3564	“ Binder . . . . .	3596	“ “ Jenkin ” (Automatic) . . . . .	3626
“ Bridge . . . . .	3565	“ Cotton . . . . .	3598	“ J. M. T. . . . .	3629
“ Building . . . . .	3565	“ Flax . . . . .	3597	“ Lock . . . . .	3623
“ Electric . . . . .	3566	“ Hemp . . . . .	3597	“ Locomotive . . . . .	3623
“ Flour Barrel (“ Gordon's ”) . . . . .	3564	“ Jute . . . . .	3597	“ Lunken Patent . . . . .	3625
“ Hard Rubber . . . . .	3566	“ Lath . . . . .	3464	“ Oil . . . . .	3630
“ Leather Covered . . . . .	3566	“ Manilla . . . . .	3597	“ Pop Safety . . . . .	3623
“ Roof . . . . .	3565	“ Sail . . . . .	3598	“ Pop Safety (Marine) . . . . .	3623
“ Spring . . . . .	3566	“ Seine . . . . .	3598	“ Quick Opening . . . . .	3623
“ Steel . . . . .	3565	“ Upholsterers' . . . . .	3598	“ Radiator . . . . .	3627
“ Web . . . . .	3566	“ Wrapping (Cotton) . . . . .	3598	“ Reducing . . . . .	3623
Tryers, Butter . . . . .	3567	“ Wrapping (Fibre) . . . . .	3597	“ Regrinding Check . . . . .	3623
“ Cheese . . . . .	3567	Twist, Button Hole . . . . .	3599	“ Regrinding Globe . . . . .	3623
“ Flour . . . . .	3567	“ Machine . . . . .	3599	“ Rubber . . . . .	3624
Tubs, Bath (Copper) . . . . .	3588	“ Purse . . . . .	3599	“ Sewer . . . . .	3630
“ Bath (Copper) . . . . .	3588	“ Silk . . . . .	3599	“ Steam . . . . .	3627
“ Bath (Folding) . . . . .	3587	“ Tram . . . . .	3599	“ Stop . . . . .	3630
“ Bath (Steel Clad) . . . . .	3589	Twisters, Ring . . . . .	3600	“ Straight Way (Iron) . . . . .	3630
“ Bath (Zinc) . . . . .	3588	Type, Brass . . . . .	3602	“ Straight Way (“Lunken”) . . . . .	3625
“ Bath (Sanitary) . . . . .	3589	“ Press . . . . .	3601	“ Tank . . . . .	3630
“ Brewers' Boiling . . . . .	3582	“ Rubber . . . . .	3601	“ “ Van Suken ” (Auto- matic) . . . . .	3626
“ Butter (Tin Lined) . . . . .	3584	“ Rubber . . . . .	3602	“ Waste . . . . .	3630
“ Butter (Stone) . . . . .	3585	“ Steel . . . . .	3603	“ Water . . . . .	3627
“ Cedar . . . . .	2375	Typewriter “ Blickensderfer ” . . . . .	3604	“ Water Closet (Float) . . . . .	3628
“ Fibre . . . . .	2373	Umbers, Burnt . . . . .	3605	“ Water Relief . . . . .	3630
“ Hoisting . . . . .	565	“ Raw . . . . .	3605	“ Water Works . . . . .	3630
“ Laundry (Granite) . . . . .	3586	Umbrellas, Cotton . . . . .	3606	“ Y . . . . .	3630
“ Laundry (Slate) . . . . .	3581	“ Silk . . . . .	3606	Vans, Furniture . . . . .	3632
		“ Waggon . . . . .	3607		
		Underwear, Arctic . . . . .	3610		

INDEX TO ARTICLES.

	NO.		No.		NO.
Vanes, Weather	3631	Veneers,		Wagons,	
Varnish, Agricultural	3635	“ Furniture	3654	“ Lorrie	3676
“ Asphaltum	3634	“ House Decoration	3652	“ Lumber	3676
“ Black	3634	“ Mirror Back	3652	“ Mail	3676
“ Body	3634	“ Organ and Piano	3654	“ Market	3676
“ Brewers'	3635	“ Trunk	3654	“ Milk	3676
“ Cabinet Makers'	3635	Vensoline	3655	“ Mountain	3675
“ Carriage Makers'	3635	Ventilators, Building	3659	“ One Horse	3675
“ Dipping	3634	“ Rotary "Aeolian"	3656	“ Ore	3675
“ Furniture Makers'	3635	“ Stable	3657	“ Patrol	3679
“ Gear	3636	“ Chimney	3659	“ Road	3679
“ Interior	3635	“ Church Window	3658	“ Spring	3679
“ Lithographic	3636	“ Door	3659	“ Spring Truck	3679
“ Oil Cloth	3634	“ Wall	3659	“ Toy	3678
“ Railway	3636	Vermicelli	3660	“ Toy Express	3678
“ Rubbing	3634	Vessels, Acid	3661	“ Truck	3675
“ Shellac	3634	“ Chemical (Stoneware)	3662	“ Two Horse	3675
“ Shingle	3637	“ Sailing	3663	“ Undertakers'	3679
“ Spar	3636	Vests, Ribbed, Knitted	3664	Wagonettes	3680
“ Stove Pipe	3633	“ Woolen	1204	Wainscoting, Builders	3682
“ Wagon	3636	Viaducts, Iron and Steel	3665	“ Church	3682
“ Whip	3634	Victorias (Carriages)	646	“ School House	3682
Varnishes, Car Shop	3635	Vinegar, Cider	3666	“ Slate	3681
“ Coach	3636	“ Fruit	3666	“ Soft and Hard	
“ House Painters'	3635	“ Malt	3666	“ Wood	3682
“ Japanners'	3635	“ Proof	3666	“ Office	3682
“ Leather Top	3636	“ Raspberry	3666	“ Parquet	3682
“ Marbleizers	3636	“ White Wine	3666	Waiters, Basement	3683
“ Piano Makers'	3635	Vise and Anvil (Combined)	38	“ Dumb	3683
“ Printers'	3635	Vises, Amateur	3669	“ Hotel	3683
“ Spirit	3635	“ Bench	3669	“ Restaurant	3683
Vases, Brass	3639	“ Blacksmiths'	3669	Wallets, Leather	3684
“ Coal	3642	“ Farmers'	3669	Wardrobes, Office	3685
“ Coal (Brass)	3639	“ Foot	3669	Ware, Chesterfield	3686
“ Decorated (Iron)	3641	“ Foot	3669	“ Electric (Porcelain)	3688
“ Flower (Iron)	3641	“ Hand	3669	“ Sanitary	3687
“ Garden	3641	“ Heavy Chipping	3669	“ Yellow	3689
“ Iron	3641	“ Horseshoe	3669	Warmers, Foot	3692
“ Lawn (Stoneware)	3640	“ Jewelers'	3669	Warps, Blanket	3672
“ Lawn (Iron)	3641	“ Milling Machine	3669	“ Carpet	3672
“ Park	3640	“ Offset Jaw	3669	“ Chain Beam	3672
“ Plated	3644	“ Parallel	3669	“ Cotton	3672
“ Soap	3643	“ Pipe	3669	Washers, Air Brake	3695
“ Stoneware	3640	“ Pipe (Interchangeable)	3669	“ Axle	3700
“ Terra Cotta	3645	“ Saw	3669	“ Bolt	3700
Vaseline	3638	“ Silent Saw	3669	“ Bottle	3694
Vats, Cheese	3646	“ Solid Box	3669	“ Brass (Cast)	3699
“ Cooling	3646	“ Swivel	3669	“ Car	3700
“ Cream	3646	Voltmeters	3670	“ Carriage	3697
“ Steam Cheese	3646	Wadding, Cotton	3671	“ Cloth (Woolen Mill)	3701
Vaults, Bank	3648	Wafers, Headache ("Stearns")	3673	“ Clothes, "Dowswell"	3695
“ Cemetery (Slate)	3647	Wagons, Bakers'	3679	“ Cork	3698
“ Grave	3649	“ Basket	3677	“ Gauge Glass	3694
“ Safe Deposit	3648	“ Brewers'	3679	“ Hose	3695
“ Steel	3648	“ Business	3679	“ Iron	3700
“ and Safes	3648	“ Butchers'	3679	“ Lead	3698
Vegetables, Canned	611	“ Children's	645	“ Leather	3697
Velocipedes, Children's	644	“ Coal and Coke	3675	“ Malleable	3700
“ Railway	3650	“ Coal (Automatic Dump)	3676	“ Prop (Carriage)	3702
Veneers, Basket	3654	“ Delivery	3679	“ Railway Track	3700
“ Berry Box	3652	“ Democrat	3679	“ Rubber	3695
“ Brush Back	3653	“ Express	3679	“ Special	3700
“ Car	3654	“ Farm	3675	“ Steel	3700
“ Carriage	3654	“ Freight	3675	Waste, Bating	171
“ Cheese Box	3651	“ Furniture	3633	“ Cotton	3705
“ Cutter Body	3652	“ Grain	3675	“ Cotton (Rare)	3703
“ Dash	3654	“ Grocery	3679	“ Wiping	3690
“ Desk	3652	“ Ice	3675	“ Wool	3704
“ Fancy	3652	“ Invalid (Basket)	3677	Water, Distilled	3706
“ Fanning Mill	3654	“ Laundry	3679	“ Soda	20
		“ Log	3675	Waters, Aerated	20



INDEX TO ARTICLES.

Waters,		No.	Wheels,		No.	Whistles,		No.
"	Distilled..	3706	"	Foundry..	3749	"	Harmony..	3773
"	Lithia..	3708	"	Friction..	3736	"	Locomotive..	3772
"	Medicated..	3691	"	Gear..	3763	"	Steam..	3772
"	Medicinal..	3707	"	Hand Car..	3761	"	Steam Gong..	3772
"	Mineral..	20	"	Hand Truck..	3761	"	Toy..	3774
"	Potass..	3707	"	Household (Emery)..	3757	Wicks, Candle..		3775
"	Table..	3708	"	Iron Hub..	3729	"	Cotton..	3775
"	Vichy..	3708	"	Jerker (Oil Pump)..	3735	"	Cotton Ball..	3775
Wax, Bottle..		3710	"	Maganese Bronze Pro-		"	Lamp..	3775
"	Refined..	3711	"	peller..	3741	"	Lamp (Miners')..	3775
"	Paraffine..	3712	"	Platform Truck..	3761	"	Oil Stove..	3775
"	Tanners'..	3712	"	Polishing..	3749	Wicking, Asbestos..		3776
Weaners, Calf (Adjustable)..		3713	"	Propeller..	3760	Wigs..		3777
Weasands, Hog..		3714	"	Railway Car..	3759	Winches, Anchor..		3778
Webbs, Saw..		3715	"	Ratchet..	3762	"	Hand..	3778
Webbings, Bolt Cloth..		3717	"	Sarven Patent..	3753	"	Horsepower..	3778
"	Boot and Shoe..	3717	"	Saw Gumming..	3749	"	Steam..	3778
"	Elastic..	3716	"	Saw Sharpening..	3749	Winders, Bobbin..		3780
"	Garter..	3716	"	Sectional Car..	3759	"	Yarn (Hand)..	3779
"	Girth..	3717	"	Spinning (Yarn)..	3733	"	Yarn (Power)..	3779
"	Halter..	3717	"	Sprocket..	3738	Windlasses, Chain..		3778
"	Loom..	3716	"	Steering (Ship)..	3747	"	Hand..	3778
"	Match..	3717	"	Steering (Yacht)..	3747	"	Rope..	3778
"	Non-Elastic..	3717	"	Street Car..	3759	"	Ships..	3778
"	Suspender..	3716	"	Tanners' Paddle..	3746	Windows, Car..		3782
Wedges, Iron and Steel..		3719	"	Tanners' Slush..	3744	"	Memorial..	3783
"	Stone..	3719	"	Fur..	3732	"	Ornamental..	3783
"	Wood Splitting..	3719	"	Tool Grinding..	3749	"	Stained (Church)..	3783
Weights, Advertising..		3722	"	Trolley..	3748	Windvanes..		3784
"	Beam Scale..	3721	"	Tire Measuring..	3745	Wine of Cod Liver Oil (Steam's)		3787
"	Bottom (Scale)..	3721	"	Wagon..	3742	Wines, Alicante..		3788
"	Clock (Iron)..	3725	"	"Warner Patent"..	3753	"	Catawba (Sweet & Dry)	2788
"	Dumb Waiter..	3725	"	Waterproof..	3757	"	"Chateau Pelee Medoc"	2785
"	Elevator..	3725	"	Water (Direct Impulse)	3754	"	Communion..	3790
"	Hitching (Lead)..	3723	"	Water (Horizontal)..	3754	"	Dry..	3790
"	Hitching (Iron)..	3725	"	("Leffel")..	3755	"	High..	3789
"	Office Desk..	3722	"	Water ("Perfection")	3756	"	Isabella..	3788
"	Paper (Glass)..	3722	"	Water (Vertical)..	3754	"	Medicated..	3791
"	Sash (Lead)..	3724	"	Water ("Vulcan")..	3754	"	Medicinal..	3786
"	Sash (Iron)..	3725	"	Water Turbine..	3758	"	Native..	3790
"	Sash (Lead)..	3724	"	Worm..	3762	"	Port..	3788
"	Scale (Iron)..	3720	"	Wheelbarrow (Wood)..	3743	"	Sherry..	3788
Wells, Copying..		3726	"	Zinc..	3732	"	Sweet..	3790
"	Ink..	3726	Wheelbarrows, Canal (Iron)..		3764	"	St. Augutine..	3788
"	Ore..	3725a	"	Garden (Iron)..	3764	Wipers, Machinery..		3792
"	Water..	3726	"	Garden (Wood)..	3765	Wire, Aluminum Brass..		3793
Welts, Shoe..		3727	"	Mortar..	3764	"	Annealed..	3796
Welting, "Goodyear"..		3728	"	Railroad..	3764	"	Baling..	3796
Wheels, Agricultural..		3729	"	Sideboard..	3765	"	Barb..	3794
"	Barrow..	3761	Whiffletrees..		3765	"	Bonnet..	3796
"	Bicycle..	3737	Whips, Carpet Wire..		3766	"	Bottling..	3796
"	Brass..	3732	"	Carriage..	3767	"	Brass..	3796
"	Bristle Brush (Barber's)	3739	"	Coach..	3767	"	Broom and Brush..	3796
"	Buffing and Polishing..	3749	"	Dog..	3767	"	Cable..	3795
"	Bull (Mill)..	3734	"	Drovers'..	3767	"	Clothes Line..	3795
"	Carriage..	3742	"	Fancy..	3767	"	Copper..	3796
"	Caster (Porcelain)..	3752	"	Farm..	3767	"	Corset..	3796
"	Children's Carriage..	3750	"	Rattan..	3767	"	Electrical..	3802
Wheels, Chilled Cast..		3759	"	Rawhide..	3767	"	Electric Light..	3795
"	Chilled Steel Car..	3759	"	Riding..	3767	"	Fence (Fancy)..	3795
"	Clay Grinding..	3730	"	Wagon..	3767	"	Fence (Iron)..	3794
"	Copper..	3732	"	Whalebone..	3767	"	Florists'..	3796
"	Crescent (Emery)..	3751	Whiskey, Blended..		3770	"	Fuse Connecting..	1513
"	Corundum..	3757	"	Malt..	3770	"	Galvanized Iron..	3795
"	Drive (Engine)..	3759	"	"Old Time"..	3769	"	Gold..	3797
"	Emery..	3749	"	Rye..	3770	"	Ribbon..	3795
"	Fifth ("Birdsall's")..	3731	"	White Wheat..	3769	"	Rolled Plate..	3797
"	Fifth "Cincinnati"..	3731	Whisks, Broom..		3771	"	Silk Covered..	3798
"	Fifth Derby..	3731	Whistles, Cast Iron..		3773	"	Silver..	3790
"	Fly..	3740	"	Chime (Steam)..	3772	"	Spring..	3796

INDEX TO ARTICLES.

	No.		No.		No.
Wire,		Workers, Butter...	3803	Wringers,	
“ Stove Pipe...	3796	Worms, Brewers'...	3804	“ Clothes (Power)...	3823
“ Telegraph...	3795	“ Gearing...	3805	“ Hosiery (Power)...	3828
“ Telephone...	3795	“ Still (Copper)...	3278	Yardsticks...	3828
“ Tinman's...	3796	Wraps, Knee...	3815	Yachts, Sailing...	3827
“ Twist...	3794	Wrench, Seat Lock, Key Lock...	3816	“ Steam...	3826
“ Underground...	3795	Wrenches, Adjustable Reamer...	3817	Yarns, Asbestos...	55
“ Weaving...	3796	“ Alligator...	3822	“ Colored Cotton...	3831
Wirework, Artistic...	3801	“ Always Ready...	3819	“ Cotton...	3831
“ Builders'...	3801	“ Axle Nut...	3821	“ Cotton Carpet...	3831
“ Diamond...	3801	“ Bicycle...	3818	“ Electric Wire (Cotton)...	3833
“ Elevator...	3801	“ Buggy...	3819	“ Fingering...	3835
“ Ornamental...	3801	“ Bull Dog...	3819	“ Hambroline...	3830
Wood, Bent...	3809	“ Carriage...	3821	“ Hosiery (Woolen)...	3835
“ Cord...	3807	“ Claw Hammer...	3821	“ Hosiery (Cotton)...	3831
“ Kindling (Bundled)...	3808	“ Gas Cock...	3821	“ Knitting (Cotton)...	3831
“ Poplar (Prepared)...	3810	“ Key...	3822	“ Knitting (Woolen)...	3835
“ Pulp (Prepared)...	3810	“ Knife Handle...	3819	“ Marline...	3830
“ Pulp (Rouge)...	3811	“ Machinists'...	3820	“ Russian Hemp...	3830
“ Slab...	3807	“ Monkey...	3822	“ Silk...	3832
“ Spool (Prepared)...	3806	“ Nut...	3820	“ Tarred Lath...	3829
“ Spruce (Prepared)...	3810	“ Pipe...	3820	“ White (Cotton)...	3831
Woods, Neck Yoke...	3812	“ Plow...	3821	“ Wool Carpet...	3834
“ Singletree...	3812	“ Railroad Track...	3822	“ Worsted...	3835
“ Whiffletree...	3812	“ Reamer...	3817	Yeast, Compressed...	3836
Woodwork, Architectural...	3813	“ “S”...	3822	Yellow Ware...	3689
“ Ornamental...	3813	“ Spanner...	3822	Yokes, Axle...	3837
Wool, Fleece...	4844	“ Square...	3822	“ Neck...	3838
“ Merchant...	4844	“ Wagon...	3821	Zinc, Perforated...	3839
“ Pulled...	4843	Wringers, Clothes (Centrifugal)...	3824	“ White...	3840
“ Tub...	4843	“ Clothes (Hand)...	3825		
“ Mineral...	3814				

... NOTE ...

Always consult the Article Index for the article you want. And when you get the Manufacturers address in the body of the book be sure and look up his advertisement if he has a reference to one after his address as a great number of Manufacturers carry lines that they do not manufacture and therefore would not be Indexed for them, but may have embodied them in their advertisement.

This copy cost the owier Five Dollars and should not be LENT OUT.

THE MANUFACTURERS LIST CO.,  
MONTREAL.

# WHAT DOES A BUSINESS MAN WANT?

HE WANTS A . . . . .



## Double Liability Accident Policy

. . . IN THE . . .

MANUFACTURERS GUARANTEE  
AND ACCIDENT INSURANCE CO.

Head Office,  
Toronto, Canada.

### WHICH GUARANTEES

In case of accidental death or injury sustained  
anywhere (within the limits of the Policy):

**\$5,000** { For death.  
For loss of sight in both eyes.  
For loss of both feet.  
For loss of one hand and one foot . . . . .

**\$1,665** { For loss of one foot. }  
                  { For loss of one hand. }

**\$750** { For loss of one eye. }

or **\$25** per week for 52 consecutive weeks or total disability.

In case of death or accidental injury when riding  
as a passenger in any steam, cable, or electric  
conveyance, or whilst travelling as a passenger  
on the seas in first-class vessels (within the  
limits of the policy):

**\$10,000** { For death.  
For loss of sight in both eyes.  
For loss of both feet.  
For loss of both hands  
For loss of one hand and one foot.

**\$3,333** { For loss of one foot. }  
                  { For loss of one hand. }

**\$1,500** { For loss of one eye. }

**\$50** per week for 52 consecutive weeks of total disability.

*Total Premium for full combination,* **\$25 Per Annum** *Less Amounts at proportionate rates.*

**Manufacturers Life**  
Insurance Company,

HEAD OFFICE :

YONGE ST., COR. COLBORNE,  
...TORONTO, CAN.

GEORGE GOODERHAM, Pres. Bk. of Toronto, *President.*

WILLIAM BELL, Pres. Traders Bk., Toronto,

S. F. MCKINNON, Vice-Pres. Bd. of Trade, Toronto } *Vice-Presidents.*

JAMES F. W. ROSS, M.D., L.R.C.P., Eng. } *Medical Directors.*  
P. J. STRATHY, M.D., M.R.C.S., Eng. }

D. PARKS FACKLER, of New York, *Consulting Actuary.*

### *The Double Maturity Policy*



of this Company is admirably adapted to all who desire to accumulate a fund for their future support at a time when it is most likely to be needed, namely, the age of 65 or earlier. The policy is issued without any restriction as regards residence, travel, or occupation. It is indisputable after one year, and the rates are the lowest of any endowment in the market. . . . .



**J. F. JUNKIN,**  
GENERAL MANAGER.

**GEO. A. STERLING,**  
SECRETARY.

**R. JUNKIN,**  
SUPERINTENDENT.

JOHN L. BLAIKIE Esq.  
PRES.

E. W. RATHBUN Esq.  
VICE-PRES.

# THE BOILER INSPECTION & INSURANCE CO.

OF CANADA

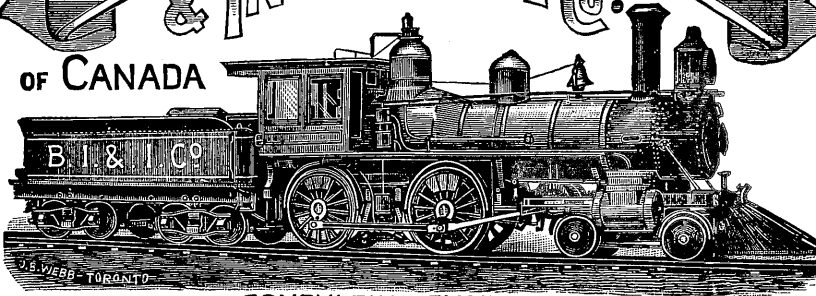

CONSULTING ENGINEERS

G. C. ROBB CHIEF ENGINEER  
A. FRASER SEC. TRES. HEAD OFFICE TORONTO

FOR

## Safety and Economy,

Engineering  
Advice  
Free to all  
Insured.

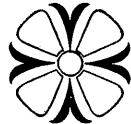

Have your Boilers Insured  
and Regularly Inspected...

### MONTREAL OFFICE:

Room 222 = = Board of Trade Building.

AGENTS FOR QUEBEC CITY:

OWEN MURPHY & NEPHEW.

AGENT FOR NOVA SCOTIA:

GEO. W. JONES, Halifax.



AGENT FOR NEW BRUNSWICK:

R. W. W. FRINK, St. John.



AGENT FOR MANITOBA:

ARTHUR STEWART, Winnipeg.

Head Office, Canada Life . . . . . Building, Toronto.

# MANUFACTURERS OF CANADA.

## 1—ACETATE—Sodium,—Lime.

Canada Paint Co., Montreal. *Advt. page 221.*  
 Canada Chemical Mfg. Co. Ltd., London, Ont.  
 Lyman Sons & Co., Montreal, Que.

## 2—ACCUMULATORS—Electric.

Toronto Electrical Works, Toronto, Ont.  
 Kay Electrical Works, Hamilton, Ont. *Advt. p. 233.*  
 Canadian General Electric Co. Ltd., Toronto, Ont.  
 Ness, McLaren & Bate, Montreal, Que. *Advt. p. 240.*

## 3—ACID—Pyroligneous.

Lyman Bros. & Co. Ltd., Toronto, Ont.  
 Rathbun Co. (The) Deseronto, Ont. *Advt. page 162.*

## 4—ACID—Arsenious, Benzoic, Chromic, Oxalic, Picric, Prussic, Salicylic, Stearic, Tannic, Tartaric, Acetic, Citric, Sulphurous, Phosphoric, Muriatic, Nitric, Sulphuric.

Vasey, R. E. Montreal, Que.  
 Victoria Chemical Co. Ltd., (The) Victoria, B. C.  
 Canada Chemical Mfg. Co. Ltd., London, Ont.  
 Lyman Bros. & Co. Ltd., Toronto, Ont.

## 5—ACID—Hydrofluoric.

Canada Chemical Mfg. Co. Ltd., London, Ont.

## 6—ACTIONS—Pianoforte.

Higel, Otto, Toronto, Ont. *Advt. page 190.*  
 Barthelmes, A. A. & Co., Toronto, Ont.

## 7—ADJUSTERS—Bicycle Spoke.

Goold Bicycle Co. Ltd., (The) Brantford, Ont.  
*Advt. page 220.*

## 8—ADZES—Carpenters, Ship Carpenters', Railroad, Coopers, Spanish, Round Edge.

*See No. 70.*

## 9—AERATORS—Milk.

Lancaster Machine Works, Lancaster, Ont.  
*Advt. page 248.*  
 Chown, W. W. & Co., Belleville, Ont. *Advt. p. 233.*  
 Bartlet, E. Hybla, Ont.  
 Macpherson, D. M. Lancaster, Ont.

## 10—AGRAVATORS—Emery Wheel.

Prescott Emery Wheel Co. Ltd., Prescott, Ont.  
*Advt. page 237.*  
 Hart Emery Wheel Co. Ltd., Hamilton, Ont.  
*Advt. page 166.*

## 11—AGITATORS—Automatic Milk.

Lancaster Machine Works, Lancaster, Ont.  
*Advt. page 248.*  
 Ewing, D. Warkworth, Ont.

## 12—ALABASTINE.

Alabastine Co. Ltd., (The) Paris, Ont. *Advt. p. 212.*

## 13—ALARMS—(Electric) Burglar, Automatic Fire, Fire.

Ness, McLaren & Bates, Montreal, Que. *Advt. p. 240.*  
 Toronto Electrical Works, Toronto, Ont.  
 Mount Bros., Montreal, Que.

## 14—ALARMS—Bicycle.

Goold Bicycle Co. Ltd., (The) Brantford, Ont.  
*Advt. page 220.*

## 15—ALARMS—Low-Water.

Robb Engineering Co. Ltd., Amherst, N. S.  
*See advt. inside front cover.*

## 16—ALBUMS—Scrap, Cardboard.

Brown Bros. Ltd., (The) Toronto, Ont.

## 17—ALBUMS—Photograph.

Reinhardt Mfg. Co., Montreal, Que.  
 Carstens Mfg. Co., Montreal, Que.

## 18—ALCOHOL.

Seagram, Joseph E., Waterloo, Ont.  
 Walker, Hiram & Sons, Ltd., Walkerville, Ont.  
 Wisner, J. P. & Sons, Ltd., Prescott, Ont.  
 Gooderham & Worts, Ltd., Toronto, Ont.

## 19—ALE—Porter and Stout.

Carling Brewing & Malting Co., London, Ont.  
 Copland Brewing Co., Toronto, Ont.  
 Canadian Brewing Co., Montreal, Que.  
 Eaton Bros., Owen Sound, Ont.  
 Hamilton, Jos., London, Ont.  
 Dow, Wm. & Co., Montreal, Que.  
 Dominion Brewing Co., Toronto, Ont.  
 Dawes & Co., Lachine, Quebec.  
 Davies Brewing & Malting Co., Toronto, Ont.  
 Keith, Alexander & Son, Halifax, N. S.  
 Jones Simeon, St. John, N. B.  
 Hayward, C. W. & Co., Halifax, N. S.  
 Macpherson, Gordon & Co., Cobourg, Ont.  
 Odell, C. J. & F. W., Sherbrooke, Que.  
 Montreal Brewing Co., Montreal, Que.  
 Molson, John H. R. & Bros., Montreal, Que.  
 Reinhardt, G. & Sons, Montreal, Que.  
 McCarthy, J. & Son, Prescott, Ont.  
 Brant-Lottridge Brewing Co. Ltd. Hamilton, Ont.  
 Toronto Brewing & Malting Co., Toronto, Ont.  
 O'Keefe Brewing & Malting Co., Toronto, Ont.  
 Sleeman, Geo., Guelph, Ont.  
 Kormann, M. E., Toronto, Ont.  
 Roy, Jos., Joliette, Que.  
 Prescott Brewing & Malting Co., Prescott, Ont.  
 Holiday, Thos., Guelph, Ont.  
 Labatt, John, London, Ont.  
 Rock Spring Brewery, Quebec, Que.  
 Boswell & Bro., Quebec, Que.  
 Brading, H. F. & Co., Ottawa, Ont.  
 Ambrose-Winslow Brewing & Malting Co., Port Hope, Ont.



Oland, S. Sons & Co., Halifax, N. S.  
Cosgrave Brewing Co., Toronto, Ont.  
Ottawa Brewing & Malting Co. Ltd., Ottawa, Ont.  
Walkerville Brewing Co. Ltd., Walkerville, Ont.

**20—ALE GINGER—Small Beer, Pop, Cream Soda, Sarsaparilla, Lemon Sour, Aerated Waters, Mineral Waters, Bottled Lemonade, &c., &c.**

Gurd Charles & Co., Montreal, Que. *Advt. page 235.*  
Rowe Frank W. & Co., Montreal, Que. *Advt. page 235.*

McLaughlin, J. J. Toronto, Ont.  
Ready, James, St. John, N. B.  
Robillard, C. & Bro., Montreal Que.  
Timmons, M. & Son, Quebec, Que.  
Wilson, Charles, Toronto, Ont.  
Donovan, W. H., Halifax, N. S.  
Dignard, P. & Co., Quebec, Que.  
Bigelow & Hood, Truro, N. S.  
Allen, Robert, Montreal, Que.  
Tune, T. & Son, London, Ont.  
Drolet & Co., Ottawa, Ont.

**21—ALKALOIDS—Alkalies, Alum.**

Canada Chemical Mfg. Co., London, Ont.  
Lyman, Bros. & Co., Toronto, Ont.

**22—ALLIGATORS—Lumbermans', "West & Peachy" Pat.**

West & Peachy, Simcoe, Ont. *Advt. page 215.*

**23—ALUMINUM—Spun.**

Chadwick Bros., Hamilton Ont. *Advt. page 206.*

**24—ALTARS—Stone, Marble.**

Forsyth, R., Montreal, Que.

**25—ALTARS (Wood)—Church, Lodge Room.**

Rhodes, Curry & Co. Ltd., Amherst, N. S. *Advt. page 158.*  
Globe Furniture Co. Ltd., Walkerville, Ont. *Advt. page 225.*  
Canadian Office & School Furniture Co. Ltd. (The), Preston, Ont. *Advt. page 210.*  
Paquet & Gadbout, St. Hyacinthe, Que.  
Rogers, Charles & Sons Co. Ltd., Toronto, Ont.

**26—AMALGAMATORS.**

Matheson, I. & Co., New Glasgow, N. S. *Advt. page 200.*

**27—AMMETERS.**

Whitney Electrical Instrument Co., Sherbrooke, Que.

**28—AMMONIA—Aqua, Muriate, Sulphide, Nitrate, Anhydrous.**

Canada Chemical Mfg. Co. Ltd., London, Ont.  
Vasey, T. E., Montreal, Que.

**29—AMMONIA—Household, Oxalate, Sulphite, Tartrate, Sulphate, Ammonium Bromide, Chloride, Hydrosulphuret, Amyl Acetate, Aqua Fortis.**

Varey, Thos. E. Montreal, Que.  
Canada Chemical Mfg. Co. Ltd., London, Ont.  
Lyman, Bros. & Co. Ltd., Toronto, Ont.  
Lyman, Sons & Co., Montreal, Que.  
Montreal Chemical Work, Montreal, Que.

**30—ANCHORS—Ship.**

Raney, Reid & Selby, Kingston, Ont.  
Carrier, Laine & Co., Levis, Que. *Advt. page 150.*

**31—ANDIRONS—Wrought Iron.**

Dennis Wire & Iron Works, London, Ont. *Advt. page 207.*

**32—ANDIRONS—Brass.**

Parker J. O. & Co., Toronto Ont. *Advt. page 253.*  
Dennis Wire & Iron Works, London, Ont., *Advt. page 207.*  
Mitchell, Robert & Co., Montreal. *Advt. page 213.*  
Hamilton Brass Mfg. Co., Hamilton Ont. *Advt. page 168.*  
New York Mantel & Decorating Co., Montreal, Que.

**33—ANEMIOGRAPHS.**

Foster, James, Toronto, Ont.

**34—ANEMOMETERS.**

Foster, James, Toronto, Ont.

**35—ANGLES—Steel, Iron.**

Nova Scotia Steel Co. Ltd., New Glasgow, N. S.  
Central Bridge & Engineering Co. Ltd., Peterborough, Ont. *Advt. page 214.*

**36—ANNUNCIATORS—Electric, Hotel, Elevator, House.**

Kay Electric Mfg. Co., Hamilton, Ont. *Advt. page 233.*  
Ness, McLaren & Bates, Montreal, Que. *Advt. p. 240.*  
Canadian General Electric Co. Ltd., Toronto, Ont.  
Mount Bros., Montreal, Que.  
Royal Electric Co. (The), Montreal Que.  
Bell Telephone Co. (The), Montreal Que.  
Toronto Electrical Works, Toronto, Ont.

**37—ANTIMONY—Chloride, Oxymuriate Powdered.**

Lyman Bros. & Co. Ltd. Toronto, Ont.  
Canada Chemical Mfg. Co. Ltd., London, Ont.

**38—ANVILS—Saw, Anvil, Vise & Drill Combined.**

Smart Mfg. Co. Ltd. (The James), Brockville, Ont. *Advt. page 178.*  
Ballantine, John & Co., Preston, Ont. *Advt. page 205.*

**39—APPLES—Evaporated.**

Aylmer Canning Co., Aylmer, Ont.  
Polley & White, Trenton, Ont. *Advt. page 255.*  
Miller A. C. & Co., Picton, Ont. *Advt. page 236.*  
Strathroy Canning & Preserving Co., Strathroy, Ont.  
Graham, R. J., Belleville, Ont.  
Miller, Polley & Onderdonk, Trenton, Ont.

**40—APRONS—Ladies Rubber, Nursery.**

Gutta Percha & Rubber Mfg. Co. Ltd., Toronto, Ont. *See inside back cover.*  
Canadian Rubber Co., Montreal, Que. *Advt. page 197.*  
Alpha Rubber Co. Ltd., Montreal, Que.

**41—APRONS—Leather, Blacksmith's, Lumberman's, Shoemaker's, Ice.**

Clarke, A. R. & Co., Toronto, Ont.  
Porter, Henry, Montreal, Que. *Advt. page 230.*  
Borbridge, S. & H., Ottawa, Ont.

**42—APRONS—Rubber Carriage, Endless.**

Gutta Percha & Rubber Mfg. Co., Ltd, Toronto, Ont. *See inside back cover.*

- Canadian Rubber Co., Montreal, Que. *Advt. p. 197.*  
 The Globe Rubber Co., Quebec, Que.  
 The Toronto Rubber Co., Toronto, Ont.
- 43—APRONS—(Oil Duck,) Carriage.**  
 Conboy, D., Toronto, Ont.  
 Leckie, J., Toronto, Ont.  
 Dowell, D., Montreal, Que. *Advt. page 203.*
- 44—APRONS—Cotton Duck, Brewers, Butchers, Waterproof.**  
 Soper, R., Hamilton, Ont. *Advt. page 229.*
- 45—ARBORS—Saw.**  
 Robb Engineering Co., Ltd. Amherst, N. S.  
*See inside front cover.*  
 Waring, White & Co., St. John, N. B. *Advt. p. 256.*  
 Matheson, I. & Co., New Glasgow, N. S.  
*Advt. page 200.*  
 McOuat & McRae, Lachute, Que. *Advt. page 205.*  
 Smart Mfg. Co., Ltd. (The James), Brockville, Ont.  
*Advt. page 178.*  
 Chalifoux, O. & Sons, St. Hyacinthe, Que.  
*Advt. page 232.*  
 Ballantine, John & Co., Preston, Ont. *Advt. page 205.*
- 46—ARCHES—(Wire,) Garden.**  
 Dennis Wire & Iron Works, London, Ont.  
*Advt. page 207.*  
 Meadows, Geo. B., Toronto, Ont.  
 Greening, B. Wire Co., Ltd. (The), Hamilton, Ont.
- 47—ARCHES—Steel.**  
 Central Bridge & Engineering Co., Ltd., Peterborough, Ont. *Advt. page 214.*
- 48—ARCHES—Terra Cotta.**  
 Beamsville Pressed Brick Co., Beamsville, Ont.  
*Advt. page 215.*  
 Taylor Bros., Toronto, Ont.
- 49—ARCHES—(Iron,) Garden, Brick Kiln.**  
 Dennis, R., London, Ont. *Advt. page 207.*  
 Carrier, Laine & Co., Levis, Que. *Advt. page 150.*
- 50—ARCTICS—Rubber.**  
 Canadian Rubber Co., Toronto, Montreal.  
*Advt. page 197.*
- 51—ARMLETS—Elastic.**  
 Stouffer, J. R. Co., Ltd. (The), Berlin, Ont.  
*Advt. page 185.*  
 Globe Suspender Co., (The), Rock Island, Que.  
 Glassford Bros & Pollock, Montreal, Que.
- 52—ARRESTERS—Wire, Spark.**  
 Carrier, Laine & Co., Levis, Que. *Advt. page 150.*  
 Dennis Wire & Iron Works, London, Ont.  
*Advt. page 207.*  
 Major Mfg. Co., Montreal, Que.  
 Meadows, Geo. B., Toronto, Ont.  
 Greening B. Wire Co., Ltd. (The), Hamilton, Ont.
- 53—ARRESTERS—Lightning.**  
 Ness, McLaren & Bate, Montreal, Que. *Advt. p. 240.*  
 Kay Electric Works, Hamilton, Ont. *Advt. page 233.*  
 Canadian General Electric Co., Ltd. Toronto, Ont.  
 Royal Electric Co. (The), Montreal, Que.
- 54—Arseniate of Sodium.**  
 Lyman Bro. & Co., Ltd., Toronto, Ont.

- 55—ASBESTOS—Crushed, Crude, Fibrized.**  
 Hopper, R. T. & Co., Black Lake, Que. *Advt. p. 239.*  
 King Bro., Quebec, Que. *Advt. page 240.*  
 Sclater Asbestos Mfg. Co. (The), Montreal, Que.  
*Advt. page 172.*
- 55—ASBESTOS, Cement (Retort and Furnace,) Cloth, Hangings, Millboard, Rope, Sheathing Twine, Yarns.**  
 Berry, M. B., Quebec, Que.  
 Sclater Asbestos Mfg. Co., Montreal, Que.  
*Advt. page 172.*  
 Hopper, R. T. & Co., Montreal, Que. *Advt. page 239.*
- 56—ASBESTINE.**  
 Canada Paint Co., Ltd., Montreal, Que. *Advt. p. 221.*
- 57—ASPIRATORS—Double, Aspirators, & Crushers, Combined. Aspirators & Purifiers, Corn Meal.**  
 Goldie & McCulloch Co. Ltd., Galt, Ont. *Advt. p. 159.*  
 Greey, Wm. & J. G., Toronto, Ont.
- 58—ATOMIZERS—Medical.**  
 Alpha Rubber Co. Ltd., Montreal, Que.
- 59—AUGERS—Blacksmith's, Bone.**  
 Beaver File Works Co., Lévis, Que. *Advt. page 241.*
- 60—AUGERS—Pump.**  
 Young Bros., Almonte, Ont. *Advt. page 250.*  
 McDougall, R. & Co., Galt, Ont. *Advt. page 199.*  
 Beebe, S. L., Markham, Ont.  
 Gardner Tool Co., (W. R.) Brockville, Ont.
- 61—AUGERS—Earth, Post Hole.**  
 Ives, H. R. & Co., Montreal, Que. *Advt. page 200.*  
 Woodyatt, A. R. & Co., Guelph, Ont. *Advt. page 207.*  
 Smart Mfg. Co. Ltd., (The James), Brockville, Ont.  
*Advt. page 178.*
- 62—AUGERS—Boom, Carpenters', Eye, Hollow, Gas Fitters, Millwrights', Nut, Post, Ring, Ship, Taper, Boring Machine.**  
 Gardner Tool Co. (W. R.) Brockville, Ont.  
 Gilmore, G., Cote St. Paul, Que.
- 63—AUGERS—Malleable Fruit.**  
 Burrow, Stewart & Milne, Hamilton, Ont.
- 64—AUGERS—Piping, Power Pump Boring.**  
 Young Bros., Almonte, Ont. *Advt. page 250.*
- 65—AUTOHARPS.**  
 Bell Piano & Organ Co. Ltd. (The), Guelph, Ont.  
 American Autoharp Co., Toronto, Ont.
- 66—AWLS—Brad, Harness, Pegging, Shoemakers, Scratch.**  
 Smart Mfg. Co. Ltd. (James), Brockville, Ont.  
*Advt. page 178.*  
 Brown, Boggs & Co., Hamilton, Ont. *Advt. page 193.*
- 67—AWNINGS—Canvass.**  
 Pike, D., Toronto, Ont. *Advt. page 182.*  
 Soper, R., Hamilton, Ont. *Advt. page 229.*  
 Palyfair, Jas. & Co., Colingwood, Ont. *Advt. page 223.*  
 Sonne, Thomas, Montreal, Que.  
 Forhan, Thos. Halifax, N. S.  
 Montreal Tent, Awning & Tarpaulin Co., Montreal, Que. *Advt. page 232.*

Small, David, Charlottetown, P. E. I.  
Emerson & Hague, Winnipeg, Man.  
Oldrieve & Horn, Kingston, Ont.  
Morris, J. W., Montreal, Que.  
Shirley, John K. Calgary, N. W. T.  
Stone, James, Port Hope, Ont.  
Alleyn, John A., Quebec, Que.  
Cole's National Mfg. Co., Ottawa, Ont.  
Turner, J. J. & Son, Peterborough, Ont.

**68—AXES—Asphalt Chopping.**

Nie & Whitfield, Hamilton, Ont.

**69—AXES—Boys', Hunters', Stone.**

Whitman & Barnes Mfg. Co. St. Catherine, Ont.

**70—AXES—Broad, Coopers', Carpenters', Double Bitted Fireman's, Hand, Meat, Ship, Slaughtering, Spanish, Turpentine.**

Welland Vale Mfg. Co., St. Catherines, Ont. *Advt. p. 241*  
Whiting Mfg. Co. (A. S.), Oshawa, Ont. *Advt. p. 241*  
Rixford, (O. S.) Mfg. Co., Bedford, Que. *Advt. p. 241*  
St. Maurice Tool & Axe Works, Three Rivers, Que.  
Warnock, James & Co., Galt, Ont.  
Canada Axe & Harvest Tool Co., Cote St. Paul, Que. *Advt. page 241*  
Dunlop & Co., Pembroke, Ont.  
Gardner, W. R. Tool Co., Brockville, Ont.  
Broad, E. & Sons, St-Stephen, N. B.  
Fowler, Josiah, St. John, N. B.

**71—AXLES—Tubular, Carriage, Wagon.**

Ashley Carriage Works, Belleville, Ont. *Advt. p. 204*

**72—AXLES—Heavy, Crank.**

Donaldson, Robert & Sons, Montreal, Que. *Advt. p. 251*

**73—AXLES—Wrought, Carriage, Concord, Hammered, Half Collenge, Full Collenge, Sulky, Vehicle, Wagon.**

Coghlin, B. J., Montreal, Que.  
Campbell Bros., St. John, N. B.  
Gananoque Spring & Axle Co., Gananoque, Ont.  
Pepper, T. & Co., Guelph, Ont.  
Beauchemin & Sons, Sorel, Que.

**74—AXLES—Locomotive, Steel Car, Steel Railway Car, Heavy, Forged.**

Canadian Locomotive & Engine Co. Ltd., Kingston, Ont. *Advt. page 175*  
Nova Scotia Steel Co. Ltd., New Glasgow, N. S.  
Portland Rolling Mills, St. John, N. B. *Advt. p. 195*

**75—BALLS—Rubber.**

Alpha Rubber Co. Ltd., Montreal Que.

**76—BALLS VALVES—Water Closet Rubber.**

Toronto Rubber Co. Ltd. (The), Toronto, Ont.  
Gutta Percha & Rubber Mfg. Co. Ltd., Toronto, Ont. *See back cover.*

**77—BALLS—leather, Cricket and Foot.**

Sale & Marlatt, Oakville, Ont.

**78—BALLS—Billiard and Pool.**

Reid Bros. Mfg. Co. Toronto, Ont.  
Ethier, E. L. & Co., Montreal.  
May, Samuel, Toronto, Ont.

**79—BALLS—Ten Pin.**

May Samuel & Co., Toronto, Ont.

Storey, D. Ottawa, Ont.  
Otterville Mfg. Co. Ltd., Otterville, Ont. *Advt. p. 259*

**80—BALLS—Stocking (Wood.)**

McLeod Bros. Truro, N. S.

**81—BALLS—(Brass) Ox.**

Chadwick Bros., Hamilton, Ont. *Advt. page 206*  
Peterborough Lock Mfg. Co., Peterborough, Ont. *Advt. page 219*

**82—BALM—Nasal.**

Fulford, G. T. & Co., Brockville, Ont.

**83—BALUSTERS.**

Ives, H. R. & Co., Montreal, Que. *Advt. page 200*  
Rathbun Co. (The), Deseronto, Ont. *Advt. page 162*  
Paquet & Godbout, Montreal & St. Hyacinthe, Que.  
Edwards, W.C. & Co. Ltd., Ottawa, Ont. *Advt. p. 219*

**84—BALUSTERS—Terra Cotta.**

Beamsville Pressed Brick Co., Beamsville, Ont.

**85—BANDS—Brass, Copper, Hub, Fire Hose.**

Garth & Co., Montreal, Que. *Advt. page 154*  
Chadwick Bros., Hamilton, Ont. *Advt. Page 206*  
Hamilton Brass Mfg. Co., Hamilton, Ont. *Advt. p. 168*  
Coulter & Campbell, Toronto, Ont. *Advt. page 201*  
Mitchell, Robt. & Co., Montreal, Que. *Advt. p. 213*  
American Copper Co., Toronto, Ont. *Advt. p. 157*  
Booth Copper Co. (The), Toronto, Ont. *Advt. p. 155*  
Parker, J. O. & Co., Toronto, Ont. *Advt. page 253*

**86—BANDS—(Iron) Carriage Hub.**

Smart, James Mfg. Co., Brockville, Ont. *Advt. p. 178*

**87—BANDS—(Veneere) Cheese Box.**

Acme Veneere Co., Orillia, Ont. *Advt. page 217*  
Toronto Hoop & Veneer Co., Toronto, Ont. *Advt. p. 234*

**88—BANDS—(Elastic) Web.**

Globe Suspender Co. (The), Rock Island, Que.

**89—BANDS—Electric.**

Dorenwend Electric Belt & Truss Co., Toronto, Ont.

**90—BANDS—Rubber—Elastic.**

Alpha Rubber Co. Ltd., Montreal, Que.  
Canadian Rubber Co., Montreal, Que. *Advt. page 197*

**91—BANDS—Cholera.**

Montreal Silk Mills Co. Ltd., Montreal, Que.

**92—BANDS—(Rubber) Interfering.**

Gutta Percha & Rubber Mfg. Co. Ltd., Toronto, Ont. *See back cover.*  
Toronto Rubber Co. Ltd. (The), Toronto, Ont.  
Canadian Rubber Co., Montreal, Que. *Advt. page 197*

**93—BANDAGES—Gum, Surgical, Elastic.**

Canadian Rubber Co., Montreal, Que. *Advt. page 197*  
Alpha Rubber Co. Ltd., Montreal, Que.

**94—BANDAGES,**

Cheese Merchants Mfg. Co., Montreal, Que.

**95—BANDAGES—Suspensory.**

Gross, F. Montreal, Que.

**96—BACKS—Wood, Brush.**

Kaufman, Jacob, Berlin, Ont.  
Hope, John, Lachute, Que. *Advt. page 188*

**97—BACKS—(Fire) Adjustable.**

Woodyatt, A. R. & Co., Guelph, Ont. *Advt. p. 207.*  
 Smart, (The James), Mfg. Co. Ltd., Brockville, Ont.  
*Advt. page 178.*

**98—BACKS—(Iron) Fire, Chimney.**

Carrier, Laine & Co., Levis, Que. *Advt. page 150.*  
 Smart, Mfg. Co. Ltd., Brockville, Ont. *Advt. page 178.*  
 Loignon, A. & E., Montreal, Que. *Advt. page 247.*

**99—BACKS—Iron, Sink.**

Smart, Mfg. Co. Ltd., Brockville, Ont. *Advt. page 178.*  
 Young & Bro. Co. Ltd. (The), Hamilton, Ont.  
*Advt. page 257.*

**100—BACKS—Tuyere, Iron.**

Carrier, Laine & Co., Levis, Que. *Advt. page 150.*  
 Gurney, Tilden & Co., Ltd., Hamilton, Ont. *Advt. p. 151.*  
 Smart Mfg. Co. Ltd., Brockville, Ont. *Advt. page 178.*  
 Jardine, A. B. & Co., Hespeler, Ont. *Advt. page 217.*  
 Matheson, I. & Co., New Glasgow, N. S. *Advt. p. 200.*

**101—BACKS—Seat, Water Closet.**

Gignac, O. & Fils, Quebec, Que.  
 Thackray, Robert, Ottawa, Ont.

**102—Backing and Backboards.**

Woltz & McMahon, Toronto, Ont. *Advt. page 203.*  
 Rathburn Co. (The), Deseronto, Ont. *Advt. p. 162.*  
 Toronto Hoop & Veneer Co., Toronto, Ont. *Advt. p. 234.*  
 Mathews Bros. & Co., Toronto, Ont.

**103—BAGS—(Leather) Cartridge, Hand, Mail, Saddle, School, Tourists', Travelling.**

Barrington, Geo. & Sons, Montreal, Que.  
 Borbridge, S. & H., Ottawa, Ont.  
 O'Shaughnessy, R. & Co., St. John, N. B.  
 Eveleigh, J. & Co., Montreal, Que.  
 Fournier & Boyer, Montreal, Que.

**104—BAGS—(Cotton), Flour, Grain, Mail, Ballast, Seed, Seamless, Burlap.**

Canada Jute Co., Ltd., Montreal, Que. *Advt. p. 225.*  
 Dominion Cotton Mills Co., Montreal, *Advt. p. 181.*  
 Leckie, J., Toronto, Ont.

**105—BAGS—(Coffee,) Hemp, Gunny, Ballast.**

Canada Jute Co. Ltd., Montreal, Que. *Advt. p. 225.*

**106—BAGS—(Cotton Duck,) Navy, Water-proof, Canvas.**

Sonne, Thomas, Montreal, Que.  
 Montreal Tent, Awning & Tarpaulin Co., Montreal,  
*Advt. page 232.*

**107—BAGS—Camp (Rubber).**

Toronto Rubber Co. Ltd. (The), Toronto, Ont.  
 Gutta Percha & Rubber Mfg Co. Ltd., Toronto,  
 Ont. *See back cover.*

**108—BAGS—(Rubber,) Bleeding, Face, Sponge, Throat, Toilet Brush.**

Alpha Rubber Co. Ltd., Montreal, Que.

**109—BAGS—Wool.**

Canada Jute Co. Ltd., Montreal, Que. *Advt. p. 225.*

**110—BAGGERS—Grain.**

Campbell, Manson, Chatham, Ont. *Advt. page 252.*  
 Sawyer & Massey Co. Ltd., Hamilton, Ont.

**111—BAGGING—Jute, Cunny, Cotton.**

Canada Jute Co. Ltd., Montreal, Que. *Advt. page 225.*  
 Dominion Cotton Mills Co., Montreal. *Advt. p. 181.*

**112—BADGES—(Metal,) Engraved, Brass, Bronze, Society.**

Pritchard & Andrews, Ottawa, Ont. *Advt. page 250.*  
 Rolph, Smith & Co., Toronto, Ont.  
 Patterson & Heward, Toronto, Ont. *Advt. page 201.*  
 Dawson, G. W., Montreal, Que.  
 Cox, E. & Co., Montreal, Que.  
 Cox, George, Ottawa, Ont.  
 Fell, I. C. & Co., Toronto, Ont.

**113—BADGES—Silk & Banners.**

White, C. J., Hamilton, Ont.  
 Dominion Regalia Co. (The), Toronto, Ont.

**114—BADGES—Gold & Silver.**

Ellis, P. W. & Co., Toronto, Ont.

**115—BADGES—Fireman's, Brass & Nickle.**

Garth & Co., Montreal, Que. *Advt. page 154.*  
 Hamilton Brass Mfg Co., Hamilton, Ont. *Advt. 163.*  
 Pritchard & Andrews, Ottawa, Ont. *Advt. page 250.*  
 Fell, I. C. & Co., Toronto, Ont.

**116—BAGS—Rubber Hat.**

Gutta Percha & Rubber Mfg. Co. Ltd., Toronto,  
 Ont. *See back cover.*  
 Canadian Rubber Co., Montreal, Que. *Advt. page 197.*

**117—BAGS—(Canvas,) Coal, School.**

Canada Jute Co. Ltd., Montreal, Que. *Advt. p. 225.*  
 Pike, D., Toronto, Ont. *Advt. page 182,*  
 Soper, R., Hamilton, Ont. *Advt. page 229.*  
 Sonne, Thos., Montreal, Que.  
 Montreal Tent, Awning & Tarpaulin Co., Montreal,  
 Que. *Advt. page 232.*

**118—BAGS—School, (Woven).**

Gendron Mfg Co. Ltd., Toronto, Ont., *Advt. p. 187.*

**119—BAGS—Paper, Banana, Millinery, Hatters', Shirt, Glove, Stationers', Broom, Grocers', Confectioners'.**

Eddy Co. Ltd. (The E. B.), Hull, Que.  
 Reid Bros. & Co., London, Ont.  
 Kilgour Bros., Toronto, Ont.  
 Taylor Bros., Toronto, Ont.  
 Wilson, J. C. & Co., Montreal, Que.

**120—BAIT—Tanners'.**

Canada Chemical Mfg Co., Ltd., London, Ont.

**121—BALANCES—Letter, Parcel.**

Pritchard & Andrews, Ottawa, Ont. *Advt. page 250.*

**122—BALCONIES—Iron.**

Carrier, Laine & Co., Levis, Que. *Advt. page 150.*  
 Dominion Ornamental Iron Co., Montreal, Que.  
 Loignon, A. & E., Montreal, Que. *Advt. page 247.*  
 Dennis Wire & Iron Works, London, Ont. *Ad. 207.*  
 Toronto Fence & Iron Works, Toronto, Ont.

**123—BALCONIES—Fire Escape.**

Toronto Fence & Ornamental Iron Works, Toronto,  
 Ont.  
 Ives, H. R. & Co., Montreal, Que. *Advt. page 200.*  
 Carrier, Laine & Co., Levis, Que. *Advt. page 150.*

**124—BALES—Kettle.**

Ives, H. R. & Co., Montreal, Que. *Advt. page 200.*

**125—BANGLES.**

Saunders, H. & A., Toronto, Ont.

**126—BANGS—Hair.**

Dorenwend Co. Ltd. (The), Toronto, Ont.

**127—BANJOS.**Whaley, Royce Piano Co. Ltd. (The), Toronto, Ont. *Advt. page 189.***128—BANKS—(Tin) Toy.**Davidson Mfg. Co. Ltd., Montreal, Que. *Advt. p. 225.***129—BANNISTERS & BALUSTRADES.**Gignac, O. & Fils, Quebec, Que.  
Storey, D., Ottawa, Ont.  
McLaughlin, J., Ottawa, Ont.**130—BANNOCKBURNS—Scotch.**

Humphrey, John A. &amp; Son, Moncton, N. B.

**131—BARK—Tan.**Price, H. M. & Co., Quebec, Que. *Advt. page 223.*  
King Bros., Quebec, Que. *Advt. page 240.*  
Ontario Bark Co. Ltd., Hepworth, Ont.  
Goodhue Bros., Danville, Que.  
Daigneau, J. M., Sherbrooke, Que.  
Church, Mitchell & Fee, Mitchell Station, Que.  
Godbout, Joseph, St. George de Windsor, Que.  
Sumner Co., Moncton, N. B.  
Fish, R. Y., Waterloo, Ont.**132—BARKS—Prepared, Cascara.**Stearns, Fred'k. & Co., Windsor, Ont. *See back cover.***133—BARROWS—Furnace Charging, Steel Tray, Coal, Foundry, Iron.**Carrier, Laine & Co., Levis, Que. *Advt. page 150.*  
Dennis Wire & Iron Co., London, Ont. *Advt. p. 207.***134—BARROWS—Steel, Wheel, Foundry, Mining, Tubular.**Ingersoll Rock Drill Co., Montreal, Que. *Advt. 198.*  
Morrison Brass Mfg Co., Toronto, Ont. *Advt. p. 157.*  
Carrier, Laine & Co., Levis, Que. *Advt. page 150.***135—BARLEY—Pot, Crushed Barley, Split Peas'.**Harper, George H., Dundas, Ont.  
Lawson Bros., Toronto, Ont.  
Galt Milling Co., Galt, Ont.  
Nairn, Stephen, Winnipeg, Man.  
Martin Bros., Mount Forrest, Ont.  
Snider, Wm. & Co., Waterloo, Ont.  
Caledonia Mills, Bomenville, Ont.  
Thompson, Walter, London, Ont.**136—BARS—Angle Iron, Angle Steel.**

Nova Scotia Steel Co. Ltd., New Glasgow, N. S.

**137—BAR—Antimony, Rabbitt.**

Langwell, George &amp; Son, Montreal, Que.

**138—BARS—Rocking Grate, "Heeson."**The Heeson Rocking Grate Bar Co., Toronto, Ont. *Advt. page 254.***139—BARS—(Vessel), Capstan.**Carrier, Laine & Co., Levis, Que. *Advt. page 150.***140—BARS—Clothes.**

Schultz Bros., Brantford, Ont.

**141—BARS—Draw.**

Nova Scotia Steel Co. Ltd., New Glasgow, N. S.

**142—BARS—Engine.**Laurie Engine Co., Montreal, Que. *Advt. page 179.*  
Whitman & Barnes Mfg Co., St. Catharines, Ont.**143—BARS—(Iron), Grate.**Carrier, Laine & Co., Levis, Que. *Advt. page 150.*  
Star Iron Co., Montreal, Que. *Advt. page 243.*  
Laurie Engine Co., Montreal, Que. *Advt. page 179.*  
Gurney Foundry Co. Ltd., Toronto, Ont.  
Nie & Whitfield, Hamilton, Ont.  
Garth & Co., Montreal, Que. *Advt. page 154.*  
Yves & Bro. Co., Hamilton, Ont. *Advt. page 257.*  
Ives, H. R. & Co., Montreal, Que. *Advt. page 200.*  
Brown, Mfg Co. Ltd., Belleville, Ont. *Advt. p. 198.***144—BARS—(Iron), Boiler Grate.**Goldie & McCulloch Co. Ltd., Galt, Ont. *Advt. p. 159.*  
Carrier, Laine & Co., Levis, Que. *Advt. page 150.*  
Brown, Mfg Co. Ltd., Belleville, Ont. *Advt. page 198.*  
Gardner, Robt. & Son, Montreal Que.  
Bertram, John & Sons, Dundas, Ont. *Advt. p. 161.*  
Garth & Co., Montreal, Que. *Advt. page 154.*  
Waring, White & Co., St. John, N. B. *Advt. p. 256.*  
Matheson, I. & Co., New Glasgow, N. S. *Advt. p. 200.*  
Jenckes Machine Co., Sherbrooke, Que. *Advt. p. 165.*  
Brush, Geo., Montreal, Que.  
Hamilton, Wm. Mfg Co. Ltd., Peterborough, Ont.**145—BARS—Mower & Reaper Cutter.**

Whiman &amp; Barnes Mfg Co., St. Catharines, Ont.

**146—BARS—Pinch & Crow, Tamping, Claw.**Ingersoll Rock Drill Co., Montreal, Que. *Advt. p. 198.*  
Warnock, James & Co., Galt, Ont.  
Canadian Rand Drill Co., Sherbrook, Ont. *Advt. 165.*  
Brown, Mfg Co. Ltd., Belleville, Ont. *Advt. p. 198.*  
Stewart, John, New Glasgow, N. S. *Advt. page 222.***147—BARS—Puddled.**

Londonderry Iron Co. Ltd. (The), Montreal, Que.

**148—BARS—(Iron), Shutter, Jail.**Garth & Co., Montreal, Que. *Advt. page 154.*  
Ives, H. R. & Co., Montreal, Que. *Advt. page 200.***149—BARS—Splice.**Nova Scotia Steel Co. Ltd., New Glasgow, N. S.  
Brown, Mfg Co. Ltd., Belleville, Ont. *Advt. p. 198.***150—BARS—(Ry.) Switch, Tie.**Canada Spring & Switch Co. Ltd., Montreal, Que. *Advt. page 217.*  
Brown, Mfg Co. Ltd., Belleville, Ont. *Advt. p. 198.*  
Stewart, John, New Glasgow, N. S. *Advt. page 222.***151—BARS—Metal Towel.**Ives, H. R. & Co., Montreal, Que. *Advt. page 200.***152—BARRELS—Half, Beer, Ale, Pork.**Thompson, S., Toronto, Ont.  
London & Petrolia Barrel Co., London, Ont.  
Butcher, F. E., St. Marys, Ont.  
Lendreville, J., Toronto, Ont.**153—BARYTA.**Lyman Sons & Co., Montreal, Que.  
Canada Paint Co. Ltd., Montreal, Que. *Advt. p. 221.***154—BASES—Lamp.**Lamont Glass Co., New Glasgow, N. S. *Advt. p. 231.*  
Diamond Glass Works, Montreal, Que.

**155—BASES—(Lamp), Slate.**

New Rockland Slate Co., Montreal, Que.

**156—BASES—Metal Lamp.**

Young & Bro. Co. Ltd., Hamilton, Ont. *Advt. p. 257.*  
Raymond. Charles, Guelph, Ont.

**157—BASES—Trolley.**

Ingersoll Rock Drill Co., Montreal, Que. *Advt. 198.*

**158—BASES—Vertical Boiler.**

Carrier, Laine & Co., Levis, Que. *Advt. page 150.*  
Brown, Mfg Co. Ltd., Belleville, Ont. *Advt. p. 198.*  
Jenckes Machine Co., Sherbrooke, Que. *Advt. p. 165.*  
Matheson, I. & Co., New Glasgow, N. S. *Advt. 200.*  
Gardner, Robt. & Son, Montreal, Que.

**159—BASKETS—(Wire), Card, Sponge, Flower, Moss, Hanging, Office.**

Dennis Wire & Iron Co., London, Ont. *Advt. p. 207.*  
Meadows, Geo. B., Toronto, Ont.  
Davidson, Mfg Co. Ltd., Montreal, Que. *Advt. p. 225.*

**160—BASKETS—Fruit, Berry, Grape, Peach, Strawberry, Grocers'.**

St. Catharines Box & Basket Co. Ltd., St. Catharines, Ont. *Advt. page 203.*  
Belleville Box & Basket Co. Ltd., (The), Belleville, Ont. *Advt. page 234.*  
Oakville Basket Co. Ltd., Oakville, Ont. *Advt. p. 234.*  
Ontario Basket Co. Ltd., Walkerville, Ont.  
Moore, H. H., Clarksburg, Ont.  
William, George H., Thorold, Ont.

**161—BASKETS—(Willow), Laundry, Lunch, Fancy, Bottle, Perfumery, Market, Work, Waste Paper.**

Pelosse, P., Montreal, Que. *Advt. page 234.*  
Watts, Charles, Toronto, Ont.  
Theissen, John, Toronto, Ont.

**162—BASKETS—Meat, Bushel, Root, Clothes.**

Oakville Basket Co., Oakville, Ont. *Advt. page 234.*

**163—BASKETS—Cane Bottle.**

Cork Co. of Canada Ltd., Toronto, Ont. *Advt. p. 187.*  
Pelosse, P., Montreal, Que. *Advt. page 234.*

**164—BASINS—(Wash), Copper, Brass.**

Garth & Co., Montreal, Que. *Advt. page 154.*  
American Copper Co. Toronto, Ont. *Advt. p. 157.*  
Booth Copper Co. Toronto, Ont. *Advt. page 155.*  
Mitchell, Robt. & Co., Montreal, Que. *Advt. p. 213.*  
Davidson Mfg Co. Ltd., Montreal, Que. *Advt. p. 225.*  
Coulter & Campbell, Toronto, Ont. *Advt. page 201.*  
Chadwick Bros., Hamilton, Ont. *Advt. page 206.*  
Parker, J. O. & Co., Toronto, Ont. *Advt. page 253.*

**165—BASINS—Lavatory, Plug, Earthen.**

Brantford Stoneware Mfg Co., Brantford, Ont. *Advt. page 251.*  
Dominion Sanitary Pottery Co., St. Johns, Que. *Advt. page 253.*  
St. Johns Stone & Chinaware Co., St. Johns, Que.  
Campbell & Purvis, St. Johns, Que.

**166—BASINS—Tin Wash.**

Chown, W. W. & Co., Belleville, Ont. *Advt. page 233.*  
Davidson Mfg Co. Ltd., Montreal, Que. *Advt. p. 225.*

**167—BASINS—Wash (Fibre ware).**

Eddy Co. Ltd., (The E. B.), Hull, P. Q.

**168—BASINS—Adjustable.**

Malcolm, W. B., Toronto, Ont.

**169—BATTING—Upholsters.**

Bauer, A. & Co., Waterloo, Ont. *Advt. page 185.*  
Duncan, W. S., Stratford, Ont.  
Pollock, W. C., Almonte, Ont.  
Smith, Wool Stock Co., Toronto, Ont.  
Robert, J. B., Beauharnois, Que.  
Shepherd, David, Almonte, Ont.  
New Toronto Wool Stock Co., New Toronto, Ont.  
Canada Garmenting Co., Montreal, Que.  
Carpenter, R. W., Moe's River, Que.  
Harding & Son, Simcoe, Ont.

**170—BATTING—Tow.**

Perine, M. B. & Co., Doon, Ont. *Advt. page 181.*

**171—BATTING—Cotton.**

Dominion Wadding Co. Ltd., Montreal. *Advt. 183.*

**172—BATTING—Mattress Makers', Wool.**

Bauer, A. & Co., Waterloo, Ont. *Advt. page 185.*

**173—BATTERIES—Storage.**

Kay Electric Mfg Co., Hamilton, Ont. *Advt. p. 233.*  
Ness, McLaren & Bate, Montreal, Que. *Advt. p. 240.*  
Ballard Electric Works (The), Toronto, Ont.  
Royal Electric Co., Montreal, Que.  
Canadian General Electric Co. Ltd., Toronto, Ont.  
Toronto Electrical Works, Toronto, Ont.

**174—BATTERIES—Blasting.**

Acadia Powder Co. Ltd., Halifax, N. S. *Advt. p. 240.*  
Starr, John, Son & Co., Halifax, N. S.  
Toronto Electrical Works, Toronto, Ont.

**175—BATTERIES—Galvanic, Electrode.**

Toronto Electrical Works, Toronto, Ont.

**176—BATTERIES—Medical.**

Kay Electric Mfg Co., Hamilton, Ont. *Advt. p. 233.*  
Toronto Electrical Works, Toronto, Ont.  
Ness, McLaren & Bate, Montreal, Que. *Advt. p. 240.*  
Royal Electric Co., Montreal, Que.  
Norman, A., Toronto, Ont.

**177—BATHS—(Glass), Bird.**

Lamont Glass Co., New Glasgow, N. S. *Advt. p. 231.*  
Diamond Glass Works, Montreal, Que.

**178—BATHS—(Iron), Copying Sheet, Blotter.**

Smart, Mfg Co. Ltd., Brockville, Ont. *Advt. p. 178.*

**179—BATHS—Steel Clad, (Booths Patent).**

Toronto Steel-Clad Bath & Metal Co. Ltd. (The), Toronto, Ont. *Advt. page 155.*

**180—BATHS—Portable.**

Toronto Steel Clad-Bath & Metal Co. Ltd. (The), Toronto, Ont. *Advt. page 155.*  
Garth & Co., Montreal, Que. *Advt. page 154.*

**181—BATHS—Porcelain.**

Dominion Porcelain Works (The), Iberville, Que.

**182—BATHS—(Tin), Infants, Foot, Hip.**

Davidson, Mfg Co. Ltd., Montreal, Que. *Advt. 225.*  
Wright, E. T. & Co., Hamilton, Ont.

**183—BATS—Base Ball.**

Strathroy, Mfg Co. Ltd. (The), Strathroy, Ont.  
Still, J. H., St. Thomas, Ont.

**184—BATHS—Cast Iron.**

Rodden, Win. & Co., Montreal, Que.

**185—BEADERS—Can, Cornice, Cutter, Stove, Pipe.**

Brown, Boggs & Co., Hamilton, Ont. *Advt. p. 193.*

**186—BEAMS—Cultivator, Plow.**

Chalifoux, O. & Sons, St. Hyacinthe, Que. *Advt. 232.*

**187—BEAMS—Scale.**

Gurney Scale Co., Hamilton, Ont. *Advt. page 244.*

**188—BEAMS—Steel, Iron.**

Stewart, John, New Glasgow, N. S. *Advt. page 222.*  
Dominion Bridge Co. Ltd., Montreal, Que. *Advt. 195.*  
Central Bridge & Engineering Co. Ltd., Peterboro,  
Ont. *Advt. page 214.*

**189—BEARINGS—Angle.**

Bertram, John & Sons, Dundas, Ont. *Advt. page 161.*  
Brush, Geo., Montreal, Que.

**190—BEARINGS—Anti-Friction, Self Oiling.**

Carrier, Laine & Co., Levis, Que. *Advt. page 150.*  
Matheson, I. & Co., New Glasgow, N. S. *Advt. 200.*  
Lancaster Machine Works, Lancaster, Ont. *Advt. 248.*  
Wilson, J. C. & Co., Glenora, Ont.

**191—BEARINGS—Bronze Journal, Car Journal.**

Rhodes, Curry & Co., Amherst, N. S. *Advt. p. 158.*  
Carrier, Laine & Co., Levis, Que. *Advt. page 150.*  
Crossen Car Mfg Co. Ltd., Cobourg, Ont. *Advt. 160.*  
Matheson, I. & Co., New Glasgow, N. S. *Advt. 200.*  
Garth & Co., Montreal, Que. *Advt. page 154.*

**192—BEARINGS—(Iron) Step-Angle, Journal.**

Bertram, John & Sons, Dundas, Ont. *Advt. p. 161.*  
Kerr & Morgan, Montreal, Que. *Advt. page 220.*  
Garth & Co., Montreal, Que. *Advt. page 154.*  
Miller Bros. & Toms, Montreal, Que. *Advt. p. 197.*  
Wilson, J. C. & Co., Glenora, Ont.

**193—BEARINGS—(Journal), Yielding.**

Prescott Emery Wheel Co. Ltd., Prescott, Ont.  
*Advt. page 237.*

**194—BEATERS—Egg.**

Ives, H. R. & Co., Montreal, Que. *Advt. page 200.*  
Davidson, Mfg Co. Ltd., Montreal, Que. *Advt. 225.*

**195—BEATERS—Wire Carpet.**

Otterville Mfg Co., Otterville, Ont. *Advt. p. 259.*  
Meadows, Geo. B., Toronto, Ont.

**196—BEATERS—Wood Pulp.**

Perkins, E. L., Ottawa, Ont.

**197—BEDS—(Rubber), Air, Rubbing.**

Alpha Rubber Co. Ltd., Montreal, Que.

**198—BEDS—(Slate), Billiard, Table.**

New Rockland Slate Co., Montreal, Que. *Advt. 244.*  
Canadian Granite Co. Ltd., Ottawa, Ont.  
Danville Asbestos & Slate Co., Danville, Ont.

**199—BEDS—Camp & Folding Camp.**

Otterville Mfg Co. Ltd., Otterville, Ont. *Advt. 259.*

Gale, Geo. & Sons, Waterville, Que. *Advt. page 258.*  
Cole's National Mfg Co., Ottawa, Ont.  
Elderkin, C. J., St. John, N. B.  
Snyder, Roos & Co'y., Waterloo, Ont.

**200—BEDS—Muff, Down, Feather.**

Alaska Feather & Down Co. Ltd., Montreal, Que.  
Thompson, D. W. & Co., Toronto, Ont.

**201—BEDS—Pit Lathe.**

Bertram, John & Sons, Dundas, Ont. *Advt. p. 161.*

**202—BEDS—(Spring), Folding.**

Gale, Geo. & Sons, Waterville, Que. *Advt. page 258.*  
Muaro Bros., New Glasgow, N. S. *Advt. page 244.*  
Hanover Spring Bed & Mattress Co., Hanover, Ont.  
Hutchings & Co., St. John, N. B.

**203—BEDS—Iron, Folding.**

Ives, H. R. & Co., Montreal, Que. *Advt. page 200.*

**204—BEDS—(Spring), Hospital.**

Gale, Geo. & Sons, Waterville, Que. *Advt. page 258.*

**205—BEDSTEADS—Brass.**

Gale, Geo. & Sons, Waterville, Que. *Advt. page. 258.*  
Ives, H. R. & Co., Montreal, Que. *Advt. page 200.*

**206—BEDSTEADS—Cabinet, Mantle, Ward-robe.**

Hanover Furniture & Undertaking Co. Ltd. (The),  
Hanover, Ont.  
Elderkin, C. J., St. John, N. B.  
Snider, John B., Waterloo, Ont. *Advt. page 231.*  
Hutchings & Co., St. John, N. B.

**207—BEDSTEADS—(Iron), Combination.**

Gale, Geo. & Sons, Waterville, Que. *Advt. page 258.*

**208—BEDSTEADS—(Iron), Hospital, Jail.**

Ives, H. R. & Co., Montreal, Que. *Advt. page 200.*  
Gale, Geo. & Sons, Waterville, Que. *Advt. page 258.*  
Chalifoux, O. & Sons, St. Hyacinthe, Que. *Advt. 232.*  
Dennis Wire & Iron Work, London, Ont. *Advt. 207.*  
Smart, Mfg Co. Ltd., Brockville, Ont. *Advt. p. 178.*  
Young & Bro. Co. Ltd., Hamilton, Ont. *Advt. 257.*

**209—BEDSTEADS—Wire.**

Meadows, Geo. B., Toronto, Ont.

**210—BEEF—(Staminal), Fluid.**

Johnston Fluid Beef Co., Montreal, Que. *Advt. 235.*

**211—BEEF—Corned, Dried.**

Clark, W., Montreal, Que.

**212—BEEF—Jelly (Mosquera), Liquid, Cocoa, Powdered, Meal.**

—BEEF—Iron & Wine.

Parke Davis & Co., Walkerville, Ont.

**213—BEER—Lager.**

Bajus, Phillip, Kingston, Ont.  
Bixell Brewing & Malting Co., Strathroy, Ont.  
Bixel, M. & Son, Brantford, Ont.  
Bernhardt, P., Preston, Ont.  
Colbert, Henry, Egmondville, Ont.  
Farquharson & Grainger, Walkerton, Ont.  
Compf, John, Hamilton, Ont.  
Grant-Lottridge Brewing Co., Hamilton, Ont.  
Huether, Chas., Waterloo, Ont.



Halliday, Thos., Guelph, Ont.  
Hergott Bros., Stratford, Ont.  
Kuntz, Louis, Waterloo, Ont.  
Kuntz, Henry, Hamilton, Ont.  
Kuntz, Jacob, Auburn, Ont.  
Lindberg, John, Halifax, N. S.  
Ottawa Brewing & Malting Co. Ltd., Ottawa, Ont.  
Reinhardt, G. & Sons, Montreal, Que.  
Roth, E. J., Listowell, Ont.  
Rudolph & Begg, St. Thomas, Ont.  
Reuter, Geo., Salem, Ont.  
Rau, Joseph, New Hamburg, Ont.  
Schwartz, John, Formosa, Ont.  
Sleeman, Geo., Guelph, Ont.  
Taylor & Bate, St. Catharines, Ont.  
Walkerville Brewing Co. Ltd., Walkerville, Ont.

**214—BELLS—Call, Magneto,**

Peterborough Lock Mfg Co., Peterborough, Ont.  
*Advt. page 219.*  
Mount Bros., Montreal, Que.  
Toronto Electrical Wrks, Toronto, Ont.  
Ness, McLaren & Bate, Montreal, Que. *Advt. p. 240.*

**215—BELLS—(Iron), Dumb.**

Brown, Boggs & Co., Hamilton, Ont. *Advt. page 193.*  
Gurney, Tilden Co. Ltd., Hamilton, Ont. *Advt. p. 151.*  
Peterborough Lock Mfg Co., Peterborough, Ont.  
*Advt. page 219.*  
Ives, H. R. & Co., Montreal, Que. *Advt. page 200.*  
Smart, Mfg Co. Ltd., Brockville, Ont. *Advt. p. 178.*  
Burrow, Stewart & Milne, Hamilton, Ont.

**216—BELLS—(Wood), Dumb.**

McLaughlin, J., Ottawa, Ont.  
Wesley, F. J., Toronto Junction, Ont.  
Thackray, R., Ottawa, Ont.  
McLeod Bros., Truro, N. S.  
Storey, D., Ottawa, Ont.  
Goulette, O. V., Gananoque, Ont. *Advt. page 214.*

**217—BELLS—Electric.**

Ness, McLaren & Bate, Montreal, Que. *Advt. p. 240.*  
Mount Bros., Montreal, Que.  
Bell Telephone Co. (The), Montreal, Que.  
Peterborough Lock Mfg Co., Peterborough, Ont.  
*Advt. page 219.*  
McAvity, T. & Sons, St. John, N. B. *Advt. p. 153.*  
Toronto Electrical Works, Toronto, Ont.

**218—BELLS—Factory, Ship, Fog, Steam-boat, Engine, School, Academy**

McAvity, T. & Sons, St. John, N. B. *Advt. p. 153.*  
Morrison-James Brass Mfg Co., Toronto, Ont.  
*Advt. page 157.*  
Garth & Co., Montreal, Que. *Advt. page 154.*  
Peterboro Lock Mfg Co., Peterboro Ont. *Advt. 219.*  
Macdonald & Co. Ltd., Halifax, N. S. *Advt. p. 256.*

**219—BELLS—(Glass), Smoke.**

Lamont Glass Co., New Glasgow, N. S. *Advt. p. 231.*

**220—BELLS—(Plated), Table.**

Simpson, Hall, Miller & Co., Montreal, Que.  
*Advt. page 203.*

**221—BELLS—(Brass), Telephone, Sheep, Hotel, Hand, Door, Cow, Farm, Call.**

Mitchell, Robt. & Co., Montreal, Que. *Advt. p. 213.*  
McAvity, T. & Sons, St. John, N. B. *Advt. p. 153.*  
Peterborough Lock Mfg Co., Peterborough, Ont.  
*Advt. page 219.*

**222—BELLS—Bicycle.**

Goold Bicycle Co. Ltd. Brantford, Ont. *Advt. p. 220.*

**223—BELLOWS — Blacksmiths, Foundry, Moulders.**

Forrester, Thos., Montreal, Que. *See front fly leaf.*  
Hamilton Facing Mill Co., Hamilton, Ont. *Advt. 193.*

**224—BELLOWS—Organ.**

Acme Veneer Works, Orillia, Ont. *Advt. page 217.*

**225—BELTS—Elastic.**

Dominion Suspender Co., Niagara Falls, Ont.  
Gross, F., Montreal, Que.

**226—BELTS—Electric.**

Norman, A., Toronto, Ont.  
Owen Electric Belt Co. (The), Toronto, Ont.  
Gross, F., Montreal, Que.

**227—BELTS—Ladies'.**

Dominion Suspender Co., Niagara Falls, Ont.  
Vroom, C. N., St. Stephens, N. B. *Advt. page 257.*  
Sale & Marlatt, Oakville, Ont.

**228—BELTS—Spun Metal.**

Chadwick Bros., Hamilton, Ont. *Advt. page 206.*

**229—BELTS—Bicycle Chain.**

Goold Bicycle Co. Ltd., Brantford, Ont. *Advt. p. 220.*

**230—BELTING—Cotton, Canvass, Rawhide Round, Duck.**

Canadian Rubber Co. (The), Toronto & Montreal,  
*Advt. page 197.*  
Gutta Percha & Rubber Mfg Co. Ltd., Toronto,  
Ont. *See back cover.*  
Forrester, Thos., Montreal, Que. *See front fly leaf*

**231—BELTING—(Leather), Link Leather, Oak Leather, Waterproof, Sewing Machine.**

McLaren Belting Co. (The J. C.), Montreal, Que.  
Porter Henry, Montreal, Que. *Advt. page 239.*  
Robin, Sadler & Haworth, Montreal, Que. *Advt. 226.*  
Goodhue, J. L. & Co., Danville, Que. *Advt. p. 236.*

**232—BELTING—Dicks Balata.**

Forrester, Thos., Montreal, Que. *See front fly leaf.*

**233—BELTING—(Rubber).**

Gutta Percha & Rubber Mfg Co. Ltd., Toronto, Ont.  
*See back cover.*  
Toronto Rubber Co. Ltd. (The), Toronto, Ont.  
Canadian Rubber Co., Montreal, Que. *Advt. p. 197.*

**234—BENCHES—Saddlers'.**

Goulette, O. V., Gananoque, Ont. *Advt. page 214.*

**235—BENCHES—Saw.**

Chalifoux, O. & Sons, St. Hyacinthe, Que. *Advt. 232.*

**236—BENCHES—Tub, Wringer.**

Smart Mfg Co. Ltd., Brockville, Ont. *Advt. page 178.*  
Cowan, O. D., Gananoque, Ont. *Advt. page 233.*  
Connor, J. H., Ottawa, Ont.

**237—BENCHES—Universal Saw.**

Goldie & McCulloch Co., Galt, Ont. *Advt. page 159.*  
MacGregor, Gourlay & Co., Galt, Ont.  
Cant Bros. (The) Co., *Advt. page 259.*

- Jackson, Cochrane & Co., Berlin, Ont.  
Ballantine, John & Co., Preston, Ont. *Advt. p. 205.*
- 238—BENDERS—Metal Cleat.**  
Brown, Boggs & Co., Hamilton, Ont. *Advt. p. 193.*
- 239—BENDERS—Tire.**  
Butterfield & Co., Rock Island, Que.  
Jardine, A. B. & Co., Hespeler, Ont. *Advt. page 217.*  
Smart Mfg Co. Ltd., Brockville, Ont. *Advt. p. 178.*
- 240—BENDERS—Improved Rail.**  
Canada Spring & Switch Co. Ltd., Montreal, Que. *Advt. page 217.*
- 241—BENDS—Brass, Copper.**  
Macdonald & Co. Ltd., Halifax, N. S. *Advt. p. 256.*  
Morrison, James, Brass Mfg Co. Ltd., Toronto, Ont. *Advt. page 157.*  
Coulter & Campbell, Toronto, Ont. *Advt. page 201.*  
Hamilton Brass Mfg Co., Hamilton, Ont. *Advt. 168.*  
Malcolm, W. B., Toronto, Ont.  
Booth Coper Co., Toronto, Ont. *Advt. page 155.*  
Parker, J. O. & Co., Toronto, Ont. *Advt. page 253.*  
Chadwick Bros., Hamilton, Ont. *Advt. page 206.*  
McAvity, T. & Sons, St. John, N. B. *Advt. p. 153.*  
American Copper Co., Toronto, Ont. *Advt. page 157.*
- 242—BENDS—Lead Pipe.**  
Montreal Rolling Mills Co. Ltd., Montreal, Que. *Advt. page 174.*  
Ontario Lead & Barb Wire Co. Ltd., Toronto, Ont. *Advt. page 177.*  
Robertson, (The James) Co. Ltd., Montreal & Toronto. *Advt. page 167.*  
Robertson, Thos. & Co., Montreal, Que.
- 243—BENDS—Cast Iron Pipe.**  
Drummond McCall, Pipe Foundry Co., Montreal, Que. *Advt. page 206.*  
Canada Pipe Foundry Co., Hamilton Ont.  
Three Rivers Iron Works, Three Rivers, Que.
- 244—BENDS—Malleable Iron Pipe.**  
Malleable Iron Co., Montreal, Que.  
Young Bros. Co. Ltd., Hamilton, Ont. *Advt. p. 257.*
- 245—BENDS—(Iron), Pipe, Return.**  
Three Rivers Iron Works, Three Rivers, Que. *Advt. page 179.*  
Canada Pipe Foundry Co., Hamilton, Ont.  
Toronto Foundry Co., Toronto, Ont.
- 246—BENZINE.**  
Imperial Oil Co. Ltd., Petrolia, Ont. *Advt. page 230.*
- 247—BENT WOODS'—Cutter Raves, Wheel Rims, Felloes, Spokes, Hubs, Buggy Shafts, Poles, Cutter Runners, Bob Sleigh Runners, Long Sleigh Runners, Wagon Hounds, Gear Stuff.**  
McVean, O. & W., Dresden, Ont.  
Longhead, J. S. & Co., Sarnia, Ont.  
Finlay, John & Son, Norwood, Ont.  
Canada Wheel Works, Merritton, Ont.  
Hore's, F. W. Sons, Hamilton, Ont.  
Victoria Wheel Works, Galt, Ont.  
Byram, E. A., Blenheim, Ont.
- 248—BIBBS—Rubber.**  
Alpha Rubber Co. Ltd., Montreal, Que.

- 249—BIBBS—Steam, Hose, Brass, Compression, Double Bath.**  
Garth & Co., Montreal, Que. *Advt. page 154.*  
McAvity, T. & Sons, St. John, N. B. *Advt. p. 153.*  
Morrison, James, Brass Mfg Co. Ltd., Toronto, Ont. *Advt. page 157.*  
Toronto Steel-Clad Bath & Metal Co. Ltd. (The), Toronto, Ont. *Advt. page 155.*  
Macdonald & Co. Ltd., Halifax, N. S. *Advt. p. 256.*  
Mitchell, Robert & Co., Montreal, Que. *Advt. 213.*  
Parker, J. O. & Co., Toronto, Ont. *Advt. page 253.*
- 250—BICYCLES—Men's, Women's.**  
Gendron Mfg Co. Ltd., Toronto, Ont. *Advt. p. 187.*  
Goold Bicycle Co. Ltd., Brantford, Ont. *Advt. 220.*  
Kingston Vehicle Co. Ltd., Kingston, Ont. *Advt. page 202.*  
Welland Vale Mfg Co., St. Catharines, Ont. *Advt. page 241.*  
American Rattan Co., Toronto, Ont.
- 251—BICYCLES—Safety, (High Grade).**  
Gendron Mfg Co. Ltd., Toronto, Ont. *Advt. p. 187.*
- 252—BICYCLES & TRICYCLES—Children's.**  
Gendron Mfg Co. Ltd., Toronto, Ont. *Advt. p. 187.*  
American Rattan Co., Toronto, Ont.
- 253—BINDERS—(Harvesters), Grain.**  
Moody, Matthew & Sons, Terrebonne, Que. *Advt. page 209.*  
Hamilton, Peter Mfg Co., Peterboro, Ont. *Advt. 209.*  
Noxon Bros. Mfg Co., Ingersoll, Ont.  
Maxwell, David & Sons, St. Mary's, Ont. *Advt. 250.*  
Frost & Wood, Smith's Falls, Ont.
- 254—BINDERS—Lath.**  
Canadian Locomotive & Engine Co. Ltd., Kingston, Ont. *Advt. page 175.*
- 255—BINDERS—Rail.**  
Brown Mfg Co. Ltd., Belleville, Ont. *Advt. p. 198.*
- 256—BINDERS—Steel Frame, Grain.**  
Hamilton, Peter Mfg Co., Peterboro, Ont. *Advt. 209.*
- 257—BINDING—Book.**  
Gage, W. J. (The) Co., Toronto, Ont. *Advt. p. 199.*  
Brown Bros. Ltd., Toronto, Ont.  
Morton, Phillips & Co., Montreal, Que.
- 258—BINDING—Carpet, Blanket.**  
Hamilton, Cotton Co., Hamilton, Ont. *Advt. p. 188.*
- 259—BINDING—"Frey's Patent", Book.**  
Manufacturing Stationers' Co. (The), Montreal, Que.
- 260—BINDING—"Kinnard's Patent", Book.**  
Morton, Phillips & Co., Montreal, Que.
- 261—BINDING—Oil Cloth.**  
Corticelli Silk Co. Ltd., St. Johns, Que. *Advt. 182.*  
Cascade Narrow Fabric Co. Coaticook, Que. *Advt. page 188.*
- 262—BINS—Ore.**  
Jenkes Mrchine Co., Sherbrooke, Que. *Advt. p. 165.*
- 263—BISCUITS—Fancy, Sweet, Soda, Sea.**  
Christie, Brown & Co., Toronto, Ont.  
McCormick Mfg Co. Ltd., London, Ont.  
Crothers, W. J., Kingston, Ont.

Abbott, Grant & Buell, Brockville, Ont.  
Toronto Biscuit & Confectionery Co., Toronto, Ont.  
Telfer Bros., Collingwood, Ont.  
Halifax Confectionery & Baking Co. Ltd., Halifax,  
N. S.

Hamilton, G. C. & Sons, Pictou N. S.  
Hamilton Biscuit & Confectionery Co., Hamilton,  
Ont.

Lang Mfg Co. (The), Montreal, Que.  
Gibson, W. G. & Son, Ottawa, Ont.  
Dupuis, A. B., Quebec, Que.

Luttrell, Joseph & Co., Montreal, Que.

Fletcher, C. H., Sherbrooke, Que.

Ballard & Fils, Quebec, Que.

Viau & Frere, Montreal, Que.

Moir, Son & Co., Halifax, N. S.

McLaughlan, J. & Son, Owen Sound, Ont.

Godin, J. N. & Co., Three Rivers, Que.

Hetrington, Thos., Quebec, Que.

Rankine, T. & Sons, St. John, N. B.

**264—BITS—Auger, Bell Hangers' Bung, Car,  
Caster, Countersink, Double Cut, Dowel,  
Expansion, Felloe, Gimlet, Lathe, Ma-  
chine, Plug, Pod.**

Gilmore, G., Cote St. Paul, Que.  
Gardner, W. R. Tool Co., Brockville, Ont.

**265—BITS—Reamer.**

Jardine, A. B. & Co., Hespeler, Ont. *Advt. p. 217.*

**266—BITS—Bridle.**

Martin Mfg Co., Whitby, Ont.

**267—BITS—Rubber.**

Canadian Rubber Co., Montreal, Que. *Advt. p. 197.*

**268—BITTERS—Dyspepsia, (Sharpe's.)**

Armstrong & Co., St. John, N. B. *Advt. page 229.*

**269—BITTERS—Orange, Tonic.**

Turner, Robert, Toronto, Ont.

**270—BLACKING—Shoe, Boot, Paste.**

McCrea & Hanes, Toronto, Ont. *Advt. page 248.*  
Domestic Specialty Co., Hamilton, Ont. *Advt. 227.*  
Pure Gold Mfg Co., Toronto, Ont.  
Edwards, C. M. & Co., Toronto, Ont.  
Dallay Co. Ltd. (F. F.), Hamilton, Ont.

**271—BLADDERS—Hog, Beef,**

Harris, W. & Co., Toronto, Ont.

**272—BLADES—(Saw), Band, Scroll, Wood.**

Robertson Co. Ltd. (Jas), Toronto, Ont. *Advt. p 167.*  
Smith, R. H. Co. Ltd., St. Catharines, Ont.  
Shurley & Dietrich, Galt, Ont.  
Burns Saw Co. (E. R.), Toronto, Ont.

**273—BLANKS—Key.**

Peterborough Lock Mfg Co., Peterborough, Ont.  
*Advt. page 219.*

Kyle, P., Merrickville, Ont.

Beaver Lock Works, Toronto, Ont.

Graham, T. & Sons, Toronto, Ont.

**274—BLANKS—Lithograph.**

Dominion Engraving Co., Ottawa, Ont. *Advt. p. 186.*  
Bishop Engraving & Printing Co., Montreal, Que.  
Rolph, Smith & Co., Toronto, Ont.  
Sabiston Lithograph & Engraving Co., Montreal.

Toronto Lithograph Co., Toronto, Ont.

Mortimer & Co., Ottawa, Ont.

Barkley, Clark & Co., Toronto, Ont.

**275—BLANKS—Lithographic.**

Ritchie & Ramsay, Toronto, Ont. *Advt. page 189.*

Union Card & Paper Co. Ltd. (The), Montreal, Que.  
*Advt. page 244.*

**276—BLANKS—(Printed), Railway, Com-  
mercial, Telegraph, Custom House.**

Gage, (W. J.) Co. Ltd., Toronto, Ont. *Advt. page 189.*

Allen, T. C. & Co., Halifax, N. S.

Mackinlay, A. & W., Halifax, N. S.

Morton, Phillips & Co., Montreal, Que.

Brown Bros. Ltd. (The), Toronto, Ont.

Manufacturing Stationers' Co., Montreal, Que.

Doust, Joseph, Toronto, Ont. *Advt. page 229.*

Mortimer & Co., Ottawa, Ont.

Fortier, Joseph, Montreal, Que.

Dominion Blank Form Pub. Co., Toronto, Ont.

**277—BLANKETS—(Rubber), Poncho, Army,  
Camp, Printers', Horse, Tent.**

Toronto Rubber Co. Ltd. (The), Toronto, Ont.

Canadian Rubber Co., Montreal, Que. *Advt. p. 197.*

**278—BLANKETS—Woolen, Bed, Union.**

Hodge, Wm., Cornwall, Ont.

Slingeby Bros., Brantford, Ont.

Ginrod, A. L., Sherbrook, Ont.

Oxford Mfg Co., Oxford, N. S.

Granite Mills Co., St. Hyacinthe, Que.

Waterhouse, Thos., Palmerston, Ont.

**279—BLEACH—Hair.**

Palmer, S., Montreal, Que.

Dorenwend Co. Ltd. (The), Toronto, Ont.

**280—BLIND—Window, Venetian, Sliding,  
Inside.**

Edwards, W. C. & Co. Ltd., Ottawa, Ont. *Advt. 219.*

Rathbun Co. (The), Deseronto, Ont. *Advt. page 162.*

Rhodes, Curry & Co. Ltd., Amherst, N. S. *Advt. 158.*

Robert, Jos. & Sons, Montreal, Que.

Gravel Lumber Co. Ltd., Etchemin, Que. *Advt. 215.*

Montreal Terra Cotta & Lumber Co., Montreal, Que.  
*Advt. page 214.*

Gilmour & Co., Trenton, Ont.

Paquet & Godbout, Montreal & St. Hyacinthe, Que.

Gignac, O. & Sons, Quebec, Que.

Schultz Bros., Brantford, Ont.

Dodd, J. G., London, Ont.

Ross, L. A., Cornwall, Ont.

**281—BLOCKS—Asphalt Paving.**

Edwards, W. C. & Co., Ottawa, Ont.

Reed, Geo. W., Montreal, Que. *Advt. page 237.*

Rathbun Co. (The), Deseronto, Ont. *Advt. p. 162.*

**282—BLOCKS—(Wood), Paving.**

Smith, J. F., Tara, Ont.

Morgan, J. D., Dundalk, Ont.

Victoria Harbor Lumber Co., Victoria Harbour, Ont.

**283—BLOCKS—Blacksmith Swage.**

Matheson, I. & Co., New Glasgow, N. S. *Advt. 200.*

Smart Mfg Co. Ltd., Brockville, Ont. *Advt. p. 178.*

Jardine, A. B. & Co., Hespeler, Ont. *Advt. p. 217.*

**284—BLOCKS—(Wood), Corner, Butchers'.**

Edwards, W. C. & Co. Ltd., Ottawa, Ont. *Advt. 219.*

**285—BLOCKS—(Wood), Wagon Head.**

Snider, Jesse, Hagerville, Ont.

**286—BLOCKS—(Wood), Dock, Ship.**

Beatty, M. & Sons, Welland, Ont. *Advt. page 173.*  
Jenckes Machine Co., Sherbrooke, Que. *Advt. 165.*  
Bradley Bros., St. John, N. B.

**287—BLOCKS—Telegraph, Side.**

Firstbrook Bros., Toronto, Ont.

**288—BLOCKS—Emery.**

Hart Emery Wheel Co. Ltd., Hamilton, Ont.  
*Advt. page 166.*

**289—BLOCKS — Engravers' (Maple, Box-wood).**

Campbell & Co., Toronto, Ont.

**290—BLOCKS—Furnace.**

Star Iron Co., Montreal, Que. *Advt. page 243.*

**291—BLOCKS—Fuse.**

Kay Electric Works, Hamilton, Ont. *Advt. p. 233.*

**292—BLOCKS—Gin.**

Brown Mfg Co. Ltd., Belleville, Ont. *Advt. p. 198.*

**293—BLOCKS—Hammer.**

Matheson, I. & Co., New Glasgow, N. S. *Advt. p. 200.*

**294—BLOCKS—(Hoisting), Iron, Wrought Iron, Hook, Snatch.**

Jenckes Machine Co. Ltd., Halifax, N. S. *Advt. 165.*  
Macdonald & Co. Ltd., Halifax, N. S. *Advt. p. 256.*  
Beatty, M. & Sons, Welland, Ont. *Advt. page 173.*

**295—BLOCKS—Match, (Pine).**

Hawkesbury Lumber Co. Ltd., Hawkesbury, Ont.  
New Jersey Match Co., Ottawa, Ont.

**296—BLOCKS—(Iron), Pillow.**

Myers, W. F. & J. W., St. John, N. B. *Advt. p. 163.*  
Robb Engineering Co. Ltd., Amherst, N. S.  
*See inside front cover.*  
Wilson, J. C. & Co., Glenora, Ont.  
Brown Mfg Co. Ltd., Belleville, Ont. *Advt. page 198.*

**297—BLOCKS—Prop, (Rubber).**

Gutta Percha & Rubber Mfg Co. Ltd., Toronto, Ont.  
*See back cover.*  
Canadian Rubber Co., Montreal, Que. *Advt. p. 197.*  
Toronto Rubber Co. Ltd. (The), Toronto, Ont.

**298—BLOCKS—Spring.**

Canada Spring & Switch Co., Montreal, Que.  
*Advt. page 217.*

**299—BLOCKS—Saw Mill Head.**

Goldie & McCulloch Co. Ltd., Galt, Ont. *Advt. 159.*  
Hamilton, Wm. Mfg Co. Ltd., Peterborough, Ont.  
Canadian Locomotive & Engine Co. Ltd., Kingston,  
Ont. *Advt. page 175.*  
Brush, Geo., Montreal, Que.

**300—BLOCKS—Saw Levelling.**

Ballantine, John & Co., Preston, Ont. *Advt. p. 205.*

**301—BLOCKS—Tint.**

Flewelling, C. H., St. John, N. B.

**302—BLOCKS—Wire Rope Pulley.**

Dominion Wire Rope Co. Ltd., Montreal, Que.  
*Advt. page 171.*

**303—BLOCKS—(Iron), Yacht, Tackle, Galvanized Pulley.**

Jenckes Machine Co., Sherbrooke, Que. *Advt. 165.*

**304—BLOOD—Dried Bullock's (Defibrinated).**

Parke, Davis & Co., Walkerville, Ont.

**305—BLOOMS—Iron.**

Canadian Locomotive & Engine Co. Ltd., Kingston,  
Ont. *Advt. page 175.*

**306—BLOUSES—Flannel & Cotton.**

Gale Mfg Co., Toronto, Ont.  
Braime, T. E. & Co., Toronto, Ont.  
Allen Mfg Co., Toronto, Ont.

**307—BLOWERS—Piston, Positive, Mining, Crank.**

Ingersoll Rock Drill Co., Montreal, Que. *Advt. 198.*  
Myers, W. F. & J. W., St. John, N. B. *Advt. p. 163.*

**308—BLOWERS — Pressure, Jet, Hand, Forge, Fan, Cupola, Blast.**

Myers, W. F. & J. W., St. John, N. B. *Advt. p. 163.*  
Field, Charles, Toronto, Ont.

**09—BLUING—Liquid.**

Pure Gold Mfg Co., Toronto, Ont.  
Pugsley, Dingman & Co., Toronto, Ont.  
Bradshaw, W. A. & Co., Toronto, Ont.  
Tellier, Rothwell & Co., Montreal, Que.

**310—BOARDS—Cheese, Pastry.**

Acme Veneer Works, Orillia, Ont. *Advt. page 217.*  
Toronto Hoop & Veneer Co., Toronto, Ont. *Advt. 234.*  
Wesley, F. J. & Co., Toronto Junction, Ont.

**311—BOARDS—(Paper), Chromo, Calendar, Fan, Tinted Folding Box, Fine & Superfine, Photo, Mount**

Ritchie & Ramsay, Toronto, Ont. *Advt. page 189.*

**312—BOARDS—Cloth, Cooling.**

Edwards, W. C. & Co. Ltd., Ottawa, Ont. *Advt. 219.*

**313—BOARDS — Cribbage, Chess, Checker, Game, Drawing.**

Tees & Co., Montreal, Que. *Advt. page 225.*

**314—BOARDS—Drawing.**

Tees & Co., Montreal, Que.

**315—BOARDS—Ironing, Skirt, Lap, Laundry.**

Storey Washing Machine Co. Ltd., Ottawa, Ont.  
Wesley, F. J. & Co., Toronto Junction Ont.

**316—BOARDS—(Mill), Asbestos.**

Sclater Asbestos Mfg Co., Montreal, Que. *Advt. 172.*  
Berry, M. B., Quebec, Que.  
Hopper, R. T. & Co., Montreal, Que. *Advt. p. 239.*  
Dominion Leather Board Co., Montreal, Que.

**317—BOARDS—Piano Key.**

Rathbun Co. (The), Deseronto, Ont. *Advt. page 162.*  
Toronto Keyboard Co. (The), Toronto, Ont.

- Kilgour Piano & Organ Co., Hamilton, Ont.  
Loose, Joseph M., Toronto, Ont.
- 318—BOARDS—(Wood), Wash.**  
Cane & Sons Mfg Co. Ltd. (The Wm.), Newmarket, Ont. *Advt. page 218.*  
Flewelling Mfg Co. (The G. & G.), Hamilton, N. B.
- 319—BOARDS—Slate, Black.**  
New Rockland Slate Co., Montreal, Que. *Advt. 224.*
- 320—BOARDS—Straw, Paper Box, Pulp.**  
Ford, J. & Co., Portneuf Station, Que. *Advt. p. 191.*  
Miller Bros. & Co., Montreal, Que. *Advt. page 192.*
- 321—BOARDS—(Switch), Electric Light, Telephone, Electric Railway.**  
Ness, McLaren & Bate, Montreal, Que. *Advt. p. 240.*  
Kay Electric Works, Hamilton, Ont. *Advt. page 233.*  
Canadian General Electric Co. Ltd., Toronto, Ont.  
Royal Electric Co., Montreal, Que.  
Starr, John, Son & Co., Halifax, N. S.  
Toronto Electrical Works, Toronto, Ont.
- 322—BOARDS—(Lumber), See Pine Lumber.**
- 323—BOARDS—Stove.**  
Davidson Mfg Co. (Thos.), Montreal, Que. *Advt. 225.*  
Kemp Mfg Co., Toronto, Ont.
- 324—BOATS—Bark.**  
Dumas, Raphael, Indian Lorette, Que.  
GrosLouis, Francis, Indian Lorette, Que.  
Paul, Thomas, Indian Lorette, Que.  
Sioui, Morice, Indian Lorette, Que.
- 325—BOATS—Veneer, St. Lawrence, Row, Hunting, Yacht.**  
Knapp, A. C., Kingston, Ont. *Advt. page 229.*  
Gilbert Boat Co., Brockville, Ont. *Advt. page 254.*  
English Canoe Co. (The Wm.), Peterboro, Ont.
- 326—BOATS—(Steam), Late & River, Ferry.**  
Matheson, I. & Co., New Glasgow, N. S. *Advt. 200.*  
Rathbun Co. (The), Deseronto, Ont. *Advt. p. 162.*  
Bertram Engine Works Co. Ltd., Toronto, Ont.  
Burrell-Johnson Iron Co., Yarmouth, N. S.
- 327—BOATS—Cruising, Sail, Club Working.**  
Canadian Canoe Co. Ltd., Peterboro, Ont.
- 328—BOATS—Lumber.**  
Cockburn, Jno & Son, Pembroke, Ont.
- 329—BOATS—Metallic Life.**  
McKelvey & Birch, Kingston, Ont. *Advt. p. 228.*
- 330—BOATS—Tow & Tug.**  
Carrier, Laine & Co., Levis, Que. *Advt. page 150.*  
Matheson, I. & Co., New Glasgow, N. S. *Advt. 200.*  
Burrell-Johnson Iron Co., Yarmouth, N. S.  
Canada Marine Works, Montreal, Que.  
Bertram Engine Works Co. Ltd., Toronto, Ont.
- 331—BOBS—Brass, Plumb.**  
Smart Mfg Co. Ltd., Brockville, Ont. *Advt. page 178.*  
Forster, Jas., Toronto, Ont.
- 332—BOBBINS—(Cotton & Woollen Mills), Warp, Filling, Spool, Roving, Web.**  
Hope, John, Lachute, Que. *Advt. page 188.*
- Hambleton & Co., Hampton, N. B.  
Thompson & Co., Sherbrooke, Que. *Advt. p. 228.*
- 333—BODIES—Children Carriage.**  
Gendron Mfg Co. Ltd., Toronto, Ont. *Advt. p. 187.*
- 334—BODIES—(Carriage), in the White.**  
Brooks, Jas. & Co., London, Ont.  
Simpson, I. & Co., Brantford, Ont.  
Goulette, O. V., Cananoque, Ont. *Advt. page 214.*
- 335—BOILERS & ENGINES—Cheese & Butter Factory.**  
Vessot, S. & Co., Joliette, Que. *Advt. page 238.*  
Lancaster Machine Works, Lancaster, Ont. *Advt. page 247.*  
Brown Mfg Co. Ltd., Belleville, Ont. *Advt. p. 198.*  
Waring, White & Co., St. John, N. B. *Advt. p. 256.*  
Carrier, Laine & Co., Levis, Que. *Advt. page 150.*  
Jenckes Machine Co., Sherbrooke, Que. *Advt. p. 165.*  
Richardson & Webster, St. Mary's, Ont.  
Pontbriant & Bro., Sorel, Que.
- 336—BOILERS—Cornish.**  
Carrier, Laine & Co., Levis, Que. *Advt. page 150.*  
Jenckes Machine Co., Sherbrooke, Que. *Advt. p. 165.*  
Patterson, John, Halifax, N. S. *Advt. page 194.*  
Brush, Geo., Montreal, Que.
- 337—BOILERS—Farm & Engines, (Threshing), Portable.**  
Sawyer & Massey Co. Ltd., Hamilton, Ont.  
Laurie Engine Co., Montreal, Que. *Advt. page 179.*  
Canadian Locomotive & Engine Co. Ltd., Kingston, Ont. *Advt. page 175.*  
Jenckes Machine Co., Sherbrooke, Que. *Advt. p. 165.*  
Brown Mfg Co. Ltd., Belleville, Ont. *Advt. page 198.*  
Carrier, Laine & Co., Levis, Que. *Advt. page 150.*  
Leonard, E. & Sons, London, Ont.
- 338—BOILERS—Farmers'.**  
Carrier, Laine & Co., Levis, Que. *Advt. page 150.*  
Gurney, Tilden Co. Ltd., Hamilton, Ont. *Advt. 151.*  
Gowdy Mfg Co., Guelph, Ont.  
Joliette Foundry Co., Joliette, Que.  
Entreprise Foundry Co. (The), Sackville, N. B.
- 339—BOILERS—Flue.**  
Goldie & McCulloch Co. Ltd., Galt, Ont. *Advt. p. 159.*  
Patterson, John, Halifax, N. S., *Advt. page 194.*  
Carrier, Laine & Co., Levis, Que. *Advt. page 150.*  
Jenckes Machines Co., Sherbrooke, Que. *Advt. p. 165.*  
Brown Mfg Co. Ltd., Belleville, Ont. *Advt. p. 198.*  
Brush, Geo., Montreal, Que.
- 340—BOILERS—"Hazleton."**  
Canadian Locomotive & Engine Co. Ltd., Kingston, Ont. *Advt. page 175.*
- 341—BOILERS—Horizontal, Marine, Portable, Stationery, Steam, Steel, Tubular, Vertical, Yacht.**  
Bertram Engine Works Co. Ltd., Toronto, Ont.  
Babcock & Wilcox Co., Montreal, Que. *Advt. p. 194.*  
Burrell-Johnson Iron Co., Yarmouth, N. S.  
Canadian Locomotive & Engine Co. Ltd., Kingston, Ont. *Advt. page 195.*  
Carrier, Laine & Co., Levis, Que. *Advt. page 150.*  
Jenckes Machine Co., Sherbrooke, Que. *Advt. p. 165.*  
Waterous Engine Works Co. Ltd., Brantford, Ont.  
White, W. C. Boiler Works, Montreal, Que.

Matheson, I. & Co., New Glasgow, N. S. *Advt.* 200.  
Patterson, John, Halifax, N. S., *Advt.* page 194.  
Flemming, James, St. John, N. B.  
Goldie & McCulloch Co. Ltd., Galt, Ont. *Advt.* 159.  
Hamilton, Wm. Mfg Co. Ltd., Peterborough, Ont.  
Leonard, E. & Sons, London, Ont.  
Nie & Whitfield, Hamilton, Ont.  
Brown Mfg Co. Ltd., Belleville, Ont. *Advt.* p. 198.  
Robb Engineering Co. Ltd., Amherst, N. S.

*See inside front cover.*

Mac Machine Co., Belleville, Ont. *Advt.* page 194.  
Wilson, J. C. & Co., Glenora, Ont.  
Macdonald & Co. Ltd., Halifax, N. S. *Advt.* p. 256.  
Brush, Geo., Montreal, Que.

### 342—BOILERS—Locomotive.

Canadian Locomotive & Engine Co. Ltd., Kingston, Ont. *Advt.* page 175.  
Carrier, Laine & Co., Levis, Que. *Advt.* page 150.  
Goldie & McCulloch Co. Ltd., Galt, Ont. *Advt.* 159.  
Mac Machine Co., Belleville, Ont. *Advt.* page 194.  
Robb Engineering Co. Ltd., Amherst, N. S.

*See inside front cover.*

Brown Mfg Co. Ltd., Belleville, Ont. *Advt.* page 198.  
Leonard, E. & Sons, London, Ont.  
Matheson, I. & Co., New Glasgow, N. S. *Advt.* 200.

### 343—BOILERS—Oil Fuel.

Carrier, Laine & Co., Levis, Que. *Advt.* page 150.  
Gillies, John & Co., Carleton Place, Ont.

### 344—BOILERS—(Copper), Ran "Resisto."

Booth Copper Co., Toronto, Ont. *Advt.* page 155.

### 345—BOILERS—Range (Copper & Brass).

Coulter & Campbell, Toronto, Ont. *Advt.* page 201.  
American Copper Co. Toronto, Ont. *Advt.* page 157.  
Booth, Copper Co., Toronto, Ont. *Advt.* page 155.  
Garth & Co., Montreal, Que. *Advt.* page 154.  
Gurney, Tilden Co. Ltd., Hamilton, Ont. *Advt.* 151.  
Parker, J. O. & Co., Toronto, Ont. *Advt.* page 253.

### 346—BOILERS—Range (Hot Water), Galvanized Iron.

Morrison, (James), Brass Mfg Co. Ltd., Toronto, Ont. *Advt.* page 157.  
Dominion Safe & Steel Range Works, Montreal, Que.  
Fraser Bros., New Glasgow, N. S. *Advt.* page 252.  
Rodden, Wm. & Co., Montreal, Que.  
Macdonald (The Thos.), Mfg Co., Montreal, Que.

### 347—BOILERS—Sectional.

Macdonal & Co. Ltd., Halifax, N. S. *Advt.* page. 256.

### 348—BOILERS—"Star."

Star Iron Co., Montreal, Que.

### 349—BOILERS—(Steam, "Monarch," Monarch Economic.

Robb Engineering Co. Ltd., Amherst, N. S.

*See inside front cover.*

### 350—BOILERS—Straw-Burning.

Jenckes Machine Co., Sherbrooke, Que. *Advt.* p. 165.  
Carrier, Laine & Co., Levis, Que. *Advt.* page 150.  
Canadian Locomotive & Engine Co. Ltd., Kingston, Ont. *Advt.* page 175.  
Robb Engineering Co. Ltd., Amherst, N. S.

*See inside front cover.*

Babcock & Wilcox Co., Montreal, Que. *Advt.* p. 194.

### 351—BOILERS—(Tubular), Vertical, Horizontal, Steel, Marine.

Goldie & McCulloch Co. Ltd., Galt, Ont. *Advt.* 159.  
Brown Mfg Co. Ltd., Belleville, Ont. *Advt.* p. 198.  
Beatty, M. & Sons, Welland, Ont. *Advt.* page 173.  
Robb Engineering Co. Ltd., Amherst, N. S.

*See inside front cover.*

Brush, Geo., Montreal, Que.

### 352—BOILERS—Wash (Copper),

Gurney, Tilden Co. Ltd., Hamilton, Ont. *Advt.* 151.  
Booth Copper Co., Toronto, Ont. *Advt.* page 155.  
American Copper Co., Toronto, Ont. *Advt.* page 157.  
Chadwick Bros., Hamilton, Ont. *Advt.* page 206.  
Chown, W. W. & Co., Belleville, Ont. *Advt.* p. 233.  
Coulter & Campbell, Toronto, Ont. *Advt.* p. 201.  
Parker, J. O. & Co., Toronto, Ont. *Advt.* page 253.

### 353—BOILERS—Water Tube.

Robb Engineering Co. Ltd., Amherst, N. S.

*See inside front cover.*

Brown Mfg Co. Ltd., Belleville, Ont. *Advt.* p. 178.  
Babcock & Wilcox, Montreal, Que. *Advt.* page 194.  
Patterson, John, Halifax, N. S. *Advt.* page 194.  
Jenckes Machine Co., Sherbrooke, Que. *Advt.* p. 165.  
White, (W. C.), Boiler Works, Montreal, Que.  
Bertram Engine Works Co. Ltd., Toronto, Ont.  
Brush, Geo., Montreal, Que.

### 354—BOILERS—Welded Steam.

Carrier, Laine & Co., Levis, Que. *Advt.* page 150.  
Bertram Engine Works Co. Ltd., Toronto, Ont.

### 355—BOILERS—(Coil), Heating, Hot Water.

Babcock & Wilcox Co., Montreal Que. *Advt.* p. 194.  
Carrier, Laine & Co., Levis, Que. *Advt.* page 150.  
Goldie & McCulloch Co., Galt, Ont. *Advt.* p. 155.  
Fraser Bros., New Glasgow, N. S. *Advt.* page 252.  
Jenckes Machine Co., Sherbrooke, Que. *Advt.* p. 165.  
Robb Engineering Co. Ltd., Amherst, N. S.

*See inside front cover.*

Truro Foundry & Machine Co., Truro, N. S.

*Advt.* page 198.

### 356—BOLTS—Brass.

Garth & Co., Montreal, Que. *Advt.* page 154.  
Coulter & Campbell, Toronto, Ont. *Advt.* page 201.  
Morrison (James) Brass Mfg Co. Ltd., Toronto, Ont.

*Advt.* page 157.

Hamilton Brass Mfg Co., Hamilton, Ont. *Advt.* 168.

### 357—BOLTS—Bridge.

Swansea Forging Co. Ltd., Swansea, Ont. *Advt.* 156.  
Stewart, John, New Glasgow, N. S. *Advt.* page 222.  
Matheson, I. & Co., New Glasgow, N. S. *Advt.* 200.  
Central Bridge & Engineering Co. Ltd., *Advt.* 214.  
Starr Mfg Co. Ltd., Halifax, N. S. *Advt.* page 199.  
Dominion Bridge Co. Ltd., Montreal, Que. *Advt.* 195.  
Dennis Wire & Iron Works, London, Ont. *Advt.* 207.

### 358—BOLTS—Bronze, Copper.

Coulter & Campbell, Toronto, Ont. *Advt.* page 201.  
Macdonald & Co. Ltd., Halifax, N. S. *Advt.* page 256.  
Gurney, Tilden Co. Ltd., Hamilton, Ont. *Advt.* 151.  
Peterboro Lock Mfg Co., Peterboro, Ont. *Advt.* 219.  
Garth & Co., Montreal, Que. *Advt.* page 154.

### 359—BOLTS—Button Head, Stove, Wagon, Loom, Tire, Hame, Track, Fancy Head, Drift.

Gillies, Geo. Co. Ltd., Gananoque, Ont. *Advt.* 156.  
Starr Mfg Co. Ltd., Halifax, N. S. *Advt.* page 199.

- Canada Screw Co., Hamilton, Ont. *Advt. page 220.*  
Swansea Forging Co. Ltd., Swansea, Ont. *Advt. 156.*  
Ives, H. R. & Co., Montreal, Que. *Advt. page 200.*
- 360—BOLTS—Carriage, Coupling, Key, Blank.**  
Swansea Forging Co. Ltd., Swansea, Ont. *Advt. 156.*  
Gillies (The Geo.), Co., Gananoque, Ont. *Advt. 156.*
- 361—BOLTS—(Carriage), "Prize," "Eclipse," "Superb."**  
Swansea Forging Co. Ltd., Swansea, Ont. *Advt. 156.*
- 362—BOLTS—Coil.**  
Young & Bro. Co. Ltd., Hamilton, Ont. *Advt. p. 257.*
- 363—BOLTS—King, Eye.**  
Gillies (The Geo.), Co., Gananoque, Ont. *Advt. 156.*
- 364—BOLTS—Cone Steeple, Acorn Head.**  
Skinner & Co., Gananoque, Ont. *Advt. page 255.*
- 365—BOLTS—Cone Head, Rag, Step, Elliptic Perch, Skein, Deck, Shaft, Elevator, Guard, Whiffletree.**  
Swansea Forging Co. Ltd., Swansea, Ont. *Advt. 156.*
- 366—BOLTS—Joint, Plow, Fish Plate, Car.**  
Starr Mfg Co. Ltd., Halifax, N. S. *Advt. page 199.*  
Gillies (The Geo.), Co., Gananoque, Ont. *Advt. 156.*  
Swansea Forging Co., Swansea, Ont. *Advt. p. 156.*
- 367—BOLTS—Machine.**  
Swansea Forging Co., Swansea, Ont. *Advt. p. 156.*  
Morrow, (John), Machine Screw Co., Ingersoll, Ont. *Advt. page 260.*  
Ives, H. R. & Co., Montreal, Que. *Advt. page 200.*
- 368—BOLTS—Patent Rolled Stove.**  
Canada Screw Co., Hamilton, Ont. *Advt. page 226.*
- 369—BOLTS—Planer, Boiler Patch, Stud.**  
Morrow, (John), Machine Screw Co., Ingersoll, Ont. *Advt. page 260.*
- 370—BOLTS—Sleigh Shoe.**  
Ives H. R. & Co., Montreal, Que. *Advt. page 200.*  
Canada Screw Co., Hamilton, Ont. *Advt. page 226.*  
Gillies Co. (Geo.) Ltd., Gananoque, Ont. *Advt. 156.*
- 371—BOLTS—Square Cased.**  
Peterboro Lock Mfg Co., Peterboro, Ont. *Advt. p. 219.*  
Smart, (Jas.) Mfg Co., Brockville, Ont. *Advt. p. 178.*
- 372—BOLTS—Spring Bar.**  
Skinner & Co., Gananoque, Ont. *Advt. page 255.*  
Smart, (Jas.) Mfg Co., Brockville, Ont. *Advt. p. 178.*
- 373—BOLTS—Carriage, Mortice, Square.**  
Ives, H. R. & Co., Montreal, Que. *Advt. page 200.*
- 374—BOLTS—Spring, Extension Flush, Cup-board, Door.**  
Peterboro Lock Mfg Co., Peterboro, Ont. *Advt. p. 219.*  
Swansea Forging Co. Ltd., Swansea, Ont. *Advt. 156.*  
Smart, (Jas.) Mfg Co., Brockville, Ont. *Advt. p. 178.*  
Ives, H. R. & Co., Montreal, Que. *Advt. page 200.*
- 375—BOLTS—Bicycle.**  
Morrow, (John) Machine Screw Co., Ingersoll, Ont. *Advt. page 260.*

**376—BOLTS—Tap.**

- Canada Screw Co., Hamilton, Ont. *Advt. page 226.*  
Morrow, (John) Machine Screw Co., Ingersoll, Ont. *Advt. page 260.*  
Gillies Co. (Geo.) Ltd., Gananoque, Ont. *Advt. 156.*  
Swansea Forging Co. Ltd., Swansea, Ont. *Advt. 156.*

**377—BOLTERS—Shingle.**

- Waring, White & Co., St. John, N. B., *Advt. p. 256.*  
Canadian Locomotive & Engine Co., Kingston, Ont. *Advt. page 175.*

**378—BOLTERS—Lath.**

- Goldie & McCulloch Co. Ltd., Galt, Ont. *Advt. 159.*  
Waring, White & Co., St. John, N. B. *Advt. p. 256.*  
Robb Engineering Co. Ltd., Amherst, N. S. *See inside front cover.*  
Canadian Locomotive & Engine Co., Kingston, Ont. *Advt. page 175.*

**379—BONE—Powdered.**

- Parke, Davis & Co., Walkerville, Ont.

**380—BONES—Dress.**

- Crompton Corset Co., Toronto, Ont.  
Thorp, G. A. Mfg Co., Toronto, Ont.

**381—BONNETS—Smoke Stack.**

- Robb Engineering Co. Ltd., Amherst, N. S. *See inside front cover.*

**382—BOOKS—Dictation.**

- Gage, (W. J.) Co. Ltd., Toronto, Ont. *Advt. p. 189.*

**383—BOOKS—Band Music.**

- Whaley, Royce Piano Co., Toronto, Ont. *Advt. 189.*

**384—BOOKS—Letter Copying, Invoice, Memorandum, Blank Account, Business College, Pass, Cash, Composition, Draft, Note, Cheque, Record, Day, Scrap, Order, Ledger, Journal, Pocket, Scribbling, Special Order.**

- Gage, (W. J.) Co. Ltd., Toronto, Ont. *Advt. p. 189.*  
Rolland Paper Co., Montreal, Que. *Advt. page 189.*  
Brown Bros. Ltd. (The), Toronto, Ont.  
McMillan, J. & A., St. John, N. B.  
Morton, Phillips & Co., Montreal, Que.  
Mortimer & Co., Ottawa, Ont.  
Allen, T. C. & Co., Halifax, N. S.  
Mackinlay, A. & W., Halifax, N. S.

**385—BOOKS—Music, Sheet Music, Musical Publications.**

- Whaley, Royce Piano Co., Toronto, Ont. *Advt. 189.*  
Nordheimer, A. & S., Toronto, Ont.

**386—BOOKS—School Writing.**

- Gage, (W. J.) Co. Ltd., Toronto, Ont. *Advt. p. 189.*  
Morton, Phillips & Co., Montreal, Que.  
Brown Bros. Ltd. (The), Toronto, Ont.  
Rolland Paper Co., Montreal, Que. *Advt. page 189.*  
Mackinlay, A. & W., Halifax, N. S.  
Allen, T. C. & Co., Halifax, N. S.  
Fortier, Joseph, Montreal, Que.

**387—BOOKS—Transit, Level, (Surveyors').**

- Allen, T. C. & Co., Halifax, N. S.

**388—BOOKS—Counter Check.**

- Reid Bros. & Co., London, Ont.



- Carter & Co. Ltd., Toronto, Ont.  
Manufacturing Stationers Co., Montreal, Que.
- 389—BOOTS—Felt.**  
Canadian Rubber Co., Montreal, Que. *Advt. p. 197.*  
Berlin Felt Boot Co. (The), Berlin, Ont.  
Ames, Holden & Co., Montreal, Que. *Advt. p. 228.*
- 390—BOOTS—Felt Lined.**  
Berlin Felt Boot Co. (The), Berlin, Ont.  
Seguin, Lalime & Co., St. Hyacinthe, Que.
- 391—BOOTS—(Leather), Horse Interfering.**  
Morgan Bros., Hamilton, Ont.  
Borbridge, S. & H., Ottawa, Ont.
- 392—BOOTS—Hunting, Lumbermens', Long Leg, Log Drivers, Miners'. Skating, Workmens, Fishing.**  
Ames, Holden & Co. Ltd., Montreal, Que. *Advt. 228.*  
Foster, A. T. & Co., Rock Island Que.  
Standard Boot Co. Ltd. (The), Quebec, Que.  
Amherst Boot & Shoe Co., Amherst, N. S. *Advt. 229.*  
Cochrane, Cassils & Co., Montreal, Que.
- 393—BOOTS—(Rubber), Sporting.**  
Canadian Rubber Co., Montreal, Que. *Advt. p. 197.*  
Rubber Shoe Co. (The), Toronto, Ont.  
Granby Rubber Co. Ltd., Granby, Que.
- 394—BOOTS & SHOES—Leather.**  
Ames, Holden Co., Montreal, Que. *Advt. page 228.*  
Amherst Boot & Shoe Co., Amherst, N. S. *Advt. 229.*  
Foster Boot & Shoe Co. (A. T.), Rock Island, Que.  
Bell, J. & T., Montreal, Que.  
Botterell, J. H. & Co., Quebec, Que.  
Cote, J. & M., St. Hyacinthe, Que.  
Cochrane, Cassils & Co., Montreal, Que.  
King, J. D. Co. Ltd., Toronto, Ont.  
Hamilton, W. B. Son & Co., Toronto, Ont.  
Jondro, Wm., Rock Island, Que.  
Harvey & Van Norman, Toronto, Ont.  
McPherson, J. & Co., Hamilton, Ont.  
McCready, James & Co., Montreal, Que.  
Stephens, J. & T. Co., Montreal, Que.  
Polly, W. H., Quebec, Que.  
Redding, W. H. Yarmouth, N. S.  
Slater, Geo. T. & Sons, Montreal, Que.  
Taylor, Robert & Co., Halifax, N. S.
- 395—BORAX—Calcined, Powdered, Refined.**  
Ewing, S. H. & A. S., Montreal, Que. *Advt. p. 238.*
- 396—BORDERING—Wire Garden.**  
Meadows, Geo. B., Toronto, Ont.
- 397—BORDERS—Grave, (Iron).**  
Toronto Fence & Iron Works, Toronto, Ont.  
Dennis Wire & Iron Works, London, Ont. *Advt. 207.*
- 398—BOTTLES—Water, (Rubber.)**  
Canadian Rubber Co. Ltd., Montreal, Que. *Advt. 197.*  
Alpha Rubber Co. Ltd., Montreal, Que.  
Rubber Co. Ltd. (The Toronto), Toronto, Ont.
- 399—BOTTLES—(Glass), Wine, Water, Toilet, Sewing Machine Oil, Prescription Bottles of every description a Specialty.**  
Lamont Glass Co., New Glasgow, N. S. *Advt. 231.*

- 400—BOTTLES—(Stoneware), Ink, Beer, Ginger Beer.**  
Brantford Stoneware Mfg Co. Ltd. (The), Brantford, Ont. *Advt. page 251.*  
Campbell, R., Hamilton, Ont. *Advt. page 230.*  
Glass Bro. & Co., London, Ont.
- 401—BOTTOMS—Copper.**  
American Copper Co., Toronto, Ont. *Advt. p. 157.*  
Davidson, (Thos.) Mfg Co., Montreal, Que. *Advt. 225.*  
Chadwick Bros., Hamilton, Ont. *Advt. page 206.*
- 402—BOUGIES.**  
Parke, Davis & Co., Walkerville, Ont.
- 403—BOWS—(Wood), Carriage.**  
Hore's, F. W. Sons, Hamilton, Ont.  
McVean, O. & W., Dresden, Ont.  
Canada Wheel Works, Merriton, Ont.
- 404—BOWLS—(Iron), Water, Cooking.**  
Smart, (Jas.) Mfg Co., Brockville, Ont. *Advt. p. 178.*  
Carrier, Laine & Co., Levis, Que. *Advt. page 150.*  
Burrow, Stewart & Milne, Hamilton, Ont.
- 405. BOWLS—Water Closet.**  
Dominion Sanitary Pottery Co., St. Johns, Que. *Advt. page 253.*
- 405 a—BOWLS—Water Closet, (The Perfect).**  
Campbell & Parvis, St. Johns, Que.
- 406—BOWLS—Wooden, Butter.**  
Chapman, C. F. & Co., Aylmer, Ont.
- 407—BOXES—Celluloid.**  
Barber & Ellis Co. Ltd., Toronto, Ont. *Advt. p. 192.*
- 408—BOXES—Cheese.**  
Biette & Co., Chesley, Ont. *Advt. page 240.*  
Macpherson & Schell, Chute'au Blondeau, Ont.  
Macpherson & Schell, Huntingdon, Que.  
Neibergall, J., Staples, P. O. Ont.  
Snider, Jesse, Hagersville, Ont.  
Acme Veneer Works, Orillia, Ont. *Advt. page 217.*  
Toronto Hopp & Veneer Co., Toronto, Ont. *Advt. page 234.*
- 409—BOXES—Cigar.**  
Ouelette, C. A., Tilbury, Ont.  
Firstbrook Bros., Toronto, Ont.  
Weiler Bros., Baden, Ont.  
Gerhardt Bros., Montreal, Que.  
Brantford Box Co. (The), Brantford, Ont.  
Beck, Adam, London, Ont.
- 410—BOXES—Cribbage.**  
Tees & Co., Montreal, Que. *Advt. page 225.*
- 411—BOXES—(Iron), Feed, Corner, Sponge.**  
Ives, H. R. & Co., Montreal, Que. *Advt. page 200.*  
Smart, (Jas.) Mfg Co., Brockville, Ont. *Advt. p. 178.*  
Tisdale Iron Stable Fitting Co. Ltd. (The), Toronto, Ont. *Advt. page 202.*
- 412—BOXES—(Iron), Twine.**  
Smart, (Jas.) Mfg Co., Brockville, Ont. *Advt. 178.*
- 413—BOXES—Lignumvitae Gang.**  
Bradley Bros., St. John, N. B.

**414—BOXES—(Packing), Wood, Tobacco, Shook, Dry Goods, Canned goods, Merchandise, Starch, Dovetailed, Candle, Bottle, Beer.**

Rathbun Co., Deseronto, Ont. *Advt. page 162.*  
Gravel (A.) Lumber Co., Etchemin, Que. *Advt. p. 215.*  
Dillingham, W. B., Quebec, Que.  
Ontario Box Co. Ltd., Hamilton, Ont.  
Georgian Bay (The), Box Co., Midland, Ont.  
Parker & Howe, Dixville, Que.  
Firstbrook Bros., Toronto, Ont.  
Ross, L. A., Cornwall, Ont.  
Edson, Fitch Co., Etchemin, Que.  
Watson's Box Factory, London, Ont.  
Chalifour, O., Quebec, Que.  
Flewwelling, (G. & G.) Mfg Co., Hampton, N. B.  
Esplin, G. & J., Montreal, Que.  
Pare, G. E., Quebec, Que.  
Bryan Mfg Co., Collingwood, Ont.  
Ruel, Edmond, Levis, Que.  
Barchard & Co., Toronto, Ont.

**415—BOXES—(Paper), Band, Candy, Cigarette, Collar, Clothing, Cuff, Druggists, Envelope, Pill, Shoe, Confectionery.**

Somerville, C. R., London, Ont. *Advt. page 235.*  
Miller Bros. & Co., Montreal, Que. *Advt. page 192.*  
Barber & Ellis Co. Ltd., Toronto, Ont. *Advt. p. 192.*  
Telfer Mfg Co., Toronto, Ont.  
Toronto Paper Box Co., Toronto, Ont.  
Brantford Box Co., Brantford, Ont.  
Brown, D. F. & Co., St. John, N. B.  
Elliott Paper Box Co., Toronto, Ont.  
Boehmer, A. & Co., Berlin, Ont.  
Canada Paper Box Factory, Montreal, Que.  
Dominion Corset Mfg Co., Quebec, Que.  
Ever Ready Dress Stay Co., Windsor, Ont.  
Picard, A. G., Quebec, Que.

**416—BOXES—(Section), Honey.**

Snowden, Wm., Peterborough, Ont.  
Phillips, T. & Co., Orillia, Ont. *Advt. page 259.*  
Russell, W. G., Millbrook, Ont.  
Goold, Shapely & Muir Co., Brantford, Ont. *Advt. page 191.*

**417—BOXES—(Iron), Letter.**

Peterboro Lock Mfg Co., Peterboro, Ont. *Advt. 219.*

**418—BOXES—(Conveyor), Seamless Steel.**

Goldie & McCulloch Co., Galt, Ont. *Advt. page 159.*  
Kerr & Morgan, Montreal, Que. *Advt. page 220.*  
Miller Bros. & Toms, Montreal, Que. *Advt. p. 197.*

**419—BOXES—Journal.**

Carrier, Laine & Co., Levis, Que. *Advt. page 150.*  
Wilson, J. C. & Co., Glenora, Ont.  
Lancaster Machine Works, Lancaster, Ont. *Advt. page 248.*  
Brown, G. & J. Mfg Co., Belleville, Ont. *Advt. 198.*

**420—BOXES—Leather, Plush.**

Barber & Ellis Co. Ltd., Toronto, Ont. *Advt. p. 192.*

**421—BOXES—(Shipping), Butter.**

Pierce, John S. & Co., London, Ont.  
Firstbrook Bros., Toronto, Ont.

**422—BOXES—(Cylinder), Butter, Lard.**

Belleville Box & Basket Co. Ltd., Belleville, Ont. *Advt. page 234.*

**423—BOXES—Street Car Conductors' Fare, Mite.**

Peterboro Lock Mfg Co., Peterboro, Ont. *Advt. 219.*  
Chadwick Bros., Hamilton, Ont. *Advt. page 206.*

**424—BOXES—(Hardware), Shelf.**

Firstbrook Bros., Toronto, Ont.  
Rathbun Co., Deseronto, Ont. *Advt. page 162.*  
Ontario Box Co. Ltd., Hamilton, Ont.  
Watson's Box Factory, London, Ont.  
Esplin, G. & J., Montreal, Que.  
Flewwelling, (G. & G.) Mfg Co., Hampton, N. B.

**425—BOXES—Resistance**

Toronto Electrical Works, Toronto, Ont.  
Royal Electric Co., Montreal, Que.  
Canadian General Electric Co. Ltd., Toronto, Ont.

**426—BOXES—Fire Alarm.**

Toronto Electrical Works, Toronto, Ont.  
Monnt Bros., Montreal, Que.

**427—BOXES—(Alarm), Watchman's.**

Ness, McLaren & Bate, Montreal, Que. *Advt. p. 240.*

**428—BOXES—Organ, Piano.**

Rathbun Co., Deseronto, Ont. *Advt. page 162.*  
Gilmour & Co., Trenton, Ont.  
Firstbrook Bros., Toronto, Ont.

**429—BOXES—Cart Axle.**

Ives, H. R. & Co., Montreal, Que. *Advt. page 200.*  
Smart, (Jas.) Mfg Co., Brockville, Ont. *Advt. 178.*

**430—BOXES—Car Axle.**

Crossen Car Mfg Co., Cobourg, Ont. *Advt. p. 160.*

**431—BOXES—Axle Grease.**

Ontario Basket Co. Ltd., Walkerville, Ont.  
Belleville Box & Basket Co. Ltd., Belleville, Ont. *Advt. page 234.*

**432—BOXES—Grindstone.**

Bertram, John & Sons, Dundas, Ont. *Advt. p. 161.*  
Smart, (Jas.) Mfg Co., Brockville, Ont. *Advt. 178.*

**433—BOXES—Hanger.**

Valleyfield Foundry & Machine Works, Valleyfield, Que. *Advt. page 191.*  
Macdonald & Co. Ltd., Halifax, N. S. *Advt. p. 256.*  
Brown, G. & J. Mfg Co., Belleville, Ont. *Advt. 198.*

**434—BOXES—Hanger.**

Goldie & McCulloch Co., Galt, Ont. *Advt. page 159.*  
Bertram, John & Sons, Dundas, Ont. *Advt. page 161.*

**435—BOXES—Veneer.**

Belleville Box & Basket Co. Ltd., Belleville, Ont. *Advt. page 234.*  
St. Catharines Box & Basket Co. Ltd., St. Catharines, Ont. *Advt. page 203.*

**436—BOXES—Axe, Tool.**

Rathbun Co., Deseronto, Ont., *Advt. page 162.*  
Flewwelling, (G. & G.) Mfg Co., Hampton, Ont.

**437—BOXES—Safe Deposit.**

Goldie & McCulloch Co., Galt, Ont. *Advt. page 159.*

**438—BOXES—Locomotive Driving.**

Canadian Locomotive & Engine Co. Ltd., Kingston, Ont. *Advt. page 175.*

**439—BOXES—Confessional.**

Paquet &amp; Godbout, St. Hyacinthe, Que.

**440—BOXES—(Hub), Axle.**Gurney, Tilden Co. Ltd., Hamilton, Ont. *Advt. p. 151.*Carrier, Laine & Co., Levis, Que. *Advt. page 150.*

Raymond, Chas., Guelph, Ont.

Smart, (Jas.) Mfg Co., Brockville, Ont. *Advt. p. 178.***441—BOXES—(Leather), Hat, Cuff, Dice.**

Clack, H. E. &amp; Co., Toronto, Ont.

Marlett &amp; Armstrong, Oakville, Ont.

**442—BOXES—Pill, (Round Wood).**Hope, John, Lachute, Que. *Advt. page 188.*Thompson & Co., Sherbrooke, Que. *Advt. p. 228.*

Edson, Fitch Co., Etchemin, Que.

**443—BOXES—Plant, (Berry).**St. Catharines Box & Basket Co. Ltd., St. Catharines, Ont. *Advt. page 203.*Oakville Basket Co., Oakville, Ont. *Advt. page 234.*Belleville Box & Basket Co. Ltd., Belleville, Ont. *Advt. page 234.***444—BOXES—Fancy, Plush.**Barber & Ellis Co. Ltd., Toronto, Ont. *Advt. p. 192.***445—BOXES—(Tin), Blacking, Ointment, Tobacco, Twine, Sardine, Lunch, Salt, Pepper, Document, Cash, Bread, Spice, Cake.**

Macdonald &amp; Co. Ltd., Toronto, Ont.

Davidson Mfg Co., Montreal, Que. *Advt. page 225.***446—BOXES—(Tin), Match.**Davidson Mfg Co., Montreal, Que. *Advt. page 225.***447—BRACES—Bit.**Smart, (Jas.) Mfg Co., Brockville, Ont. *Advt. p. 178.*Parmenter & Bulloch, Gananoque, Ont. *Advt. p. 199.***448—BRACES—(Steel Spring), Larigan, Mocasin, Shoe.**Parmenter & Bulloch, Gananoque, Ont. *Advt. p. 199.***449—BRACES—Rail.**Canada Spring & Switch Mfg Co. Ltd., Montreal, Que. *Advt. page 217.***450—BRACES—(Shoulder), Elastic, Non-Elastic, Web=Surgical.**Stouffer, (J. R.) Co. Ltd., Berlin, Ont. *Advt. p. 185.*Hall, James & Co., Brockville, Ont. *Advt. page 227.*

Globe Suspender Co., Rock Island, Que.

Dominion Suspender Co., Niagara Falls, Ont.

Wilmot Corset Co., South Farmington, N. S.

Vroom, C. N., St. Stephen, N. B. *Advt. page 257.***451—BRACES—Lace Back, Excelsior Grip Back.**Stouffer, (J. R.) Co. Ltd., Berlin, Ont. *Advt. p. 185.***452—BRACES—(Iron), Sleigh Knee.**Swansea Forging Co., Swansea, Ont. *Advt. p. 156.***453—BRACES—Top.**Gillies, Geo. Co. Ltd., Gananoque, Ont. *Advt. p. 156.*Swansea Forging Co., Swansea, Ont. *Advt. p. 156.***454—BRACKETS—Rafter.**Laing, Ritchie & Co., Essex, Ont. *Advt. page 209.***455—BRACKETS—Wall (Machinery).**

Robb Engineering Co. Ltd., Amherst, N. S.

*See inside front cover.*

Wilson, J. C. &amp; Co., Glenora, Ont.

**456—BRACKETS—Bird Cage.**

Wright, E. T. &amp; Co., Hamilton, Ont.

**457—BRACKETS—Cistern.**Young & Bro. Co. Ltd., Hamilton, Ont. *Advt. p. 257.***458—BRACKETS—(Brass), Curtain Pole, Plumbers', Gas, Window Display, Lamp, Dental.**Mitchell, Robert & Co. Montreal, Que. *Advt. p. 213.*Garth & Co., Montreal, Que. *Advt. page 154.*Morrison, (Jas.) Brass Mfg Co., Toronto, Ont. *Advt. page 157.*Hamilton Brass Mfg Co., Hamilton, Ont. *Advt. p. 168.*American Copper Co., Toronto, Ont. *Advt. page 157.*Essex Brass & Iron Co., London, Ont. *Advt. p. 257.*McAvity, T. & Son, St. John, N. B. *Advt. page 153.*Peterboro Lock Mfg Co., Peterboro, Ont. *Advt. 219.*Coulter & Campbell, Toronto, Ont. *Advt. page 201.*Macdonald & Co., Ltd., Halifax, N. S. *Advt. p. 256.***459—BRACKETS—(Iron), Balcony, Flower Pot, Shelf, Lamp, Electric Light, Street Lamp, Window, Wall, Hand Rail.**Carrier, Laine & Co., Levis, Que. *Advt. page 150.*Dennis Wire & Iron Works, London, Ont. *Advt. p. 207.*Garth & Co., Montreal, Que. *Advt. page 154.*Fraser Bros., New Glasgow, N. S. *Advt. page 252.*Smart, (Jas.), Mfg Co., Brockville, Ont. *Advt. p. 178.*Ives, H. R. & Co., Montreal, Que. *Advt. page 150.*Woodyatt, A. R. & Co., Guelph, Ont. *Advt. p. 207.***460—BRACKETS—Metal Pew Rack.**Garth & Co., Montreal, Que. *Advt. page 154.*Ives, H. R. & Co., Montreal, Que. *Advt. page 200.***461—BRACKETS—Piano.**Woodyatt, A. R. & Co., Guelph, Ont. *Advt. p. 207.*

Foisly, Thos. F. G., Montreal, Que.

**462 BRACKETS—Pump.**McDougall, R. & Co., Galt, Ont. *Advt. page 199.*

Wortman &amp; Ward Mfg Co., London, Ont.

**463—BRACKETS—Saddle, Lantern, Harness, Carriage Pole, Bridle, Blanket.**Woodyatt, A. R. & Co., Guelph, Ont. *Advt. page 207.*Tisdale Iron Stable Fitting Co. Ltd., Toronto, Ont. *Advt. page 202.*Garth & Co., Montreal, Que. *Advt. page 154.*Smart, (Jas.) Mfg Co., Brockville, Ont. *Advt. p. 178.*Peterboro Lock Mfg Co., Peterboro, Ont. *Advt. 219.*Carrier, Laine & Co., Levis, Que. *Advt. page 150.*Ives, H. R. & Co., Montreal, Que. *Advt. page 200.***464—BRACKETS—Wooden.**Rhodes, Curry & Co., Amherst, N. S. *Advt. page 158.*Edwards, W. C. & Co., Ottawa, Ont. *Advt. p. 219.*

New York Mantle Decorating Co. Montreal, Que.

Gignac, O. &amp; Sons, Quebec, Que.

Rathbun Co., Deseronto, Ont. *Advt. page 162.***465—BRACELETS—Gold, Silver, Bangle, Band.**

Ellis, P. W. &amp; Co., Toronto, Ont.

- Dominion Rolled Plate Co., Montreal, Que. *Advt.* 236.  
Bramley, Wm., Montreal, Que. *Advt.* page 236.
- 466—BRADS—Brass, Copper, Steel.**  
Parmenter & Bullock, Gananoque, Ont. *Advt.* p. 199.
- 467—BRADS—Cut.**  
Montreal Rolling Mills Co., Montreal. *Advt.* p. 174.  
Portland Rolling Mills, St. John, N. B. *Advt.* p. 195.  
Cowan & Britton, Gananoque, Ont.  
Ontario Tack Co., Hamilton, Ont. *Advt.* page 180.
- 468—BRADS—Wire.**  
Dominion Wire Mfg Co., Montreal, Que. *Advt.* p. 176.  
Ontario Lead & Barb Wire Co. Ltd., Toronto, Ont.  
*Advt.* page 177.  
Safety Barb Wire Co., Toronto, Ont. *Advt.* p. 180.  
Western Wire & Nail Co. London, Ont. *Advt.* p. 177.  
Parmenter & Bullock, Gananoque, Ont. *Advt.* p. 199.  
Gordon, J. J., St. John, N. B. *Advt.* page 213.
- 469—BRAIDS—Worsted, Tubular, Tailors.**  
Belding, Paul & Co. Montreal, Que. *Advt.* page 183.  
Corticelli Silk Co., St. Johns, Que. *Advt.* page 182.  
Cascade Narrow Fabric Co., Coaticook, Que.  
*Advt.* page 188.
- 470—BRAIDS—Lama, Piping, Jewelers', Silk, Mohair.**  
Belding, Paul & Co., Montreal, Que. *Advt.* page 183.  
Corticelli Silk Co., St. Johns, Que. *Advt.* page 182.
- 471—BRAKES—Cornice.**  
Brown, Boggs & Co., Hamilton, Ont. *Advt.* p. 193.  
Erwin, R. W., Shelburne, Ont.
- 472—BRAKES—Bakers' Dough.**  
Pendrith, G. T., Toronto, Ont.
- 473—BRAKES—Heavy Screw.**  
Brown, Boggs & Co., Hamilton, Ont. *Advt.* p. 193.
- 474—BRAKES—Locomotive.**  
Canadian Locomotive & Engine Co. Ltd., Kingston, Ont. *Advt.* page 175.
- 475—BRANCHES—Tee & Y. Clay Pipe.**  
Standard Drain Pipe Co., St. John, Que. *Advt.* p. 251.  
Hamilton & Toronto Sewer Pipe Co., Hamilton, Ont.
- 476—BRANCHES—(Plumber), Tee & Y. Pipe (Iron), Bent.**  
Garth & Co., Montreal, Que. *Advt.* page 154.  
Young & Bro. Co., Hamilton, Ont. *Advt.* page 257.
- 477—BRANDS—Burning.**  
Patterson & Heward, Toronto, Ont. *Advt.* page 201.  
Fell, I. C. & Co., Toronto, Ont.  
Macdonald & Co. Ltd., Halifax, N. S. *Advt.* p. 256.
- 478—BRASS—Ingot.**  
Frankel Bros., Toronto, Ont. *Advt.* page 255.
- 479—BRASS—Aluminum, Roll, Sheet, Stick, Strip.**  
Garth & Co., Montreal, Que. *Advt.* page 154.  
McAvity, T. & Sons, St. John, N. B. *Advt.* p. 153.  
Hamilton Brass Mfg Co., Hamilton, Ont. *Advt.* p. 168.  
Morrison, (Jas.) Brass Mfg Co., Toronto. *Advt.* p. 157.  
Parker, J. O., & Co., Toronto, Ont. *Advt.* page 253.

**480—BRASS WORK—Architectural, Office, Church, Plumbers'.**

- Chadwick Bros., Hamilton, Ont. *Advt.* page 206.  
Macdonald & Co. Ltd., Halifax, N. S. *Advt.* p. 256.  
Garth & Co., Montreal, Que. *Advt.* page 154.  
McAvity, T. & Sons, St. John, N. B. *Advt.* page 153.  
Hamilton Brass Mfg Co., Hamilton, Ont. *Advt.* p. 168.  
American Copper Co., Toronto, Ont. *Advt.* page 157.  
Essex Brass & Iron Co., London, Ont. *Advt.* p. 257.  
Booth Copper Co., Toronto, Ont. *Advt.* page 155.  
Coulter & Campbell, Toronto, Ont. *Advt.* page 201.  
Mitchell, Robert & Co., Montreal, Que. *Advt.* p. 213.

**481—BRASS WORK—Spun Metal.**

- Chadwick Bros., Hamilton, Ont. *Advt.* page 206.  
American Copper Co., Toronto, Ont. *Advt.* page 157.  
Parker, J. O. & Co., Toronto, Ont. *Advt.* page 253.

**482—BRASSES—Memorial.**

- Patterson & Heward, Toronto, Ont. *Advt.* page 201.  
Pritchard & Andrews, Ottawa, Ont. *Advt.* page 250.  
Rolph, Smith & Co., Toronto, Ont.

**483—BRASSES—Journal, Machinery, Rolling Mill.**

- Carrier, Laine & Co., Levis, Que. *Advt.* page 150.  
Garth & Co., Montreal, Que. *Advt.* page 154.  
Macdonald & Co. Ltd., Halifax N. S. *Advt.* p. 256.  
Morrison, (Jas.) Brass Mfg Co., Toronto. *Advt.* p. 157.  
McAvity, T. & Sons, St. John, N. B. *Advt.* p. 153.  
Essex Brass & Iron Co., London, Ont. *Advt.* p. 257.  
Hamilton Brass Mfg Co., Hamilton, Ont. *Advt.* p. 168.  
Mitchell, Robert & Co., Montreal, Que. *Advt.* p. 213.  
Parker, J. O. & Co. Toronto, Ont. *Advt.* p. 253.  
Skinner & Co., Gananoque, Ont. *Advt.* page 255.

**484—BREAD—Ship.**

- Halifax Confectionery & Baking Co., Halifax, N. S.  
Moir, Son & Co., Halifax, N. S.  
Rankine, T. & Sons, St. John, N. B.

**485—BREAKERS—Flax.**

- Moody, Matthew & Sons, Terrebonne, Que.  
*Advt.* page 209.

**486—BREASTS—Tea Kettle (Copper).**

- Booth Copper Co., Toronto, Ont. *Advt.* page 155.  
Chadwick Bros., Hamilton, Ont. *Advt.* page 206.  
Parker, J. O. & Co., Toronto, Ont. *Advt.* page 253.  
American Copper Co., Toronto, Ont. *Advt.* page 157.  
Coulter & Campbell, Toronto, Ont. *Advt.* page 201.

**487—BRICK—Philadelphia Red, Milwaukee Light, Milwaukee Red.**

- Howe, William, Ottawa, Ont. *Advt.* page 201.

**488—BRICK—Pressed (Metal).**

- Metallick Roofing Co. Ltd. (The), Toronto, Ont.  
*See front fly leaf.*

**489—BRICK—Hollow Fireproof, Pressed Building, Porous, Solid.**

- Rathbun Co., Deseronto, Ont. *Advt.* page 162.

**490—BRICK—Furnace.**

- Garth & Co., Montreal, Que. *Advt.* page 154.  
Glass Bros. & Co., London, Ont.

**491—BRICK—Fire.**

- Campbell, R., Hamilton, Ont. *Advt.* page 230.  
Hart Bros. & Lazier, Belleville, Ont. *Advt.* p. 230.

**492—BRICK—Ventilator.**

Gurney, Tilden Co. Ltd., Hamilton, Ont. *Adv. p. 151.*  
Young & Bro. Co. Ltd., Hamilton, Ont. *Adv. p. 257.*  
Ives, H. R. & Co., Montreal, Que. *Adv. page 200.*  
Smart, (Jas.) Mfg Co., Brockville, Ont. *Adv. p. 178.*

**493—BRICK—(Pressed), Ornamental, Terra Cotta.**

Montreal Terra Cotta & Lumber Co., Montreal, Que. *Adv. page 214.*  
Rathbun Co. (The), Deseronto, Ont. *Adv. page 162.*  
Beamsville Pressed Brick Co., Beamsville, Ont. *Adv. page 215.*  
Taylor Bros., Toronto, Ont.

**494—BRIDGES—Wire Foot.**

Page Wire Fence Co., Walkerville, Ont. *Adv. p. 180.*

**495—BRIDGES—(Iron & Steel), Highway, Roadway.**

Dominion Bridge Co., Montreal, Que. *Adv. p. 195.*  
Central Bridge & Engineering Co. Ltd., Peterborough, Ont. *Adv. page 214.*  
Brown, (G. & J.) Mfg Co., Belleville, Ont. *Adv. page 198.*  
Stewart, John, New Glasgow, N. S. *Adv. page 222.*  
Stratford Bridge & Iron Works Co., Stratford, Ont. *Adv. page 252.*

**496—BRIDGES—"Dominion."**

Dominion Bridge Co., Montreal, Que. *Adv. p. 195.*

**497—BRIDGES—Canal, Cantilever, Draw, Foot, Lift, Railway, Suspension, Swing.**

Dominion Bridge Co., Montreal, Que. *Adv. p. 195.*  
Central Bridge & Engineering Co. Ltd., Peterborough, Ont. *Adv. page 214.*  
Brown, (& J.) Mfg Co., Belleville, Ont. *Adv. page 198.*  
Stewart, John, New Glasgow, N. S. *Adv. page 222.*

**498—BRIDLES—Riding.**

Borbridge, S. & H., Ottawa, Ont.  
Verreault, Henri, Levis, Que.

**499—BRISTOLS—Duplex Translucent (Paper Board) Tinted.**

Ritchie & Ramsay, Toronto, Ont. *Adv. page 189.*

**500—BROILERS—Meat (Wire).**

Meadows, Geo. B., Toronto, Ont.

**501—BROILERS—Meat (Iron).**

Dennis Iron & Wire Works, London, Ont. *Adv. 207.*  
Gurney, Tilden Co., Hamilton, Ont. *Adv. page 151.*

**502—BROMSLIN.**

Parke, Davis & Co., Walkerville, Ont.

**503—BROMIDE OF COPPER—(Solid) Sodium, Zinc, Ammonium, Calcium, Cadonium, Potassium.**

Lyman Bros. & Co. Ltd., Toronto, Ont.

**504—BRONZE—Phosphor.**

Morrison, Jas. Brass Mfg Co., Toronto, Ont. *Adv. page 157.*  
Macdonald & Co. Ltd., Halifax, N. S. *Adv. p. 256.*  
Mitchell, Robert & Co., Montreal, Que. *Adv. p. 213.*

**505—BRONZE—Liquid.**

Canada Paint Co., Montreal, Que. *Adv. page 221.*  
Howe William, Ottawa, Ont. *Adv. page 201.*

**506—BRONZE—Church.**

Lanctot, C. B., Montreal, Que.

**507—BROOMS—Stable, Street, Cane, Wire.**

Bryan, Thomas, London, Ont. *Adv. page 212.*  
Meakins & Sons., Montreal, Que. *Adv. page 237.*  
Meakins & Co., Hamilton, Ont.  
Boeckh, Chas. & Sons, Toronto, Ont.

**508—BROOMS—Corn, Whisk.**

Nelson, H. A. & Sons, Montreal, Que.  
Patent Brush Co. Ltd., Sandwich, Ont.  
Gelinias, C. P. & Bros., Three Rivers, Que.  
Telfer Bros., Collingwood, Ont.  
Reed & Co., Fredericton, N. B.  
Quebec Steam Brush & Broom Factory, Quebec, Que.  
Boeckh, Chas. & Sons, Toronto, Ont.  
Reardon, W., Ottawa, Ont.

**509—BRUSHES—Stable, Cheese Factory.**

Bryan, Thomas, London, Ont. *Adv. page 212.*

**510—BRUSHES—Skimming, Flesh, Chamois, Pocket Hat.**

Bryan, Thomas, London, Ont. *Adv. page 212.*  
Meakins & Co., Montreal, Que. *Adv. page 237.*  
Boeckh, Chas. & Sons, Toronto, Ont.

**511—BRUSHES—Dynamo Carbon, Motor.**

Ness, McLaren & Bate, Montreal, Que. *Adv. p. 240.*  
Kay Electric Mfg Co., Hamilton, Ont. *Adv. p. 233.*  
Canadian General Electric Co. Ltd., Toronto, Ont.  
Royal Electric Co., Montreal, Que.

**512—BRUSHES—Tanners', Stippling, Velvet, Varnish, Stencil, Window, Wood Filers', Moulders'.**

Bryan, Thomas, London, Ont. *Adv. page 212.*  
Boeckh, Chas. & Sons, Toronto, Ont.  
Meakins & Co., Montreal, Que. *Adv. page 237.*

**513—BRUSHES—(Woven Wire), Dynamo.**

Forrister, Thos. Montreal, Que. *See front fly leaf.*

**514—BRUSHES—Printers' Lye, Household & Cleansing, Toilet, Glass Cleaning, White-wash, Scrub, Shoe, Kalsomine, Horse, Wall, Stove.**

Bryan, Thomas, London, Ont. *Adv. page 212.*  
Boeckh, Chas. & Sons, Toronto, Ont.  
Meakins & Co., Montreal, Que. *Adv. page 237.*  
Quebec Steam Brush & Broom Factory, Quebec, Que.  
Patent Brush Co. Ltd., Sandwich, Ont.  
Ulley, J. J. & Son, Montreal, Que.

**515—BRUSHES—Billiard Table, Blind, Bottle, Clothes, Painters', Waxing, Glue, Hair, Hat, Lamp Chimney, Marking, Paint, Paper Hangers', Tar, Shaving, Bath.**

Bryan, Thomas, London, Ont. *Adv. page 212.*  
Meakins & Co., Montreal, Que. *Adv. page 237.*  
Boeckh, Chas. & Son, Toronto, Ont.  
Meakins & Sons, Hamilton, Ont.

**516—BUCKLER—Belt.**

Whitman & Barnes Mfg Co., St. Catharines, Ont.

**517—BUCKLES—Trace, Rain, Pole Strap, Girth, Cross Strap, Collar, Bridle, Harness.**

Coleman, V. A., Port Hope, Ont.  
Burrow, Stewart & Milne, Hamilton, Ont.  
Martin Mfg Co., Whitby, Ont.  
Kyle, P., Merrickville, Ont.

**518—BUCKLES—Suspender.**

McKinnon, Dash & Hardware Co., St. Catharines, Ont. *Advt. page 202.*  
Dunn, Patrick, Cote St. Paul, Que.

**519—BUCKLES—Truss.**

Authors & Cox, Toronto, Ont.

**520—BUCKLES—(Turn), Bridge, Steel, Iron.**

Swansea Forging Co., Swansea, Ont. *Advt. page 156.*  
Canada Spring & Switch Co., Montreal, *Advt. p. 217.*

**521—BUCKLES—Shoe, Overshoe, Arctic.**

Parmenter & Bulloch, Gananoque, Ont. *Advt. p. 199.*

**522—BUCKRAMS.**

Dick, Ridout & Co., Toronto, Ont.

**523—BULLION—Gold & Silver Embroidered.**

Coddington, W. H., Hamilton, Ont. *Advt. p. 183.*

**524—BUCKS—Folding Saw.**

Otterville Mfg Co. Ltd., Otterville, Ont. *Advt. p. 259.*

**525—BUFFERS—(Shoe Machinery).**

Kieffer Bros., Montreal, Que.

**526—BUGLES.**

Whaley, Royce & Co., Toronto, Ont. *Advt. page 189.*

**527—BUILDINGS—Iron.**

Dominion Bridge Co., Montreal, Que. *Advt. p. 195.*

**528—BUILDINGS—Steel (Sheet Metal).**

Metallic Roofing Co. of Canada Ltd. (The), Toronto, Ont. *See front fly leaf.*

**529—BULBS—Rubber.**

Alpha Rubber Co. Ltd., Montreal, Que.

**530—BUMPERs—Rubber.**

Canadian Rubber Co., Montreal, Que. *Advt. p. 197.*

**531—BUNGS—Wood, Cork.**

Doyle, J. E. & Co., Montreal, Que. *Advt. page 235.*  
Canada Cork Cutting Co., Montreal, Que. *Advt. p. 223.*  
Cork Co. of Canada, Toronto, Ont. *Advt. page 187.*

**532—BUOYS—Life.**

Soper, R., Hamilton, Ont. *Advt. page 229.*  
Farhan Bros., Halifax, N. S.

**533—BURNERS—Coal Oil, Gasoline.**

Brown, Boggs & Co., Hamilton, Ont. *Advt. p. 193.*

**534—BURNERS—Refuse, (Saw Mill).**

Jenckes Machine Co., Sherbrooke, Que. *Advt. p. 165.*  
Carrier, Laine & Co., Levis, Que. *Advt. page 150.*

**635—BURNERS—Paint.**

McAvity, T. & Sons, St. John, N. B. *Advt. p. 153.*

**536—BURNERS—Lantern, Lamp.**

Dominion Tubular Lamp Co., Montreal, Que.

**537—BURNERS—Gas.**

Morrison, (Jas.) Mfg Co., Toronto, Ont. *Advt. p. 157.*  
McAvity, T. & Sons, St. John, N. B. *Advt. page 153.*  
Mitchell, Robert & Co., Montreal, Que. *Advt. p. 213.*  
Garth & Co., Montreal, Que. *Advt. page 154.*

**538—BURNISHERS—Heel (Boot & Shoe).**

Consigny, N., Quebec, Que.  
Pettner, B. J., Montreal, Que.

**539—BURRS—Brass, Copper, Steel.**

Parmenter & Bulloch, Gananoque, Ont. *Advt. p. 199.*  
Canada Screw Co., Hamilton, Ont. *Advt. page 226.*

**540—BURRS—Iron.**

Abbott & Co., Montreal, Que. *Advt. page 196.*  
Canada Screw Co., Hamilton, Ont. *Advt. page 226.*  
Parmenter & Bulloch, Gananoque, Ont. *Advt. p. 199.*

**541—BURRS—Steel Shafting.**

Brush, Geo., Montreal, Que.

**542—BUSHES—Bung.**

Otterville Mfg Co. Ltd., Otterville, Ont. *Advt. p. 259.*  
Kyle, P., Merrickville, Ont.

**543—BUSHES—Car.**

Rhodes, Curry & Co., Amherst, N. S. *Advt. p. 158.*

**544—BUSHINGS—Patent Roller.**

Bradley Bros., St. John, N. B.

**545—BUTTERCUPS—Candy.**

McCormick Mfg Co. Ltd., London, Ont.

**546—BUTTERISES—Farriers'.**

Butterfield & Co., Rock Island, Que.

**547—BUTTONS—Composition, Pearl.**

Shantz & Son Co. (Jacob Y.), Berlin, Ont. *Advt. 184.*

**548—BUTTONS—Cloth Covered, Rim.**

Stouffer, (J. R.) Co. Ltd., Berlin, Ont. *Advt. p. 185.*

**549—BUTTONS—Wood.**

Hope, John, Lachute, Que. *Advt. page 188.*  
Thompson & Co., Sherbrooke, Que. *Advt. page 228.*  
Wesley, F. J. & Co., Toronto Junction, Ont.

**550—BUTTONS—Pearlette, Horn, Vegetable Ivory.**

Shantz & Son Co. (Jacob Y.), Berlin, Ont. *Advt. 184.*  
Baril, F., Warwick, Que.  
Roschman, Richard, Waterloo, Ont.

**551—BUTTONS—Push.**

Garth & Co., Montreal, Que. *Advt. page 154.*  
Ness, McLaren & Bate, Montreal, Que. *Advt. p. 240.*  
Toronto Electrical Works, Toronto, Ont.  
Starr, John Son & Co., Halifax, N. S.

**552—BUTTONS—Furniture Tufting.**

Montreal Rolling Mills Co. Ltd., Montreal, Que. *Advt. page 174.*  
Ontario Tack Co., Hamilton, Ont. *Advt. page 180.*

**553—BUTTONS—Commode, Hardware, Door.**

Ives, H. R. & Co., Montreal, Que. *Advt. page 200.*  
Smart, (Jas.) Mfg Co., Brockville, Ont. *Advt. p. 178.*  
Woodyatt, A. R. & Co., Guelph, Ont. *Advt. p. 207.*  
Peterboro Lock Mfg Co., Peterboro, Ont. *Advt. p. 219.*

**554—BUTTONS—Collar, Cuff, & Cuff Link  
Silver, Ladies' Cuff & Collar, Gold Plated.**

Dominion Rolled Plate Co., Montreal, Que.  
*Advt. page 236.*

**555—BUTTS—Whip.**

Parker & Howe, Dixville, Que.

**556—BUTTS—Loose Pin, Loose Joint, Cast.**

Smart, (Jas.) Mfg Co., Brockville, Ont. *Advt. p. 178.*  
Peterboro Lock Mfg Co., Peterboro, Ont. *Advt. p. 219.*

**557—BUTTS—Iron, Special, Steel, Wrought,  
Shutter, Door.**

Cowan & Britton, Gananoque, Ont.  
Smart, (Jas.) Mfg Co., Brockville, Ont. *Advt. p. 178.*

**558—BUTTS—Bronze, Nickel Plated, Double  
Acting Spring, Brass.**

Garth & Co., Montreal, Que. *Advt. page 154.*  
Peterboro Lock Mfg Co., Peterboro, Ont. *Advt. p. 219.*

**559—BUOYS—(Iron & Steel), Can, Cage, Nun.**

Carrier, Laine & Co., Levis, Que. *Advt. page 150.*  
Patterson, John, Halifax, N. S. *Advt. page 194.*

**560—BUCKETS—Clam Shell, (Dredge).**

Beatty, M. & Sons, Welland, Ont. *Advt. page 173.*

**561—BUCKETS—Stable, Sap (Wood).**

Cane, (The Wm.) & Sons Mfg Co. Ltd., Newmarket,  
Ont. *Advt. page 218.*

**562—BUCKETS—(Rubber), Pump, Fire.**

Canadian Rubber Co., Montreal, Que. *Advt. p. 197.*  
Toronto Rubber Co. Ltd. (The), Toronto, Ont.  
Gutta Percha & Rubber Mfg Co. Ltd., Toronto,  
Ont. *See back cover.*

**563—BUCKETS—Leather.**

Robin, Sadler & Haworth, Montreal, Que.  
*Advt. page 226.*  
McLaren, (The J. C.) Belting Co., Montreal, Que.

**564—BUCKETS—Galvanized Iron Fire, Factory.**

Piper, Noah L. & Son, Toronto, Ont.  
Davidson, (The Thos.) Mfg Co. Ltd., Montreal, Que.  
*Advt. page 225.*

**565—BUCKETS—Dredge, Iron, Steel, Ore,  
Coal, Hoisting.**

Beatty, M. & Sons, Welland, Ont. *Advt. page 173.*  
Jenckes Machine Co., Sherbrooke, Que. *Advt. p. 165.*  
Carrier, Laine & Co., Levis, Que. *Advt. page 150.*  
Matheson, I. & Co., New Glasgow, N. S. *Advt. p. 200.*

**566—CABINETS—Bamboo, Oak.**

Thompson, Alex. & Co., Hamilton, Ont.  
Cobban Mfg Co. Ltd., Toronto, Ont.  
Gendron Mfg Co., Toronto, Ont. *Advt. page 187.*

**567—CABINETS—Silk, Spool.**

Corticelli Silk Co., St. John, N. B. *Advt. page 182.*

**568—CABINETS—Sewing Machine.**

Raymond, Charles, Guelph, Ont.

**569—CABINETS—Roll Top, Portfolio.**

Rathbun Co. (The), Deseronto, Ont. *Advt. page 162.*  
Tess & Co., Montreal, Que. *Advt. page 225.*

**570—CABINETS—Parlor.**

Tees & Co., Montreal, Que. *Advt. page 225.*  
Gibbard Furniture Co. Ltd., Napanee, Ont.

**571—CABINETS—Music.**

Goderich Organ Co., Goderich, Ont.  
Otterville Mfg Co. Ltd., Otterville, Ont. *Advt. p. 259.*  
Tees & Co., Montreal, Que. *Advt. page 225.*

**572—CABINETS—Ladies' Writing, Physi-  
cians'.**

Tees & Co., Montreal, Que. *Advt. page 225.*  
Canadian Office & School Furniture Co. Ltd. (The),  
Preston, Ont. *Advt. page 210.*

**573—CABINETS—Instrument.**

Clark Dental Mfg Co. (The), Toronto, Ont.  
Harvard Chair Co. Ltd. (The), Toronto, Ont.

**574—CABINETS—Galvanized Iron Oil.**

Davidson Mfg Co. (Thos.), Montreal, Que. *Advt. 225*

**575—CABINETS—Cutlery, Silverware.**

Hemming Bros. Co. Ltd. (The), Toronto, Ont.

**576—CABINETS—Book, Wall, Stationery.**

Rathbun Co. (The), Deseronto, Ont. *Advt. p. 162.*

**577—CABINETS—Bill & Letter Filing, Ra-  
diator.**

Canadian Office & School Furniture Co. Ltd. (The),  
Preston, Ont. *Advt. page 210.*  
Office Specialty Mfg Co., Toronto, Ont.

**578—CABINETS—Coin.**

Tees & Co., Montreal, Que. *Advt. page 225.*

**579—CABLE—Truss Wire.**

Ontario Lead & Barb Wire Co. Ltd., Toronto, Ont.  
*Advt. page 177.*

**580—CABLES—(Electric), Aerial, Telephone,  
Telegraph, Electric Light, Insulated.**

Canadian General Electric Co. Ltd., Toronto, Ont.  
Bell Telephone Co., Montreal, Que.  
Phillips Electrical Works, Montreal, Que.  
Royal Electric Co. Montreal, Que.

**581—CABLES—Bridge, Oil Wheel, Steel, Steel  
Railway, Terra Cotta Strand.**

Dominion Wire Rope Co., Montreal, Que. *Advt. 171.*

**582—CABS—Hotel.**

Campbell, John, London, Ont.  
Guy, Matthew, Toronto, Ont.

**583—CADDIES—(Tin), Tea.**

Davidson Mfg Co. (Thos.), Montreal, Que. *Advt. 225.*  
Macdonald Mfg Co. (The), Toronto, Ont.

**584—CADDIES—(Paper), Tea.**

Brown, D. F. & Co., St. John, N. B.  
Toronto Paper Box Co. Toronto, Ont.  
Kilgour Bros., Toronto, Ont.

**585—CADMIUM—Bromide, Chloride, Iodide.**

Lyman Bros. & Co., Toronto, Ont.

**586—CAFFEINE—(Citrate of).**

Lyman Bros. & Co. Ltd., Toronto, Ont.



- 587—CAGES—(Shipping), Queen Bee.**  
Goold, Shapely & Muir Co., Brantford, Ont.  
*Advt. page 191.*  
Russell, W. G., Millbrook, Ont.
- 588—CAGES—Safety Mine, Mining.**  
Keer & Morgan, Montreal, Que. *Advt. page 220.*  
Jenckes Machine Co., Sherbrooke, Que. *Advt. p. 165.*  
Miller Bros. & Toms, Montreal, Que. *Advt. p. 197.*  
Matheson, I. & Co. New Glasgow, N. S. *Advt. p. 200.*
- 589—CAGES—(Wire), Bird, Parrot, Squirrel.**  
Meadows, Geo. B., Toronto, Ont.  
Davidson Mfg Co. (Thos.), Montreal, Que. *Advt. 225.*  
Dennis Wire & Iron Works, London, Ont. *Advt. 207.*
- 590—CAGES—(Tin), Bird, Squirrel, Parrot.**  
Kemp Mfg Co. (The), Toronto, Ont.  
Davidson Mfg Co. (Thos.), Montreal, Que. *Advt. 225.*
- 591—CAKE—Oil.**  
Body & Noakes, Winnipeg, Man.  
Hardy & Dubord, Beauport, Que.
- 592—CALCIUM—Bromide, Chloride.**  
Lyman Bros. & Co. Ltd., Toronto, Ont.
- 593—CALENDARS—Date, Advertising.**  
*See No. 639.*
- 594—CALKS—Horseshoe.**  
Montreal Rolling Mills Co., Montreal. *Advt. p. 174.*
- 595—CAMERAS—Surveyors'.**  
Foster, James, Toronto, Ont.
- 596—CANDLES—Paraffine.**  
Imperial Oil Co., Petrolia, Ont. *Advt. page 230.*  
Rogers, Samuel & Co., Toronto, Ont. *Advt. p. 240.*
- 597—CANDLES—Tallow.**  
Mott, John P. & Co., Halifax, N. S.  
Strachan, W. & Co., Montreal, Que.  
Maheux, N., Quebec, Que.  
Taylor, John & Co., Toronto, Ont.
- 598—CANDLES—(Wax), Church, Decorative.**  
Imperial Oil Co., Petrolia, Ont. *Advt. page 230.*  
Molleur, J. E., St. Johns, Que.
- 599—CANDLESTICK—Plated.**  
Simpson, Hall, Miller & Co., Montreal. *Advt. p. 203.*
- 600—CANDLESTICKS—Church.** *See No. 480.*
- 601—CANE—Chair.**  
American Rattan Co., Toronto, Ont.
- 602—CANNONS—Yacht.**  
McAvity T. & Sons, St. Johns, N. B. *Advt. p. 153.*
- 603—CANISTERS—Shelf.**  
Macdonald Mfg Co., Toronto, Ont.
- 604—CANOES—Paddling, Sailing.**  
Gilbert, N. Boat Co., Brockville, Ont. *Advt. p. 254.*  
Knapp, A. C., Kingston, Ont. *Advt. page 229.*  
Canadian Canoe Co., Ltd., Peterboro, Ont.
- 605—CANOPIES—(Canvass), Sidewalk.**  
Soper, R., Hamilton, Ont. *Advt. page 229.*
- 606—CANOPY—(Metal), Bigley's Ventilating.**  
Bigley, R., Toronto, Ont. *Advt. page 242.*

- 607—CANS—Shipping, (Wood).**  
Cane & Sons Mfg Co. Ltd., (The Wm.), Newmarket, Ont. *Advt. page 218.*
- 608—CANS—(Tin), Lobster, Fish.**  
Hemlow & McDiarmid, Liscomb, N. S.  
Smith, Theodore F. & Co., Noody Quoddy, N. S.
- 609—CANS—(Oil), Bicycle.**  
Goold Bicycle Co. Ltd., Brantford, Ont. *Advt. p. 220.*
- 610—CANS—(Oil), Paragon.**  
Paragon Oil Can Co., Montreal, Que.
- 611—CANNED FRUITS & VEGETABLES—Apples, Cherries, Peaches, Pears, Plums, Pine Apples, Raspberries, Strawberries.**  
Miller & Co., Trenton, Ont. *Advt. page 236.*  
Miller, A. C. & Co., Picton, Ont. *Advt. page 236.*  
Erie Preserving Co., St. Catharines, Ont.  
Delhi Fruit & Vegetable Canning Co., Delhi, Ont.  
Aylmer Canning Co., Aylmer, Ont.  
Strathroy Canning Co., Strathroy, Ont.  
Forrest Canning Co., Halifax, N. S.
- 612—CANNED POULTRY—Chicken, Goose, Turkey.**  
Miller & Co., Trenton, Ont. *Advt. page 236.*  
Miller, A. C. & Co., Picton, Ont. *Advt. page 236.*  
Aylmer Canning Co., Aylmer, Ont.  
Strathroy Canning Co., Strathroy, Ont.
- 613—CANS—Honey.**  
Phillips, T. & Co., Orillia, Ont. *Advt. page 259.*  
Goold, Shapely & Muir, Brantford, Ont. *Advt. p. 191.*
- 614—CANS—(Glass), Fruit.**  
Diamond Glass Works, Montreal, Que.
- 615—CANS—(Tin), Baking Powder, Drug-gists', Paint.**  
Marton Mfg Co. (The), Hamilton, Ont.  
Kemp Mfg Co., Toronto, Ont.  
Macdonald Mfg Co., Toronto, Ont.  
Toronto Can Co., Toronto, Ont.  
Davidson, (Thos.) Mfg Co., Montreal, Que. *Advt. 225.*
- 616—CANS—Pill (Glass).**  
Diamond Glass Works, Montreal, Que.
- 617—CANS—(Tin), Garbage, Sewing Machine Oil, Sprinkling, Ice Cream, Machinists' Oil, Lard, Milk,**  
Davidson, (Thos.) Mfg Co., Montreal, Que. *Advt. 225.*  
Chown, W. W. & Co., Belleville, Ont. *Advt. p. 233.*
- 618—CANS—(Oil), Brass, Copper, Engineers', Railway.**  
Chadwick Bros., Hamilton, Ont. *Advt. page 206.*  
American Copper Co., Toronto, Ont. *Advt. p. 157.*  
Hamilton Brass Mfg Co., Hamilton, Ont. *Advt. p. 168.*  
Mitchell, Robert & Co., Montreal, Que. *Advt. p. 213.*  
Coulter & Campbell, Toronto, Ont. *Advt. p. 201.*  
Booth Copper Co., Toronto, Ont. *Advt. page 155.*
- 619—CANTERS—Log.**  
Hamilton Mfg Co. Ltd. (Wm.), Peterboro, Ont.  
Canadian Locomotive & Engine Co. Ltd., Kingston, Ont. *Advt. page 175.*

**620—CANTERS—Steam & Friction Log.**

Hamilton Mfg Co. Ltd, (Wm.), Peterboro, Ont.

**621—CAPS—Blasting.**Dominion Cartridge Co., Montreal, Que. *Advt. p. 196.***622—CAPS—(Iron) Chimney, Window, Hitching Post.**

Garth & Co., Montreal, Que. *Advt. page 154.*  
 Carrier, Laine & Co., Levis, Que. *Advt. page 150.*  
 Gurney Foundry Co. Ltd., Toronto, Ont.  
 Woodyatt, A. R. & Co., Guelph, Ont. *Advt. p. 207.*  
 Loignon, A. & E., Montreal, Que. *Advt. page 247.*  
 Ives, H. R. & Co., Montreal, Que. *Advt. page 200.*

**623—CAPS—Vent, (Iron).**

Garth & Co., Montreal, Que. *Advt. page 154.*  
 Woodyatt, A. R. & Co., Guelph, Ont. *Advt. page 207.*  
 Young & Bro. Co. Ltd., Hamilton, Ont. *Advt. 257.*  
 Ives, H. R. & Co., Montreal, Que. *Advt. page 200.*

**624—CAPS—(Stoneware), Carboy.**

Brantford Stoneware Mfg Co. Ltd. (The), Brantford, Ont. *Advt. page 251.*  
 Hart Bros. & Lazier, Belleville, Ont. *Advt. page 230.*  
 Glass Bros. & Co., London, Ont.  
 Farrar, E. L., Iberville, Que.

**625—CAPS—Knee, (Elastic).**

Gross, F., Montreal, Que.

**626—CAPS—Cape, (Rubber).**

Toronto Rubber Co. Ltd. (The), Toronto Ont.

**627—CAPSTANS—Bar, Crank, Hand, Horse & Steam.**

Carrier, Laine & Co., Levis, Que. *Advt. page 150.*  
 Matheson, I. & Co., New Glasgow, N. S. *Advt. p. 200.*  
 Macdonald & Co., Halifax, N. S. *Advt. page 256.*

**628—CAPS & CAPSULES—(Metal), Bottle.**

Harris, C. C., Toronto, Ont.

**629—CAPSULES—(Bottle), Veneer.**

Kean, Frank, Orillia, Ont. *Advt. page 217.*  
 Belleville Box & Basket Co. Ltd. (The), Belleville, Ont. *Advt. page 234.*

**630—CAPSULES—Cork.**

Canada Cork Cutting Co., Montreal, Que. *Advt. p. 223.*  
 Cork Co. of Canada Ltd., Toronto, Ont. *Advt. p. 187.*  
 Doyle, J. E. & Co., Montreal, Que. *Advt. p. 234.*  
 Freyseng, P. & Co., Toronto, Ont. *Advt. page 235.*

**631—CAPSULES—Gelatine.**Stearns, Fredr. & Co., Windsor, Ont. *See back cover.***632—CAPSULES—Quinine S.E., Quinine H.F., Filled & Empty.**

Parke, Davis &amp; Co., Walkerville, Ont.

**633—CARBONATE—Copper, Iron, Magnesia, Soda, Zinc.**

Lyman Bros. & Co. Ltd., Toronto, Ont.  
 Canada Chemical Mfg Co., Toronto, Ont.

**634—CARBONS—Electric Light.**

Ottawa Porcelain Co., Ottawa, Ont.  
 Peterboro Carbon & Porcelain Co., Peterboro, Ont.  
 Royal Electric Co., Montreal, Que.

**635—CARDBOARD—Colored, White.**

Ritchie & Ramsay, Toronto, Ont. *Advt. page 189.*  
 Union Card & Paper Co., Montreal, Que. *Advt. p. 244.*

**636—CARDS—(Mill), Shoddy, Wool, Cotton, Worsted, Felt.**Goldie & McCulloch Co. Ltd., Galt, Ont. *Advt. p. 159.***637—CARDS—Advertising, (Tin).**

Davidson, (Thos.) Mfg Co., Montreal, Que. *Advt. 225.*  
 Macdonald Mfg Co., Toronto, Ont.

**638—CARDS—Playing.**Union Card & Paper Co., Montreal, Que. *Advt. p. 224.***639—CARDS—Wedding, Visiting, At Home, Programme, Show, Sample, Advertising, "Calendars."**

Dominion Engraving Co., Ottawa, Ont. *Advt. p. 186.*  
 Allen, T. C. & Co., Halifax, N. S.  
 Mortimer & Co., Ottawa, Ont.  
 Toronto Lithograph Co., Toronto, Ont.  
 Rolph, Smith & Co., Toronto, Ont.  
 Barclay, Clark & Co., Toronto, Ont.  
 London Printing & Litho. Co., London, Ont.  
 Sabiston Litho. & Pub. Co., Montreal, Que.  
 Hamilton Litho. Co., Hamilton, Ont.  
 Maritime Steam Litho. Co., St. John, N. B.

**640—CARPETS—Axminster, Ingrain, Union, Wool, "Carpet Squares."**

Toronto Carpet Mfg Co., Toronto, Ont. *Advt. p. 186.*  
 Campbell, Archibald, Markham, Ont.

**641—CARPETS—Venitian, Hemp, Jute, "Imperial Wool."**Mitchell, Wm., Cobourg, Ont. *Advt. page 185.***642—CARRIAGES (Steam), Saw Mill.**

Goldie & McCulloch Co. Ltd., Galt, Ont. *Advt. p. 159.*  
 Brush, Geo., Montreal, Que.  
 Hamilton Mfg Co. Ltd. (Wm.), Peterboro, Ont.  
 Canadian Locomotive & Engine Co. Ltd., Kingston, Ont. *Advt. page 175.*  
 Chalifoux, O. & Sons, St. Hyacinthe, Que. *Advt. 233.*

**643—CARRIAGES—(Cone Coupler).**

Cone Coupler Carriage Co., Palsmerston, Ont.

**644—CARRIAGES—(Children's), Perambulators, Velocipedes.**

Gendron Mfg Co. Ltd., Toronto, Ont. *Advt. p. 187.*  
 American Rattan Co., Toronto, Ont.

**645—CARRIAGES—Doll, Toy, Toy Wheel Barrows.**Gendron Mfg Co. Ltd., Toronto, Ont. *Advt. p. 187.***646—CARRIAGES—(Vehicle), Coupe, Kensington, Landau, Surrey, Victorias, Phaetons, Vehicle Cutters.**

Ashley Carriage Works, Belleville, Ont. *Advt. p. 204.*  
 Speight Wagon Co. (The), Markham, Ont. *Advt. 245.*  
 Kingston Vehicle Co. Ltd., Kingston, Ont. *Advt. 202.*  
 Auld, J. W., Hamilton, Ont.  
 Brantford Carriage Co., Brantford, Ont.  
 Canada Carriage Co., Brockville, Ont.  
 Campbell, John, London, Ont.  
 Crothers, Henderson & Wilson, St. John, N. B.

DeWolfe, Son & Co., Halifax, N. S.  
 Duhamel, L., Ottawa, Ont.  
 Dixon, John, Toronto, Ont.  
 Edgecombe & Sons, Fredericton, N. B.  
 Guy, Matthew, Toronto, Ont.  
 Hutchinson & Son, Toronto, Ont.  
 Kelly & Murphy, St. John, N. B.  
 Lariviere, N. & A. C., Montreal, Que.  
 McLaughlin, (The), Carriage Co., Oshawa, Ont.  
 Miner Carriage Mfg Co. Ltd., Granby, Que.  
 Moran, J. H., London, Ont.  
 Price & Shaw, London, Ont.  
 Thompson, W. J. & Sons, London, Ont.  
 Tudhope Carriage Co., Orillia, Ont.

**647—CARRIERS—(Hay), Sling.**

Laing, Ritchie & Co., Essex, Ont. *Advt. page 209.*  
 Proven, J. W., Oshawa, Ont. *Advt. page 210.*  
 Buchanan, M. T., Ingersoll, Ont.

**648—CARRIERS—Trace.**

Burrow, Stewart & Milne, Hamilton, Ont.  
 Kyle, P. Merrickville, Ont.

**649—CARRIERS—Bundle, Cash, Parcel.**

Kimball, S. S., Montreal, Que., *Advt. page 228.*  
 Hamilton Brass Mfg Co., Hamilton, Ont. *Advt. p. 168.*

**650—CARS—Coal Elevator, Drop Bottom, Dump, Hand, Logging, Mill, Yard, Push, Pit, Mine, Ore, Oil, Tank, Acid Tank.**

Crossen Car Mfg Co. Ltd., Cobourg, Ont. *Advt. p. 160.*  
 Rhodes, Curry & Co. Ltd., Amherst, N. S. *Advt. 158.*  
 Jenckes Machine Co., Sherbrooke, Que. *Advt. p. 165.*  
 Ingersoll Rock Drill Co., Montreal, Que. *Advt. p. 198.*  
 Rathbun Co. (The), Deseronto, Ont. *Advt. page 162.*  
 Canadian Locomotive & Engine Co. Ltd., Kingston, Ont. *Advt. page 175.*  
 Brown, (G. & J.) Mfg Co., Belleville, Ont. *Advt. p. 198.*

**651—CARS—Street Railway, Electric, Cable.**

Rhodes, Curry & Co. Ltd., Amherst, N. S. *Advt. 158.*  
 Crossen Car Mfg Co. Ltd., Cobourg, Ont. *Advt. p. 160.*  
 Lariviere, N. & A. C., Montreal, Que.  
 Ottawa Car Co. Ltd. (The), Ottawa, Ont.  
 Patterson & Corbin, St. Catharines, Ont.

**652—CARS—Steam Shovel.**

Beatty, M. & Sons, Welland, Ont. *Advt. p. 173.*  
 Carrier, Laine & Co., Levis, Que. *Advt. page 150.*  
 Rathbun Co. (The), Deseronto, Ont. *Advt. page 162.*

**653—CARETTES.**

St. Charles & Pringle, Belleville, Ont.

**654—CARMELS.**

McCormick Mfg Co. Ltd., London, Ont.

**655—CARS—Passenger Elevator.**

Myers, W. F. & J. W., St. John, N. B. *Advt. p. 163.*  
 Miller Bros. & Toms, Montreal, Que. *Advt. page 197.*  
 Kerr & Morgan, Montreal, Que. *Advt. page 220.*  
 Fensom, John, Toronto, Ont.

**656—CARS—Parlor, Horse, Cattle, Freight, Box, Flat, Coal, Refrigerator, Live Stock, Colonists, Passenger, Sleeping, Dining, Drawing Room, Vestibule, Baggage, Mail-Road Plasters', Superintendents', Der-**

**rick, Construction, Observation, Excursion, Caboose, Wrecking.**

Rhodes, Curry & Co. Ltd., Amherst, N. S. *Advt. 158.*  
 Crossen Car Mfg Co. Ltd., Cobourg, Ont. *Advt. p. 160.*  
 Rathbun Co. (The), Deseronto, Ont. *Advt. page 162.*

**657—CARTRIDGES—Shot Gun, Rifle, Metallic.**

Dominion Cartridge Co., Montreal, Que. *Advt. p. 196.*

**658—CARTS—(Road), Speeding.**

Speight Wagon Co., Markham, Ont. *Advt. page 245.*  
 Campbell, John, London, Ont.  
 Ashley Carriage Works, Belleville, Ont. *Advt. p. 204.*  
 Miner Carriage Mfg Co. Ltd. (The), Granby, Que.  
 Auld, J. W., Hamilton, Ont.  
 Ramsay, William, Orillia, Ont.  
 Dixon, Jno. H., Toronto, Ont.

**659—CARTS—(Horse), Coal, Corporation, Dump, Railroad, Contractors', Ox, Village.**

Smith Bros., Toronto, Ont. *Advt. page 178.*  
 Campbell, J., London, Ont.  
 Bain Bros. Mfg Co. Ltd., Brantford, Ont. *Advt. 249.*  
 Chatham Mfg Co. Ltd., Chatham, Ont. *Advt. p. 245.*  
 Dixon, Jno. H., Toronto, Ont.  
 Speight Wagon Co., Markham, Ont. *Advt. page 245.*

**660—CARTS—"Perry."**

Ashley Carriage Works, Belleville, Ont. *Advt. p. 204.*

**661—CARTS—Dog.**

Canada Carriage Co., Brockville, Ont.

**662—CARTS—Metal Toy.**

Ives, H. R. & Co., Montreal, Que. *Advt. page 200.*

**663—CARTS—(Hand), Railroad, Peddlers', Hose, Merchants', Post Office, Express.**

Smith Bros., Toronto, Ont. *Advt. page 178.*  
 Dixon, Jno. H., Toronto, Ont.

**664—CASCARA—Stearns's Aromatic.**

Stearns, Fred'k. & Co., Windsor, Ont. *See back cover.*

**665—CASES—Watch.**

American Watch Case Co., Toronto, Ont.  
 Montreal Watch Case Co., Montreal, Que.

**666—CASES—(Show) Biscuit, Grocers', Jewelers', Revolving.,**

Tees & Co., Montreal, Que. *Advt. page 225.*  
 Montreal Show Case Co., Montreal, Que. *Advt. p. 246.*

**667—CASES—(Book) Library, Cabinet, Revolving, Cylinder.**

Canadian Office & School Furniture Co. Ltd. (The),  
 Preston, Ont. *Advt. page 210.*  
 Tees & Co., Montreal, Que. *Advt. page 225.*

**668—CASES—Burial. See Caskets No. 679.**

**669—CASES—Plush, Fancy, Toilet, Jewelry.**

Barber & Ellis Co., Toronto, Ont. *Advt. page 192.*  
 Reinhardt Mfg Co., Montreal, Que.  
 Carstens Mfg Co. (F.), Montreal, Que.  
 Hemming Bros. Co. Ltd., Toronto, Ont.

**670—CASES—Egg.**

Miller Bros. & Co., Montreal, Que. *Advt. page 192.*

- Gilmour & Co., Trenton, Ont.  
Ontario Box Co. Ltd. Hamilton, Ont.
- 671—CASES—Packing (in Shooks)**  
Gravel Lumber Co. (A.), Etchemin, Que. *Advt. p. 215.*  
Rathbun Co. (The), Deseronto, Ont. *Advt. page 162.*  
Edson Fitch Co. (The), Etchemin, Que.
- 672—CASES—Mailing.**  
Somerville, C. R., London, Ont. *Advt. page 235.*  
Brantford Box Co., Brantford, Ont.  
Wilson, J. C. & Co., Montreal, Que.
- 673—CASES—Cartridge.**  
Dominion Cartridge Co., Montreal, Que. *Advt. p. 196.*
- 674—CASES—Bicycle.**  
Morrow Machine Screw Co. (John), Ingersoll, Ont.  
*Advt. page 260.*
- 675—CASES—Rattan Book.**  
Gendron Mfg Co., Ltd. Toronto, Ont. *Advt. p. 187.*
- 676—CASES & BOXES—(Shipping), Merchandise, Dry Goods, Liquor, Organ, Piano, Packing.** *See Boxes No. 414.*
- 677—CASINGS—Metal Window.**  
Metallic Roofing Co. of Canada Ltd. (The), Toronto, Ont. *See front fly leaf.*
- 678—CASKETS—Lead.**  
Morrison, (Jas.) Mfg Co., Toronto, Ont. *Advt. p. 157.*
- 679—CASKETS—Cloth Covered, Burial, Var-nished, Burial Cases, Coffins.**  
Christie, Bros. & Co., Amherst, N. S. *Advt. p. 232.*  
Tees & Co., Montreal, Que. *Advt. page 225.*  
Globe Casket Co., London, Ont.  
Thompson, D. W. & Co., Toronto, Ont.  
Philp & Eckhart, Toronto, Ont.  
Simmens & Evel, Hamilton, Ont.  
Girard, Leopold, Three Rivers, Que.
- 680—CASSIMERES.**  
Ferguson & Pattinson, Preston, Ont.
- 681—CASTERS—Plated.**  
Simpson, Hall, Miller & Co., Montreal, Que.  
*Advt. page 203.*
- 682—CASTERS—(Iron), Curd Sink, Furni-ture, Organ, Piano, Truck, Table Slide.**  
Smart, (Jas.) Mfg Co., Brockville, Ont. *Advt. p. 178.*  
Garth & Co., Montreal, Que. *Advt. page 154.*  
Ives, H. R. & Co., Montreal, Que. *Advt. page 200.*
- 683—CASTERS—Glass.**  
Dominion Glass Works, Montreal, Que. *Advt. p. 221.*
- 684—CASTERS—Spring Locket, Plate, Bed.**  
Ives, H. R. & Co., Montreal, Que. *Advt. page 200.*
- 685—CASTINGS—Lime Kiln.**  
Waring, White & Co., St. John, N. B. *Advt. p. 256.*
- 686—CASTINGS—Incinerator, Steam Barge.**  
Carrier, Laine & Co., Levis, Que. *Advt. page 150.*
- 687—CASTINGS—Tin.**  
Coulter & Campbell, Toronto, Ont. *Advt. page 201.*

- 688—CASTINGS—Barge.**  
Carrier, Laine & Co., Levis, Que. *Advt. page 150.*  
Raney, Reid & Selby, Kingston, Ont.
- 689—CASTINGS—White Iron.**  
Burrow, Stewart & Milne, Hamilton, Ont.  
Malleable Iron Co., Montreal, Que.
- 690—CASTINGS—Sewing Machine.**  
Raymond, Charles, Guelph, Ont.
- 691—CASTINGS—(Brass), Journal.**  
Skinner & Co., Gananoque, Ont. *Advt. page 255.*
- 692—CASTINGS—Office Chair.**  
Carrier, Laine & Co., Levis, Que. *Advt. page 150.*  
Gowdy Mfg Co., Guelph, Ont.
- 693—CASTINGS—(Brass), Machinery.**  
Skinner & Co., Gananoque, Ont. *Advt. page 255.*
- 694—CASTINGS—Iron Machinery.**  
Gardner, R. & Son, Montreal, Que.
- 695—CASTINGS—(Cast Iron), Agricultural Machinery.**  
Moody, Matthew & Sons, Terrebonne, Que.  
*Advt. page 209.*  
Chalifoux, O. & Sons, St. Hyacinthe, Que.  
*Advt. page 232.*  
Carrier, Laine & Co., Levis, Que. *Advt. page 150.*  
Hamilton, Peter Mfg Co., Peterboro, Ont. *Advt. 209.*  
Maxwell, David & Sons, St. Marys, Ont. *Advt. 250.*
- 696—CASTINGS—Plow.**  
Windsor Foundry Co., Windsor, N. S.  
Carrier, Laine & Co., Levis, Que. *Advt. page 150.*
- 697—CASTINGS—Zinc.**  
Macdonald & Co. Ltd., Halifax, N. S. *Advt. p. 256.*  
Coulter & Campbell, Toronto, Ont. *Advt. page 201.*  
Dean, Thomas, Toronto, Ont.  
Parker, J. O. & Co., Toronto, Ont. *Advt. page 253.*
- 698—CASTINGS—Furnace, Iron Furnace.**  
Gurney, Tilden Co. Ltd., Hamilton, Ont. *Advt. p. 151.*  
Gurney Foundry Co. Ltd., Toronto, Ont.  
Star Iron Co., Montreal, Que. *Advt. page 243.*  
Carrier, Laine & Co., Levis, Que. *Advt. page 150.*  
Canadian Locomotive & Engine Co. Ltd., Kingston, Ont. *Advt. page 175.*  
Parker, Moses, Montreal, Que. *Advt. page 197.*  
Crossman & Laws, Amherst, N. S. *Advt. page 226.*
- 699—CASTINGS—See Water Works No. 707.**
- 700—CASTINGS—(Malleable) Carriage, Agri-cultural.**  
Frost, W. H., Smith's Falls, Ont.  
Burrow, Stewart & Milne, Hamilton, Ont.  
Malleable Iron Co., Montreal, Que.  
Walkerville Malleable Iron Co., Walkerville, Ont.  
Kyle, P., Merrickville, Ont.
- 701—CASTINGS—School Desk, Chair, Church Seat End.**  
Smart, (Jas.) Mfg Co., Brockville, Ont. *Advt. page 178.*  
Carrier, Laine & Co., Levis, Que. *Advt. page 150.*  
Crossman & Laws, Amherst, N. S. *Advt. page 226.*  
Parker, Moses, Montreal, Que. *Advt. page 197.*  
Burrow, Stewart & Milne, Hamilton, Ont.

Valleyfield Foundry & Machine Works, Valleyfield, Que. *Advt. page 191.*  
Woodyatt, A. R. & Co., Guelph, Ont. *Advt. p. 207.*  
Ives, H. R. & Co., Montreal, Que. *Advt. page 200.*

#### 702—CASTINGS—Windmill.

Carrier, Laine & Co., Levis, Que. *Advt. page 150.*  
Wortman & Ward Mfg Co., London, Ont.

#### 703—CASTINGS—Bakers' Oven, Coke Oven.

Gurney, Tilden Co. Ltd., Hamilton, Ont. *Advt. 151.*  
Smart, (Jas.) Mfg Co., Brockville, Ont. *Advt. p. 178.*  
Parker, Moses, Montreal, Que. *Advt. page 197.*  
Gurney Foundry Co. Ltd., Toronto, Ont.  
Ives, H. R. & Co., Montreal, Que. *Advt. page 200.*  
Gardner, Robert & Son, Montreal, Que.

#### 704—CASTINGS—Steel.

Carrier, Laine & Co., Levis, Que. *Advt. page 150.*  
Canada Spring & Switch Co., Montreal, Que. *Advt. page 217.*

#### 705—CASTINGS—Ship.

Carrier, Laine & Co., Levis, Que. *Advt. page 150.*  
Parker, Moses, Montreal, Que. *Advt. page 197.*  
Fleck, Alex. Jr., Ottawa, Ont. *Advt. page 252.*  
Windsor Foundry Co., Windsor, N. S.  
Lunenburg Iron Co. Ltd., Lunenburg, N. S.  
Raney, Reid & Selby, Kingston, Ont.

#### 706—CASTINGS—Phosphor Bronze. See No. 717.

#### 707—CASTINGS—Water Works, Gas Works.

Laurie Engine Co., Montreal, Que. *Advt. page 179.*  
Fleck, Alex. Jr., Ottawa, Ont. *Advt. page 252.*  
Three Rivers Iron Works, Three Rivers, Que. *Advt. page 179.*  
Parker, Moses, Montreal, Que. *Advt. page 197.*  
Carrier, Laine & Co., Levis, Que. *Advt. page 150.*  
Goldie & McCulloch Co., Galt, Ont. *Advt. page 159.*  
Garth & Co., Montreal, Que. *Advt. page 154.*

#### 708—CASTINGS—Railway Track.

Crossen Car Mfg Co. Ltd., Cobourg, Ont. *Advt. 160.*  
Carrier, Laine & Co., Levis, Que. *Advt. page 150.*  
Fleck, Alex. Jr., Ottawa, Ont. *Advt. page 252.*  
Jenckes Machine Co., Sherbrooke, Ont. *Advt. p. 165.*  
Laurie Engine Co., Montreal, Que. *Advt. page 179.*  
Three Rivers Iron Works, Three Rivers, Que. *Advt. page 179.*  
Parker, Moses, Montreal, Que. *Advt. page 197.*

#### 709—CASTINGS—Derrick.

Beatty, M. & Sons, Welland, Ont. *Advt. page 173.*  
Jenckes Machine Co., Sherbrooke, Que. *Advt. p. 165.*  
Miller Bros. & Toms, Montreal, Que. *Advt. page 197.*  
Fleck, Alex. Jr., Ottawa, Ont. *Advt. page 252.*  
Kerr & Morgan, Montreal, Que. *Advt. page 220.*  
Parker, Moses, Montreal, Que. *Advt. page 197.*

#### 710—CASTINGS—Stove. See Stoves No. 3316.

#### 711—CASTINGS—Copper. See Brass Castings No. 720

#### 712—CASTINGS—(Machinery), Mill, Saw Mill, Planing Mill, Rolling Mill, Flour Mill.

Bertram, John & Sons, Dundas, Ont. *Advt. p. 161.*  
Canadian Locomotive & Engine Co., Kingston, Ont. *Advt. page 175.*  
Goldie & McCulloch Co. Ltd., Galt, Ont. *Advt. 159.*  
Jenckes Machine Co., Sherbrooke, Que. *Advt. p. 165.*  
Macdonald & Co. Ltd., Halifax, N. S. *Advt. p. 256.*

Carrier, Laine & Co., Levis, Que. *Advt. page 150.*  
Parker, Moses, Montreal, Que., *Advt. page 197.*  
Fleck, Alex. Jr., Ottawa, Ont. *Advt. page 252.*  
Burrell, Johnson Iron Co., Yarmouth, N. S.  
Laurie Engine Co., Montreal, Que. *Advt. page 179.*  
Hamilton Mfg Co. Ltd. (Wm.), Peterboro, Ont.  
Brown, (G. & J.) Mfg Co., Belleville, Ont. *Advt. p. 198.*

#### 713—CASTINGS—Elevator.

Carrier, Laine & Co., Levis, Que. *Advt. page 150.*  
Kerr & Morgan, Montreal, Que. *Advt. page 220.*  
Miller Bros. & Toms, Montreal, Que. *Advt. page 197.*  
Leitch & Turnbull, Hamilton, Ont.  
Fensom, John, Toronto, Ont.  
Myers, W. F. & J. W., St. John, N. B. *Advt. p. 163.*

#### 714—CASTINGS—Car, Street Car.

Canadian Locomotive & Engine Co. Ltd., Kingston, Ont. *Advt. page 175.*  
Carrier, Laine & Co., Levis, Que. *Advt. page 150.*  
Crossen Car Mfg Co. Ltd., Cobourg, Ont. *Advt. p. 160.*  
Fleck, Alex. Jr., Ottawa, Ont. *Advt. page 252.*  
Parker, Moses, Montreal, Que. *Advt. page 197.*  
Rhodes, Curry & Co. Ltd., Amherst, N. S. *Advt. 158.*

#### 715—CASTINGS—Engine, Locomotive.

Canadian Locomotive & Engine Co. Ltd., Kingston, Ont. *Advt. page 175.*  
Carrier, Laine & Co., Levis, Que. *Advt. page 150.*  
Matheson, I. & Co., New Glasgow, N. S. *Advt. p. 200.*  
Jenckes Machine Co., Sherbrooke, Que. *Advt. p. 165.*  
Laurie Engine Co., Montreal, Que. *Advt. page 179.*  
Fleck, Alex. Jr., Ottawa, Ont. *Advt. page 252.*  
Parker, Moses, Montreal, Que. *Advt. page 197.*  
Brown, (G. & J.) Mfg Co., Belleville, Ont. *Advt. 198.*

#### 716—CASTINGS—Building, Store Front.

Carrier, Laine & Co., Levis, Que. *Advt. page 150.*  
Dominion Bridge Co. Ltd., Montreal, Que. *Advt. 195.*  
Fleck, Alex. Jr., Ottawa, Ont. *Advt. page 252.*  
Loignon, A. & E., Montreal, Que. *Advt. page 247.*  
Parker, Moses, Montreal, Que. *Advt. page 197.*  
Gurney Foundry Co. Ltd., Toronto, Ont.

#### 717—CASTINGS—Bronze, Phosphor Bronze.

Macdonald & Co. Ltd., Halifax, N. S. *Advt. p. 256.*  
Canadian Locomotive & Engine Co. Ltd., Kingston, Ont. *Advt. page 175.*  
Carrier, Laine & Co., Levis, Que. *Advt. page 150.*  
Coulter & Campbell, Toronto, Ont. *Advt. page 201.*  
Fraser Bros., New Glasgow, N. S. *Advt. page 252.*  
Parker, J. G. & Co., Toronto, Ont. *Advt. page 253.*  
Morrison, (James) Mfg Co., Toronto, Ont. *Advt. 157.*  
Mitchell, Robert & Co., Montreal, Que. *Advt. p. 213.*

#### 718—CASTINGS—Bridge & Bridge Pier.

Canadian Locomotive & Engine Co. Ltd., Kingston, Ont. *Advt. page 175.*  
Carrier, Laine & Co., Levis, Que. *Advt. page 150.*  
Fleck, Alex. Jr., Ottawa, Ont. *Advt. page 252.*  
Central Bridge & Engineering Co., Peterborough, Ont. *Advt. page 214.*  
Parker, Moses, Montreal, Que. *Advt. page 197.*  
Matheson, I. & Co., New Glasgow, N. S. *Advt. p. 200.*  
Loignon, A. & E., Montreal, Que. *Advt. page 247.*  
Jenckes Machine Co., Sherbrooke, Que. *Advt. p. 165.*  
Dominion Bridge Co., Montreal, Que. *Advt. page 195.*

#### 719—CASTINGS—Malleable Hame.

Kyle, P., Merrickville, Ont.  
Frost, W. H., Smith's Falls, Ont.

**720—CASTINGS—Art Brass, Copper.**

Garth & Co., Montreal, Que. *Advt. page 154.*  
 Carrier, Laine & Co., Levis, Que. *Advt. page 150.*  
 Booth Copper Co., Toronto, Ont. *Advt. page 155.*  
 Coulter & Campbell, Toronto, Ont. *Advt. page 201.*  
 Fleck, Alex. Jr., Ottawa, Ont. *Advt. page 252.*  
 Parker, J. O. & Co., Toronto, Ont. *Advt. page 253.*  
 Fraser Bros., New Glasgow, N. S. *Advt. page 252.*  
 American Copper Co., Toronto, Ont. *Advt. page 157.*  
 Hamilton Brass Mfg Co., Hamilton, Ont. *Advt. p. 168.*  
 Jenckes Machine Co., Sherbrooke, Que. *Advt. p. 165.*  
 Laurie Engine Co., Montreal, Que. *Advt. page 179.*  
 Matheson, I. & Co., New Glasgow, N. S. *Advt. p. 200.*  
 McAvity, T. & Sons, St. John, N. B. *Advt. page 153.*  
 Mitchell, Robert & Co., Montreal, Que. *Advt. p. 213.*  
 Morrison, James Mfg Co., Toronto, Ont. *Advt. p. 157.*  
 Skinner & Co., Gananoque, Ont. *Advt. page 255.*  
 Woodyatt, A. R. & Co., Guelph, Ont. *Advt. p. 207.*

**721—CASTINGS—Grey Iron, Light Iron.**

Ives, H. R. & Co., Montreal, Que. *Advt. page 200.*  
 Carrier, Laine & Co., Levis, Que. *Advt. page 150.*  
 Beer & Calder, Toronto, Ont.  
 Woodyatt, A. R. & Co., Guelph, Ont. *Advt. p. 207.*  
 Chalifoux, O & Sons, St. Hyacinthe, Que. *Advt. 232.*  
 Young & Bro, Co. Ltd., Hamilton, Ont. *Advt. pt 257.*  
 Truro Foundry & Machine Co., Truro, N. S.  
*Advt. page 198.*  
 Gurney, Tilden Co. Ltd., Hamilton, Ont. *Advt. p. 151.*  
 Gowdy Mfg Co., Guelph, Ont.

**722—CASTINGS—Iron, Heavy Iron, Gun Metal**

Parker, Moses, Montreal, Que. *Advt. page 197.*  
 Brown, (G. & J.) Mfg Co., Belleville, Ont. *Advt. 198.*  
 Bertram, John & Sons, Dundas, Ont. *Advt. page 161.*  
 Rodden, Wm. & Co., Montreal, Que.  
 Wilson, J. C. & Co., Glenora, Ont.  
 Carrier, Laine & Co., Levis, Que. *Advt. page 150.*  
 Crossman & Laws, Amherst, N. S. *Advt. page 226.*  
 Kerr Engine Co. Ltd., Walkerville, Ont. *Advt. p. 208.*  
 Laurie Engine Co., Montreal, Que. *Advt. page 179.*  
 Fleck, Alex. Jr., Ottawa, Ont., *Advt. page 252.*  
 Flemming, James, St. John, N. B.  
 Fraser Bros., New Glasgow, N. S. *Advt. page 252.*  
 Three Rivers Iron Works, Three Rivers, Que.  
*Advt. page 179.*  
 Jenckes Machine Co., Sherbrooke, Que. *Advt. p. 165.*  
 Joliette Foundry Co., Joliette, Que.  
 Ives, H. R. & Co., Montreal, Que. *Advt. page 200.*

**723—CATCHES—Shaft Hold Back.**

McKinnon Dash & Hardware Co., St. Catharines, Ont. *Advt. page 202.*

**724—CATCHES—Barn Door, Screen Door, Transom, Cupboard. See Latches No. 1942.****725—CATHETERS—Rubber.**

Alpha Rubber Co. Ltd., Montreal, Que.

**726—CATSUP—Tomato, Mushroom, Walnut.**

Miller & Co., Trenton, Ont. *Advt. page 236.*  
 Strathroy Canning Co., Strathroy, Ont.  
 Garden City Canning Co., St. Catharines, Ont.  
 Ontario Pure Food Co., St. Catharines, Ont.  
 Lakeport Preserving Co., Trenton, Ont.  
 Aylmer Canning Co., Aylmer, Ont.  
 Lytle, T. A. & Co., Toronto, Ont.  
 Jonas, Henri & Co., Montreal, Que.

**727—CEILING—(Wood), Dressed, Matched.**

Edwards, W. C. & Co. Ltd., Ottawa, Ont. *Advt. p. 219.*

Gravel, A. Lumber Co., Etchemin, Que. *Advt. p. 215.*  
 Copping, William, Joliette, Que.  
 Pembroke Lumber Co., Pembroke, Ont. *Advt. 216.*  
 Rhodes, Curry & Co., Amherst, N. S. *Advt. p. 158.*  
 Rathbun Co. (The), Deseronto, Ont. *Advt. p. 162.*

**728—CEILING—Terra Cotta.**

Montreal Terra Cotta & Lumber Mfg Co., Montreal, Que. *Advt. page 214.*  
 Rathbun (The) Co., Deseronto, Ont. *Advt. p. 162.*

**729—CEILINGS—Metallic.**

Douglass Bros., Toronto, Ont.  
 Metallic Roofing Co. of Canada Ltd., Toronto, Ont.

**730—CEILINGS—Iron & Steel, Decorated Metal, Corrugated.**

Metallic Roofing Co. of Canada Ltd. (The), Toronto, Ont. *See front fly leaf.*

**731—CELLS—Electric Battery, (Stone).**

Campbell, R., Hamilton, Ont. *Advt. page 230.*  
 Glass Bros. & Co., London, Ont.  
 Brantford Stoneware Mfg Co., Brantford, Ont.  
*Advt. page 257.*

**732—CEMENT—Actinolite.**

James, Joseph, Bridgewater, Ont.

**733—CEMENT—Foundry, Furnace, Fireproof.**

Hamilton Facing Mill Co., Hamilton, Ont. *Advt. 163.*

**734—CEMENT—Stove, (Prepared.)**

Canada Paint Co. Ltd., Montreal, Que. *Advt. p. 221.*

**735—CEMENT—Gasfitter's.**

Young & Bro. Co. Ltd., Hamilton, Ont. *Advt. p. 257.*

**736—CEMENT—Bicycle.**

Goold Bicycle Co. Ltd, Brantford, Ont. *Advt. p. 220.*

**737—CEMENT—Asphalt, Rosin "Reed's".**

Reed, George W., Montreal, Que. *Advt. page 237.*

**738—CEMENT—Rubber, (Patching).**

Domestic Specialty Co., Hamilton, Ont. *Advt. p. 227.*

**739—CEMENT—Earthenware & Glassware.**

McCrea Hanes Co., Toronto, Ont. *Advt. page 248.*

**740—CEMENT—Rubber.**

Gutta Percha & Rubber Mfg Co. Ltd., Toronto, Ont.  
*See back cover.*  
 Canadian Rubber Co., Montreal & Toronto.  
*Advt. page 197.*

**741—CEMENT—Roofing.**

Reed, George W., Montreal, Que. *Advt. page 237.*  
 Paterson Mfg Co. (The), Montreal, Que.

**742—CEMENT—Leather, Patching, Belt.**

Porter, Henry, Montreal, Que. *Advt. page 239.*  
 Domestic Specialty Co., Hamilton, Ont. *Advt. p. 227.*  
 McLaren Belting Co. (The J. C.), Montreal, Que.  
 Goodhue, J. L., Danville, Que. *Advt. page 236*

**743—CEMENT—Street Paving, Aquaduct, Abutment, Drain Pipe, Foundation.**

Rathbun Co. (The), Deseronto, Ont. *Advt. page 162.*  
 Battle, John (Estate of), Thorold, Ont.

**744—CEMENT—Cistern, Cellar Floor, Arch Sewer, "Acme," Portland, (Star Brand), Napanee.**

Rathbun Co. (The), Deseronto, Ont. *Advt. page 162.*

**745—CENTERS—Bench, Compound, Index, Planer.**

Bertram, John & Sons, Dundas, Ont. *Advt. page 161.*

**746—CENTERS—Neck Yoke.**

Frost, W. H., Smith's Falls, Ont.

**747—CENTERS—Sash.**

Smart, (Jas.) Mfg Co. Brockville, Ont. *Advt. page 178.*

**748—CERATES.**

Stearns, Fred'k. & Co., Windsor, Ont. *See back cover.*

**749—CESSPOOLS—(Iron), Gutter, Stable.**

Dennis Wire & Iron Works, London, Ont. *Advt. 207.*  
Young & Bro. Co. Ltd., Hamilton, Ont. *Advt. p. 257.*  
Garth & Co., Montreal, Que. *Advt. page 154.*

**750—CHAINS—Gauge.**

Ingersoll Rock Drill Co., Montreal, Que. *Advt. 198.*  
Jenckes Machine Co., Sherbrooke, Que. *Advt. p. 165.*

**751—CHAINS—Trace, (Wrought Iron).**

Skinner & Co., Gananoque, Ont. *Advt. page 255.*

**752—CHAINS—Jack.**

Canadian Locomotive & Engine Co., Kingston, Ont. *Advt. page 175.*

**753—CHAINS—Surveyors'.**

Foster, James, Toronto, Ont.

**754—CHAINS—(Brass), Picture, Drapery, Key, Plumbers'.**

McAvity, T. & Son, St. John, N. B. *Advt. page 153.*

**755—CHAINS—Bull, Saw Mill, Steel, Boom, Railway, Mining, Log, Waste.**

Gillies, Geo. Co., Gananoque, Ont. *Advt. page 156.*  
Wallace, William, Three Rivers, Que. *Advt. page 216.*

**756—CHAINS—Hanging Basket, Pump, Halter, Hitching Post, Dog, Crane, Trace.**

Greening Wire Co. Ltd. (The B.), Hamilton, Ont.  
Oneida Community, Niagara Falls, Ont.

**757—CHAINS—Chatelaine, Eye Glass, Necklace, Watch.**

Dominion Rolled Plate Co., Montreal, Que. *Advt. 236.*  
Ellis, P. W. & Co., Toronto, Ont.  
Eastwood, James, New Glasgow, N. S.  
Saunders, H. & A., Toronto, Ont.

**758—CHAIRS—Surgical Dentists.**

Clark Dental Mfg Co. (The), Toronto, Ont.  
Harvard Chair Co. Ltd. (The), Toronto, Ont.

**759—CHAIRS—(Camp), Veneer Patent.**

Moffatt & Co., Carleton Place, Ont.

**760—CHAIRS—(Corner), Bamboo.**

Gendron Mfg Co., Toronto, Ont. *Advt. page 187.*  
Thompson, Alex. & Co., Hamilton, Ont.

**761—CHAIRS—Rocking, (Wilson Rug), Barbers'.**

Ellis Furniture Co. (The), Ingersoll, Ont. *Advt. 208.*

**762—CHAIRS—Jumbo Rocking, Verandah.**

Gelinas, C. P. & Bros., Three Rivers, Que.

**763—CHAIRS—Bent Wood.**

North American Bent Chair Co., Owen Sound, Ont.

**764—CHAIRS—(Head), Railway Track.**

Canada Spring & Switch Co., Montreal, Que. *Advt. page 217.*

**765—CHAIRS—(Car), Railway, Reclining.**

Crossett Car Mfg Co. Ltd., Cobourg, Ont. *Advt. p. 160.*  
Rhodes, Curry Co., Amherst, N. S. *Advt. page 158.*

**766—CHAIRS—(Iron), Lawn, Garden.**

Dennis Wire & Iron Works, London, Ont. *Advt. 207.*

**767—CHAIRS—(Wire), Lawn, Toy, Folding.**

Dennis Wire & Iron Works, London Ont. *Advt. 207.*  
Meadows, George B., Toronto, Ont.

**768—CHAIRS—Antique, Commode.**

Button & Fessant, Wingham, Ont. *Advt. page 251.*

**769—CHAIRS—Folding Camp.**

Globe Furniture Co., Walkerville, Ont. *Advt. p. 225.*  
Office Specialty Mfg Co., Toronto, Ont.  
Otterville Mfg Co., Otterville, Ont. *Advt. page 259.*  
Pike, D., Toronto, Ont.  
Wesley, F. J. & Co., Toronto Junction, Ont.  
Cole's National Mfg Co., Ottawa, Ont.  
Moffatt & Co., Carleton Place, Ont.  
Button & Fessant, Wingham, Ont. *Advt. page 251.*

**770—CHAIRS—Wood Seat.**

Button & Fessant, Wingham, Ont. *Advt. page 251.*  
Valliere, P., Quebec, Que.  
Mabee & Derbyshire, Odessa, Ont.  
Wesley, F. J. & Co., Toronto Junction, Ont.  
Victoriaville Chair Co. Victoriaville, Que.  
Windsor Furniture Co., Windsor, N. S.

**771—CHAIRS—Assembly, Library.**

Canadian Office & School Furniture Co. Ltd. (The), Preston, Ont. *Advt. page 210.*  
Globe Furniture Co., Walkerville, Ont. *Advt. p. 225.*  
Rogers, Charles & Sons Co. Ltd., Toronto, Ont.  
Office Specialty Mfg Co., Toronto, Ont.

**772—CHAIRS—Office, Revolving, Church, Hall, Opera.**

Canadian Office & School Furniture Co. Ltd. (The), Preston, Ont. *Advt. page 210.*  
Globe Furniture Co., Walkerville, Ont. *Advt. p. 225.*  
Ellis Furniture Co., Ingersoll, Ont. *Advt. page 208.*  
Paquet & Godbout, Montreal & St. Hyacinthe, Que.  
Tees & Co., Montreal, Que. *Advt. page 225.*  
Office Specialty Mfg Co., Toronto, Ont.  
Button & Fessant, Wingham, Ont. *Advt. page 251.*  
Windsor Furniture Co., Windsor, N. S.  
Snider, John B., Waterloo, Ont. *Advt. page 231.*

**773—CHAIRS—Adjustable.**

Gendron Mfg Co. Ltd., Toronto, Ont. *Advt. p. 187.*  
American Rattan Co., Toronto, Ont.  
Globe Furniture Co., Walkerville, Ont. *Advt. p. 225.*



**774—CHAIRS—Swing, Children's, Rattan, Reed.**

Gendron Mfg Co. Ltd., Toronto, Ont. *Advt. page 187.*  
American Rattan Co., Toronto, Ont.  
Windsor Furniture Co., Windsor, N. S.

**775—CHAIRS—Invalid, Rolling.**

Gendron Mfg Co. Ltd., Toronto, Ont. *Advt. page 187.*  
American Rattan Co., Toronto, Ont.  
Carlisle, J. & Co., Montreal, Que.

**775 a.—CHAIRS—Step Ladder.**

Gelinas, C. P. & Bro., Three Rivers, Que.  
Turner, J. J. & Son, Peterboro, Ont.  
Royal Mfg Co. (The), Guelph, Ont.

**776—CHALDRONS—Farmers', Butchers'.**

*See No. 1892.*

**777—CHAMOIS—Fibre.**

Canadian Fibre Chamois Co., Montreal, Que.

**778—CHANDELIERS—(Brass & Bronze), Hotel, Hall, Church, Railway Car, (Candelabra).**

Mitchell, Robert & Co., Montreal, Que. *Advt. p. 213.*  
Garth & Co., Montreal, Que. *Advt. page 154.*  
McAvity, T. & Sons, St. John, N. B. *Advt. p. 153.*  
American Copper Co., Toronto, Ont. *Advt. p. 157.*  
Booth Copper Co., Toronto, Ont. *Advt. page 155.*  
Chadwick Bros., Hamilton, Ont. *Advt. page 206.*  
Young & Bros. Co., Hamilton, Ont. *Advt. page 257.*  
Peterboro Lock Mfg Co., Peterboro, Ont. *Advt. p. 219.*

**779—CHANNELS—Steel.**

Central Bridge & Engineering Co. Ltd., Peterborough, Ont. *Advt. page 214.*

**780—CHARMS—Gold & Silver, Watch.**

Ellis, P. W. & Co., Toronto, Ont.  
Saunders, H. & A., Toronto, Ont.

**781—CHARTS—Map.**

Gage Co. Ltd. (W. J.), Toronto, Ont. *Advt. p. 189.*  
Rolph, Smith & Co., Toronto, Ont.

**782—CHASES—Printing Press.**

Westman & Baker, Toronto, Ont.  
Dominion Type Foundry, Montreal, Que.  
Vivian, John H., Toronto, Ont.

**783—CHAUCKS—Ships.**

Lunenburg Iron Co. Ltd., Lunenburg, N. S.

**784—CHECKS—(Baggage), Cloth & Paper.**

Barber & Ellis Co. Ltd., Toronto, Ont. *Advt. p. 192.*

**785—CHECKS—Shuttle, (Woollen Mill).**

Paul Frind Woollen Mach'y Co., Toronto, Ont.  
*Advt. page 249.*

**786—CHECKS—(Metal), Baggage, Hotel, Key, Restaurant, Time, Dog, Tags.**

Garth & Co., Montreal, Que. *Advt. page 154.*  
Pritchard & Andrews, Ottawa, Ont. *Advt. page 250.*  
Peterboro Lock Mfg Co., Peterboro, Ont. *Advt. 219.*  
Morrison, James Brass Mfg Co., Toronto, Ont.  
*Advt. page 157.*  
Patterson & Heward, Toronto, Ont. *Advt. page 201.*  
Chadwick Bros., Hamilton, Ont. *Advt. page 206.*  
Parker, J. O. & Co. Toronto, Ont. *Advt. page 253.*

**787—CHEMICALS—Pharmaceutical, Agricultural.**

Canada Chemica Mfg Co. Ltd., London, Ont.  
Lyman Bros. & Co. Ltd., Toronto, Ont.

**788—CHEMICALS—Electro-Plating, Heavy.**

Canada Chemical Mfg Co. Ltd., Toronto, Ont.

**789—CHEQUES—Blank.**

Mortimer & Co., Ottawa, Ont.

**790—CHESTS—Iron.**

Carrier, Laine & Co., Levis, Que. *Advt. page 150.*

**791—CHESTS—Bolting, (Mill).**

Goldie & McCulloch Co. Ltd., Galt, Ont. *Advt. 159.*

**792—CHESTS—(Tin), Tea.**

Macdonald Mfg Co., Toronto, Ont.

**793—CHEVIOTS—Cotton.**

Gibson, Alex. & Sons Ltd., Marysville, N. B.  
Merritton Cotton Mills Co. Ltd., Merritton, Ont.  
Dominion Cotton Mills Co. Ltd., Montreal, Que.  
*Advt. page 181.*  
Canadian Colored Cotton Mills Co. Ltd. Montreal,  
Que. *Advt. page 181.*

**794—CHIMNEYS—(Lamp), Glass, Flint.**

Lamont Glass Co., New Glasgow, N. S. *Advt. p. 231.*  
Dominion Glass Works, Montreal, Que. *Advt. p. 221.*

**795—CHISELS—Stencil.**

Pritchard & Andrews, Ottawa, Ont. *Advt. page 250.*  
Brown, Boggs & Co., Hamilton, Ont. *Advt. p. 193.*

**796—CHISELS—Cold, Blacksmiths', Chipping, Stone, Track, Farmer.**

Bertram, John & Sons, Dundas, Ont. *Advt. p. 161.*  
Brown, Boggs & Co., Hamilton, Ont. *Advt. p. 193.*  
Whitman & Barnes Mfg Co., St. Catharines, Ont.  
Gardner Tool Co. (W. R.), Brockville, Ont.

**797—CHISELS—Carpenters', Calking, Ice, Socket, Paving, Mortiser.**

Broad, E. & Sons, St. Stephens, N. B.  
Cowan, J., St. John, N. B.  
Warnock, James, Galt, Ont.

**798—CHLORIDE—Lead, Sodium, Lime.**

Canada Chemical Mfg Co. Ltd., London, Ont.  
Lyman Bros. & Co. Ltd., Toronto, Ont.

**799—CHLORIDE—Calcium, Iron, Cadmium, Copper, Silver, Potassium, Gold.**

Lyman Bros. & Co. Ltd., Toronto, Ont.

**800—CHOPPERS—Grain.**

Bessette, J. & S., Iberville, Que.  
Richardson & Webster, St. Mary's, Ont.  
Moody, M. & Sons, Terrebonne, Que. *Advt. p. 209.*  
Maxwell, David & Sons, St. Mary's, Ont. *Advt. 250.*

**801—CHOPPERS—Butchers', Meat, Vegetable.**

Smart Mfg Jas. Co., Brockville, Ont. *Advt. page 178.*  
Ives, H. R. & Co., Montreal, Que. *Advt. p. 200.*

**802—CHOW CHOW.**

Lefebvre, Michel, & Co., Montreal, Que.  
Hamilton Vinegar Works, Hamilton, Ont.

**803—CHROMATE—Iron.**

Lyman Bros. &amp; Co. Ltd., Toronto, Ont.

**804—CHUCKS—Sliding Jaw.**Bertram, John & Sons, Dundas, Ont. *Advt. p. 161.*  
Gardner, R. & Son, Montreal, Que.**805—CHUCKS—Drill, Screw Machine.**Bertram, John & Sons, Dundas, Ont. *Advt. p. 161.*  
Stevens, Hamilton & Co., Galt, Ont.  
Gardner, R. & Son, Montreal, Que.**806—CHUCKS—Shaper, Swivel Base, Self-Centering, Cylinder, Planer, Universal, Turret, Independent, Eccentric, Cutting-Off, Compound Circular, Car Wheel.**Bertram, John & Sons, Dundas, Ont. *Advt. p. 161.*  
Stevens, Hamilton & Co., Galt, Ont.  
Gardner, R. & Son, Montreal, Que.**807—CHUCKS—Wood Lathe.**Bertram, John & Sons, Dundas, Ont. *Advt. p. 161.*  
Stevens, Hamilton & Co. Galt, Ont.  
Bateman, Wm. & Co., Montreal, Que. *Advt. p. 247.***808—CHURNS—Barrel, Factory, Power.**Dowswell Bros. & Co., Hamilton, Ont. *Advt. p. 243.*  
Butcher, F. E., St. Mary's, Ont.  
Richardson & Webster, St. Mary's, Ont.  
Smart Mfg Co. Ltd., Brockville, Ont. *Advt. p. 178.*  
Maxwell, David & Sons, St. Marys, Ont. *Advt. p. 250.***809—CHURNS—Dash.**

Butcher, F. E., St. Mary's, Ont.

**810—CHURNS—Patent Revolving.**

Macpherson &amp; Schell, Alexandria, Ont.

**811—CHURNS—Stoneware.**Brantford Stoneware Mfg Co. Ltd. (The), Brantford, Ont. *Advt. page 251.***812—CHUTES—Mail.**Garth & Co., Montreal, Que. *Advt. page 154.***813—CIDER—Champagne, Apple. See No. 20.****814—CIGARS.**Payne, J. Bruce, Granby, Que.  
Bell Cigar Co. (The), St. John, N. B.  
Brener Bros., London, Ont.  
Davis, S. & Sons, Montreal, Que.  
Empire Tobacco Co., Montreal, Que.  
Smith, A. & Co., London, Ont.  
Tasse, Wood & Co., Montreal, Que.  
Webster, W. R., Sherbrooke, Que.**815—CIGARETTES—Cubeb.**Stearns, Fred'k & Co., Windsor, Ont. *See back cover.***816—CIRCLES—Brass.**Hamilton Brass Mfg Co., Hamilton, Ont. *Advt. 168.*  
McAvity, T. & Sons, St. John, N. B. *Advt. page 153.*  
Coulter & Campbell, Toronto, Ont. *Advt. page 201.*  
Morrison, Jas., Brass Mfg Co., Toronto. *Advt. p. 157.*  
Mitchell, R. & Co., Montreal, Que. *Advt. page 213.***817—CIRCLES—Miners' Dip.**

Foster, James. Toronto, Ont.

**818—CITRATE COMPOUND—Citrate of Ammonium & Iron, Citrate of Iron and Quinine, Citrate of Magnesia, Potassium.**Lyman Sons & Co., Montreal, Que.  
Lyman Bros. & Co. Ltd., Toronto, Ont.**819—CLAMPS—Screw, Adjustable, Vice, 'Mechanists'.**Ives, H. R. & Co., Montreal, Que. *Advt. page 200.*  
Woodyatt, A. R. & Co., Guelph, Ont. *Advt. p. 178.*  
Smart, (Jas.) Mfg Co. Brockville, Ont. *Advt. p. 178.***820—CLAMPS—Sash, Door & Blind.**Ballantine, John & Co., Preston, Ont. *Advt. p. 205.*  
Smart, (Jas.) Mfg Co., Brockville, Ont. *Advt. p. 178.*  
Ives, H. R. & Co., Montreal, Que. *Advt. page 200.***821—CLAMPS—Pump.**McAvity, T. & Sons, St. John, N. B. *Advt. p. 153.***822—CLAMPS—Tire Bolt.**

Butterfield &amp; Co., Rock Island, Que.

**823—CLAMPS—Belt.**Robin, Sadler & Haworth, Montreal, Que. *Advt. 226.*  
McClaren Belting Co. (The J. C.), Montreal, Que.  
Goodhue, J. L. & Co., Danville, Que. *Advt. p. 236.***824—CLAMPS—Plow Colter.**

Gowdy Mfg Co., Guelph, Ont.

**825—CLAMPS—(Wood), Screw.**

Strathroy Mfg Co. Ltd. (The), Strathroy, Ont.

**826—CLAPBOARDS.**Dickson Co. (The), Peterborough, Ont. *Advt. p. 250.*  
Edwards, W. C. & Co. Ltd., Ottawa, Ont. *Advt. p. 219.*  
Pembroke Lumber Co., Pembroke, Ont. *Advt. p. 216.*  
Rhodes, Curry & Co., Amherst N. S. *Advt. page 158.*  
Rathbun Co. (The), Deseronto, Ont. *Advt. page 162.*  
Eastman Lumber Co., Eastman, Que.  
Parker & Howe, Dixville, Que.  
Copping, William, Joliette, Que.  
Cookshire Mills Co., Cookshire, Que.  
Bedard, Joseph, Richmond, Que.  
Cass Bros., Martinville, Que.  
Cushing, Andre & Co., St. John, N. B.  
Lowell, H. & Sons, Coaticooke, Ont.  
Leonard & Morin, Garthly, Que.  
McLachlin Bros., Arnprior, Ont.  
Ritchie, D. & J. Co., Newcastle, N. B.  
Ross, W. H. Sherbrooke, Que.  
Stetson, Cutler & Co., St. John, N. B.  
Tangua, N. P., Weeden, Que.  
Tangua, Chas., Weeden, Que.  
White, A. & P., Pembroke, Ont.  
Willard, J. C. & Sons, Bolton Centre, Que.  
Williamson & Crombie, Kingsbury, Que.**827—CLAMPS—Hose.**Garth & Co., Montreal, Que. *Advt. page 154.***828—CLAPBOARDS—(Metallic, Steel).**Metallic Roofing Co. of Canada, Ltd. (The) Toronto, Ont. *See front fly leaf.***829—CLASPS—Corset, Unbreakable Corset Clasps.**Wilnot Corset Co., South Farmington, N. S.  
St. Lawrence Steel & Wire Co., Gananoque, Ont. *Advt. page 183.*

- 830—CLASPS—Horse Blanket, Garment.**  
Parmenter & Bulloch, Gananoque, Ont. *Advt. p. 199.*
- 831—CLAWS—Tack.**  
Smart, (Jas.) Mfg Co., Brockville, Ont. *Advt. p. 178.*
- 832—CLAY—Foundry.**  
Hamilton Facing Mill Co., Hamilton, Ont, *Advt. 193.*  
Hardy & Dubord, Beauport, Que.
- 833—CLAY—Fire.**  
Acadia Coal Co. Ltd., Stellarton, N. S.
- 834—CLEANERS—Corn & Oat.**  
Goldie & McCulloch Co. Ltd., Galt, Ont. *Advt. p. 159.*
- 835—CLEANERS—Drain Tile.**  
Erie Iron Works Mfg Co. Ltd., St. Thomas, Ont.
- 836—CLEANERS—Boiler Flue, Boiler.**  
Garth & Co., Montreal, Que. *Advt. page 154.*  
Macdonald & Co. Ltd., Halifax, N. S. *Advt. page 256.*  
McAvity, T. & Sons, St. John, N. B. *Advt. page 153.*  
Jenckes Machine Co., Sherbrooke, Que. *Advt. p. 165.*  
Hamilton Brass Mfg Co., Hamilton, Ont. *Advt. 168.*  
Morrison, Jas. Brass Mfg Co., Toronto, Ont. *Advt. 157.*  
Robb Engineering Co. Ltd., Amherst, N. S.  
*See inside front cover.*
- 837—CLEATS—Electric Light, Wire Conductor.**  
Ness, McLaren & Bate, Montreal, Que. *Advt. p. 240.*
- 838—CLEATS—(Mooring), Line.**  
Morrison, Jas. Mfg Co., Toronto, Ont. *Advt. p. 157.*  
Ives, H. R. & Co., Montreal, Que. *Advt. page 200.*
- 839—CLEATS—Boat.**  
Raney, Reid & Silby, Kingston, Ont.
- 840—CLEAVERS—Pork Packers, Butchers.**  
Gardner Tool Co. (W. R.), Brockville, Ont.  
Whitman & Barnes Mfg Co., St. Catharines, Ont.
- 841—CLEVISES—Wrought Iron.**  
Skinner & Co., Gananoque, Ont. *Advt. page 255.*
- 842—CLEVISES—Plow, Link, Chain, Evener.**  
Gillies Geo. (The), Co., Gananoque, Ont. *Advt. p. 156.*  
Whitman & Barnes Mfg Co., St. Catharines, Ont.  
Burrow, Stewart & Milne, Hamilton, Ont.  
Frost, W. H., Smith's Falls, Ont.
- 843—CLINCHERS—Horseshoe Nail.**  
Jardine, A. B. & Co., Hespeler, Ont. *Advt. page 217.*
- 844—CLIPPERS—Bolt, Rivet.**  
Gillies, Geo. (The), Co., Gananoque, Ont. *Advt. p. 156.*  
Woodyatt, A. R. & Co., Guelph, Ont. *Advt. p. 207.*  
Butterfield & Co., Rock Island, Que.  
Jardine, A. B. & Co., Hespeler, Ont. *Advt. page 217.*
- 845—CLIPPERS—Dehorning.**  
Kimball, S. S., Montreal, Que. *See page 228.*
- 846—CLIPS—Hame.**  
Skinner & Co., Gananoque, Ont. *See page 255.*
- 847—CLIPS—Curtain.**  
Woodyatt, A. R. & Co., Guelph, Ont. *See page 207.*

- 848—CLIPS—(Iron & Steel), Coach, Fellow, King Bolt, Axle, "Timpkins' Pat."**  
Gillies, Geo. (The) Co., Gananoque, Ont. *See p. 156.*
- 849—CLIPS—Bolt.**  
Swansea Forging Co. Ltd., Swansea, Ont. *See p. 156.*  
Parmenter & Bulloch, Gananoque, Ont. *See page 199.*  
Gillies, Geo. (The) Co., Gananoque, Ont. *See p. 156.*
- 850—CLIPS—Stationers'.**  
Smart, (Jas.) Mfg Co., Brockville, Ont. *See page 178.*  
Brown, C. C., Danville, Que.  
Office Specialty Mfg Co., Toronto, Ont.  
Ives, H. R. & Co., Montreal, Que. *See page 200.*
- 851—CLIPS—Neck Yoke, Carriage (Malleable)**  
Frost, W. H., Smith's Falls, Ont.  
Burrow, Stewart & Milne, Hamilton, Ont.
- 852—CLIPS—Wrought Iron Yoke, Spring, Side Bar, Saddle, Special.**  
Gillies, Geo. (The), Co., Gananoque, Ont. *See p. 156.*  
Swansea Forging Co. Ltd., Swansea, Ont. *See p. 156.*
- 853—CLIPS—Hose.**  
Garth & Co., Montreal, Que. *See page 154.*
- 854—CLIPS—PAPER.**  
Ives, H. R. & Co., Montreal, Que. *See page 200.*
- 855—CLOAKS—Ladies', Misses', Children's, Infants'.**  
Allen Mfg Co., Toronto, Ont.
- 856—CLOCKS—Locomotive & Marine.**  
Morrison, Jas. Brass Mfg Co., Toronto, Ont. *See p. 157.*
- 857—CLOSETS—(Water), Ships, Yachts.**  
Mitchell, Robert & Co., Montreal, Que. *See page 213.*
- 858—CLOSETS—(Iron), Water.**  
Young & Bro. Co. Ltd., Hamilton, Ont. *See p. 257.*
- 859—CLOSETS—(Earth), Automatic, Dry Earth.**  
Gananoque Furniture Co., Gananoque, Ont.  
Marchmont & Co., Toronto, Ont.  
Date, John, Montreal, Que.
- 860—CLOTH—(Wire), Paper Makers', Diaphanous.**  
Forrester, Thos., Montreal, Que. *See front fly leaf.*  
Meadows, George B., Toronto, Ont.
- 861—CLOTH—(Asbestos).**  
Sclater Asbestos Mfg Co., Montreal, Que. *See p. 172.*  
Forrester, Thos., Montreal, Que. *See front fly leaf.*  
Berry, M. B., Quebec, Que.
- 862—CLOTH—(Hair), Padding, (Tailor's), Upholsterers'.**  
Canada Hair Cloth Co., St. Catharines, Ont.
- 863—CLOTH—(Rubber), Organ, Bellows, Patching.**  
Toronto Rubber Co. Ltd. (The), Toronto, Ont.  
Gutta Percha & Rubber Mfg Co. Ltd., Toronto, Ont.  
*See inside back cover.*  
Canadian Rubber Co., Montreal, Que. *See page 197.*

**864—CLOTH—(Wire) Strainer, Spark, Galvanized, Steel, Tinned.**

Meadows, George B., Toronto, Ont.  
Greening Wire Co. Ltd. (The B.), Hamilton, Ont.

**865—CLOTH—(Wire), Crimped, Brass, Window, Screen, Battery, Loom.**

Munro Bros., New Glasgow, N. S. *See page 244.*  
Meadows, George B., Toronto, Ont.  
Greening Wire Co. Ltd. (The B.), Hamilton, Ont.

**866—CLOTH—(Wire), Mill, Threshing Machine, Fanning Mill.**

Greening, T. & Sons, Chatham, Ont.  
Meadows, George B., Toronto, Ont.  
Greening Wire Co. Ltd. (The B.), Hamilton, Ont.

**867—CLOTH—(Wool) Shoe, Jersey, Cloaking, Cheviots, Diagonals, Cashmerette, Ladies', Military, Mantle, Trowsering, Mil-ton, Serges, Costume Plaids.**

Yarmouth Woolen Mills Co., Yarmouth, N. S.  
Brodie & Co., Hespeler, Ont.  
Globe Woolen Mills Co., Montreal, Que.  
Lomas, Adam & Son, Sherbrooke, Que.  
Waterloo Woolen Co. Ltd., Waterloo, Ont.  
Paton Mfg Co., Sherbrooke, Que.  
Rosamond Woolen Co., Almonte, Ont.  
Hawthorne Woolen Co. Ltd., Carleton Place, Ont.

**868—CLOTHING—Macintosh, Waterproof.**

Shorey, H. & Co., Montreal, Que. *See page 227.*  
Globe Rubber Co. (The), Quebec, Que.  
Mackedie, J. W. & Co. Montreal, Que.

**869—CLOTHING—(Oiled) Horse, Oiled Coats.**

Pike, D., Toronto, Ont. *See page 182.*  
Soper, R., Hamilton, Ont. *See page 229.*  
Turner, J. J. & Son, Peterboro, Ont.  
Leckie, J., Toronto, Ont.

**870—CLOTHING—Rubber Horse. *See No. 772.***

**871—CLOTHING—CARD—(Factory).**

McLaren, Belting Co. (The J. C.), Montreal, Que.

**872—CLOTHING—(Rubber) Firemen's, Sport-men's, (Rubber Covers)**

Gutta Percha & Rubber Mfg Co. Ltd., Toronto, Ont. *See inside back cover.*  
Canadian Rubber Co., Montreal, Que. *See page 197.*  
Granby Rubber Co. Ltd., Granby, Que.  
Toronto Rubber Co. (The), Toronto, Ont.

**873—CLOTHING—Ready Made.**

Paquet, Z., Quebec, Que.  
Clayton & Sons, Halifax, N. S.  
Burns & Lewis, London, Ont.  
Shorey, H. & Co., Montreal, Que. *See page 227.*  
Doull & Gibson, Montreal, Que.  
Sanford, W. E. Mfg Co. Ltd., Hamilton, Ont.  
Lailley, Watson & Co., Toronto, Ont.  
Boisseau, E. & Co., Toronto, Ont.  
Horsefall, Joseph & Sons, Montreal, Que.  
Chalcraft, Simpson & Co., Toronto, Ont.  
Mackedie, J. W. & Co., Montreal, Que.  
Johnston, W. R. & Co., Toronto, Ont.  
Calder, John & Co., Hamilton, Ont.

**874—CLUBS—Indian.**

Goulette, O. V. Gananoque, Ont. *See page 214.*  
McLeod Bros., Truro, N. S.

**875—CLUTCHES—Friction, Spring.**

Goldie & McCulloch Co., Galt, Ont. *See page 159.*  
Matheson, I. & Co., New Glasgow, N. S. *See p. 200.*  
Robb Engineering Co. Ltd., Amherst, N. S. *See inside front cover.*

Gardner, Robert & Son, Montreal, Que.

**876—COACHES—Tally Ho. *See No. 646.***

**877—COAL—Charred, Charcoal.**

Rathbun Co. (The), Deseronto, Ont. *See page 162.*

**878—COAL—Bituminous.**

Intercolonial Coal Mining Co. Ltd., Westville, N. S.  
Acadia Coal Co. Ltd., Stellarton, N. S. *See page 162.*  
Dominion Coal Co. Ltd., Glace Bay, C. B.  
Cumberland Railway & Coal Co., Springhill, N. S.

**879—COATING—Wall, Preservative.**

Alabastine Co. Ltd. (The), Paris, Ont. *See page 212.*  
Reed, Geo. W., Montreal, Que. *See page 237.*

**880—COATS—Leather.**

Hudson Bay Knitting Co., Montreal, Que.

**881—COATS—Black Dog Skin.**

Newlands & Co., Galt, Ont.

**882—COCAINE—Hydrochromate, Hydrochlorate, Oleate, Alkaloid, Salicylate.**

Parke, Davis & Co., Walkerville, Ont.

**883—Cockeyes—Wrought Iron.**

Skinner & Co., Gananoque, Ont. *See page 255.*

**884—COCKS—Shaft Head, (Vehicle).**

Houghton Mfg Co., Paris, Ont.

**885—COCKS—(Iron), Marine Gauge, Self-cleaning, Steam Boiler, Lamp Post.**

Garth & Co., Montreal, Que. *Advt. page 154.*  
McAvity, T. & Sons, St. John, N. B. *Advt. p. 153.*  
Morrison, Jas. Brass Mfg Co., Toronto. *Advt. p. 157.*  
Macdonald & Co. Ltd., Hamilton, N. S. *Advt. p. 256.*

**886—COCKS—(Brass), Ale & Beer, Water, Stop Steam, Self-closing, Lock, Hose, Gauge, Gas, Cylinder, Compression, Asbestos Packed, Angle, Air.**

Hamilton Brass Mfg Co, Hamilton, Ont. *Advt. p. 168.*  
Parker, J. O. & Co., Toronto, Ont. *Advt. page 253.*  
McAvity, T. & Sons, St. John, N. B. *Advt. page 153.*  
Morrison, Jas. Brass Mfg Co., Toronto. *Advt. p. 157.*  
Mitchell, Robert & Co., Montreal, Que. *Advt. p. 213.*  
Garth & Co., Montreal, Que. *Advt. page 154.*

**887—COCK—(Stop), Imperial.**

Garth & Co., Montreal, Que. *Advt. page 154.*

**888—COCOA—Chocolate.**

Todhunter, Mitchell & Co., Toronto, Ont.  
Cowan Co. Ltd. (The), Toronto, Ont.  
Mott, John P. & Co., Halifax, N. S.  
Viau & Bros., Montreal, Que.

**889—COCOANUT—Dessicated, Shreded.**

McCormick Mfg Co. Ltd., London, Ont.  
Moir, Son & Co., Halifax, N. S.  
Schepp, L., Toronto, Ont.

**890—CODES—Signal.**

Montreal Tent, Awning & Tarpaulin Co., Montreal, Que. *Advt. page 232.*  
 Sonne Thomas, Montreal, Que.

**891—COFFEE, COCOA, MILK—(Condensed).**

Truro Condensed Milk Co. Ltd., Truro N. S.  
 Forrest Canning Co., Halifax, N. S.

**892—COFFEE—Fluid.**

Lyman, Sons & Co., Montreal, Que.

**893—COFFEE—Ground.** *See Spices No. 3172.***894—COFFINS—Wood.** *See Caskets No. 679.***895—COGGING—Wood, Cogs, (Maple).**

Fleck, Alex. Ottawa, Ont. *Advt. page 252.*  
 Goldie & McCulloch Co., Galt, Ont. *Advt. page 159.*

**896—COILS—(Iron), Box, Pipe.**

Garth & Co., Montreal, Que. *Advt. page 154.*  
 Macdonald & Co. Ltd., Halifax, N. S. *Advt. p. 256.*  
 Young & Bro. Co. Ltd., Hamilton, Ont. *Advt. p. 257.*

**597—COILS—Wrought Iron Pipe.**

Morrison, Jas. Brass Mfg Co. Toronto, Ont. *Advt. 157.*

**898—COILS—(Rubber), Abdominal.**

Alpha Rubber Co. Ltd., Montreal, Que.

**899—COILS—Induction.**

Ness, McLaren & Bate, Montreal, Que. *Advt. p. 240.*  
 Canadian General Electric Co. Ltd., Toronto, Ont.  
 Toronto Electrical Works, Toronto, Ont.

**900—COILS—Steam, Water.**

Garth & Co., Montreal, Que. *Advt. page 154.*

**901—COILS—Brass, Copper.**

Morrison, Jas. Brass Mfg Co., Toronto, Ont. *Advt. 157.*  
 Hamilton Brass Mfg Co., Hamilton, Ont. *Advt. 168.*  
 Garth & Co., Montreal, Que. *Advt. page 154.*  
 Mitchell, Robert & Co., Montreal, Que. *Advt. p. 213.*  
 Macdonald & Co. Ltd., Halifax, N. S. *Advt. p. 256.*  
 Coulter & Campbell, Toronto, Ont. *Advt. page 201.*  
 Parker, J. O., Toronto, Ont. *Advt. page 253.*

**902—COILERS—Barrel Hoop.**

McKeough & Trotter, Chatham, Ont.

**903—COKE.**

Acadia Coal Co. Ltd., Stellarton, N. S.

**904—COLLARS—(Iron & Steel), Bridge.**

Dominion Bridge Co., Montreal, Que. *Advt. page 195.*  
 Stewart, John & Co., New Glasgow, N. S. *Advt. 222.*  
 Carrier, Laine & Co., Levis, Que. *Advt. page 150.*

**905—COLLARS & CUFFS—Celluloid, (Water-proof).**

Miller Bros. & Co., Montreal, Que. *Advt. p. 192.*  
 Dominion Waterproof Co., Toronto, Ont.

**906—COLLARS—Stove Pipe, (Tin).**

Davidson Mfg Co. (Thos.), Montreal, Que. *Advt. 225.*

**907—COLLARS—Brass Stove Pipe.**

Chadwick Bros., Hamilton, Ont. *Advt. page 206.*  
 Parker, J. O. & Co., Toronto, Ont. *Advt. page 253.*

**908—COLLARS—Fire Department Horse.**

Dennis Wire & Iron Works, London, Ont. *Advt. 207.*

**909—COLLARS—Horse, Mule, Sweat, Ox.**

*See No. 1669.*

**910—COLLARS—Shaft, Clamp.**

Fleck, Alex. Jr., Ottawa, Ont. *Advt. page 252.*  
 Laurie Engine Co., Montreal, Que. *Advt. page 179.*  
 Matheson, I. & Co., New Glasgow, N. S. *Advt. p. 200.*  
 Macdonald & Co. Ltd., Halifax, N. S. *Advt. p. 256.*  
 Brown, (G. & J.) Mfg Co., Belleville, Ont. *Advt. p. 198.*  
 Lancaster Machine Works, Lancaster, Ont. *Advt. 248.*  
 Carrier, Laine & Co., Levis, Que. *Advt. page 150.*  
 Garth & Co., Montreal, Que. *Advt. page 154.*

**911—COLLARS & CUFFS—(Paper) Linen Faced.**

Miller Bros. & Co., Montreal, Que. *Advt. page 192.*

**912—COLLECTORS—Dust.**

Goldie & McCulloch Co. Ltd. Galt, Ont. *Advt. p. 159.*

**913—COLLETS—Bit Brace.**

Jardine, A. B. & Co., Hespeler, Ont. *Advt. page 217.*  
 Butterfield & Co., Rock Island, Que.

**914—COLLODION.**

Lyman, Bros. & Co. Ltd., London, Ont.

**915—COLORS—Confectioners', Bottlers'.**

Seely Mfg Co., Windsor, Ont.

**916—COLORS—Aniline.**

Canada Paint Co. Ltd., Montreal, Que. *Advt. p. 221.*  
 Wright & Dallyn, Hamilton, Ont. *Advt. page 185.*  
 Drouin Bros. & Co., Quebec, Que.  
 Young & Son, Montreal, Que.

**917—COLORS—Artists' Tube.** *See No. 918.***918—COLORS—Artists' Dry, Chromo Photograph, Ceramic, Scene Painters'.**

Canada Paint Co. Ltd., Montreal, Que. *Advt. p. 221.*  
 Howe, William, Ottawa, Ont. *Advt. page 201.*  
 Ramsay, A. & Son, Montreal, Que. *Advt. page 211.*  
 Robertson Co. Ltd. (Jas.), Toronto, Ont. *Advt. p. 167.*  
 McArthur, Corneille & Co., Montreal, Que. *Advt. 221.*

**919—COLORS—Marbleisers', Distemper, Paper Makers', Oil, Japan, Mortar, Graining, Fresco, Decorators', Agricultural.**

Canada Paint Co., Montreal, Que. *Advt. page 221.*  
 Howe, William, Ottawa, Que. *Advt. page 201.*  
 Ramsay, A. & Son, Montreal, Que. *Advt. page 211.*  
 Robertson Co. Ltd. (Jas.), Toronto, Ont. *Advt. p. 167.*  
 Baylis Mfg Co., Montreal, Que.  
 Henderson & Potts, Halifax, N. S.  
 McArthur, Corneille & Co., Montreal, Que. *Advt. 221.*

**920—COLORINGS—Vinegar, Bottlers', Burnt Sugar, Sugar, Fruit.**

Hamilton Vinegar Works, Hamilton, Ont.

**921—COLORING—Cheese, Butter.**

Wells & Richardson Co., Montreal, Que.

**922—COLUMNS—Pump.**

McDougall, R. & Co., Galt, Ont. *Advt. page 199.*

**923—COLUMNS—Wood.**

Edwards, W. C. & Co. Ltd., Ottawa, Ont. *Advt. p. 219.*

**924—COLUMNS—Steel, Wrought Iron.**

Central Bridge & Engineering Co. Ltd., Peterboro, Ont. *Advt. page 214.*

**925—COLUMNS—(Boiler Plate), Iron Water.**

White, W. C. Boiler Works, Montreal, Que.  
Goldie & McCulloch Co. Ltd., Galt, Ont. *Advt. p. 159.*  
Carrier, Laine & Co., Levis, Que. *Advt. page 150.*  
Canada Locomotive & Engine Co. Ltd., Kingston, Ont. *Advt. page 175.*  
Dominion Bridge Co. Ltd., Montreal, Que. *Advt. 195.*  
Matheson, I. & Co., New Glasgow, N. S. *Advt. p. 200.*

**926—COLUMNS—(Cast Iron), Building, Store Front.**

Gurney, Tilden Co. Ltd., Hamilton, Ont. *Advt. p. 151.*  
Rodden, Wm. & Co., Montreal, Que.  
Valleyfield Foundry & Machine Works, Valleyfield, Que. *Advt. page 191.*  
Loignon, A. & E., Montreal, Que. *Advt. page 247.*  
Parker, Moses, Montreal, Que. *Advt. page 197.*  
Fleck, Alex. Jr., Ottawa, Ont. *Advt. page 252.*

**927—COLUMNS—Shaft.**

Garth & Co., Montreal, Que. *Advt. page 154.*

**928—COMBINATIONS—Ribbed Knitted Cotton & Wool, Ladies' and Children's.**

Turnbull, (The C.) Co., Galt, Ont. *Advt. page 203.*  
Eagle Knitting Co., Hamilton, Ont. *Advt. page 184.*

**929—COMBS—(Metal), Curry.**

Smart, (Jas.) Mfg Co., Brockville, Ont. *Advt. p. 178.*  
Purrow, Stewart & Milne, Hamilton, Ont.  
Gardner, N. R., Lyn, Ont.

**930—COMFORTERS—(Bed), Down.**

Alaska Feather & Down Co., Montreal, Que.  
Thompson, D. W. & Co., Toronto, Ont.

**931—COMMUTATORS—Electric.**

Ness, McLaren & Bate, Montreal, Que. *Advt. p. 240.*  
Canadian General Electric Co. Ltd., Toronto, Ont.

**932—COMPASSES—(Folding Sight), Surveyors', Miners'.**

Foster, James, Toronto, Ont.

**933—COMPOSITION—Roller.**

Canada Printing Ink Co., Toronto, Ont.  
Ramsay, A. & Son, Montreal, Que. *Advt. page 211.*

**934—COMPOUND—Core.**

Hamilton Facing Mill Co. Ltd., Hamilton, Ont. *Advt. page 193.*

**935—COMPOUND—Washing.**

Cottam, Barto & Co., London, Ont.  
Pure Gold Mfg Co., Toronto, Ont.

**936—COMPOUND—Boiler Cleaning.**

Young & Bro. Co. Ltd., Hamilton, Ont. *Advt. p. 257.*  
Gardner, R. & Son, Montreal, Que.

**937—COMPOUND—Insulating, (Armature), Field Coil, Weather Proof Wire.**

Farr, J. H. & Co., Toronto, Ont. *Advt. page 211.*

**938—COMPOUND—Insulatory. See No. 937.**

**939—COMPOUND—Syrup, Trifolium, Cerebral Sedative, Glycerole Yerbine.**

Parke, Davis & Co., Walkerville, Ont.

**940—COMPRESSORS—Air, Gas, Steam.**

Canadiau Rand Drill Co., Sherbrooke, Que. *Advt. page 165.*

**941—CONCENTRATIONS—Medicinal.**

Parke Davis & Co., Walkerville, Ont.  
Stearns, Fred'k & Co., Windsor, Ont. *See back cover.*

**942—CONCENTRATORS—Ore.**

Jenckes Machine Co., Sherbrooke, Que. *Advt. p. 165.*

**943—CONCENTRATORS—Gold.**

Thompson, Joseph, St. John, N. B.

**944—CONDENSERS—Ammonia, Distilling (for Ice Machines).**

Goubert Mfg Co. (The), Montreal, Que. *Advt. p. 194.*

**945—CONDENSERS & AIR PUMPS—Independent.**

Goldie & McCulloch Co. Ltd., Galt, Ont. *Advt. p. 159.*  
Carrier, Laine & Co., Levis, Que. *Advt. page 150.*  
Northey Mfg Co. Ltd., Toronto, Ont.

**946—CONDENSERS—Surface, Keel, Jet.**

Goldie & McCulloch Co. Ltd., Galt, Ont. *Advt. p. 159.*  
Waring, White & Co., St. John, N. B. *Advt. p. 256.*  
Robb Engineering Co. Ltd., Amherst, N. S. *See inside front cover.*  
Carrier, Laine & Co., Levis, Que. *Advt. page 150.*  
Goubert Mfg Co. (The), Montreal, Que. *Advt. p. 194.*

**947—CONDENSERS & AIR PUMPS—Combined.**

Laurie Engine Co., Montreal, Que. *Advt. page 179.*  
Carrier, Laine & Co., Levis, Que. *Advt. page 150.*

**948—CONDUCTORS—Roof Water.**

Metallic Roofing Co. of Canada Ltd. (The), Toronto, Ont. *See front fly leaf.*  
Smart, (Jas.) Mfg Co., Brockville, Ont. *Advt. p. 178.*  
Douglass Bros., Toronto, Ont. *Advt. page 204.*  
Garth & Co., Montreal, Que. *Advt. page 154.*

**949—CONES—Bicycle.**

Morrow Machine Screw Co. (John), Ingersoll, Ont. *Advt. page 260.*

**950—CONES—Friction, Wire Rope.**

Carrier, Laine & Co., Levis, Que. *Advt. page 150.*  
Jenckes Machine Co., Sherbrooke, Que. *Advt. p. 165.*  
Gardner, Robert & Sons, Montreal, Que.

**951—CONES—Blacksmiths'.**

Smart, (Jas.) Mfg Co. Brockville, Ont. *Advt. page 178.*  
Jardine, A. B. & Co., Hespeler, Ont. *Advt. page 217.*

**952—CONFECTIONERY SPECIALTIES—Boiled Goods, (Mixed), Candy, Chocolates, Creams, Cough Drops, Gum Goods, Lozenges, Marsh Mallow Goods, Penny Goods, Licorice, Tablets.**

McCormick Mfg Co. Ltd., London, Ont.  
Patterson, Wm. & Son, Brantford, Ont.  
Crothers, W. G., Kingston, Ont.  
Moir Son & Co., Halifax, N. S.

- Viau & Bros., Montreal, Que.  
 White, Cowell & Co., St. John, N. B.  
 Ganong Bros. Ltd., St. Stephen, N. B.  
 Godin, G. N. & Co., Three Rivers, Que.  
 Winfield, R., Quebec, Que.  
 Dupuis, A. B., Quebec, Que.  
 Robertson Bros., Toronto, Ont.  
 Watson, R. & T., Toronto, Ont.  
 Lang Mfg Co., Montreal, Que.  
 Tester & Co., Montreal, Que.  
 Toronto Biscuit & Conf. Co., Toronto, Ont.  
 Hamilton, G. J. & Son., Pictou, N. S.  
 Hamilton Biscuit & Conf. Co., Hamilton, Ont.  
 Halifax Conf. & Baking Co. Ltd., Halifax, N. S.
- 953—CONNECTIONS—Pump.**  
 McDougall, R. & Co., Galt, Ont. *Advt. page 199.*
- 954—CONVERTERS—Electric.**  
 Ahearn & Soper, Ottawa, Ont.
- 955—CONVEYERS & EXTRACTORS—Saw Dust.**  
 Brush, Geo., Montreal, Que.
- 956—CONVEYERS—Steel Spiral.**  
 Goldie & McCulloch Co. Ltd., Galt, Ont. *Advt. 159.*  
 Miller Bros. & Toms, Montreal, Que. *Advt. p. 197.*  
 Kerr & Morgan, Montreal, Que. *Advt. page 220.*
- 957—COOKERS—Steam.**  
 Garth & Co., Montreal, Que. *Advt. page 154.*
- 958—COOLERS—Milk.**  
 Lancaster Machine Works, Lancaster, Ont. *Advt. page 248.*  
 Pontbriand & Bros., Sorel, Que.  
 Chown, W. W. & Co., Belleville, Ont. *Advt. p. 233.*
- 959—COOLERS—Candy.** *See No. 3079.*
- 960—COOLERS—Potash.**  
 Gurney, Tilden & Co. Ltd., Hamilton, Ont. *Advt. 151.*
- 961—COOLERS—Water.**  
 Davidson Mfg Co. Ltd. (The Thos.), Montreal, Que. *Advt. page 225.*  
 Piper, Noah L. & Son, Toronto, Ont.
- 962—COOPS—Wire Poultry.**  
 Dennis Wire & Iron Works, London, Ont. *Advt. 207.*
- 963—COPING—Iron,**  
 Dominion Ornamental Iron Co., Montreal, Que.
- 964—COPING—Stone.**  
 Canadian Granite Co. Ltd., Ottawa, Ont.
- 965—COPING—Wall.**  
 Standard Drain Pipe Co. Ltd., St. Johns, Que. *Advt. page 251.*
- 966—COPING—Metal.**  
 Metallic Roofing Co. of Canada Ltd. (The), Toronto, Ont. *See front fly leaf.*  
 Douglass Bros., Toronto, Ont. *Advt. page 204.*
- 967—COPING—Terra Cotta.**  
 Rathbun Co. (The), Deseronto, Ont. *Advt. page 162.*  
 Beamsville Pressed Brick Co., Beamsville, Ont. *Advt. page 215.*
- 968—COPPER—Sheet.**  
 Kemp Mfg Co., Toronto, Ont.  
 Chadwick Bros., Hamilton, Ont. *Advt. page 206.*

**969—COPPERAS.**

Canada Chemical Mfg Co. Ltd., London, Ont.

**970—COPPER—Dynamo Brush.**

Forrester, Thos., Montreal, Que. *See front fly leaf.*

**971—COPPERS—Soldering.**

Brown, Boggs & Co., Hamilton, Ont. *Advt. p. 193.*  
 Davidson Mfg Co. Ltd. (The Thos.), Montreal, Que. *Advt. page 225.*

Coulter & Campbell, Toronto, Ont. *Advt. page 201.*  
 McAvity, T. & Sons, St. John, N. B. *Advt. page 153.*

**972—COPPER WORKS.**

American Copper Co., Toronto, Ont. *Advt. page 157.*  
 Booth Copper Co., Toronto, Ont. *Advt. page 155.*  
 Coulter & Campbell, Toronto, Ont. *Advt. page 201.*  
 Parker, J. O. & Co., Toronto, Ont. *Advt. page 253.*  
 Chadwick Bros., Hamilton, Ont. *Advt. page 206.*  
 Garth & Co., Montreal, Que. *Advt. page 154.*  
 Mitchell, Robert & Co., Montreal, Que. *Advt. p. 213.*

**973—CORD—Leather Bell.**

Robin, Sadler & Haworth, Montreal, Que. *Advt. 226.*

**974—CORD—Tarred.**

Dovercourt Twine Mills Co., Toronto, Ont. *Advt. 184.*  
 Perine, M. B. & Co., Doon, Ont. *Advt. page 181.*  
 Consumers Cordage Co., Montreal, Que.  
 Kingston Cordage Co., Kingston, Ont.

**975—CORD—Bell, Sash, Jute, Shade, Picture, Curtains.**

Canada Jute Co., Montreal, Que. *Advt. page 225.*  
 Dovercourt Twine Mills Co., Toronto, Ont. *Advt. 184.*  
 Perine, M. B. & Co., Doon, Ont. *Advt. page 181.*

**976—CORD—(Wire), Flexible & Telephone.**

Canadian General Electric Co. Ltd., Toronto, Ont.  
 Phillips Electrical Works Ltd., Montreal, Que.

**977—CORDS—(Wire), Sash.**

Greening Wire Co. Ltd. (The B.), Hamilton, Ont.

**978—CORDS—Silk, Cotton, Mohair, Hat.**

Moulton & Co., Montreal, Que.

**979—CORDAGE—Wire.**

Dominion Wire Rope Co. Ltd., Montreal, Que. *Advt. page 171.*

**980—CORDAGE—Manilla & Sisal.**

Consumer Cordage Co., Montreal, Que.  
 Main, Alex. & Son, Hamilton, Ont.

**981—CORDIAL—Fluid Beef.**

Johnston Fluid Beef Co., Montreal, Que.

**982—CORDIALS—Coca, Kola.**

Parke, Davis & Co., Walkerville, Ont.

**983—CORDIALS—Stearn's Kola.**

Stearns, Fred'k & Co., Windsor, Ont. *See back cover.*

**984—CORERS—Apple.**

Davidson Mfg Co. Ltd. (The Thos.), Montreal, Que. *Advt. page 225.*

**985—CORES—Armature & Magnet.**

Canadian General Electric Co. Ltd., Toronto, Ont.

**986—CORKSCREWS.**

Ives, H. R. & Co. Ltd., Montreal, Que. *Advt. p. 200.*

**987—CORKS—Bottle, Lettered.**

Canada Cork Cutting Co., Montreal, Que. *Advt. 233.*  
Cork Co. of Canada, Toronto, Ont. *Advt. page 187.*  
Doyle, J. E. & Co., Montreal, Que. *Advt. page 235.*  
Freyseng, P. & Co., Toronto, Ont. *Advt. page 235.*

**988—CORN—Pop.**

Sommerville, C. R., London, Ont. *Advt. page 235.*  
Bradshaw, W. A. & Co., Toronto, Ont.

**989—Cornices—Wood, Window.**

Edwards, W. C. & Co. Ltd., Ottawa, Ont. *Advt. 219.*  
Gignac, O. & Sons, Quebec, Que.  
Rathbun Co. (The), Deseronto, Ont. *Advt. page 162.*

**990—CORNICES—Iron.**

Rodden, Wm. & Co., Montreal, Que.  
Dennis Wire & Iron Works, London, Ont. *Advt. 207.*  
Loignon, A. & E., Montreal, Que. *Advt. page 247.*

**991—CORNICES—Terra Cotta.**

Beamsville Pressed Brick Co., Beamsville, Ont.  
*Advt. page 215.*

**992—CORNICES—Metal, (Window).**

Reed, Geo. W., Montreal, Que. *Advt. page 237.*  
Douglas Bros., Toronto, Ont. *Advt. page 204.*

**993—CORSETS—Abdominal, Nursing.**

Corset Co. (The E. T.), St. Hyacinthe, Que.  
Canada Featherbone Co., London, Ont.  
Wilmot Corset Co., South Farmington, N. S.

**994—COSMETICS—Vaseline.**

Cheseborough Mfg Co., Montreal, Que. *Advt. p. 259.*

**995—COTS—Canvas, Ambulance.**

Montreal Tent, Awning & Tarpaulin Co., Montreal,  
Que. *Advt. page 232.*  
Soper, R., Hamilton, Ont., *Advt. page 229.*  
Sonne, Thomas, Montreal, Que.

**996—COTS—(Iron), Folding, Jail, Hospital.**

Ives, H. R. & Co., Montreal, Que. *Advt. page 200.*  
Munro Bros., New Glasgow, N. S. *Advt. page 244.*  
Young & Bro. Co. Ltd., Hamilton, Ont. *Advt. p. 257.*

**997—COTS—Folding Camp.**

Soper, R., Hamilton, Ont. *Advt. page 229.*

**998—COTS—Finger.**

Alpha Rubber Co. Ltd., Montreal, Que.

**999—COTS—(Wire), Folding.**

Meadows, George B., Toronto, Ont.  
Gold Medal Bed Spring Co., Toronto, Ont.  
Knowles, Ham & Nott Co. Ltd., Brantford, Ont.  
*Advt. page 220.*

**1000—COTS—Bamboo, Reed.**

Gendron Mfg Co. Ltd., Toronto, Ont. *Advt. page 187.*  
Thompson, Alex. & Co. Hamilton, Ont.

**1001—COTTERS—Spring.**

Whitman & Barnes Mfg Co., St. Catharines, Ont.

**1002—COTTOLENE—(Compound Lard.**

Fairbank Co. (The N. K.), Montreal, Que.

**1003—COTTONS—(Knitting), Colored, Grey.**

Parks, Wm. & Son Ltd., St. John, N. B. *Advt. p. 233.*  
Canadian Colored Cotton Mills Co. (The), Montreal,  
Que. *Advt. page 181.*

Dominion Cotton Mills Co. (The), Montreal, Que.  
*Advt. page 181.*

Hamilton Cotton Co., Hamilton, Ont. *Advt. page 188.*

**1004—COTTON—Spool.**

Canada Thread Co., Montreal, Que.

**1005—COUPLINGS—Shaft, Pole, Sleigh.**

Carrier, Laine & Co., Levis, Que. *Advt. page 150.*  
Gillies, (Geo.), Co., Gananoque, Ont. *Advt. p. 156.*

**1006—COUPLINGS—Carriage.**

Swansea Forging Co. Ltd. (The), Swansea, Ont.  
*Advt. page 156.*

**1007—COUPLINGS—Bell Cord, Malleable.**

Frost, W. H., Smiths Falls, Ont.  
Kyle, P., Merrickville, Ont.

**1008—COUPLINGS—Pipe.**

Montreal Rolling Mills Co. Ltd., Montreal, Que.  
*Advt. page 174.*  
Garth & Co., Montreal, Que. *Advt. page 154.*

**1009—COUPLINGS—Pump Rod.**

McAvity, T. & Sons, St. John, N. B. *Advt. page 153.*  
McDougall, R. & Co., Galt, Ont. *Advt. page 199.*  
Malleable Iron Co., Montreal, Que.

**1010—COUPLINGS—Belt.**

Parmenter & Bulloch, Gananoque, Ont. *Advt. p. 199.*

**1011—COUPLINGS—Flanged, Face.**

Wilson, J. C. & Co., Glenora, Ont.

**1012—COUPLINGS—Hose.**

Carrier, Laine & Co., Levis, Que. *Advt. page 150.*  
McAvity, T. & Sons, St. John, N. B. *Advt. page 153.*  
Macdonald & Co. Ltd., Halifax, N. S. *Advt. page 256.*  
Parker, J. O. & Co., Toronto, Ont. *Advt. page 253.*  
Smart, (Jas.) Mfg Co., Brockville, Ont. *Advt. p. 178.*  
Garth & Co., Montreal, Que. *Advt. page 154.*  
Mitchell, Rob't & Co., Montreal, Que. *Advt. p. 213.*

**1013—COUPLINGS—Clutch, Cut-Off, Friction, Friction Clutch Cut-Off, Universal Joint.**

Garth & Co., Montreal, Que. *Advt. page 154.*  
Macdonald & Co. Ltd., Halifax, N. S. *Advt. p. 256.*  
Young Bro., Almonte, Ont. *Advt. page 250.*  
Matheson, I. & Co., New Glasgow, N. S. *Advt. p. 200.*  
Goldie & McCulloch Co. Ltd., Galt, Ont. *Advt. p. 159.*  
Fleck, Alex. Jr., Ottawa, Ont. *Advt. page 252.*  
Carrier, Laine & Co., Levis, Que. *Advt. page 150.*  
Jenckes Machine Co., Sherbrooke, Que. *Advt. p. 165.*  
Robb Engineering Co. Ltd., Amherst, N. S.

*See front cover.*

Mac. Machine Co., Belleville, Ont. *Advt. page 194.*  
Brown, (G. & J.) Mfg Co., Belleville, Ont. *Advt. p. 198.*  
Gardner, Rob't & Son, Montreal, Que.

**1014—COUCHES—Rattan.**

Gendron Mfg Co. Ltd., Toronto, Ont. *Advt. page 187.*

**1015—COUNTERPANES & BED SPREADS.**

Camelford, John Jr., & Co., Paris, Ont.

**1016—COUNTERS—Revolution, Speed.**

Morrison, Jas. Brass Mfg Co., Toronto, Ont. *Advt. 157.*

**1017—COUNTERS—Boot & Shoe.**

Dominion Leather Board Co., Montreal, Que.



Richard & Co., Montreal, Que.  
Rochette, C., Quebec, Que.  
Duclos & Pavan, St. Hyacinthe, Que.  
White, R. & Co., Montreal, Que.

**1 018—COUNTERS—(Wood), Bank, Office, Store.**

Canadian Office & School Furniture Co. Ltd. (The), Preston, Ont. *Advt. page 210.*  
Globe Furniture Co. Ltd., Walkerville, Ont. *Advt. 225.*  
Rhodes, Curry & Co. Ltd., Amherst, N. S. *Advt. 158.*  
Edwards, W. C. & Co. Ltd., Ottawa, Ont. *Advt. 219.*  
Rathbun Co. (The), Deseronto, Ont. *Advt. page 162.*

**1 019—COUNTERSHAFTS.**

Hart Emery Wheel, Hamilton, Ont. *Advt. page 166.*

**1 020—COUNTERSINKS.**

Butterfield & Co., Rock Island, Que.

**1 021—COVERINGS—Asbestos.**

Gardner, Robert & Son, Montreal, Que  
Sclater Asbestos Mfg Co., Montreal, Que. *Advt. p. 172.*  
Forrester, Thos., Montreal, Que. *See front fly leaf.*  
Clappison Pipe & Boiler Covering Co. Hamilton, Ont. *Advt. page 193.*  
Hamilton Engine Packing Co. (The), Hamilton, Ont. *Advt. page 193.*

**1 022—COVERING—Furniture, (Hair Cloth).**

Canada Hair Cloth Co., St. Catharines, Ont.

**1 023—COVERING—Boiler & Pipe, Forrester's Patent.**

Forrester Thos., Montreal, Que. *Front Fly Leaf.*

**1 024—COVERINGS—(Asbestos), Sectional Boiler.**

Sclater Asbestos Mfg Co., Montreal, Que., p. 172.

**1 025—COVERINGS—Boiler & team Pipe, Magnesia Sectional.**

Sclater Wm. & Co., Montreal, Que., *Advt. page 172.*  
Clappison Pipe & Boiler Covering Co., Hamilton, *Advt. page 193.*  
Hamilton Engine Packing Co., (The), Hamilton, Ont. *Advt. page 193.*

**1 026—COVERINGS—Pipe, (Hair Felt).**

Berlin Felt Boot Co., (The), Berlin, Ont.

**1 027—COVERS—(Iron)—Coal Hole, Manhole.**

Carrier, Laine & Co., Levis, Que. *Advt. page 150.*  
Garth & Co., Montreal, Que. *Advt. page 154.*

**1 028—COVERS—Cylinder, (Cast).**

Matheson I. & Co., New Glasgow, N.S. *Advt. p. 200.*  
Jenckes Machine Co., Sherbrooke, Que. *Advt. p. 165.*  
Carrier, Laine & Co., Levis, Que. *Advt. page 150.*

**1 029—COVERS—Grave,**

Dennis, London, Ont. *Advt. page 207.*

**1 030—COVERS—Kettle Iron.**

Carrier, Laine & Co., Levis, Que. *Advt. page 150.*

**1 031—COVERS—Cesspool, Gutter.**

Ives, H. R. & Co., Montreal, Que. *Advt. page 200.*  
Tisdale Iron Stable Fitting Co. Ltd. (The), Toronto, Ont. *Advt. page 202.*

**1 032—COVERS—Barrel, (Wood).**

Eddy Co. Ltd. (The E. B.), Hull, Que.

**1 033—COVERS—Wire Barrel.**

Davidson Mfg Co. Thos., Montreal, Que. *Advt. p. 225.*  
Dennis, London, Ont. *Advt. page 207.*  
Munro Bros., New Glasgow, N. S. *Advt. page 244.*  
Meadows, George B., Toronto, Ont.

**1 034—COVERS—Adjustable Book.**

Gage Co., Ltd., (W. J.), Toronto, Ont. *Advt. p. 189.*

**1 035—COVERS—Fishing Rod, Gun, Trunk,**

O'Shaughnessy R. & Co., St. John, N.B.  
Borbridge S. & H., Ottawa, Ont.,

**1 036—COVERS—(Canvass), Sail, Boat, Hay & Grain Stack.**

Pike D., Toronto, Ont. *Advt. page 182.*  
Soper R., Hamilton, Ont. *Advt. page 229.*

**1 037—COVERS—(Rubber), Piano & Organ, Salvage, Horse, Wapon. See No. 277.**

**1 038—COVERS—(Oil Duck), Horse, Wagon, Salvage. See No. 3433.**

**1 039—CRABS—Horse Power.**

Kerr & Morgan, Montreal, Que. *Advt. page 220.*  
Miller Bros. & Toms, Montreal, Que. *Advt. page 197.*  
Matheson I. & Co., New Glasgow, N.S. *Advt. p. 200.*  
Robb Engineering Co. Ltd., Amherst, N.S.  
*Inside front cover.*

**1 040—CRACKERS—Butter, Oyster. See No. 263.**

**1 041—CRADLES—Wicker, (Childs).**

Pelosse P., Montreal, Que. *Advt. page 234.*

**1 042—CRADLES—Grain. See Scythe No. 2950.**

**1 043—CRADLES & CRIBS—(Reed & Rattan).**

Gendron Mfg Co. Ltd., Toronto, Ont. *Advt. page 187.*  
Windsor Furniture Co., Windsor, N. S.  
American Rattan Co., Toronto, Ont.

**1 044—CRANES—Locomotive.**

Canadian Locomotive & Engine Co. Ltd., Kingston, Ont. *Advt. page 175.*

**1 045—CRANES—Cheese Factory.**

Carrier, Laine & Co., Levis, Que. *Advt. page 150.*  
Sleepers & Akhurst, Coaticooke, Que. *Advt. p. 241.*  
Brown, (G. & J.) Mfg Co. Ltd., Belleville, Ont.  
*Advt. page 198.*

Lancaster Machine Works, Lancaster, Ont. *page 248.*  
Richardson & Webster, St. Mary's, Ont.

**1 046—CRANES—Swing, Hydraulic, Jib, Ladle, Hand, Derrick, Bridge, Gantry, Power, Rotary, Tram, Traveling.**

Beatty M. & Sons, Welland, Ont. *Advt. page 173.*  
Ingersoll Rock Drill Co., Montreal, Que. *Advt. p. 198.*  
Jenckes Machine Co., Sherbrooke, Que. *Advt. p. 165.*  
Kerr & Morgan, Montreal, Que. *Advt. page 220.*  
Carrier, Laine & Co., Levis, Que. *Advt. page 150.*  
Miller Bros. & Toms, Montreal, Que. *Advt. page 197.*  
Brown, (G. & J.) Mfg Co. Ltd., Belleville, Ont.  
*Advt. page 198.*

Loignon A. & E., Montreal, Que. *Advt. page 247.*

**1 047—CRANKS—Heavy Wagon.**

Stewart John, New Glasgow, N.S. *Advt. page 222.*

**1048—CRANKS—Bell.**

Young & Bros. Co. Ltd., (The), Hamilton, Ont.  
*Advt. page 257.*

**1049—CRATES—Berry.** *See Baskets No .160.***1050—CRATES—Vegetable, Banana, Onion.**

Galey John & Co., St. John, N.B.  
Flewelling Mfg Co., (G. & G.), Hampton, N.B.  
Watson's Box Factory, London, Ont.  
Cushins, Andre & Co., St. John, N.B.

**1051—CRATES—Bee Shipping.**

Goold, Shapley & Muir Co., Brantford, Ont. *p. 191.*  
Russell W. G., Millbrook, Ont.

**1052—CREAM—Evaporated.**

Truro Condensed Milk Co. Ltd., Truro, N.S.

**1053—CREASERS—Adze Eye, (Blacksmiths')**

Whitman & Barnes Mfg. Co., St. Catharines, Ont.

**1054—CREEPERS—Ice.**

Parmenter & Bulloch, Gananoque, Ont. *Advt. p. 199.*

**1055—CREOSOTE.**

Lyman, Sons & Co., Montreal, Que.

**1056—CRESTINGS—Terra Cotta.**

Beamsville Pressed Brick Co., Beamsville, Ont. *p. 215.*

**1057—CRESTINGS—Iron Roof.**

Ives H. R. & Co., Montreal, Que. *Advt. page 200.*  
Garth & Co., Montreal, Que. *Advt. page 154.*  
Carrier, Laine & Co., Levis, Que. *Advt. page 150.*  
Smart, James Mfg. Co., Brockville, Ont. *Advt. p. 178.*  
Rodden Wm. & Co., Montreal, Que.  
Toronto Fence & Ornament Iron Works, Toronto, Ont.  
Dennis Wire & Iron Works, London, Ont. *Advt. 207*  
Dominion Ornamental Iron Co., Montreal, Que.  
Brown, (G. & J.) Mfg Co., Belleville, Ont. *Advt. 198.*

**1058—CRIBS—Folding Wire Mattress.**

Knowles, Ham & Nott Co, Ltd., Brantford, Ont.  
*Advt. page 220.*

**1059—CRIBS—Wire, Iron.**

Ives H. R. & Co., Montreal, Que. *Advt. page 200.*

**1060—CRIMPERS—Blind Slat.**

Goldie & McCulloch Co. Ltd., Galt, Ont. *Advt. p. 159.*  
MacGregor, Gourlay & Co., Galt, Ont.

**1061—CRIMPERS—Boot & Shoe.**

Lendon William H., Toronto, Ont.  
Chalifoux O., Quebec, Que. *Advt. page 232.*  
Lewis J. & Son, Truro, N. S.

**1062—CRIMPERS—Metal Power.**

Brown, Boggs & Co., Hamilton, Ont. *Advt. p. 193.*

**1063—CROSS ARMS—Telegraph.**

Flewelling Mfg Co. (The G. & G.), Hampton, N.B.  
Rathbun Co., (The), Deseronto, Ont. *Advt. p. 162.*  
Rhodes, Curry & Co., Amherst, N.S. *Advt. p. 158.*  
Edwards W. C. & Co. Ltd., Ottawa, Ont. *Advt. p. 219.*  
Pembroke Lumber Co., Pembroke, Ont. *Advt. p. 216.*  
Firstbrook Bros., Toronto, Ont.

**1064—CROCKS—Butter, Milk.**

Brantford Stoneware Mfg Co. Ltd. (The), Brantford, Ont. *Advt. page 251.*

**1065—CROSSINGS—Diamond, Railway.**

Brown, (G. & J.), Mfg Co., Belleville, Ont. *Advt. 198.*  
Canada Spring Switch Co. Ltd., Montreal, Que.  
*Advt. page 217.*

**1066—CROWS—Jim.**

Brown, (The G. & G.), Mfg Co. Ltd., Belleville, Ont.  
*Advt. page 198.*

**1067—CRUPPERS—Harness.**

Borbidge S. & H., Ottawa, Ont.

**1068—CRUSHERS—"Blake."**

Brown, (G. & J.), Mfg Co., Belleville, Ont. *Advt. 198.*

**1069—CRUSHERS—Corn, Cob, Barley.**

Goldie & McCulloch Co. Ltd., Galt, Ont. *Advt. p. 159.*

**1070—CRUSHERS—"Gate", "Jaw".**

Ingersoll Rock Drill Co., Montreal, Que. *Advt. p. 198.*

**1071—CRUSHERS & MIXERS—Clay.**

Goldie McCulloch Co. Ltd. Galt, Ont. *Advt. page 159.*

**1072—CRUSHERS—Plaster.**

Brush, John, Montreal, Que.

**1073—CRUSHERS—Beef Steak.**

Creelman Bros., Georgetown, Ont.

**1074—CRUSHERS—Grain.**

Carrier, Laine & Co., Levis, Que. *Advt. page 150.*  
Hamilton Mfg Co. (Peter), Peterboro, Ont. *Advt. 209.*  
Waterloo Mfg Co. Ltd., Waterloo, Ont. *Advt. p. 218.*  
Paxton, Tate & Co., Port Perry, Ont.  
Coleman, T. T. (Estate of), Seaforth, Ont.

**1075—CRUSHERS—Ore.**

Matheson, I. & Co., New Glasgow, N.S. *Advt. p. 200.*  
Jenckes Machine Co., Sherbrooke, Que. *Advt. p. 165.*  
Fraser Bros., New Glasgow, N. S. *Advt. page 252.*  
Brown, (G. & J.), Mfg Co., Belleville, Ont. *Advt. 198.*  
Truro Foundry & Machine Co., Truro, N. S. *Advt. 198.*  
Ingersoll Rock Drill Co., Montreal, Que. *Advt. 198.*  
Brush, Geo., Montreal, Que.

**1076—CRUSHERS—Rock & Stone, Portable.**

Kerr & Morgan, Montreal, Que. *Advt. page 220.*  
Jenckes Machine Co., Sherbrooke, Que. *Advt. p. 165.*  
Miller Bros. & Toms, Montreal, Que. *Advt. page 197.*  
Brown, (G. & J.), Mfg Co., Belleville, Ont. *Advt. 198.*  
Brush, Geo., Montreal, Que.

**1077—CRUTCHES.**

Carlisle, J. & Co., Montreal, Que.  
Gross, F., Montreal, Que.  
Authors & Cox, Toronto, Ont.

**1078—CRYSTAL—Washing.**

Gillett, E. E., Toronto, Ont.

**1079—CRYSTAL—SODA.**

Victoria Chemical Co. Ltd. (The), Victoria, B. C.

**1080—CUES & TIPS—Billiard.**

Reid Bros. Mfg Co. (The), Toronto, Ont.  
May, Samuel & Co., Toronto, Ont.  
Ethier E. L. & Co., Montreal, Que.  
Nightingale D., Montreal, Que.

**1081—CULTIVATORS—Spring Tooth.**

Hamilton Mfg Co. (Peter), Peterboro, Ont. *Advt. 209.*  
Noxon Bros. Mfg. Co., Ingersoll, Ont.

**1082—CULTIVATORS & SEEDERS—Combined.**

Noxon Bros. Mfg. Co., Ingersoll, Ont.

**1083—CULTIVATORS—Corn, Root, Horse.**

Chalifoux, O. & Sons, St. Hyacinthe, Que. *Advt. 232.*  
Moody, Matthew & Sons, Terrebonne, Que. *Advt. 209.*  
Hamilton Mfg. Co. (Peter), Peterboro, Ont. *Advt. 209.*  
Bell, B. & Son, St. George, Ont.  
Gowdy Mfg Co., Guelph, Ont.  
Grout, John H. & Co., Grimsby, Ont.  
Waterloo Mfg Co. Ltd. Waterloo, Ont. *Advt. page 218.*

**1084—CUPS—Dentists' Spit (Nickle & Brass).**

American Copper Co., Toronto, Ont. *Advt. page 157.*  
Booth Copper Co., Toronto, Ont. *Advt. page 155.*  
Chadwick Bros., Hamilton, Ont. *Advt. page 206.*  
Garth & Co., Montreal, Que. *Advt. page 154.*  
Hamilton Brass Mfg Co., Hamilton, Ont. *Advt. p. 168.*  
Mitchell, Robert & Co., Montreal, Que. *Advt. p. 213.*  
Parker, J. O. & Co., Toronto, Ont. *Advt. page 253.*

**1085—CUPS—(Greese), Engine, Crank Pin.**

American Copper Co., Toronto, Ont. *Advt. page 157.*  
Booth Copper Co., Toronto, Ont. *Advt. page 155.*  
Coulter & Campbell, Toronto, Ont. *Advt. page 201.*  
Garth & Co., Montreal, Que. *Advt. page 154.*  
Hamilton Brass Mfg Co., Hamilton, Ont. *Advt. 168.*  
Lancaster Machine Works, Lancaster, Ont. *Advt. 248.*  
Robb Engineering Co. Ltd., Amherst, N. S.

*See inside front cover.*  
Macdonald & Co. Ltd., Halifax, N. S. *Advt. p. 256.*  
Penberthy Injector Co., Windsor, Ont. *Advt. p. 164.*  
Morrison, (Jas.) Brass Mfg Co., Hamilton, Ont.

*Advt. page 157.*  
McAvity, T. & Sons, St. John, N. B. *Advt. page 153.*  
Parker, J. O. & Co. Toronto, Ont. *Advt. page 253.*  
Mitchell, Robert & Co., Montreal, Que. *Advt. p. 213.*

**1086—CUPS & SAUCERS—Plated.**

Simpson, Hall, Miller & Co., Montreal. *Advt. 203.*

**1087—CUPS—Communion.**

Chadwick Bros., Hamilton, Ont. *Advt. page 206.*

**1088—CUPS—Cupping.**

Alpha Rubber Co. Ltd., Montreal, Que.

**1089—CUPS—Automatic Rod, Drinking Fountain, Eccentric, Slide Top.**

Morrison, Jas. Brass Mfg Co., Toronto, Ont. *Advt. 157.*

**1090—CUPS—Tin.**

Davidson Mfg Co. Ltd. (Thomas), Montreal, Que. *Advt. page 225.*  
Chown, W. W. & Co., Belleville, Ont. *Advt. p. 233.*  
Macdonald Mfg Co., Toronto, Ont.

**1091—CUPS—Rubber Force.**

Gutta Percha & Rubber Mfg Co. Ltd., Toronto, Ont. *See back cover.*  
Canadian Rubber Co., Montreal, Que. *Advt. page 197.*  
Toronto Rubber Co. Ltd. (The), Toronto, Ont.

**1092—CUPS—Elevator.**

Kerr & Morgan, Montreal, Que. *Advt. page 220.*  
Goldie & McCulloch Co. Ltd. (The), Galt, Ont. *Advt. page 159.*  
Miller Bros. & Toms, Montreal, Que. *Advt. page 197.*

**1093—CUPS—Glass & Metal Oil.**

Garth & Co., Montreal, Que. *Advt. page 154.*

Mitchell, Robert & Co., Montreal, Que. *Advt. p. 213.*  
Morrison (James) Brass Mfg Co., Toronto, Ont.

*Advt. page 157.*  
Hamilton Brass Mfg Co., Hamilton, Ont. *Advt. 168.*  
Robb Engineering Co. Ltd., Amherst, N.S.

*Inside front cover.*  
McAvity, T. & Sons, St. John, N.B. *Advt. page 153.*  
Macdonald & Co. Ltd., Halifax, N.S. *Advt. page 256.*

**1094—CURCUMA.**

Brayley, Sons & Co., Montreal, Que.  
Young & Son, Montreal, Que.

**1095—CURLERS—Steel Hair.**

St. Lawrence Steel & Wire Co., Ltd., Gananoque, Ont. *Advt. page 183.*  
Robertson, E. & Co., Hamilton, Ont.

**1096—CURLER—Liquid Hair.**

Dorenwend Co. Ltd. (The), Toronto, Ont.

**1097—CURTAINS—(Chenille), Drapery, Tapestry.**

Toronto Carpet Mfg Co. Ltd., Toronto, Ont. *Advt. 186.*  
Curtain & Upholstering Mfg Co. Ltd., Guelph, Ont.

**1098—CURTAINS—Rubber Bath.**

Toronto Rubber Co. Ltd. (The), Toronto, Ont.

**1099—CUSHIONS—Billiard Table, (Rubber).**

Canadian Rubber Co., Montreal, Que. *Advt. page 197.*  
Toronto Rubber Co. Ltd. (The), Toronto, Ont.  
Reid Bros. Mfg Co., Toronto, Ont.  
May, Sam'l & Co., Toronto, Ont.

**1100—CUSHIONS—Carriage & Waggon Vehicle.**

Dowell, Dan'l, Montreal, Que. *Advt. page 203.*  
Guelph Carriage Top Co., Guelph, Ont.

**1101—CUSHIONS—Fancy, Down.**

Alaska Feather & Down Co., Montreal, Que.

**1102—CUSHIONS—Rubber Air.**

Alpha Rubber Co. Ltd., Montreal, Que.

**1103—CUSHIONS—Cork Canoe.**

Soper, R., Hamilton, Ont. *Advt. page 229.*

**1104—CUSHIONS—Pneumatic (Rubber) Chair**

Canadian Rubber Co., Montreal, Que. *Advt. page 197.*

**1105—CUSHIONS—(Spiral Spring), Railway Car, Buggy.**

Munro Bros., New Glasgow, N.S. *Advt. page 244.*

**1106—CUSHIONS—Church.**

Globe Furniture Co. Ltd., Walkerville, Ont. *Advt. 225.*  
Canadian Office & School Furniture Co. Ltd. (The), Preston, Ont. *Advt. page 210.*

**1107—CUSPADORES—Brass, Nickle, Copper, Self-Righting.**

Coulter & Campbell, Toronto, Ont. *Advt. page 201.*  
Hamilton Brass Mfg Co., Hamilton, Ont. *Advt. 168.*  
Chadwick Bros., Hamilton, Ont. *Advt. page 206.*  
Parker, J. O. & Co., Toronto, Ont. *Advt. page 253.*  
Garth & Co., Montreal, Que. *Advt. page 154.*  
American Copper Co., Toronto, Ont. *Advt. page 157.*  
Booth Copper Co., Toronto, Ont. *Advt. page 155.*

**1108—CUSPADORES—Tin.**

Davidson Mfg Co. (Thomas), Montreal. *Advt. p.* 225.  
Chown, W. W. & Co., Belleville, Ont. *Advt. page* 233.

**1109—CUSPADORES—Iron.**

Ives, H. R. & Co., Montreal, Que. *Advt. page* 200.  
Carrier, Laine & Co., Levis, Que. *Advt. page* 150.

**1110—CUTTERS—Axle.**

Jardine, A. B. & Co., Hespeler, Ont. *Advt. page* 217.  
Butterfield & Co., Rock Island, Que.

**1111—CUTTERS—Automatic Rack, Epicycloidal.**

Bertram, John & Sons, Dundas, Ont. *Advt. p.* 161.

**1112—CUTTERS—Vehicle. See No. 3679 (Wagons).****1113—CUTTERS—Bolt.**

Bertram, John & Sons, Dundas, Ont. *Advt. p.* 161.  
Jardine, A. B. & Co., Hespeler, Ont. *Advt. p.* 217.

**1114—CUTTERS—Wire.**

Dominion Wire Mfg Co., Montreal, Que. *Advt.* 176.

**1115—CUTTERS—Weed. See Scythes No. 2950.****1116—CUTTERS—Vegetable.**

Bell, B. & Son, St. George, Ont.  
Coleman, T. T. (Estate of), Seaforth, Ont.

**1117—CUTTERS—Twine, (Mower & Reaper).**

Whitman & Barnes Mfg Co. Ltd., St. Catharines, Ont.

**1118—CUTTERS—Tobacco.**

Woodyatt, A. R. & Co., Guelph, Ont. *Advt. p.* 207.  
Ives, H. R. & Co., Montreal, Que. *Advt. page* 200.  
Smart, (Jas.) Mfg Co., Brockville, Ont. *Advt. p.* 178.

**1111—CUTTERS—Sole Leather.**

Hocking, Thomas, Montreal, Que.

**1120—CUTTERS—Stave.**

Goldie & McCulloch Co. Ltd., Galt, Ont. *Advt. p.* 159.

**1121—CUTTERS—Meat, Sausage Meat.**

Smart, (Jas.) Mfg Co., Brockville, Ont. *Advt. p.* 178.  
Ives, H. R. & Co., Montreal, Que. *Advt. page* 200.

**1122—CUTTERS—Rule & Lead, Paper.**

Vivian, John H., Toronto, Ont.  
Westman & Baker, Toronto, Ont.

**1123—CUTTERS—Pipe.**

Bessette, J. & S., Iberville, Que.

**1124—CUTTERS—Peg, (Boot & Shoe).**

*See No.* 2119.

**1125—CUTTERS—Milling.**

Whitman & Barnes Mfg Co., St. Catharines, Ont.  
Butterfield & Co., Rock Island, Que.

**1126—CUTTERS—Lever Feed.**

Waterloo Mfg Co. Ltd., Waterloo, Ont. *Advt. p.* 218.

**1127—CUTTERS—Hand Pipe, Saw Gummer.**

Butterfield & Co., Rock Island, Que.

**1128—CUTTERS—Chaff, Corn Stalk, Ensilage, Hay & Straw.**

Bell, B. & Son, St. George, Ont.

Hamilton Mfg Co. (Peter), Peterboro, Ont. *Advt.* 209.  
Moody, Matthew & Sons, Terrebonne, Que *Advt.* 209.  
Sleeper & Akhurst, Coaticook, Que. *Advt. page* 241.  
Joliette Foundry Co., Joliette, Que.  
Waterloo Mfg Co. Ltd., Waterloo, Ont. *Advt. page* 218.  
Richardson & Webster, St. Mary's, Ont.  
Wilkinson Plow Co. Ltd., Toronto, Ont.  
Drummondville Foundry Co. Drummondville, Que.  
Bessette, J. & S., Iberville, Que.

**1129—CUTTERS—Boiler Tube Scale.**

Gardner, R. & Son, Montreal, Que.

**1130—CUTTERS—Soldier.**

Brown, Boggs & Co., Hamilton, Ont. *Advt. p.* 193.

**1131—CUTS—Wood, Printers'.**

Kramer, W. J., Toronto, Ont., *Advt. page* 214.  
Toronto Engraving Co., Toronto, Ont.  
Jones, J. L., Toronto, Ont.

**1132—CYANIDE OF MERCURY.**

Lyman Bros. & Co. Ltd., Toronto, Ont.

**1133—CYLINDERS—Soldering.**

Brown, Boggs & Co., Hamilton, Ont. *Advt. page* 193.

**1134—CYLINDERS—Pump, (Iron).**

Carrier, Laine & Co., Levis, Que. *Advt. page* 150.  
Garth & Co., Montreal, Que. *Advt. page* 154.  
McDougall, R. & Co., Galt, Ont. *Advt. page* 199.  
Smart, (The Jas.), Mfg Co., Brockville, Ont. *Advt.* 178.  
Young Bros., Almonte, Ont. *Advt. page* 250.  
Matheson, I. & Co., New Glasgow, N. N. *Advt.* 200.  
Laurie Engine Co., Montreal, Que. *Advt. page* 179.

**1135—CYLINDERS—Copper Brass.**

Booth Copper Co., Toronto, Ont. *Advt. page* 155.  
Macdonald & Co. Ltd., Halifax, N. S. *Advt. page* 256.  
Matheson, I. & Co., New Glasgow, N. S. *Advt.* 200.  
Morrison, Jas. Brass Mfg Co., Toronto, Ont. *Advt.* 157.  
Coulter & Campbell, Toronto, Ont. *Advt. page* 201.  
McDougall, R. & Co., Galt, Ont. *Advt. page* 199.  
McAvity, T. & Sons, St. John, N. B. *Advt. page* 153.  
Parker, J. O. & Co., Toronto, Ont. *Advt. page* 253.  
Carrier, Laine & Co., Levis, Que. *Advt. page* 150.  
Laurie Engine Co., Montreal, Que. *Advt. page* 179.

**1136—CYLINDERS—Brass Lined, Iron Lined, Shallow Weel, Deep Weel, Oil Weel.**

McDougall, R. & Co., Galt, Ont. *Advt. page* 199.

**1137—CYLINDERS—Locomotive, Iron, Engine.**

Canadian Locomotive & Engine Co., *Advt. p.* 175.  
Raney, Reid & Selby, Kingston, Ont.  
Carrier, Laine & Co., Levis, Que. *Advt. page* 150.  
Matheson, I. & Co., New Glasgow, N. S. *Advt.* 200.  
Jenckes Machine Co., Sherbrooke, Que. *Advt. p.* 165.  
Brown, (G. & J.) Mfg Co., Belleville, Ont. *Advt. p.* 198.  
Goldie & McCulloch Co. Ltd., Galt, Ont. *Advt. p.* 159.  
Rathbun Co. (The), Deseronto, Ont. *Advt. page* 162.

**1138—CYLINDERS—Dying.**

Coulter & Campbell, Toronto, Ont. *Advt. page* 201.

**1139—DAMPERS—Stove Pipe.**

Paris Electric Plating Co., Paris Station, Ont.  
Smart Mfg Co. (Jas.), Brockville, Ont. *Advt. p.* 178.  
Ives, H. R. & Co., Montreal, Que. *Advt. page* 200.

**1140—DAMPERS—Furnace.**

Star Iron Co., Montreal, Que. *Advt. page 243.*

**1141—DAMS—Dental.**

Alpha Rubber Co. Ltd., Montreal, Que.  
Canadian Rubber Co., Montreal, Que. *Advt. p. 197.*

**1142—DAMS—Steel, Swing, Moveable.**

Central Bridge & Engineering Co. Ltd., Peterboro,  
Ont. *Advt. page 214.*

**1143—DASHBOARDS—Wicker.**

Pelosse, P., Montreal, Que. *Advt. page 234.*

**1144—DASHES—Buggy.**

McKinnon Dash & Hardware Co., St. Catharines,  
Ont. *Advt. page 202.*

**1145—DAUBERS—Shoe. See Brushes No. 514.****1146—DECKING—Ship.**

Edwards, W. C. & Co. Ltd., Ottawa, Ont. *Advt. 219.*

**1147—DECORATIONS—(Plaster), Fibrous, Wall, Ceiling.**

Hynes, William J., Toronto, Ont.

**1148—DELICATINE.**

Pure Gold Mfg Co., Toronto, Ont.

**1149—DEMIJOHNS—Glass,**

Lamont Glass Co., New Glasgow, N. S. *Advt. 231.*

**1150—DENIMS.**

Hamilton Cotton Co., Hamilton, Ont. *Advt. p. 188.*

**1151—DERRICKS—Construction, Mining & Quarry, Pile Driving Revolving Steam.**

Beatty, M. & Sons, Welland, Ont. *Advt. page 173.*  
Ingersoll Rock Drill Co., Montreal, Que. *Advt. 198.*  
Kerr & Morgan, Montreal, Que. *Advt. page 220.*  
Jenckes Machine Co., Sherbrooke, Que. *Advt. p. 165.*  
Carrier, Laine & Co., Levis, Que. *Advt. page 150.*  
Miller Bros. & Toms, Montreal, Que. *Advt. page 197.*  
Brown Mfg Co. (G. & J.), Belleville, Ont. *Advt. p. 198.*

**1152—DESKS—Automatic School, The Globe.**

Globe Furniture Co., Walkerville, Ont. *Advt. p. 225.*

**1153—DESKS—(Cabinet), Writing, Ladies' Library.**

Canadian Office & School Furniture Co. Ltd. (The),  
Preston, Ont. *Advt. page 210.*  
Globe Furniture Co., Walkerville, Ont. *Advt. p. 225.*  
Tees & Co., Montreal, Que. *See page 225.*

**1154—DESKS—Music. See No. 571.****1155—DESKS—(Office), Roll Top & Cylinder, (Cabinet, Secretaries, Table).**

Canadian Office & School Furniture Co. (The),  
Preston, Ont. *Advt. page 210.*  
Globe Furniture Co. Ltd., Walkerville, Ont. *Advt. 225.*  
Rhodes, Curry & Co. Ltd., Amherst, N. S. *Advt. 158.*  
Tees & Co., Montreal, Que. *Advt. page 225.*  
Snider, John B., Waterloo, Ont. *Advt. page 231.*

**1156—DESKS—(Iron Frame), School.**

Globe Furniture Co. Ltd., Walkerville, Ont. *See p. 225.*  
Smart James Mfg Co., Brockville, Ont. *See page 178.*  
Snider, John B., Waterloo, Ont. *See page 231.*

Moffat & Co., Carleton Place, Ont.  
Bessette, J. & S., Itherville, Que.  
Valleyfield Foundry & Machine Works, Valleyfield,  
Que. *See page 191.*

**1157—DESKS—(Tin) Coffee.**

Macdonald Mfg Co., Toronto, Ont.

**1158—DESIGNS—Wood.**

Flewelling C. H., St. John, N.B.

**1159—DESIGNS—Wire Floral. See No. 159.****1160—DESIGNINGS—(for illustrations).**

Canadian Photo-Engraving Bureau, Toronto, Ont.  
*See page 239.*

**1161—DETECTORS—Low Water.**

Garth & Co., Montreal, Que. *See page 154.*

**1162—DEVICES—(Oiling), Crank Pin.**

*See Oilers.*

**1163—DIAPERS—Rubber. See No. 2869.****1164—DIAPHRAGMS—Rubber.**

Canadian Rubber Co., Montreal, Que. *See page 197.*  
Gutta Percha & Rubber Mfg Co. Ltd., Toronto, Ont.  
*Back cover.*

**1165—DIARIES—Office, Pocket.**

Gage, (W. J.) Co. Ltd., Toronto, Ont. *See p. 189.*  
Brown Bros. Ltd. (The), Toronto, Ont.

**1166—DIES—Jewelers'.**

Patterson & Heward, Toronto, Ont. *See page 201*  
Fell I. C. & Co., Toronto, Ont.

**1167—DIES—Drop.**

Gillies, George Co., Gananoque, Ont. *See page 156.*

**1168—DIES—Stencil.**

Pritchard & Andrews, Ottawa, Ont. *See page 250.*  
Patterson & Heward, Toronto, Ont. *See page 201.*  
Fell, I. C. & Co., Toronto, Ont.  
Lane, William & Co., Montreal, Que.  
Dawson, G. W., Montreal, Que.  
Cox, George, Ottawa, Ont.

**1169—DIES—Adjustable Round, Bit Brace Bolt, Solid Round, Stay Bolt. See No. 3282.****1170—DIES—Brass, Hat Tip, Soap, Stamp, Steel.**

Patterson & Heward, Toronto, Ont. *See page 201.*  
Pritchard & Andrews, Ottawa, Ont. *See p. 250.*

**1171—DIES—Canners', Copping, Blanking, Drawing, Tanners'.**

Brown, Boggs & Co., Hamilton, Ont. *See page 193.*  
Starr Mfg Co. Ltd., Halifax, N. S. *See page 199.*

**1172—DIES—Chilled Iron, Chromo Steel, Ore Crushing.**

Jenckes Machine Co., Sherbrooke, Que. *See p. 165.*

**1173—DIES—Boot & Shoe, Leather Cutting.**

Hocking Thomas, Montreal, Que.

**1174—DIES—Ticket Punch.**

Butterfield & Co., Rock Island, Que.

**1175—DIES & PUNCHES—Steel.**

Bertram, John & Sons, Dundas, Ont. *See page 161.*

- Brown, Boggs & Co., Hamilton, Ont. *See page 193.*  
 Jardine, A. B. & Co., Hespeler, Ont. *See page 217.*
- 1176—DIGESTIVE FERMENTS.**  
 Parke, Davis & Co., Walkerville, Ont.
- 1177—DIGGERS—Post Hole (Hand)**  
 Ives, H. R. & Co., Montreal, Que. *See page 200.*  
 Otterville Mfg Co. Ltd., Otterville, Ont. *See page 259.*  
 Whitman & Barnes Mfg Co., St. Catharines, Ont.
- 1178—DIGGERS—Potato.**  
 Moody, Matthew & Sons, Terrebonne, Que. *See p. 209.*
- 1179—DILATORS—Rubber.** *See No. 2869.*
- 1180—DIPPERS—Copper.** *See No. 2181.*
- 1181—DISHES—Glass.**  
 Dominion Glass Works, Montreal, Que. *See page 221.*
- 1182—DISHES—Oval Butter.**  
 Oval Wood Dish Co., Essex Center, Ont.
- 1183—DISHES—Iron Soap.**  
 Young & Bro. Co. Ltd., Hamilton, Ont. *See page 257.*  
 Toronto Steel Clad Bath & Metal Co. Ltd. (The),  
 Toronto, Ont. *Advt. page 155.*
- 1184—DISHES—(Veneer), Butter, Lard.**  
 Acme Veneer Works, Orillia, Ont. *See Page 217.*
- 1185—DISKS—Harrow.**  
 Waterloo Mfg Co. Ltd., Waterloo, Ont. *See page 218.*  
 Nova Scotia Steel Co. Ltd., New Glasgow, N.S.  
 Wortman & Ward Mfg Co., London, Ont.
- 1186—DISTRIBUTORS—Gas, Fire, Clay, Fire  
 Place.**  
 Campbell, R., Hamilton, Ont. *See page 230.*
- 1187—DITCHER—Automatic Tile.**  
 Mackenzie, D., St. Thomas, Ont.
- 1188—DITCHERS & EXCAVATORS—County,  
 Railroad, Canal, Steam.** *See Dredges No. 1203.*
- 1189—DOGS—DIE.**  
 Bertram, John & Sons, Dundas, Ont. *See page 161.*
- 1190—DOGS—Cant, Clamp, Saw Mill.**  
 Wallace, William, Three Rivers, Que. *See page 216.*  
 Carrier, Laine & Co., Levis, Que. *See page 150.*  
 Goldie & McCulloch Co. Ltd., Galt, Ont. *Advt. 159.*  
 Lancaster Machine Works, Lancaster, Ont. *Advt. 248.*  
 Chalifoux, O. & Sons, St. Hyacinthe, Que. *Advt. 232.*  
 Drake, F. J., Belleville, Ont. *Advt. page 175.*
- 1191—DOGS—Malleable Lathe.**  
 Kyle, P., Merrickville, Ont.  
 Robb Engineering Co. Ltd., Amherst, N.S.  
*See inside front cover.*  
 Malleable Iron Co., Montreal, Que.  
 Frost, W. H., Smith's Falls, Ont.
- 1192—DOGS—Lathe.**  
 Butterfield & Co., Rock Island, Que.  
 Gardner, Robt. & Son, Montreal, Que.
- 1193—DOMES—Glass.**  
 Dominion Glass Works, Montreal, Que. *Advt. p. 221.*

- 1194—DOORS—(Iron), Sweep Hole, Soot.**  
 Ives, H. R. & Co., Montreal, Que. *Advt. page 200.*  
 Carrier, Laine & Co., Levis, Que. *Advt. page 150.*  
 Smart (James), Mfg Co., Brockville, Ont. *Advt. 178.*
- 1195—DOORS—(Iron) Cemetery Vault, Build-  
 ing, Fireproof, Jail, Vault.**  
 Goldie & McCulloch Co. Ltd., Galt, Ont. *Advt. 159.*  
 Ives, H. R. & Co., Montreal, Que. *Advt. page 200.*  
 Dennis Wire & Iron Works, London, Ont. *Advt. 207.*  
 Starr Mfg Co. Ltd., Halifax, N.S. *Advt. page 199.*  
 Carrier, Laine & Co., Levis, Que. *Advt. page 150.*
- 1196—DOORS—Box Stall, Stable.** *See No. 1831.*
- 1197—DOORS—Brick Kiln, Boiler.**  
 Carrier, Laine & Co., Levis, Quebec. *Advt. page 150.*  
 Garth & Co., Montreal, Que. *Advt. page 154.*  
 Jenckes Machine Co., Sherbrooke, Que. *Advt. 165.*  
 Gardner, R. & Sons, Montreal, Que.  
 Matheson, I. & Co., New Glasgow, N.S. *Advt. 200.*  
 Brush, Geo., Montreal, Que.
- 1198—DOORS—Plain, Mahogany, Walnut.**  
 Rathburn Co. (The), Deseronto, Ont. *Advt. p. 162.*
- 1199—DOORS—(Screen), Framed.**  
 Rhodes, Curry & Co., Amherst, N.S. *Advt. page 158.*
- 1200—DOORS—Panel, Raised Panel.**  
*See No. 2898.*
- 1201—DRAWERS—Ribbed Knitted Cotton,  
 Woolen.**  
 Eagle Knitting Co., Hamilton, Ont. *Advt. page 184.*  
 Turnbull, C. & Co. Ltd., Galt, Ont. *Advt. page 203.*
- 1202—DRAWERS—Money.**  
 Gurney Scale Co., Hamilton, Ont. *Advt. page 244.*
- 1203—DREDGES—Boom, Clam Suction, Dip-  
 per, Ditching, Grappler, Hydraulic,  
 Spoon & Elevator, Steam.**  
 Beatty, M. & Sons, Welland, Ont. *See page 173.*  
 Carrier, Laine & Co., Levis, Que. *See page 150.*
- 1204—DRESS GOODS—Woolen, Cheviots,  
 Ladies' Vests.**  
 Taylor, T. H. Co., Ltd., Chatham, Ont. *See p. 236.*  
 Granite Mills Co., St. Hyacinthe, Que.  
 Forbes Co. Ltd. (The R.), Hespeler, Ont.  
 Brodie & Co., Hespeler, Ont.  
 Yarmouth Woolen Mills Co. Ltd., Yarmouth, N. S.  
 Lomas Adam & Son, Sherbrooke, Que.  
 Cornwall Mfg Co., Cornwall, Ont.
- 1205—DRESSERS—Hoop, Stave.**  
 Goldie & McCulloch Co. Ltd., Galt Ont. *See p. 159.*  
 McKeough & Trotter, Chatham, Ont.  
 Park Bros., Chatham, Ont.
- 1206—DRESSERS—Buhr Stone, Emery  
 Wheel.**  
 Hart Emery Wheel Co., Hamilton, Ont. *Advt. p. 166.*  
 Prescott Emery Wheel Co., Prescott, Ont. *Advt. 237.*
- 1207—DRESSERS—Huntington's Emery  
 Wheel.**  
 Hart Emery Wheel Co., Hamilton, Ont. *Advt. p. 166.*
- 1208—DRESSES—Infants'. See No. 3609.**

**1209—DRESSING—Boot & Shoe, Boot & Shoe Paste, Harness, Liquid, Tan.**

Domestic Specialty Co., Hamilton, Ont. *Advt. p. 227.*  
McCrea, Hanes Co., Toronto, Ont. *Advt. page 248.*

**1210—DRESSING—Belt.**

Young & Bro. Co. Ltd., Hamilton, Ont. *Advt. p. 257.*  
McLaren Belting Co. (The J. C.), Montreal, Que.  
Robin, Sadler & Haworth, Montreal, Que. *Advt. 226.*  
Goodhue, J. L., Danville, Que. *Advt. page 236.*

**1211—DRILLS—Automatic, Bench, Goose-neck, Radial, Suspension, Traverse, Sensitive, Upright.**

Bertram, John & Sons, Dundas, Ont. *Advt. page 161.*  
Gardner, R. & Son, Montreal, Que.  
Stevens, Hamilton & Co., Galt, Ont.

**1212—DRILLS—Seed, (Horse & Hand).**

Hamilton Mfg Co. (Peter), Peterboro, Ont. *Advt. 209.*  
Noxon Bros. Mfg Co., Ingersoll, Ont.  
Gowdy Mfg Co., Guelph, Ont.

**1213—DRILLS—Grain. Seed, Force Feed.**

Hamilton Mfg Co. (Peter), Peterboro, Ont. *Advt. 209.*  
Noxon Bros. Mfg Co., Ingersoll, Ont.

**1214—DRILLS—Coal, Cone, Power, Prospecting Core, See No. 1217.**

**1215—DRILLS—Bell Hangers, Bow, Breast, Hand, Ratchet.**

Jardine, A. B. & Co., Hespeler, Ont. *Advt. page 217.*  
Butterfield & Co., Rock Island, Que.  
Thompson, Joseph, St. John, N. B.

**1216—DRILLS—Boiler Shell, Metal Working Mach'y, Multiple Spindle, Self-Feeding:**

Bertram, John & Sons, Dundas, Ont. *Advt. page 161.*  
Gardner, R. & Sons, Montreal, Que.  
Stephens, Hamilton & Co., Galt, Ont.

**1217—DRILLS—Compressed Air, Diamond, Rock, Steam, Stone.**

Canadian Rand Drill Co., Sherbrooke, Que. *Advt. 165.*  
Ingersoll Rock Drill Co. Montreal, Que. *Advt. p. 198.*  
Mac Machine Co., Belleville, Ont. *Advt. page 194.*

**1218—DRILLS—Bit Stock, Center, Coopers' Dowel, Flute, Machine Bit, Spoon Bit, Taper, Bit Brace, Portable.**

Bertram, John & Sons, Dundas, Ont. *Advt. page 161.*  
Smart (Jas.) Mfg Co., Brockville, Ont. *Advt. page 178.*  
Jardine, A. B. & Co., Hespeler, Ont. *Advt. page 217.*  
Stevens, Hamilton & Co., Galt, Ont.  
Whitman & Barnes Mfg Co., St. Catharines, Ont.

**1219—DRILLS—Blacksmiths, Flat, Increase Twist, Mining, Shank, Tap, Twist.**

Ives, H. R. & Co., Montreal, Que. *Advt. page 200.*  
Jardine, A. B. & Co., Hespeler, Ont. *Advt. page 217.*  
Whitman & Barnes Mfg Co., St. Catharines, Ont.  
Butterfield & Co., Rock Island, Que.

**1220—DRILLS—Seed & Roller Combined.**

Vessot, S. & Co., Joliette, Que. *Advt. page 238.*

**1221—DRILLS—Iron & Steel Rail.**

Bertram, John & Sons, Dundas, Ont. *Advt. page 161.*

Canada Spring & Switch Mfg Co., Montreal, Que.

*Advt. page 217.*

Smart, (Jas.) Mfg Co., Brockville, Ont. *Advt. p. 178.*  
Brown, (G. & J.) Mfg Co., Belleville, Ont. *Advt. p. 198.*

**1222—DRIVERS—Pile.**

Beatty, M. & Son, Welland, Ont. *Advt. page 173.*  
Carrier, Lain & Co., Levis, Que. *Advt. page 150.*  
Hood, William & Sons, Montreal, Que. *Advt. p. 252.*

**1223—DROPPERS—Medicine. See No. 2869.**

**1224—DRUM—Patent Stove Pipe.**

Dobbin, Drum Co. (The), St. Jacobs, Ont.

**1225—DRUMS—Brass, Kettle, Orchestra, Snare.**

Whaley & Royce Piano Co., Toronto, Ont. *Advt. 189.*

**1226—DRUMS—Conical, Cylindrical, Hoisting, Mud, Rope Driving, Winding.**

*See Hoists No. 1729.*

**1227—DRYERS—Wool.**

Goldie & McCulloch Co. Ltd., Galt, Ont. *Advt. 159.*  
Frind, Paul, Woollen Machy Co., Toronto, Ont.  
*Advt. page 249.*

**1228—DRYERS—Paper & Pulp.**

Bertram, John & Sons, Dundas, Ont. *Advt. page 161.*  
Carrier, Laine & Co., Levis, Que. *Advt. page 150.*

**1229—DRYERS—Liquid, Japan, Transparent.**

*See Varnishes No. 3636.*

**1230—DUCK—(Cotton), Enamelled, Oiled.**

Dominion Oil Cloth Co., Montreal, Que. *Advt. p. 201.*

**1231—DUCK—(Cotton), Fancy.**

Canadian Colored Cotton Mills Co. Ltd., Montreal, Que. *Advt. page 181.*  
Parks, William & Son Ltd., St. John, N.B. *Advt. 233.*  
Yarmouth, Duck & Yarn Co., Yarmouth, N.S.

**1232—DUMPERS—Furnace.**

Gurney, Tilden Co. Ltd., Hamilton, Ont. *Advt. 151.*  
Smart (James), Mfg Co., Brockville, Ont. *Advt. 178.*

**1233—DUST—Cork.**

Cork Co. of Canada Ltd., Toronto, Ont. *Advt. p. 187.*

**1234—DUST—Marble.**

Canadian Granite Co. Ltd., Ottawa, Ont.

**1235—DUSTERS—Barbers', Carriage, Feather, Furniture, Moulders', Painters', Parlor & Mantle. See No. 510.**

**1236—DUSTERS, Bran.**

Goldie & McCulloch Co. Ltd., Galt, Ont. *Advt. p. 159.*

**1237—DUSTERS—Rag, Waste, Wool.**

Goldie & McCulloch Co. Ltd., Galt, Ont. *Advt. p. 159.*  
Young Bros., Almonte, Ont. *Advt. page 250.*  
Karch, H. W., Hespeler, Ont.

**1238—DYES—Aniline, Dyestuffs.**

Drouin Bros. & Co., Quebec, Que.  
Brayley, Sons & Co., Montreal, Que.  
Dominon Dye Wood & Chemical Co., Toronto, Ont.  
Young & Son, Montreal, Que.  
Wells & Richardson Co., Montreal, Que.

**1239—DYNAMITE.**

Acadia Powder Co. Ltd., Halifax, N. S. *Advt. p. 240.*  
Hamilton Powder Co., Montreal, Que. *Advt. p. 196.*

**1240—DYNAMOS—Power, Marine, See No. 2237.****1241—EARS—(Brass)—Kettle. See kettles No. 1893.****1242—EARS—(Iron), Coal Hod, Kettle, Pail, Tea Kettle.**

Parmenter & Bulloch, Gananoque, Ont. *Advt. p. 199.*  
Burrow, Stewart & Milne, Hamilton, Ont.  
Frost, W. H., Smith's Falls, Ont.  
Kyle, P., Merrickville, Ont.

**1243—EARPHONES—Metal.**

Chadwick Bros., Hamilton, Ont. *Advt. page 206.*

**1244—EARTHENWARE—Plumbers', Sanitary.**

Dominion Sanitary Potter Co., St. John, N.B.  
*Advt. page 253.*  
Campbell, R., Hamilton, Ont. *Advt. page 230.*  
St. Johns Stone Chinaware Co., St. Johns, Que.  
Campbell & Purvis, St. Johns, Que.

**1245—EASELS—Brass.**

Hamilton Brass Mfg Co., Hamilton, Ont. *Advt. 168.*  
Chadwick Bros., Hamilton, Ont. *Advt. page 206.*

**1246—EASELS—Wire.**

Dennis Wire & Iron Works, London, Ont. *See p. 207.*

**1247—EASELS—Bamboo, Enamelled, Gold Finished, Rattan.**

Gendron Mfg Co. Ltd., Toronto, Ont. *See page 187.*  
Thompson, Alexander & Co., Hamilton, Ont.  
Otterville Mfg Co. Ltd., Otterville, Ont. *See p. 259.*

**1248—ECONOMIZERS—Fuel.**

Babcock & Wilcox Co., Montreal, Que. *See p. 194.*

**1249—EDGERS—Turf. See Scythes No. 2950.****1250—EDGERS—Box, (Power Feed).**

Mayo, W. S., Ottawa, Ont. *See page 205.*

**1251—EDGERS—Gang, (Power Feed).**

Lloyd Mfg Co., Kentville, N. S.

**1252—EDGERS—Double, Gang Saw, Lumber.**

Robb Engineering Co. Ltd. Amherst, N. S.  
*See inside front cover.*  
Waring, White & Co., St. John, N. B. *Advt. p. 256.*  
Canadian Locomotive & Engine Co., Kingston, Ont.  
*Advt. page 175.*  
Three Rivers Iron Works, Three Rivers, Que.  
*Advt. page 179.*

**1253—EDGES—(Straight), Saw, Steel.**

Robertson, Jas. Co. Ltd., Toronto, Ont. *Advt. p. 167.*  
Ballantine, John & Co., Preston, Ont. *Advt. p. 205.*

**1254—EDGES—(Straight), Wood.**

Magee Mfg Co. Ltd. London, Ont.

**1255—EDGINGS—Leather. See No. 1966.****1256—EJECTORS.**

Pemberthy Injector Co., Windsor, Ont. *Advt. p. 164.*

**1257—EJECTORS—Hancock, Gem.**

*See Nos. 2488, 2491, 2493.*  
Morrison Brass Mfg Co. Ltd. (James), Toronto, Ont.  
*Advt. page 157.*

**1258—ELECTROLIERS—Car.**

American Copper Co. (The), Toronto, Ont. *Advt. 157.*  
Ness, McLaren & Bate, Montreal, Que. *Advt. p. 240.*

**1259—ELECTROTYPES & STEREOTYPES.**

Central Press Agency, Toronto, Ont.  
National Electrotype & Stereotype Co., Toronto, Ont.  
Lovell, Joseph, Montreal, Que.  
Stereotype Plate Co. of Ontario Ltd., Toronto, Ont.  
Montreal Photo-Engraving Co. (The), Montreal, Que.

**1260—ELEVATORS—Compression System, Direct Pumping System, Tank System.**

Myers, W. F. & J. W., St. John, N.B. *Advt. p. 163.*

**1261—ELEVATORS—Hand Power, Hydraulic, Steam Power. See No. 1265.****1262—ELEVATORS—Flour Mill, Grain.**

Goldie & McCulloch Co. Ltd., Galt, Ont. *Advt. 159.*

**1263—ELEVATORS—Coal, Steam Hod.**

Carrier, Laine & Co., Levis, Que. *Advt. page 150.*  
Brush, Geo., Montreal, Que.  
Miller Bros. & Toms, Montreal, Que. *Advt. p. 197.*  
Kerr & Morgan, Montreal, Que. *Advt. page 220.*

**1264—ELEVATORS—Sidewalk, (Hand).**

*See No. 1265.*

**1265—ELEVATORS—Electric, Freight, Factory, Passenger, Warehouse.**

Myers, W. F. & J. W., St. John, N. B., *Advt. p. 163.*  
Kerr & Morgan, Montreal, Que. *Advt. page 220.*  
Fensom, John, Toronto, Ont.  
Miller Bros. & Toms, Montreal, Que. *Advt. page 197.*  
Leitch & Turnbull, Hamilton, Ont.

**1266—ELEVATORS—Saw Dust.**

Brush, Geo., Montreal, Que.

**1267—ELIXIRS—Elixirs of Calisaya, &c.**

Lyman Bros. & Co. Ltd., Toronto, Ont.  
Stearns, Fred'k & Co., Windsor, Ont. *See back cover.*

**1268—ELIXIRS—Kola Compound, Pepsin Lactated.**

Parke, Davis & Co., Walkerville, Ont.

**1269—EMBLEMS—Terra Cotta.**

Rathbun Co. (The), Deseronto, Ont. *See page 162.*  
Beamsville Pressed Brick Co., Beamsville, Ont.  
*Advt. page 215.*

**1270—EMBLEMS—Masonic & Society.**

*See Jewels No. 1867.*

**1271—EMBROIDERIES—Bullion, Gold & Silver, Name Letter.**

Coddington, W. H., Hamilton, Ont.

**1272—EMBROIDERIES—Swiss.**

Mahony & Co., Toronto, Ont.

**1273—EMERY.**

Prescott Emery Wheel Co. Ltd., Prescott, Ont.  
*Advt. page 237.*  
Hart Emery Wheel Co., Hamilton, Ont. *Advt. p. 169.*



**1274—EMULSION—Cod Liver Oil.**Stearns, Fred'k. & Co., Windsor, Ont. *See back cover.***1275—EMULSION—Puttners.**

Brown &amp; Webb, Halifax, N.S.

**1276—ENAMEL—Stovepipe, (odorless).***See No. 1209.***1277—ENAMEL—Elastic, Bicycle.**

Macdonald Mfg Co., Toronto, Ont.

**1278—ENCLOSURES & GUARDS—(Wire and Iron), Elevator.**Dennis Wire & Iron Works, London, Ont. *Advt. 207.*McAvity, T. & Sons, St. John, N.B. *See page 153.*Myers, W. F. & J. W., St. John, N.B. *See page 163.***1279—ENDS—Bolt.**Gillies, Geo. Co. Gananoque, Ont. *See page 156.*

Morrow Machine Screw Co. (John), Engersoll, Ont.

*See page 260.*

Swansea Forging Co. Ltd., (The), Swansea, Ont.

*Advt. page 156.***1280—ENDS—Church Pew, Iron.***See No. 2954.***1281—ENDS—Joint, Stay, Pole.**

Swansea Forging Co. Ltd. (The), Swansea, Ont.

*Advt. page 156.*Gillies, Geo. (The) Co., Gananoque, Ont. *See p. 156.***1282—ENDS—Brass Cylinder.**Chadwick Bros., Hamilton, Ont. *See page 206.***1283—ENDS—Pole.***See No. 1281.***1284—ENGINES—Electric Lighting.***See No. 1288.***1285—ENGINES—Automatic Cut-Off "Corliss."**Jenckes Machine Co., Sherbrooke, Que. *See p. 165.***1286—ENGINES—Automatic Coal Oil.**

Gillies, John &amp; Co., Carleton Place, Ont.

**1287—ENGINES—(Steam), Automatic Cut-Off "Wheelock."**Goldie & McCulloch Co. Ltd., Galt, Ont. *See p. 159.***1288—ENGINES—Automatic High Speed, Steam Automatic Cut-Off, Compound Condensing.**Laurie Engine Co., Montreal, Que. *See page 179.*Canadian Locomotive & Engine Co. Ltd., Kingston, Ont. *See page 175.*Carrier, Laine & Co., Levis, Que. *See page 150.*Fraser Bros., New Glasgow, N.S. *See page 252.*

Burrell-Johnson Iron Co., Yarmouth, N.S.

Goldie & McCulloch Co. Ltd., Galt, Ont. *See p. 159.*Matheson, I. & Co., New Glasgow, N.S. *See p. 200.*Kerr Engine Co. Ltd., Walkerville, Ont. *See p. 208.*

Brush, George, Montreal, Que.

Robb Engineering Co. Ltd., Amherst, N. S.

*See Inside Front Cover.*

Leonard, E. &amp; Sons, London, Ont.

**1289—ENGINES—Robb, Armstrong.**

Robb Engineering Co. Ltd., Amherst, N. S.

*See inside front cover.***1290—ENGINES & BOILERS—Drilling, Portable, Semi-Portable.**Waring, White & Co., St. John, N.B. *Advt. page 256.***1291—ENGRAVING—Colored Plate, Zinc.**Dominion Engraving Co., Ottawa, Ont. *Advt. p. 186.*

Desbarats &amp; Co., Montreal, Que.

**1292—ENGRAVING—Bill Head, Letter Head.***See No. 1295.***1293—ENGRAVING—Wax.**

Toronto Engraving Co. (The).

**1294—ENGRAVING—Music.**Whaley, Royce & Co., Toronto, Ont. *Advt. page 189.***1295—ENGRAVING—Commercial Steel, Copper Plate, Process.**Dominion Engraving Co., Ottawa, Ont. *Advt. p. 186.*

Toronto Lithographing Co., Toronto, Ont.

Mortimer &amp; Co., Ottawa, Ont.

Alexander &amp; Cable, Toronto, Ont.

Barclay, Clark &amp; Co., Toronto, Ont.

Bishop Eng. &amp; Printing Co., Montreal, Que.

Sabiston Lith. &amp; Pub. Co., Montreal, Que.

Canada Eng. &amp; Litho. Co. Ltd., Montreal, Que.

Rolph, Smith &amp; Co., Toronto, Ont.

**1296—ENGINES—Gas.**Canadian Locomotive & Engine Co. Ltd., Kingston, Ont. *Advt. page 175.*

Bertram Engine Works Co. Ltd. (The), Toronto, Ont.

**1297—ENGINES—High Speed "Armington & Sims."**Canadian Locomotive & Engine Co. Ltd., Kingston, Ont. *Advt. page 175.***1298—ENGINES—Hauling, Hoisting, Portable, Mining, Quarry, Winding, Double & Single Cylinder.**Beatty, M. & Sons, Welland, Ont. *Advt. page 173.*Carrier, Laine & Co., Levis, Que. *Advt. page 150.*

Robb Engineering Co. Ltd., Amherst, N. S.

*See inside front cover.*Mac Machine Co., Belleville, Ont. *Advt. page 194.*Fraser Bros., New Glasgow, N. S. *Advt. page 252.*Laurie Engine Co., Montreal, Que. *Advt. page 179.*

Brush, Geo., Montreal, Que.

Truro Foundry &amp; Machine Co., Truro, N. S.

*Advt. page 198.*Ingersoll Rock Drill Co., Montreal, Que. *Advt. 198.*Jenckes Machine Co., Sherbrooke, Que. *Advt. 165.*Matheson, I. & Co., New Glasgow, N. S. *Advt. 200.*Macdonald & Co. Ltd., Halifax, N. S. *Advt. p. 256.*Waring, White & Co., St. John, N. B. *Advt. p. 256.*Brown, (G. & J) Mfg Co., Belleville, Ont. *Advt. p. 198.***1299—ENGINES—Farm, Straw Burning, Portable, Thrashing, Traction.**

Robb Engineering Co. Ltd., Amherst, N. S.

*See inside front cover.*

Brown, (G. &amp; J.) Mfg Co. Ltd., Belleville, Ont.

*Advt. page 198.*

Brush, Geo., Montreal, Que.

Sawyer &amp; Massey Co., Hamilton, Ont.

Waterloo Mfg Co. Ltd., Waterloo, Ont. *See page 218.***1300—ENGINES—(Steam), Stationary, Vertical, Horizontal, High Speed Vertical, Compound Horizontal, High Speed Horizontal.**

Robb Engineering Co. Ltd., Amherst, N. S.

*See inside front cover.*

- Canadian Locomotive & Engine Co. Ltd., Kingston, Ont. *Advt. page 175.*  
 Nie & Whitfield, Hamilton, Ont.  
 Brown, (G. & J.) Mfg Co., Belleville, Ont. *Advt. 198.*  
 Leonard, E. & Sons, London, Ont.  
 Mac Machine Co., Belleville, Ont. *Advt. page 194.*  
 Jenckes Machine Co., Sherbrooke, Que. *Advt. p. 165.*  
 Laurie Engine Co., Montreal, Que. *Advt. p. 179.*  
 Carrier, Laine & Co., Levis, Que. *Advt. page 150.*  
 Goldie & McCulloch Co. Ltd., Galt, Ont. *Advt. 159.*  
 Kerr Engine Co. Ltd., Walkerville, Ont. *Advt. 208.*  
 Ontario Engine & Machine Co. Ltd., Toronto, Ont. *Advt. page 177.*
- 1301—ENGINES—Side Crank.**  
 Robb Engineering Co. Ltd., Amherst, N. S.  
*See inside front cover.*
- 1302—ENGINES—(Steam), Slide Valve Saw Mill.**  
 Carrier, Laine & Co., Levis, Que. *Advt. page 150.*  
 Goldie & McCulloch Co. Ltd., Galt, Ont. *Advt. 159.*  
 Matheson, I. & Co., New Glasgow, N.S. *Advt. 200.*  
 Waring, White & Co., St. John, N.B. *Advt. page 256.*  
 Fleck, Alex. Jr., Ottawa, Ont. *Advt. page 252.*  
 Jenckes Machine Co., Sherbrooke, Que. *Advt. 165.*  
 Brown, (G. & J.) Mfg Co., Belleville, Ont. *Advt. 198.*  
 Kerr Engine Co. Ltd., Walkerville, Ont. *Advt. p. 208.*
- 1303—ENGINES—Corliss Steam.**  
 Laurie Engine Co., Montreal, Que. *Advt. page 179.*  
 Kerr Engine Co. Ltd., Walkerville, Ont. *Advt. p. 208.*
- 1304—ENGINES—Launch, Yacht.**  
 Carrier, Laine & Co., Levis, Que. *Advt. page 150.*  
 Canadian Locomotive & Engine Co. Ltd., Kingston, Ont. *Advt. page 175.*  
 Macdonald & Co. Ltd., Halifax, N.S. *Advt. page 157.*  
 Matheson, I. & Co., New Glasgow, N.S. *Advt. 200.*  
 Ontario Engine & Machine Co. Ltd., Toronto, Ont. *Advt. page 177.*  
 Waring, White & Co., St. John, N.B. *Advt. page 256.*  
 Ramsay, Reid & Selby, Kingston, Ont.  
 Bertram Engine Works Co. Ltd. (The), Toronto, Ont.
- 1305—ENGINES—Direct Coupled.**  
 Robb Engineering Co. Ltd., Amherst, N.S.  
*See inside front cover.*
- 1306—ENGINES—Pumping, Rolling Mill, Saw & Grist Mill, Waterworks.**  
 Laurie Engine Co., Montreal, Que. *Advt. page 179.*  
 Carrier, Laine & Co., Levis, Que. *Advt. page 150.*  
 Goldie & McCulloch Co., Galt, Ont. *Advt. page 159.*  
 Matheson, I. & Co., New Glasgow, N.S. *Advt. 200.*  
 Robb Engineering Co. Ltd., Amherst, N.S.  
*See inside front cover.*  
 Jenckes Machine Co., Sherbrooke, Que. *Advt. p. 165.*
- 1307—ENGINES—(Steam), Marine, Compound Marine, Steamboat, Reversing.**  
 Bertram Engine Works Co. Ltd. (The), Toronto, Ont.  
 Nie & Whitefield, Hamilton, Ont.  
 Carrier, Laine & Co., Levis, Que. *Advt. page 150.*  
 Brush, George, Montreal, Que.  
 Kerr Engine Co. Ltd., Walkerville, Ont. *Advt. 208.*  
 McKinnon & McLean, Charlottetown, P.E.I.  
 Flemming James, St. John, N. B.  
 Macdonald & Co. Ltd., Halifax, N.S. *Advt. page 256.*  
 Inglis, John & Sons, Toronto, Ont.
- 1308—ENGINES—Blast Blowing, Patent Machine.**  
 Canadian Locomotive & Engine Co. Ltd., Kingston, Ont. *Advt. page 175.*
- 1309—ENGINES—Fire, Rotary Fire.**  
 Carrier, Laine & Co., Levis, Que. *Advt. page 150.*  
 Waterous Engine Works Co. Ltd., Brantford, Ont.  
 Burrell-Johnston Iron Co., Yarmouth, N.S.  
 Ronald, J. D., Brussels, Ont.
- 1310—ENGRAVING—Wood.**  
 Dominion Engraving Co., Ottawa, Ont. *Advt. p. 186.*  
 Canadian Photo-Engraving Bureau, Toronto, Ont. *Advt. page 239.*  
 Walker, J. H., Montreal, Que.  
 Jones, J. L., Toronto, Ont.  
 Wiseman, J. L., Montreal, Que.  
 Hough & Harris, Toronto, Ont.  
 Flewwelling, C. H., St. John, N. B.  
 Toronto Engraving Co. (The), Toronto, Ont.  
 Kramer, W. J., Toronto, Ont. *Advt. page 214.*
- 1311—ENGRAVING—Half Tone.**  
 Dominion Engraving Co., Ottawa, Ont. *Advt. p. 186.*  
 Toronto Engraving Co. (The), Toronto, Ont.  
 Mortimer & Co., Ottawa, Ont.  
 Canada Eng. & Litho. Co. Ltd., Montreal, Que.  
 Canadian Photo Engraving Bureau, Toronto, Ont. *Advt. page 239.*  
 Desbarats & Co., Montreal, Que.
- 1312—ENVELOPES—Commercial, Document Embossed, Government, Mourning, Official, Pay, Railway, Glove.**  
 Gage, (W. J.) Co. Ltd., Toronto, Ont. *Advt. page 189.*  
 Barber & Ellis Co. Ltd., Toronto, Ont. *Advt. p. 192.*
- 1313—ENVELOPES—Clasp, Printed, Tag, Tie-Express, Drug, Manilla, Sample, Catalogue, Seed, Photograph, Waterproof, Cloth Linen, Metal.**  
 Barber & Ellis Co. Ltd., Toronto, Ont. *Advt. p. 192.*  
 Gage, (W. J.), Co. Ltd., Toronto, Ont. *Advt. p. 189.*  
 Morton, Phillips & Co., Montreal, Que.  
 Wilson, J. C. & Co., Montreal, Que.  
 Canada Paper Co. Ltd., Montreal, Que.  
 Manufacturing Stationer's Co. (The), Montreal, Que.
- 1314—ENVELOPES—Plated.**  
 Simpson, Hall, Miller & Co., Montreal, Que. *Advt. page 203.*
- 1315—EQUALIZERS—Stave.** *See No. 1120.*
- 1316—EQUIPMENTS—Electric Railway.**  
 Kay Electric Works, Hamilton, Ont. *Advt. p. 233.*  
 Ahearn & Soper, Ottawa, Ont.
- 1317—ERGOTIN.**  
 Parke, Davis & Co., Walkerville, Ont.
- 1318—ESCAPES—Fire, Folding.**  
 Ives, H. R. & Co., Montreal, Que. *Advt. page 200.*  
 Wallace, William, Three Rivers, Que. *Advt. p. 216.*  
 Loignon, A. & E., Montreal, Que. *Advt. page 247.*
- 1319—ESCUTCHEONS—Door, Drawer, Key Hole, Sliding Door.**  
 Garth & Co., Montreal, Que. *Advt. page 154.*

- Gurney, Tilden Co. Ltd., Hamilton, Ont. *Advt. 151.*  
Peterboro Lock Mfg Co., Peterboro, Ont. *Advt. 219.*
- 1320—ESCUTCHEONS—(Walnut), Drawer.**  
Goulette, O. V., Gananoque, Ont. *Advt. page 214.*
- 1321—ESSENCIA DE CALISAYA (Mosquera—Essence de Coca (Mosquera).**  
Parke, Davis & Co., Walkerville, Ont.
- 1322—ESSENCES FLAVORING.**  
Stearns, Fred'k & Co., Windsor, Ont. *See back cover.*  
Evans & Sons Ltd., Montreal, Que.  
Brown & Webb, Halifax, N. S.
- 1323—ETCHINGS—(Wood), Scroll.**  
Woltz & McMahon, Toronto, Ont. *Advt. page 203.*
- 1324—ETCHINGS—Zinc.**  
Canadian Photo-Eng. Bureau, Toronto, Ont. *Advt. page 239.*  
Dominion Engraving Co., Ottawa, Ont. *Advt. 186.*  
Montreal Photo Engraving Co., Montreal, Que.
- 1325—ETHER—Sulphuric.**  
Lyman Bros. & Co. Ltd., Toronto, Ont.
- 1326—ETHER—Nitrous Concentrated.**  
Stearns, Fred'k & Co., Windsor, Ont. *See back covers.*
- 1327—ETOFFES—Frieze, Overcoating.**  
Granite Mills Co., St. Hyacinthe, Que.  
Taylor, T. H. & Co. Ltd., Chatham, Ont. *Advt. 236.*  
Hamelin & Avers, Lachute Mills, Que. *Advt. p. 188.*  
Harris & Co., Rockwood, Ont.  
Almonte Blanket Mills, Almonte, Ont.  
Brook Woolen Co. Ltd. (The), Simcoe, Ont.  
Humphrey, John A. & Son, Moncton, N.B.  
Montreal Woolen Mills Co., Montreal, Que.
- 1328—EUTHYMOL.**  
Parke, Davis & Co., Walkerville, Ont.
- 1329—EVAPORATORS—Cider, Jelly, Maple Sugar, Sap, Sorgum.**  
Garth & Co., Montreal, Que. *Advt. page 154.*  
Grimm Mfg Co. (G. H.), Montreal, Que.
- 1330—EXCAVATORS—Steam, Excavators & Ditchers.** *See No. 1203.*
- 1331—EXCELSIOR.**  
Ontario Excelsior Mfg Co. Ltd., Chatham, Ont.  
Maitland Excelsior Works, Gorrie, Ont.
- 1332—EXHAUSTER—Can.** *See No. 2630.*
- 1333—EXPANDERS—Boiler Tube.**  
Gardner, Robt. & Sons, Montreal, Que.  
Carrier, Laine & Co., Levis, Que. *Advt. page 150.*  
Jardine, A. B. & Co., Hespeler, Ont. *Advt. page 217.*  
Leonard, E. & Sons, London, Ont.
- 1334—EXPECTORANTS — Anodyne Pine, Anodyne Pine with Tar.**  
Parke, Davis & Co., Walkerville, Ont.
- 1335—EXPLODERS—Explosives, Detonators.**  
Hamilton Powder Co., Montreal, Que. *Advt. p. 196.*  
Dominion Cartridge Co., Montreal, Que. *Advt. 196.*  
Acadia Power Co., Halifax, N.S. *Advt. page 240.*

- 1336—EXPLOSIVES—Ruborite.**  
Canada Explosives Co. Ltd. (The), Halifax, N.S.
- 1337—EXTERMINATORS—Insect.**  
Common Sense Mfg Co., Toronto, Ont.
- 1338—EXTINGUISHERS—Fire.**  
Garth & Co., Montreal, Que. *Advt. page 154.*  
Canadian Fire Extinguisher Co. (The), Montreal, Que. *Advt. page 237.*
- 1339—EXTRACTORS—Honey & Wax.**  
Goold, Shapley & Muir Co., Brantford, Ont. *Advt. page 191.*  
Phillips T. & Co., Orillia, Ont. *Advt. page 259.*  
Russell, W. G., Millbrook, Ont.
- 1340—EXTRACTORS—Stone & Stump.**  
Kimball, S. S., Montreal, Que. *Advt. page 228.*
- 1341—EXTRACTORS—Hydraulic.**  
Goldie & McCulloch Co. Ltd., Galt, Ont. *Advt. 159.*
- 1342—EXTRACTORS—Cheese.**  
Lancaster Machine Works, Lancaster, Ont. *Advt. 248.*  
Macpherson, D. M., Lancaster, Ont.
- 1343—EXTRACTS—Bottlers', Confectioners', Flavoring.**  
Stearns, Fred'k & Co., Windsor, Ont. *See back cover.*  
Century Co., Picton, Ont. *Advt. page 246.*  
Pure Gold Mfg Co., Toronto, Ont.  
Lyman, Sons & Co., Montreal, Que.  
Snow Drift Co., Brantford, Ont.  
Edwards, C. M. & Co., Toronto, Ont.  
Seely Mfg Co., Windsor, Ont.
- 1344—EXTRACTS—Dyewood, Logwood.**  
Drouin Bros. & Co., Quebec, Que.  
Young & Son, Montreal, Que.  
Brayley, Sons & Co., Montreal, Que.
- 1345—EXTRACTS—Soluble, Tonka, Vanilla.**  
Seely Mfg Co., Windsor, Ont.
- 1346—EXTRACT—Malt.**  
Parke, Davis & Co., Walkerville, Ont.
- 1347—EXTRACTS—(Fluid, Solid, Powdered, Witch Hazel Concentrated, Distilled).**  
Parke, Davis & Co., Walkerville, Ont.
- 1348—EXTRACTS—Witch Hazel, Bark, Buchu Fluid, Medicinal.**  
Lyman, Bros. & Co. Ltd., Toronto, Ont.  
Stearns, F. & Co., Windsor, Ont. *See back cover.*
- 1349—EXTRACTS—Fluid Assayed, Fluid Cascara Aromatic.**  
Stearns, Fred'k & Co., Windsor, Ont. *See back cover.*
- 1350—EYES—Ships Dead.**  
Frizzell, Alexander, Halifax, N.S.
- 1351—EYES—Neck Yoke, Pole & Shaft.**  
Gillies Geo. Mfg Co., Gananoque, Ont. *See page 156.*  
Frost, W. H., Smith's Falls, Ont.  
Burrow, Stewart & Milne, Hamilton, Ont.
- 1352—EYEBARS—Bridge.**  
Central Bridge & Engineering Co. Ltd., Peterborough, Ont. *See page 214.*

**1353—EYELETS—Carriage.**

Peterboro Lock Mfg Co., Peterboro, Ont. *See page 219.*  
 McKinnon, Dash & Hardware Co., St. Catharines,  
 Ont. *See page 202.*

**1353 a—FACTORIES—Butter & Cheese.**

The Agricultural Departments of the different  
 Provinces will be pleased to furnish names and  
 addresses of all such on application.

**1354—FANCY WORK—Indian, Snow Shoes,  
Toboggans.**

Dumas, Raphael, Indian Lorette, Que.  
 GrosLouis, Francis, Indian Lorette, Que.  
 Paul, Thomas, Indian Lorette, Que.  
 Sioui, Morice, Indian Lorette, Que.

**1355—FANS—Hot Blast.**

Robb Engineering Co. Ltd., Amherst, N.S.  
*See inside front cover.*

**1356—FANS—Suction, Exhaust.**

Field Charles, Toronto, Ont.

**1357—FANS—Advertising.**

Toronto Lithographing Co., Toronto, Ont.

**1358—FANS—Electric.**

Toronto Electrical Works, Toronto, Ont.  
 Canadian General Electric Co. Ltd., Toronto, Ont.  
 Royal Electric Co., Montreal, Que.  
 Montreal Electric Co., Montreal, Que.

**1359—FANS—Elevator.**

Miller, Bros. & Toms, Montreal, Que. *See page 197.*  
 Kerr & Morgan, Montreal, Que. *Advt. page 220.*

**1360—FANS—Wing Disk,**

Frind, Paul, Woollen Machinery Co., Toronto, Ont.  
*Advt. page 249.*

**1361—FACINGS—Foundry.**

Hamilton Facing Mill Co., Hamilton, Ont.  
*Advt. page 193.*  
 Dominion Foundry Supply Co., Montreal, Que.  
*Advt. page 266.*

**1362—FASTENERS—Curtain (Vehicle).**

*See dashes No. 1144.*

**1363—FASTENERS—Conductor, Pipe.**

*See pipes No. 2498.*

**1364—FASTENERS—Belt, Hook.**

Forrester, Thos., Montreal, Que. *See front fly leaf.*

**1365—FASTENERS—Glove Spring.**

Hocking, Thomas, Montreal, Que.

**1366—FASTENERS—"Starr's Patent" Cor-  
rugated Steel.**

Ontario Tack Co., (The), Hamilton, Ont. *Advt. 180.*

**1367—FASTENERS—Bedstead.**

Smart, (James) Mfg Co., Brockville, Ont. *Advt. 178.*  
 Cowan & Britton, Gananoque, Ont.  
 Burrow, Stewart & Milne, Hamilton, Ont.

**1368—FAUCETS—Brass, Bung, Lock, Self  
Closing.**

Mitchell, Robt. & Co., Montreal, Que. *Advt. p. 213.*  
 Morrison James Brass Mfg Co. Ltd, Toronto, Ont.  
*Advt. page 157.*

Garth & Co., Montreal, Que. *Advt. page 154.*  
 Hamilton Brass Mfg Co., Hamilton, Ont. *Advt. 168.*  
 Parker, J. O. & Co., Toronto, Ont. *Advt. page 253.*  
 Macdonald & Co. Ltd., Halifax, N.S. *Advt. page 256.*

**1369—FAUCETS—Self-Measuring, Petrole-  
um, Whey, Iron, Wooden.**

Smart Mfg Co. (James), Brockville, Ont. *Advt. 178.*  
 Ives, H. R. & Co., Montreal, Que. *Advt. page 200.*

**1370—FEEDERS—Bee.**

Goold, Shoply & Muir Co., Brantford, Ont.  
*Advt. page 191.*

Russell, W. G., Millbrook, Ont.

**1371—FEEDERS—Boiler.**

Robb Engineering Co. Ltd., Amherst, N. S.  
*See inside front cover.*

**1372—FEEDERS—Ore.**

Jenckes Machine Co., Sherbrooke, Que. *Advt. p. 165.*

**1373—FEEDERS—(Grain), Self.**

Sawyer & Massey Co. Ltd., Hamilton, Ont.

**1374—FEEDS—Automatic Shake (Grist Mill).**

Goldie & McCulloch Co. Ltd., Galt, Ont. *Advt. 159.*

**1375—FEEDS—Steam Saw Carriage.**

Goldie & McCulloch Co. Ltd., Galt, Ont. *Advt. 159.*  
 Carrier, Laine & Co., Levis, Que. *Advt. page 150.*  
 Hamilton Mfg Co. Ltd. (Wm.), Peterboro, Ont.

**FELLOES & RIMS—Carriage Wheel, Wa-  
gon. See No. 3809.****1376—FELT—(Paper), Carpet, Building, Dry,  
Waterproof.**

Ford, J. & Co., Portneuf Station, Que. *Advt. p. 191.*  
 Miller Bros. & Co., Glen Miller, Ont. *Advt. p. 192.*  
 Montreal Paper Co. (The), Portneuf, Que. *Advt. 253.*  
 Reid, Craig & Co., Quebec, Que.

**1377—FELT—Tarred. See No. 1378.****1378—FELT—Chemical Sheeting, Refriger-  
ator, Roofing, Tarred.**

McArthur, Alex. & Co., Montreal, Que. *Advt. 224.*  
 Reed, George W., Montreal, Que. *Advt. page 237.*  
 Paterson Mfg Co. Ltd. (The), Montreal, Que.

**1379—FELT—Sock.**

Berlin Felt Boot Co., Berlin, Ont.

**1380—FELT—Paper Makers' Dryer, Paper  
Mill, Printers' Apron, Printers' Endless,  
Pulp Mill.**

Hamelin & Ayers, Lachute Mills, Que. *Advt. p. 188.*

**1381—FENCING—(Wire),—Woven.**

Page Wire Fence Co., Walkerville, Ont. *Advt. 180.*  
 Collins Mfg Co., Toronto, Ont.

**1382—FENCE—(Locked), Wire.**

Locked Wire Fence Co. Ltd. (The), Ingersoll, Ont.

**1383—FENCE—Iron, Iron Picket.**

Ives, H. R. & Co., Montreal, Que. *Advt. page 200.*  
 Carrier, Laine & Co., Levis, Que. *Advt. page 150.*  
 Dennis, R., London, Ont. *Advt. page 207.*  
 Joliette Foundry Co., Joliette, Que.

- 1384—FENCE—(Picket), Fancy Wood.**  
Rathburn Co. (The), Deseronto, Ont. *Advt. page 162.*
- 1385—FENCING—Wire.**  
Dominion Wire Mfg Co., Montreal, Que. *Advt. 176.*
- 1386—FENCING—Barb Wire, Steel.**  
Ontario Lead & Barb Wire Co., Toronto, Ont.  
*Advt. page 177.*  
Dominion Wire Mfg Co., Montreal, Que. *Advt. p. 176.*
- 1387—FENCING—Corrugated (Iron), Sheet Metal.**  
Metallic Roofing Co., Toronto, Ont. *See front fly leaf.*
- 1388—FENCING—Wire, (Safety Barb.)**  
Safety Barb Wire Co., Toronto, Ont. *Advt. page 180.*
- 1389—FENCING—Wrought Iron.**  
Dennis, R. London, Ont. *Advt. page 207.*  
Carrier, Laine & Co., Levis, Que. *Advt. page 150.*  
Young & Bro. Co. Ltd. Hamilton, Ont. *Advt. 257.*
- 1390—FENDERS—Iron, Wire.**  
Dennis, R., London, Ont. *Advt. page 207.*
- 1391—FENDERS—Brass.**  
Hamilton Brass Mfg Co., Hamilton, Ont. *Advt. 168.*  
New York Mantel Decorating Co., Montreal, Que.  
Chadwick Bros., Hamilton, Ont. *Advt. page 206.*  
Parker, J. O., Toronto, Ont. *Advt. page 253.*  
Coulter & Campbell, Toronto, Ont. *Advt. page 201.*
- 1392—FENDERS—Cork Boat, Yacht.**  
*See No. 1417.*
- 1393—FENDERS—Carriage.** *See Dashes No. 1144.*
- 1394—FERRULES—(Malleable Iron), Neck Yoke, Tool Handle, Whiffletree.**  
Burrow, Stewart & Milne, Hamilton, Ont.  
Frost, W. H., Smith's Falls, Ont.  
Kyle, P., Smith's Falls, Ont.
- 1395—FERRATIN—B. & S.**  
Parke, Davis & Co., Walkerville, Ont.
- 1395 a—FERTILIZERS.**  
Grant, J. L. & Co., Ingersoll, Ont.  
Dominion Fertilizer Co., Hamilton, Ont.  
Vasey, Thos. E., Hochelaga, Que.  
Nowell, B. & L. & Co., Montreal, Que.
- 1 96—FIBRE WARE—Indurated.**  
Eddy Co. Ltd. (The E. B.), Hull, Que.
- 1397—FIBRE—Asbestos.**  
Sclater Asbestos Mfg Co., Montreal, Que. *Advt. 172.*  
Hopper, R. T., Montreal, Que. *Advt. page 239.*
- 1398—FIGURES—Brass, Copper, Steel.**  
Pritchard & Andrews, Ottawa, Ont. *Advt. page 250.*  
Patterson & Heward, Toronto, Ont. *Advt. page 201.*  
Dawson, G. W., Montreal, Que.
- 1399—FILERS—(Emery), Saw, Band.**  
Hart Emery Wheel Co., Hamilton, Ont. *Advt. p. 166.*
- 1400—FILERS—Saw.**  
Robb Engineering Co. Ltd., Amherst, N. S.  
*See inside front cover.*

- 1401—FILES—Office.**  
Snider, Jno. B., Waterloo, Ont. *Advt. page 231.*  
Ives, H. R. & Co., Montreal, Que. *Advt. page 200.*  
Office Specialty Mfg Co., Toronto, Ont.
- 1402—FILES—Bastard, Bone, Brush, Brass-work, Flat, Hame Makers', Iron Work, Round, Saw, Square, Woodwork.**  
Globe File Mfg Co., Port Hope, Ont. *Advt. p. 218.*  
Beaver File Works Co., Levis, Que. *Advt. page 241.*  
Phoenix File Works, Cote St. Paul, Que. *Advt. 255.*  
Ostler, Frank, Hamilton, Ont.  
Beech File Works, Hamilton, Ont.
- 1403—FILES—Auger, Axle, Jewelers', Mowing Machines, Stub, Veterinary.**  
Phoenix File Works, Cote St. Paul, Que. *Advt. 255.*  
Globe File Mfg Co., Port Hope, Ont. *Advt. p. 218.*  
Beaver File Works Co., Levis, Que. *Advt. page 241.*
- 1404—FILLERS—Egg Case, (Paper).**  
Gilmour & Co., Trenton, Ont.  
Northumberland Paper & Egg Case Co., Campbellford, Ont.  
Brown, D. F. & Co., St. John, N.B.
- 1405—FILLERS—Can, Lamp, Oil Can.**  
Davidson Mfg Co. (Thomas), Montreal. *Advt. p. 225.*  
Piper, Noah L. & Son, Toronto, Ont.  
Brown, Boggs & Co., Hamilton, Ont. *Advt. page 193.*
- 1406—FILLING—Rubber Pulley.**  
Gutta Percha & Rubber Mfg Co. Ltd., Toronto, Ont.  
*See back cover.*
- 1407—FILTERS—Water, (Household).**  
Morrison Jas. Brass Mfg Co., Toronto, Ont. *Advt. 157.*  
Garth & Co., Montreal, Que. *Advt. page 154.*  
Reed, George W., Montreal, Que. *Advt. page 237.*  
Piper, Noah L. & Son, Toronto, Ont.  
Chadwick Bros., Hamilton, Ont. *Advt. page 206.*
- 1408—FILTERS—Stone.**  
Brantford Stoneware Mfg Co., Brantford, Ont.  
*Advt. page 251.*  
Hart Bros. & Lazier, Belleville, Ont. *Advt. page 230.*  
Farrar, E. L., Iberville, Que.  
Glass Bros. & Co., London, Ont.
- 1409—FINGERS—Cradle.**  
Strathroy Mfg Co. Ltd. (The), Strathroy, Ont.
- 1410—FINIALS—Terra Cotta.**  
Beamsville Pressed Brick Co., Beamsville, Ont.  
*Advt. page 215.*  
Taylor Bros., Toronto, Ont.
- 1411—FINIALS—Wood.**  
Edwards, W. C. & Co., Ltd., Ottawa, Ont. *Advt. 219.*
- 1412—FINIALS—Iron.**  
Ives, H. R. & Co., Montreal, Que. *Advt. page 200.*  
Dennis, R., London, Ont. *Advt. page 207.*
- 1413—FINISH—Potato Bug.**  
Alabastine Co. Ltd. (The), Paris, Ont. *Advt. p. 212.*
- 1414—FIRKINS—Butter.**  
Biette & Co., Chesley, Ont. *Advt. page 240.*
- 1415—FISH—Cod, (Boneless).**  
Robertson, E. M. Co., St. John, N.B.

Parker, Eakins & Co., Yarmouth, N.S.  
Stewart, Munn & Co., Montreal, Que.  
Leonard Bros. St. John, N.B.  
Boutilier & Morehouse, Centerville, N.S.  
Eisenhauer, James & Co., Lunenburg, N.S.  
Zwicker, W. W., Lunenburg, N.S.  
Syda & Cozens, Digby, N.S.  
Crosby, L. G., Yarmouth, N. S.  
Locke, J. & V., Lockport, N.S.  
Ingraham, J. W., North Sydney, N. S.  
Acker, R., Shelburn, N.S.

**1416—FISH—(Dried), Cod, Haddock, Hakes, Herring, Finnan Haddie, Bloters.**

Halifax Fish Drier Co., Halifax, N. S.  
Moore & Robertson, North Sidney, C.B.  
Parker, Eakins & Co., Yarmouth, N.S.

**1417—FLAGS—Yacht, National.**

Soper, R., Hamilton, Ont. *Advt. page 229.*  
Pike, D., Toronto, Ont. *Advt. page 182.*  
Montreal Tent, Awning & Tarpaulin Co., Montreal, Que. *Advt. page 232.*  
Sonne Thomas, Montreal, Que.

**1418—FLANGES—Iron (Plumbers') See No. 2630**

**1419—FLANGES—Rubber.**

Gutta Percha & Rubber Mfg Co. Ltd., Toronto, Ont.  
*See back cover.*

**1420—FLANNELS—(Custom Mill), Blue, Gray, White.**

Hepworth, James R., Lancaster, Ont.  
Berry, M. B., Quebec, Que.  
Hamelin & Ayers, Lachute Mills, Que. *Advt. p. 188.*  
McKay Woolen Co., Charlottetown, P.E.I.  
Taylor, T. H. Co. Ltd., Chatham, Ont. *Advt. p. 236.*  
Waterhouse, Thomas, Palmerston, Ont.  
Hodge, William, Cornwall, Ont.  
Sills Bros., Frankford, Ont.  
Humphrey, John A. & Son, Moncton, N.B.  
Grindrod, A. L. & Co., Sherbrooke, Que.  
Elmsdale Flannel Mills, Almonte, Ont.  
Markham Woolen Mill Co., Markham, Ont.  
Gilmore Woolen Mills (The), Joliette, Que.

**1421—FLANNELS—Dress, Fancy, Fine, Flannels.**

Lomas, Adam & Son, Sherbrooke, Que.  
Thoburn, William, Almonte, Ont.  
Trent Valley Woolen Mfg Co., Campbellford, Ont.  
Brodie & Co., Hespeler, Ont.  
Humphrey, John A. & Son, Moncton, N. B.  
Waterloo Woolen Co. Ltd., Waterloo, Ont.  
Granite Mills, St. Hyacinthe, Que.  
Hamelin & Ayers, Lachute Mills, Que.

**1422—FLASHINGS—(Metal), Roof. See No. 2856.**

**1423—FLASKS—Powder, (Tin).**

Davidson Mfg Co. (Thos.), Montreal, Que. *Advt. 225.*

**1424—FLATTERS—(Blacksmiths).**

Whitman & Barnes Mfg Co., St. Catharines, Ont.

**1425—FLAT WARE—Plated.**

Ontario Silver Co., Humbertstone, Ont.  
Simpson, Hall, Miller & Co., Montreal, Que.  
*Advt. page 203.*  
Standard Silver Co., Toronto, Ont.

**1426—FLAX—Hackled, Scutched.**

Livingston, J. & J., Baden, Ont.  
Weir & Weir, St. Mary's Ont.

**1427—FLAX—Upholsterer.**

Forrester, Andrew, Mitchell, Ont.  
Hartleib & Lindenfeldt, Dashwood, Ont.  
Gunn & Murray, Strathroy, Ont.  
Clark & Carman, St. Mary's, Ont.

**1428—FLIGHTS—Conveyer.**

Miller Bros. & Toms, Montreal, Que. *Advt. p. 197.*  
Kerr & Morgan, Montreal, Que. *Advt. page 220.*

**1429—FLOATS—Cork, Fish Line & Net.**

Cork Co. of Canada Ltd., Toronto, Ont. *Advt. p. 187.*

**1430—FLOATS—Water Closet.**

Chadwick Bros., Hamilton, Ont. *Advt. page 206.*

**1431—FIREWORKS.**

Hand & Co., Hamilton, Ont.

**1432—FLOCK—Cotton. See Waste No. 3705.**

**1433—FLOORS—Perforated Metal Kiln. See No. 2856.**

**1434—FLOORING—(Steel), Fireproof.**

Central Bridge & Engineering Co. Ltd., Peterboro, Ont. *Advt. page 214.*

**1435—FLOORS—Slate.**

New Rockland Slate Co., Montreal, Que. *Advt. 244.*  
Danville Asbestos & Slate Co., Danville, Que.

**1436—FLOORING—(Matched), Hard, Soft Wood, Parquet, Wainscoting, Decking, Car, House, Building.**

Atkinson, Henry, Etchemin, Que. *Advt. page 222.*  
Edwards, W. C. & Co., Ottawa, Ont. *Advt. p. 219.*  
Gravel, A. Lumber Co., Etchemin, Que. *Advt. 215.*  
Pembroke Lumber Co. Pembroke, Ont. *Advt. p. 216.*  
Copping, Wm., Joliette, Que.  
Rhodes, Curry & Co., Amherst, N. S. *Advt. p. 158.*  
Rathbun (The) Co., Deseronto, Ont. *Advt. p. 162.*  
Gilmore & Co., Trenton, Ont.  
Montreal Terra Cotta & Lumber Co., Montreal, Que. *Advt. page 214.*

Hawkesbury Lumber Co., Hawkesbury, Ont.

**1437—FLOORING—Hard Wood. See No. 1436.**

**1438—FLOORING—Rubber. See No. 2170.**

**1439—FLOUR—Family, Strong Bakers', Graham, Manitoba, Patent, Pastry, High Grade, Chop. (Wheat Grits, Mill Feeds, Ground Feed).**

Goldie, James, Guelph, Ont. *Advt. page 238.*  
Harper, Geo. H., Dundas, Ont.  
Goldie Milling Co., Ayr, Ont. *Advt. page 238.*  
Meldrum & McAllister, Peterborough, Ont. *Advt. 258.*  
Wylie, James W., Almonte, Ont. *Advt. page 203.*  
Martin & Warnock, Ottawa, Ont.  
Sadler, Dundas & Flavell Milling Co., Lindsay, Ont.  
Taylor, T. H. & Co., Ltd., Chatham, Ont. *Advt. 236.*  
Rathbun (The) Co., Deseronto, Ont. *Advt. p. 162.*  
Whitlaw, Baird & Co., Paris, Ont. *Advt. page 236.*  
Tilson, E. D., Milling Co., Tilsonburg, Ont.  
MacFarlane Milling Co., Sherbrooke, Que.  
Lazier, S. A., Belleville, Ont.

Seagram, Jos. E., Waterloo, Ont.  
 Wilson, J. C., Glenora, Ont.  
 McCarger, P. G., Peterborough, Ont. *Advt. page 254.*  
 Smith, Chas. & Sons, Campbellford, Ont.  
 McKay Milling Co., Ottawa, Ont.  
 Shirk & Snider, Bridgeport, Ont.  
 Snider, William & Co., Waterloo, Ont.  
 Kribs, Lewis, Hespeler, Ont.  
 Saunby, J. D., London, Ont.  
 Baldwin, George S., Aurora, Ont.  
 Leitch Bros., Oak Lake, Man.  
 Lingham, W. L., Belleville, Ont.  
 Wenger, N. & Bros., Ayton, Ont.  
 The New Glasgow Milling Co., New Glasgow, N.S.

**1440—FLOUR—"Special Brands".**

**Juno, Crown Jewel, Rathbun's Best, White Lily.**

Rathbun Co. (The), Deseronto, Ont. *Advt. p. 162.*

**do —Ayshire Rose, Gilt Edge, People's, Goldie's Best, Chancellor.**

Goldie, James, Guelph, Ont. *Advt. page 238.*

**do —Eclipse.**

Wyle, James W., Almont, Ont. *Advt. page 203.*

**do —Goldie's Star, Crown of Gold, Crescent, Lincoln.**

Goldie (The) Milling Co., Ayr, Ont. *Advt. page 238.*

**do —Delight, Five Thistles, Gladioli, Mikado, Pure Cream, Silver Leaf.**

Meldram & McAllister, Peterboro, Ont. *Advt. p. 258.*

**do —Samson, Morning Star.**

McCargar, P. G., Peterboro, Ont. *Advt. page 254.*

**do —Hecuba, Our Glory.**

McFarlane (The) Milling Co., Sherbrooke, Que.

**do —Magyur, The Star, Bridal Rose.**

Whitlaw, Baird & Co., Paris, Ont. *Advt. page 236.*

**do —Seal, Famous, Beaver.**

Taylor, T. H. & Co., Chatham, Ont. *Advt. page 236.*

**1441—FLUES—Chimney.**

Beamsville Pressed Brick Co., Beamsville, Ont. *Advt. page 215.*

Glass Bros. & Co., London, Ont.

**1442—FLUMES—Water, (Iron & Steel).**

Patterson, John, Halifax, N.S. *Advt. page 194.*

Wilson, J. C. & Co., Glenora, Ont.

**1443—FLUTERS—Laundry.**

Smart (James) Mfg Co., Brockville, Ont.

**1444—FOBS—Gold & Silver. See No. 757.**

**1445—FOIL—(Tin) Bottle.**

Canada Cork Cutting Co., Montreal, Que. *Advt. 223.*  
 Harris, C. C., Toronto, Ont.

**1446—FOIL—Gold.**

Hubbard, C. H., Toronto, Ont.

**1447—FOLDERS—Bread Pan, Sheet Iron, Square Box, Tin. See No. 2630.**

**1448—FOLIOS—Music, Blank.**

Whaley, Royce Piano Co., Toronto, Ont. *Advt. 189.*  
 Brown Bros. Ltd. (The), Toronto, Ont.  
 Morton, Phillips & Co., Montreal, Que.

**1449—FOOD—(Medicinal), Cattle, Horse, Poultry.**

Stearns, Fred'k & Co., Windsor, Ont. *See back cover.*

**1450—FOODS—Infant, Invalid.**

Johnston Fluid Beef Co., Montreal, Que. *Advt. p. 235.*  
 Lyman, Sons & Co., Montreal, Que.  
 Kerry, Watson & Co., Montreal, Que.

**1451—FORGES—Portable.**

Robb Engineering Co. Ltd., Amherst, N. S. *See inside front cover.*  
 Thompson, Joseph, St. John, N. B.

**1452—FORGINGS—Carriage.**

Gillies, Geo. Co., Gananoque, Ont. *Advt. page 156.*  
 Swansea Forging Co. Ltd., Swansea, Ont. *Advt. 156.*

**1453—FORGINGS—Brass.**

Hamilton Brass Mfg Co., Hamilton, Ont. *Advt. 168.*  
 Morrison Mfg Co. (Jas.), Toronto, Ont. *Advt. p. 157.*  
 Macdonald & Co. Ltd., Halifax, N. S. *Advt. 256.*  
 Mitchell, Rob't & Co., Montreal, Que. *Advt. p. 213.*

**1454—FORGINGS—(Drop) Copper, Iron, Steel.**

*See No. 1452.*

**1455—FORGINGS—Steel Bicycle.**

Gillies, Geo. (The Co.), Gananoque, Ont. *Advt. 156.*  
 Morrow, John, (The), Machine Screw Co. *Advt. 260.*  
 Nova Scotia Steel Co. Ltd. New Glasgow, N.S.

**1456—FORGINGS—Car, Heavy, Locomotive, Railway, Special, Wrought Iron, Lock.**

Canadian Locomotive & Engine Co. Ltd., Kingston, Ont. *Advt. page 175.*

Gillies, Geo. (The Co.), Gananoque, Ont. *Advt. 156.*  
 Carrier, Laine & Co., Levis, Que. *Advt. page 150.*  
 Stewart, John, New Glasgow, N.S. *Advt. page 222.*  
 Rodden, Wm. & Co., Montreal, Que.  
 Canada Spring & Switch Co. Ltd., Montreal, Que. *Advt. page 217.*

Dominion Bridge Co. Ltd., Montreal, Que. *Advt. 195.*  
 Brown, (G. & J.) Mfg Co., Belleville, Ont. *Advt. 198.*  
 Central Bridge & Engineering Co. Ltd., Peterborough, Ont. *Advt. page 214.*  
 Nova Scotia Steel Co. Ltd., New Glasgow, N.S.

Loignon, A. & E., Montreal, Que. *Advt. page 247.*  
 Crossen Car Mfg Co. Ltd., Cobourg, Ont. *Advt. 160.*  
 Rhodes, Curry & Co. Ltd., Amherst, N.S. *Advt. 158.*  
 Rathbun Co. (The), Deseronto, Ont. *Advt. page 162.*

**1457—FORKS—Sterling Silver. See No. 3092.**

**1458—FORKS—Table, Silver Plated & Pickle Wire. See No. 3092.**

**1459—FORKS—Hay, (Double Harpon).**

*See No. 3128.*

**1460—FORKS—(Steel), Barley, Farm, Hay, Manure, Potato, Spading, Vegetable.**

*See No. 2742.*

**1461—FORMS—Blank Note, Blank Receipt.**

*See No. 384.*

**1462—FORMS—(Display), Wire Dress, Coat, Dummy.**

Meadows, George B., Toronto, Ont.

**1463—FORMERS—(Machine), Corrugating, Eavetrough, Stovepipe, Nickle, Table, Wire Ring.** See No. 2125.

**1464—FOUNDATIONS—Honey Comb.**

Goold, Shapley & Muir Co., Brantford, Ont.

Phillips, T. & Co., Orillia, Ont. *Advt. page 191.*  
Russell, W. G., Millbrook, Ont. *Advt. page 259.*

**1465—FOUNTAINS—Soda Water.**

Garth & Co., Montreal, Que. *Advt. page 154.*  
Parker, J. O., & Co., Toronto, Ont. *Advt. page 253.*  
Fletcher Mfg Co., Toronto, Ont.

**1466—FOUNTAINS—(Iron) Drinking.**

Central Bridge & Engineering Co. Ltd., Peterboro, Ont. *Advt. page 214.*  
Nichols, Thos. E., Hamilton, Ont.

**1467—FOUNTS—Glass Lamp.**

Lamont Glass Co., New Glasgow, N. S. *Advt. p. 231.*

**1468—FRAMES—(Wood) Photograph, Picture, Advertising.**

Woltz & McMahon, Toronto, Ont. *Advt. page 203.*  
Cobban Mfg Co., Ltd., Toronto, Ont.  
Matthews Bros. & Co., Toronto, Ont.

**1469—FRAMES—Bonnet & Hat.** See No. 1683.

**1470—FRAMES—Furniture.**

Ellis Furniture Co. (The), Ingersoll, Ont. *Advt. 208.*  
Hibner, D. & Co., Berlin, Ont.  
Rousseau, J. A., Ste. Anne de la Parade, Que.  
Lippert, Schaefer & Co., Waterloo, Ont.  
Krug, H., Berlin, Ont.

**1471—FRAMES—Grindstone.**

Bertram, John & Sons, Dundas, Ont. *Advt. page 161.*  
Smart Mfg Co. (James), Brockville, Ont. *Advt. 178.*

**1472—FRAMES—Cast Register.**

Carrier, Laine & Co., Levis, Que. *Advt. page 150.*  
Gurney, Tilden Co. Ltd., Hamilton, Ont. *Advt. 151.*  
Smart Mfg Co. (James), Brockville, Ont. *Advt. 178.*

**1473—FRAMES—Door & Window.**

Edwards, W. C. & Co. Ltd., Ottawa, Ont. *Advt. 219.*  
Rhodes, Curry & Co., Amherst, N.S. *Advt. page 158.*  
Rathbun Co. (The), Deseronto, Ont. *Advt. page 162.*

**1474—FRAMES—(Iron), Ventilator.**

Dennis, R., London, Ont. *Advt. page 207.*

**1475—FRAMES—Numeral.**

Gage Co. Ltd. (W. J.), Toronto, Ont. *Advt. p. 189.*

**1476—FRAMES—Ship Stern.**

Nova Scotia Steel Co. Ltd., New Glasgow, N.S.

**1477—FRAMES—Lounge.**

Thompson, Alex. & Co., Hamilton, Ont.

**1478—FRAMES—Slate Register.**

New Rockland Slate Co., Montreal, Que. *Advt. 244.*  
Burns & Co., Halifax, N.S.

**1479—FRAMES—Buck Saw.**

Parker & Howe, Dixville, Que.  
Wesley, F. J. & Co., Toronto Junction, Ont.

**1480—FRAMES—Band Saw Brazing.**

Bertram, John & Sons, Dundas, Ont. *Advt. p. 161.*

**1481—FRAMES—Locomotive, (Iron).**

Canadian Locomotive Co., Kingston, Ont. *Advt. 175.*  
Rathbun Co. (The), Deseronto, Ont. *Advt. page 162.*

**1482—FRAMES—Awning.** See No. 67.

**1483—FRAMES—Street Lamp, Iron.**

Ives, H. R. & Co., Montreal, Que. *Advt. page 200.*  
Garth & Co., Montreal, Que. *Advt. page 154.*

**1484—FRAMES—Iron & Steel, Building.**

Stewart, John, New Glasgow, N.S. *Advt. page 222.*  
Central Bridge & Engineering Co., Peterborough, Ont. *Advt. page 214.*  
Dominion Bridge Co. Ltd. Montreal, Que. *Advt. 195.*

**1485—FREIZES—Plaster Composition.**

McCausland, Jos. & Son, Toronto, Ont.

**1486—FREIZES—Relief.**

Elliott & Sons, Toronto, Ont.

**1487—FRET WORK—(Moorish).**

Otterville Mfg Co. Ltd., Otterville, Ont. *Advt. 259.*

**1488—FRET WORK—Oak, Window, White & Enamelled Gold.**

Gendron, Mfg Co., Toronto, Ont. *Advt. page 187.*  
Thompson, Alex. & Co., Hamilton, Ont.

**1489—FREEZERS—Ice Cream.**

Davidson Mfg Co. (Thos.), Montreal, Que. *Advt. 225.*  
Smart Mfg Co., (Jas.), Brockville, Ont. *Advt. p. 178.*

**1490—FROES—Coopers'.**

Gardner, Tool Co. (W. R.), Brockville, Ont.  
Broad, E. Sons & Co., St. Stephen, N. B.

**1491—FROGS—"Patent Clamp".**

Canada Spring & Switch Co. Ltd., Montreal. Que. *Advt. page 217.*

**1492—FROGS—Railway Track, Switch.**

Stewart, John, New Glasgow, N. S. *Advt. p. 222.*  
Canada Spring & Switch Co. Ltd., Montreal, Que. *Advt. page 217.*

Brown, (G. & J.) Mfg Co., Belleville, Ont. *Advt. 198.*  
Ingersoll Rock Drill Co., Montreal, Que. *Advt. 198.*

**1493—FRONTS—Metallic Building.** See No. 2865.

**1494—FRONTS—(Leather), Bridle.**

Dowell, D., Montreal, Que. *Advt. page 203.*

**1495—FRONTS—(Brass), Bridle.**

Chadwick Bros., Hamilton, Ont. *Advt. page 206.*

**1496—FRONTS—(Iron), Building, Store.**

Gurney, Tilden Co. Ltd., Hamilton, Ont. *Advt. 151.*  
Garth & Co., Montreal, Que. *Advt. page 154.*  
Carrier, Laine & Co., Levis, Que. *Advt. page 150.*  
Fleck, Alex. Jr., Ottawa, Ont. *Advt. page 252.*  
Dominion Bridge Co. Ltd., Montreal, Que. *Advt. 195.*  
Parker, Moses, Montreal, Que. *Advt. page 197.*

**1497—FRONTS—Bakcrs' Oven, Boiler, Boiler Fire, Iron Grate.**

Carrier, Laine & Co., Levis, Que. *Advt. page 150.*  
Jenckes Machine Co., Sherbrooke, Que. *Advt. 165.*



- Goldie & McCulloch Co. Ltd., Galt, Ont. *Advt.* 159.  
 Rodden, Wm. & Co., Montreal, Que.  
 Babcock & Wilcox Co., Montreal, Que. *Advt.* 194.  
 Brush, Geo., Montreal, Que.  
 Fleck, Alex., Jr., Ottawa, Ont. *Advt. page* 252.
- 1498—FUNNELS—Rubber.**  
 Canadian Rubber Co., Montreal, Que. *Advt. p.* 197.
- 1499—FUNNELS—Glass.**  
 Dominion Glass Works, Montreal, Que. *Advt.* 221.
- 1500—FUNNELS—Ships.**  
 Carrier, Laine & Co., Levis, Que. *Advt. page* 150.  
 Patterson, John, Halifax, N. S. *Advt. page* 194.  
 Mathison, I. & Co., New Glasgow, N. S. *Advt.* 200.
- 1501—FUNNELS—Copper.**  
 American Copper Co., Toronto, Ont. *Advt. p.* 157.  
 Booth Copper Co., Toronto, Ont. *Advt. page* 155.  
 Garth & Co., Montreal, Que. *Advt. page* 154.  
 Coulter & Campbell, Toronto, Ont. *Advt. page* 201.  
 Chadwick Bros., Hamilton, Ont. *Advt. page* 206.  
 Parker, J. O. & Co., Toronto, Ont. *Advt. page* 253.
- 1502—FURNACES—(Boiler Plate), Blast, Ore Smelting, Revolving Roasting.**  
 Jenckes Machine Co., Sherbrooke, Que. *Advt. p.* 165.  
 Fleck, Alex. Jr., Ottawa, Ont. *Advt. page* 252.
- 1503—FURNACES—“Perfect” (Air Tight), “Harris” (Wood), “Monarch” Coal.**  
 Gurney, Tilden Co. Ltd., Hamilton, Ont. *Advt.* 151.
- 1504—FURNACES—Hot Air (Cumberland).**  
 Crossman & Laws, Amherst, N. S. *Advt. page* 226.
- 1505—FURNACES—(Cast Iron), Heating, Hot Air.**  
 Gurney, Tilden Co. Ltd., Hamilton, Ont. *Advt.* 151.  
 Ives, H. R. & Co., Montreal, Que. *Advt. page* 200.  
 Gurney Foundry Co. Ltd., Toronto, Ont.  
 Carrier, Laine & Co., Levis, Que. *Advt. page* 150.  
 Stewart Mfg Co. Ltd. (Jas.), Woodstock, Ont.  
 Robb Engineering Co. Ltd., Amherst, N.S.  
*See inside front cover.*  
 Clare Bros. & Co., Preston, Ont. *Advt. page* 243.  
 King, Warden & Son, Montreal, Que.  
 McDougall, R. & Co., Galt, Ont. *Advt. page* 199.  
 Star Iron Co., Montreal, Que.  
 Bigley, R., Toronto, Ont. *Advt. page* 242.  
 Crossman & Laws, Amherst, N.S. *Advt. page* 226.  
 Smart (James) Mfg Co., Brockville, Ont. *Advt.* 178.
- 1506—FURNITURE.**  
 The Knetchtel Furniture Co., Hanover, Ont.  
 Button & Fessent, Teeswater, Ont. *Advt. page* 251.  
 Gibbard Furniture Co. Ltd., Napanee, Ont.  
 Alexandria Mfg Co. Ltd., Alexandria, Ont.  
 Zoellner, E. F. R., Mount Forest, Ont.  
 Siemon & Hill, Warton, Ont.  
 Krug Bros. & Co., Chesley, Ont.  
 Mundell, John & Co., Elora, Ont.  
 Anthes Mfg Co. Ltd. (The), Berlin, Ont.  
 Beach, M. F. & Co., Winchester, Ont.  
 Bell, Thomas, Wingham, Ont.  
 Broadfoot & Box Furniture Co., Seaforth, Ont.  
 Hahn, Lewis, New Hamburg, Ont.  
 Simpson Furniture Co., Berlin, Ont.  
 Tickle, G. S. & Sons, Belleville, Ont.  
 Vallière, P., Quebec, Que.

- Anderson Furniture Co., Woodstock, Ont.  
 London Furniture Co., London, Ont.
- 1507—FUR GOODS.**  
 Paquet, Z., Quebec, Que.  
 Laliberte, J. B., Quebec, Que.  
 Gnadedinger, L. Son & Co., Montreal, Que.  
 Coristine, James & Co., Montreal, Que.  
 Greene & Sons Co., Montreal, Que.  
 Levin, B. & Co., Montreal, Que.  
 Silverman, Bolter & Co., Montreal, Que.  
 Glassco, G. F. & Co., Hamilton, Ont.  
 Brereton & Manning, Toronto, Ont.  
 Magee's, D. Sons., St. John, N. B.  
 Cormier, Z. P., Sherbrooke, Que.  
 Devlin, R. J., Ottawa, Ont.  
 Allen, A. A. & Co., Toronto, Ont.  
 Marshall, George & Co., London, Ont.  
 Everett, C. & E., St. John, N. B.  
 Gillespie, Ansley & Dixon, Toronto, Ont.
- 1508—FURNITURE—Altar, Bank & Office, Church, Hall, Library, Lodge Room, Public School, Sunday School,**  
 Canadian Office & School Furniture Co, Ltd. (The),  
 Preston, Ont. *Advt. page* 210.  
 Globe Furniture Co., Walkerville, Ont. *Advt. p.* 225.  
 Tees & Co., Montreal, Que. *Advt. page* 225.  
 Snider, John B., Waterloo, Ont. *Advt. page* 231.  
 Ellis Furniture Co., Ingersoll, Ont. *Advt. page* 208.  
 New York Mantel Decorating Co., Montreal, Que.  
 Rhodes, Curry & Co., Amherst, N. S. *Advt. p.* 158.
- 1509—FURNITURE—Court House, Public Building, Theatre, Society. See No. 1508.**
- 1510—FURNITURE—Store, (Iron).**  
 Smart, (Jas.) Mfg Co., Brockville, Ont. *Advt. p.* 178.
- 1511—FURNITURE—Bamboo Toy.**  
 Gendron Mfg Co. Ltd., Toronto, Ont. *Advt. p.* 187.  
 Thompson, A. & Co., Hamilton, Ont.
- 1512—FURRING—Terra Cotta.**  
 Rathbun Co. (The), Deseronto, Ont. *Advt. page* 162.
- 1513—FUSE—Blasting, Electric, Platinum, Safety, Waterproof, Fuse & Connecting Wires.**  
 Hamilton Powder Co., Montreal, Que. *Advt. p.* 196.  
 Acadia Powder Co. Ltd., Halifax, N. S. *Advt. p.* 240.
- 1514—GALLEYS—Printers'.**  
 Westman & Baker, Toronto, Ont.  
 Dominion Type Foundry, Montreal, Que.
- 1515—GALLEYS—(Brass), Printers'.**  
 Chadwick Bros., Hamilton, Ont. *Advt. page* 206.
- 1516—GALVANOMETERS.**  
 Toronto Electrical Works, Toronto, Ont.  
 Canadian General Electric Co. Ltd., Toronto, Ont.  
 Bell Telephone Co. (The), Montreal, Que.
- 1517—GAMES—(Wood), Parlor.**  
 Goulette, O. V., Gananoque, Ont. *Advt. page* 214.  
 Tees & Co., Montreal, Que. *Advt. page* 225.
- 1518—GARTERS—Elastic.**  
 Stouffer, J. R. Co. Ltd., Berlin, Ont. *Advt. p.* 185.  
 Globe Suspender Co., Rock Island, Que.

**1519—GASFIRE—Fire Clay, (Fire Place).**

Campbell, R., Hamilton, Ont. *Advt. page 230.*

**1520—GASKETS—Asbestos.**

Slater Asbestos, Mfg Co., Montreal, Que. *Advt. 172.*

**1521—GASKETS—Fibrous Rubber.**

Gutta Percha & Rubber Mfg Co. Ltd., Toronto, Ont.  
*See back cover.*

Canadian Rubber Co., Montreal, Que. *Advt. p. 197.*

**1522—GASKETS—Copper, Lead.**

McAvity, T. & Son, St. John, N. B. *Advt. page 153.*  
Coulter & Campbell, Toronto, Ont. *Advt. page 201.*  
Morrison, Jas. Brass Mfg Co., Toronto, Ont.  
*Advt. page 157.*

**1523—GASOLINE.**

Imperial Oil Co. Ltd., Petrolia, Ont. *Advt. page 230.*

**1524—GATES—(Iron), Creamer, Oil.**

Smart, (Jas.) Mfg Co., Brockville, Ont. *Advt. p. 178.*

**1525—GATES—Cantilever, (Wood).**

Pembroke Foundry, Pembroke, Ont.

**1526—GATES—(Wood), Automatic, Crossing, Farm.**

Smith & Henderson, Blenheim, Ont.  
Munro Bros., New Glasgow, N.S. *Advt. page 244.*

**1527—GATES—Molasses Measuring, Self Boring.**

Ives, H. R. & Co., Montreal, Que. *Advt. page 200.*  
Smart (Jas.) Mfg Co., Brockville, Ont. *Advt. p. 178.*  
Morrison (Jas.) Brass Mfg Co., Toronto, Ont.  
*Advt. page 157.*  
Parker, J. O. & Co., Toronto, Ont. *Advt. page 253.*

**1528—GATES—(Iron), Elevator, Cemetery.**

Dennis, R., London, Ont. *Advt. page 207.*  
Toronto Fence & Iron Works, Toronto, Ont.  
Fensom, John, Toronto, Ont.  
Garth & Co., Montreal, Que. *Advt. page 154.*  
Munro Bros., New Glasgow, N.S. *Advt. page 244.*  
Carrier, Laine & Co., Levis, Que. *Advt. page 150.*  
Robb Engineering Co. Ltd., Amherst, N. S.  
*See inside front cover.*  
McAvity, T. & Sons, St. John, N.B. *Advt. p. 153.*  
Myers, W. F. & J. W., St. John, N.B. *Advt. p. 163.*

**1529—GATES—Iron, Water Works.**

Garth & Co., Montreal, Que. *Advt. page 154.*  
Carrier, Laine & Co., Levis, Que. *Advt. page 150.*  
Fleck, Alex. Jr., Ottawa, Ont. *Advt. page 252.*  
Kerr Engine Co., Walkerville, Ont. *Advt. p. 208.*  
Matheson, I. & Co., New Glasgow, N. S. *Advt. 200.*

**1530—GATES—Cheese Vat.**

Ives, H. R. & Co., Montreal, Que. *Advt. page 200.*

**1531—GATES—(Wire) Fence, Railway, Woven Wire.**

Buchanan, M. T., Ingersoll, Ont.  
Page Wire Fence Co., Walkerville, Ont. *Advt. p. 180.*  
Munro Bros., New Glasgow, N. S. *Advt. page 244.*  
Locked Wire Fence Co. (The), Ingersoll, Ont.

**1532—GAUGES—Indicating, Locomotive, Vacuum, Steam, Pressure, Back Pressure, Combination.**

Garth & Co., Montreal, Que. *Advt. page 154.*

McAvity, T. & Sons, St. John, N. B. *Advt. page 153.*  
Mitchell, Rob't & Co., Montreal, Que. *Advt. p. 213.*  
Robb Engineering Co., Ltd., Amherst, N. S.

*See inside front cover.*

Kerr Engine Co., Walkerville, Ont. *Advt. 208.*  
Morrison, Jas. Brass Mfg Co., Toronto, Ont. *Advt. 157.*  
Parker, J. O. & Co. Toronto, Ont., *Advt. page 253.*

**1533—GAUGES—Cream.**

Lancaster Machine Works, Lancaster, Ont. *Advt. 248.*

**1534—GAUGES—Track.**

Brown (G. & J.) Mfg Co., Belleville, Ont. *Advt. 198.*

**1535—GAUGES—Saw.**

Carrier, Laine & Co., Levis, Que. *Advt. page 150.*  
Robb Engineering Co. Ltd., Amherst, N.S.  
*See inside front cover.*

**1536—GAUGES—Automatic Water, Water.**

Garth & Co., Montreal, Que. *Advt. page 154.*  
Pemberthy Injector Co., Windsor, Ont. *Advt. 164.*  
Mitchell, Robt. & Co., Montreal, Que. *Advt. 213.*  
Morrison James Brass Mfg Co., Toronto, Ont.  
*Advt. page 157.*

Macdonald & Co. Ltd., Halifax, N.S. *Advt. p. 256.*  
McAvity, T. & Sons, St. John, N.B. *Advt. p. 153.*  
Parker, J. O. & Co., Toronto, Ont. *Advt. page 253.*

**1537—GAUNTLETS—Men's Fur, Ladies' Fur.**

*See No. 1507.*

**1538—GEARING—Machine Cut.**

Ballantine, John & Co., Preston, Ont. *Advt. p. 205.*  
Fraser Bros., New Glasgow, N.S. *Advt. page 252.*

**1539—GEARINGS—Agricultural Machinery.**

Moody, Matthew & Sons, Terrebonne, Que. *Advt. 209.*  
Gowdy Mfg Co., Guelph, Ont.

**1540—GEARING—Bevel, Friction, Shrouded, Mitre, Spur.**

*See Gears No. 1544.*

**1541—GEARS—(Iron), Richardson's Improved Steering.**

Myers, W. F. & J. W., St. John, N.B. *Advt. p. 163.*

**1542—GEARS—Crane, (Cheese Factory).**

McOuat & McRac, Lachute, Que. *Advt. page 205.*

**1543—GEARS—Omnibus, Truck, Wagon.**

Laurie Engine Co., Montreal, Que. *See page 179.*  
Miner Carriage Mfg Co., Granby, Que.  
Wannock, James & Co., Galt, Ont.  
Cowan, O. D., Gananoque, Ont. *See page 233.*

**1544—GEARS—(Cast Iron), Mortise, Worm, Hoisting.**

Bertram, John & Sons, Dundas, Ont. *See page 161.*  
Laurie Engine Co., Montreal, Que. *See page 179.*  
Goldie & McCulloch Co. Ltd., Galt, Ont. *See p. 159.*  
Fraser Bros., New Glasgow, N.S. *See page 252.*  
Kerr & Morgan, Montreal, Que. *See page 220.*  
Jenkes Machine Co., Sherbrooke, Que. *See page 165.*  
Matheson, I. & Co., New Glasgow, N.S. *See page 200.*  
Brown, G. & J. Mfg Co., Belleville, Ont. *See p. 198.*  
Waring, White & Co., St. John, N.B. *See page 256.*  
Miller Bros. & Toms, Montreal, Que. *See page 197.*  
Carrier, Laine & Co., Levis, Que. *See page 150.*  
Fleck, Alex., Jr., Ottawa, Ont. *See page 252.*  
Wilson, J. C. & Co., Glenora, Ont.  
McDonald & Co. Ltd., Halifax, N.S. *See page 256.*

**1544 a—GENERATORS—Soda Water.**

Fletcher Mfg Co., Toronto, Ont.

**1545—GEARS—Carriage.**Armstrong Mfg Co. (J. B.), Guelph, Ont.  
McLaughlin Carriage Co., Oshawa, Ont.  
Miner Carriage Mfg Co., Granby, Que.**1546—GENERATORS—Electric.**

Ahearn &amp; Soper, Ottawa, Ont.

**1547—GENERATORS—Telephone.**Ness, McLaren & Bate, Montreal, Que. *See p. 240.***1548—GIGS—Ice.**

Fensom, John, Toronto, Ont.

**1549—GIGS—Ore.**Jenckes Machine Co., Sherbrooke, Que. *See p. 165.***1550—GIGGS—Cloth.**

Karch, H. W., Hespeler, Ont.

**1551—GIMPS—Furniture.**White Allan Co. Ltd. (The), Toronto, Ont.  
Moulton & Co., Montreal, Que.**1552—GIRDERS—Box, Bridge, Iron, Plate, Steel, Tee.**Dominion Bridge Co. Ltd., Montreal, Que. *See p. 195.*  
Matheson, I. & Co., New Glasgow, N.S. *See p. 200.*  
Central Bridge & Engineering Co., Peterboro, Ont.  
*See page 214.*Ives, H. R. & Co., Montreal, Que. *See page 200.*  
Carrier, Laine & Co., Levis, Que. *See page 150.*  
Brown Mfg Co. (G. & J.), Belleville, Ont. *See p. 198.*  
Stewart, John, New Glasgow, N.S. *See page 222.*  
Rodden, Wm. & Co., Montreal, Que.**1553—GIRDLES—Chenille Curtain.**Toronto, Carpet Co., Toronto, Ont. *See page 186.*  
Curtain & Upholstering Mfg Co., Guelph, Ont.**1554—GIRTHS—Saddle, Web, Leather, "Single."**Borbridge, S. & H., Ottawa, Ont.  
Morgan Bros., Hamilton, Ont.**1555—GLASS—Art, Bent, Bevelled, Cheval, Colored, Cut, Enamelled, Flint, Ground, Jewelled, Mirror, Mosaic, Ornamental, Pressed, Stained.**Hobbs Mfg Co., London, Ont. *See page 212.*  
Ramsay, A. & Son, Montreal, Que. *See page 211.*  
Elliott & Son, Toronto, Ont.  
Lyon, N. T., Toronto, Ont. *See page 221.*  
McCausland, Jos. & Son, Toronto, Ont.**1555 a—GLASS—Blown.**Lamont Glass Co., New Glasgow, N. S. *See page 231.*  
Dominion Glass Works, Montreal, Que. *See page 221.***1556—GLOBES—Electric Light, Fish, Lamp, Lantern.**Lamont Glass Co., New Glasgow, N. S. *See page 231.***1557—GLOVES—Rubber.**Canadian Rubber Co., Montreal, Que. *See page 197.***1558—GLOVES—Buckskin, Calfskin, Kid, Leather, Napa-Buck, Sheepskin, Fur Top, Lined, Unlined.**Chapman, W. J., Wingham, Ont. *See page 227.*  
Jago, W. H. & Son, Rockwood, Ont. *See page 182.*  
Storey, W. H. & Son, Acton, Ont.  
Clarke, A. R. & Co., Toronto, Ont.  
Hall, James & Co., Brockville, Ont. *See page 227.*  
Balcer, Henry M., Three Rivers, Que.**1559—FUR GLOVES & MITTS.**Canadian Manufacturer of Furs, Hair Point, Que.  
Story, W. H. & Son, Acton, Ont.  
Hall, James & Co., Brockville, Ont. *See page 227.*  
Balcer, Henry M., Three Rivers, Que.  
Clarke, A. R. & Co., Toronto, Ont.**1560—GLUE—Fish.**

Stewart, Munn &amp; Co., Montreal, Que.

**1561—GLUE—Liquid.**McCrea & Hanes, Toronto, Ont. *See page 248.***1562—GLUE—Carriage, Emery, Family, Furniture, Piano Makers', Tablet.**St. Jacob's Glue Co., St. Jacobs, Ont. *See page 229.*  
Bates Mfg Co. Halifax, N.S.  
Fox, Albert, Cote St. Paul, Que.  
Huber, J. T. & Co., Doon, Ont.  
Stuart, E. J., Montreal, Que.  
Harris, W. & Co., Toronto, Ont.**1563—GLYCERINE.**

St. Henri Chemical Co. Ltd., Montreal, Que.

**1564—GLYCERINE—Nitro.**

Ottawa Powder Co., Buckingham, Que.

**1565—GLYCEROLE—Pepsin, Yerba Comp.**

Parke, Davis &amp; Co., Walkerville, Ont.

**1566—GODDERS—For Slate & Marble.**Canadian Hand Drill Co., Sherbrooke, Que. *See p. 165.***1567—GOLD OXIDE.**

Lyman, Sons &amp; Co., Montreal, Que.

**1568—GONGS—Electric.**Toronto Electrical Works, Toronto, Ont.  
Mount Bros., Montreal, Que.  
Peterboro Lock Mfg Co., Peterboro, Ont. *See p. 219.***1569—GONGS—Fire Alarm, Hotel, Street Car, Ship.**Garth & Co., Montreal, Que. *See page 154.*  
Peterboro Lock Mfg Co., Peterboro, Ont. *See p. 219.*  
Morrison (James) Brass Mfg Co., Toronto, Ont.Macdonald & Co., Ltd. Halifax, N.S. *See p. 256.*  
McAvity, T. & Sons, St. John, N.B. *See page 153.***1570—GOVERNORS—Steam Engine, 'Evans' Patent.**

Leonard, E. &amp; Sons, London, Ont.

**1571—GOVERNORS—Gas.**

Citizen's Gas Control Co., Montreal, Que.

**1572—GOVERNORS—Steam, Water Wheel, Steam Pump.**Myers, W. F. & J. W., St. John, N. B. *See page 163.*

- Hamilton Mfg Co. Ltd. (The Wm.), Peterboro, Ont.  
Carrier, Laine & Co., Levis, Que. *See page 150.*  
Goldie & McCulloch Co. Ltd., Galt, Ont. *See p. 159.*  
Robb Engineering Co. Ltd., Amherst, N. S.  
*See inside front cover.*  
Paxton, Tate & Co., Port Perry, Ont.
- 1573—GRANITE—Red, (Rough).**  
New Brunswick Red Granite Co., St. Stephens, N.B.  
Sleeth, Quinlan & Co., St. John, N. B.  
Epps, Dodd & Co., St George, N. B.  
Milne, Coutts & Co., St. George, N. B.
- 1574—GRANITE WARE—White.**  
St. Johns Stone & Chinaware Co., St. Johns, Que.
- 1575—GRANULES—Effervescing.**  
Stearns, Fred'k & Co., Windsor, Ont. *See back cover.*
- 1576—GRANULES—(with Cereals), Milk.**  
Johnston's Fluid Beef Co., Montreal, Que. *Advt. 235.*
- 1577—GRASS—(Sea), Upholsterers'.**  
Morris, F., Bradford, Ont.  
Collings, E., Bradford, Ont.  
Cooper, A., Bradford, Ont.  
Courrier, Paul, Bradford, Ont.  
Lowe, Frank, Bradford, Ont.  
Goodwin, Joseph, Holland Landing, Ont.  
Morris, T., Bradford, Ont.
- 1578—GRATERS—(Tin) Box, Coconut, Horse-radish, Nutmeg, Vegetable.**  
Davidson Mfg Co. (Thos.), Montreal, Que. *See p. 225.*
- 1579—GRATES—Fire Place, Mantle, Register, Floor, Stove, Wall Register.**  
Carrier, Laine & Co., Levis, Que. *See page 150.*  
Burns & Co., Halifax, N. S.  
Gurney, Tilden Co., Ltd., Hamilton, Ont. *Advt. 151.*  
Ives, H. R. & Co., Montreal, Que. *Advt. page 200.*  
Gurney Foundry Co. Ltd., Toronto, Ont.  
Stewart, (Jas), Mfg Co., Woodstock, Ont.  
New York Mantel Decorating Co., Montreal, Que.  
Enterprise Foundry Co., Sackville, N. B.
- 1580—GRATES—Furnace, Boiler.**  
Garth & Co., Montreal, Que. *Advt. page 154.*  
Gurney, Tilden Co. Ltd., Hamilton, Ont. *Advt. p. 151.*  
Laurie Engine Co., Montreal, Que. *Advt. page 179.*  
Star Iron Co., Montreal, Que. *Advt. page 243.*  
Young & Bro. Co. Ltd., Hamilton, Ont. *Advt. 257.*  
Fleck, Alex. Jr., Ottawa, Ont. *Advt. page 252.*  
Carrier, Laine & Co., Levis, Que. *Advt. page 150.*  
Bertram, John & Sons, Dundas, Ont. *Advt. page 161.*  
Babcock & Wilcox Co., Montreal, Que. *Advt. p. 194.*
- 1581—GRATINGS—(Iron), Area, Cast, Door, Jail, Sidewalk, Window, Wrought.**  
Ives, H. R. & Co., Montreal, Que. *Advt. page 200.*  
Garth & Co., Montreal, Que. *Advt. page 154.*  
Dennis, R., London, Ont. *Advt. page 207.*  
Gurney, Tilden Co. Ltd., Hamilton, Ont. *Advt. 151.*  
Loignon, A. & E., Montreal, Que. *Advt. page 247.*  
Macdonald, J. K., Montreal, Que. *Advt. page 247.*  
Carrier, Laine & Co., Levis, Que. *Advt. page 150.*
- 1582—GREASE—Axle, Belt.**  
Canada Paint Co., Montreal, Que. *Advt. page 221.*  
Ramsay, A. & Son, Montreal, Que. *Advt. page 211.*  
Rogers, Samuel & Co., Toronto, Ont. *Advt. p. 240.*
- 1583—GREASE—Pipe Joint.**  
Young & Bro. Co. Ltd., Hamilton, Ont. *Advt. 257.*
- 1584—GREASE—Soap.**  
Harris, W. & Co., Toronto, Ont.  
St. Jacob's Glue Co., St. Jacobs, Ont. *Advt. p. 229.*  
Nowell, B. L. & Co., Montreal, Que.
- 1585—GREASE—Bear's.**  
Evans and Sons, Ltd., Montreal, Que.
- 1586—GREASES—Cut, Dynamo, Lubricating, Cog, Dredge, Saw Mill, Graphite.**  
Imperial Oil Co., Petrolia, Ont. *Advt. page 230.*  
Rogers, Samuel & Co., Toronto, Ont. *Advt. p. 240.*
- 1587—GREEN—Paris.**  
Canada Paint Co., Montreal, Que. *Advt. page 221.*  
Ramsay, A. & Son, Montreal, Que. *Advt. page 211.*  
Peuchen & Co., Toronto, Ont.
- 1588—GRIDDLES—(Iron), Cake. See No. 1739.**
- 1589—GRILLE WORK—(Iron) Bank & Office.**  
Garth & Co., Montreal, Que. *Advt. page 154.*  
Starr Mfg Co. Ltd., Halifax, N.S. *Advt. page 199.*  
Mitchell, R. & Co., Montreal, Que. *Advt. page 213.*  
Macdonald, J. K., Montreal, Que. *Advt. page 247.*  
Toronto Fence Ornamental Iron Works, Toronto, Ont.  
Dennis, R., London, Ont. *Advt. page 207.*  
Dominion Ornamental Iron Co., Montreal, Que.
- 1590—GRILLE WORK—(Wood), Bank & Office.**  
Rhodes, Curry & Co. Ltd., Amherst, N.S. *Advt. 158.*  
Edwards, W. C. & Co. Ltd., Ottawa, Ont. *Advt. 219.*  
Snider, John B., Waterloo, Ont. *Advt. page 231.*  
Rathbun (The) Co., Deseronto, Ont. *Advt. page 162.*  
Otterville Mfg Co. Ltd., Otterville, Ont. *Advt. 259.*  
New York Mantel Decorating Co., Montreal, Que.  
Gignac, O. & Fils, Quebec, Que.
- 1591—GRILLE WORK—Brass.**  
American Copper Co., Toronto, Ont. *Advt. p. 157.*  
Hamilton Brass Mfg Co., Hamilton, Ont. *Advt. 168.*
- 1592—GRIPS—Elevator Hand & Lock Stop.**  
Miller Bros. & Toms, Montreal, Que. *Advt. p. 197.*  
Fensom, John, Toronto, Ont.  
Kerr & Morgan, Montreal, Que. *Advt. page 220.*  
Myers, W. F. & J. W., St. John, N.B. *Advt. p. 163.*
- 1593—GRINDERS—Emery Wheel, (Double & Single), Planer Knife.**  
Ballantine, John & Co., Preston, Ont. *Advt. page 205.*  
Bertram, John & Sons, Dundas, Ont. *Advt. page 161.*  
Hart Emery Wheel Co., Hamilton Ont. *Advt. p. 166.*  
Prescott Emery Wheel Co., Prescott, Ont. *Advt. 237.*
- 1594—GRINDERS—Reamer, Universal Cutter**  
Jardine, A. B. & Co., Hespeler, Ont. *Advt. page 217.*
- 1595—GRINDERS—(Emery), Foot Power, Hand Power, Kitchen, Shop.**  
Hart Emery Wheel Co., Hamilton, Ont. *Advt. 166.*  
Cooke Hardware Co., Hamilton, Ont. *Advt. p. 166.*  
Prescott Emery Wheel Co., Prescott, Ont. *Advt. 237.*
- 1596—GRINDERS—Emery, "Huntington's Patent", "Hardie's Patent".**  
Hart Emery Wheel Co., Hamilton, Ont. *Advt. 166.*

**1597—GRINDERS—Centre, Knife, Combination.**

Bertram, John & Sons, Dundas, Ont. *Advt. page 161.*  
Goldie & McCulloch Co. Ltd., Galt, Ont. *Advt. p. 159.*  
Gardner, Rob't & Son, Montreal, Que.  
MacGregor, Gourlay & Co., Galt, Ont.  
Cant Bros. Co. Ltd., Galt, Ont. *Advt. page 259.*

**1598—GRINDERS—(Emery), Bench, Counter Shaft, Lathe-Centre, Stove Plate, Suspension, Tool, Saw, Hollow Ware.**

Hart Emery Wheel Co., Hamilton, Ont. *Advt. p. 166.*  
Prescott Emery Wheel Co., Prescott, Ont. *Advt. 237.*

**1599—GRINDERS—Grain "Vessot's".**

Vessot, S. & Co., Joliette, Que. *Advt. page 238.*

**1600—GRINDERS—Grain, Feed.**

Goold, Shapley & Muir, Co. Ltd., Brantford, Ont.  
*Advt. page 191.*  
Vessot, S. & Co., Joliette, Que. *Advt. page 238.*  
Moody, Matthew & Sons, Terrebonne, Que.  
*Advt. page 209.*

**1601—GRINDERS—Pulp (for the reduction of mechanical wood pulp).**

Jenckes Machine Co., Sherbrooke, Que. *Advt. 165.*

**1602—GRINDERS—Shimer Head, Moulding Bit.**

Hart Emery Wheel Co., Hamilton, Ont. *Advt. 166.*

**1603—GRINDSTONES.**

Fish, C. E., Newcastle, N.B. *Advt. page 229.*

**1604—GROMMETS—Iron Ring.**

Ives, H. R. & Co., Montreal, Que. *Advt. page 200.*  
Carrier, Laine & Co., Levis, Que. *Advt. page 150.*  
Garth & Co., Montreal, Que. *Advt. page 154.*

**1605—GROOVERS—Double Seamers, Hand, Tinsmiths'.**

Brown, Boggs & Co., Hamilton, Ont. *Advt. p. 193.*

**1606—GUARDS—Knife Head, Reaper & Mower, Reaper & Flower Knife.**

Whitman & Barnes Mfg Co., St. Catharines, Ont.

**1607—GUARDS—Trouser, (Bicyclists'.**

Goold Bicycle Co. Ltd., Brantford, Ont. *Advt. 220.*  
St. Lawrence Steel Wire Co., Gananoque, Ont.  
*Advt. page 183.*

**1608—GUARDS—Cattle, Low's Patent, Railway, Surface.**

Central Bridge & Engineering Co., Peterbororo, Ont.  
*Advt. page 214.*

**1609—GUARDS—(Iron), Door, Skylight.**

Dennis, R., London, Ont. *See page 207.*  
Garth & Co., Montreal, Que. *See page 154.*  
Toronto Fence & Iron Works, Toronto, Ont.  
Ives, H. R. & Co., Montreal, Que. *See page 200.*  
Munro Bros., New Glasgow, N.S. *See page 244.*

**1610—GUARDS—(Brass), Window, Counter.**

Hamilton Brass Mfg Co., Hamilton, Ont. *Advt. 168.*  
McAvity, T. & Sons, St. John, N. B. *Advt. page 152.*

**1611—GUARDS—Piano.**

Woodyatt, A. R. & Co., Guelph, Ont. *See page 207.*

**1612—GUARDS—(Wire), Spark, Stove, Tree, Window.**

Meadows, George B., Toronto, Ont.  
Dennis, R., London, Ont. *See page 207.*  
Greening, (The B.) Wire Co. Ltd., Hamilton, Ont.

**1613—GUDGEONS.**

Brown, (G. & J.) Mfg Co., Belleville, Ont. *See p. 198.*  
Wilson, J. C. & Co., Glenora, Ont.

**1614—GUIDES—Saw.**

Carrier, Laine & Co., Levis, Que. *Advt. page 150.*  
Canadian Locomotive & Engine Co., Kingston, Ont.  
*Advt. page 175.*  
Ballantine, John & Co., Preston, Ont. *Advt. p. 205.*  
Chalifoux, O. & Sons, St. Hyacinthe, Que. *Advt. 232.*  
Cant Bros. Co. Ltd., Galt, Ont. *Advt. p. 259.*  
Hamilton (Wm.) Mfg Co. Ltd., Peterborough, Ont.  
MacGregor, Gourlay & Co., Galt, Ont.

**1615—GUITARS.**

Whaley, Royce Co., Toronto, Ont. *Advt. page 189.*

**1616—GUM—Pure Sheet.**

Canadian Rubber Co., Montreal, Que. *Advt. p. 197.*  
Gutta Percha & Rubber Mfg Co. Ltd., Toronto, Ont.  
*See back cover.*

**1617—GUM—Dental.**

Canadian Rubber Co., Montreal, Que. *Advt. p. 197.*  
Alpha Rubber Co. Ltd., Montreal, Que.

**1618—GUMS—Adhesive.**

Cheesebrough Mfg Co., Montreal, Que. *Advt. 259.*

**1619—GUM—Padding.**

Canada Printing Ink Co., Toronto, Ont.

**1620—GUM—Chewing (Pepsin).**

Sommerville, C. R., London, Ont. *Advt. page 235.*

**1621—GUNS—Spun Metal.**

Chadwick Bros., Hamilton, Ont. *Advt. page 206.*

**1622—GUTTERS & TRAPS—Stable. (Iron).**

*See Iron Stable Fittings No. 1831.*

**1623—HAEMINAL.**

Parke, Davis & Co., Walkerville, Ont.

**1624—HACKS—Livery.**

Campbell, John, London, Ont.

**1625—HADDIE—Smoked. See No. 1416.**

**1626—HAIR—Horse.**

Leadlay, E. & Co., Toronto, Ont.  
Harris, W. & Co., Toronto, Ont.  
Hallam, John, Toronto, Ont.

**1627—HAIR—Deer, Goat.**

Clarke, A. R. & Co., Toronto, Ont.

**1628—HAIR—Curled.**

Canada Fibre Co., Montreal, Que.

**1629—HAIR—Plastering.**

Clark, A. R. & Co., Toronto, Ont.  
Trudel, L. E., Quebec, Que.  
Robson, Thomas, Lindsay, Ont.  
Lisle, Alfred, Lindsay, Ont.  
Berry, M. B., Quebec, Que.

Fox, Albert, Cote St. Paul, Que.  
Harris, W. & Co., Toronto, Ont.

**1630—HALTERS—Rope.**

Dovercourt Twine Mills Co. Ltd., Toronto, Ont.  
*Advt. page 184.*

Lochrie, James, Toronto, Ont.

**1631—HALTERS—Leather.** *See Harness No. 1669.*

**1632—HAMERS—Wood & Iron.**

Skinner & Co., Gananoque, Ont. *Advt. page 255.*

**1633—**

**1634—HAMMERS—Tack.**

Smart (James) Mfg Co., Brockville, Ont. *Advt. 178.*  
Whitman & Barnes Mfg Co., St. Catharines, Ont.  
Warnock, James & Co., Galt, Ont.  
Ives, H. R. & Co., Montreal, Que. *Advt. page 200.*

**1635—HAMMERS—Cast Iron.**

Smart (James) Mfg Co., Brockville, Ont. *Advt. 178.*  
Ives, H. R. & Co., Montreal, Que. *Advt. page 200.*  
Parker, Moses, Montreal, Que. *Advt. page 197.*

**1636—HAMMERS—Log.**

Wallace, Wm., Three Rivers, Que. *Advt. page 216.*  
Patterson & Heward, Toronto, Ont. *Advt. page 201.*  
Fell, I. C. & Co., Toronto, Ont.  
Drake, F. J., Belleville, Ont. *Advt. page 175.*

**1637—HAMMERS—Law's Pat., "Optimates."**

Central Bridge & Engineering Co. Ltd., Peterboro,  
Ont. *Advt. page 214.*

**1638—HAMMER—Magnetic.**

Magnetic Hammer Co., St. Hyacinthe, Que.

**1639—HAMMERS—Malleable.**

Kyle, P., Merrickville, Ont.

**1640—HAMMERS—Piano.**

Bohne, W. & Co., Toronto, Ont.

**1641—HAMMERS—Saw.**

Ballantine, John & Co., Preston, Ont. *Advt. p. 205.*

**1642—HAMMERS—Air Cushion, Drop, Power,  
Steam, Trip.**

Kerr & Morgan, Montreal, Que. *Advt. page 220.*  
Bertram, John & Sons, Dundas, Ont. *Advt. page 161.*  
Brown, (G. & J.) Mfg Co., Belleville, Ont. *Advt. 198.*  
Miller Bros. & Toms, Montreal, Que. *Advt. p. 197.*  
Stevens, Hamilton & Co., Galt, Ont.

**1643—HAMMERS—(Tinnets'), Eavetrough,  
Flanging, Planishing, Raising, Setting.**

*See No. 2630.*

**1644—HAMMERS—Blacksmiths', Carpenters',  
Cast Steel, Coopers', Masons', Riveting.**

St. Maurice Tool & Ax Works, Three Rivers, Que.  
Whitman & Barnes Mfg Co., St. Catharines, Ont.  
Gardner, (W. R.) Tool Co., Brockville, Ont.  
Warnock, James & Co., Galt, Ont.  
Broad, E. Sons & Co. Ltd., St. Stephens, N. B.

**1645—HAMMOCKS—Twine.**

Gendron Mfg Co. Ltd., Toronto, Ont. *Advt. p. 187.*

Dovercourt Twine Mills Co. Ltd., Toronto, Ont.  
*Advt. page 184.*

Montreal Tent, Awning & Tarpaulin Co., Montreal,  
Que. *Advt. page 232.*

Sonne, Thomas, Montreal, Que.

Talbot, William & Co., Elora, Ont.

**1646—HAMMERS—Wicker.**

Pelosse, P., Montreal, Que. *Advt. page 234.*

**1647—HANDLES—Cross Cut Saw.**

Skinner & Co., Gananoque, Ont. *Advt. page 255.*  
Still, J. H., St. Thomas, Ont.  
Welland Vale Mfg Co., St. Catharines, Ont. *Advt. 241.*  
Wesley, F. J. & Co., Toronto Junction, Ont.  
Crawford, W. C., Tilbury Centre, Ont.

**1648—HANDLES—Pail.** *See No. 2375.*

**1649—HANDLES—Carriage Door.** *See No. 1658.*

**1650—HANDLES—Cork Bicycle.**

Cork Co. of Canada Ltd., Toronto, Ont. *Advt. 187.*

**1651—HANDLES—Cant Hook, Peavy.**

Strathroy Mfg Co. Ltd., Strathroy, Ont.  
McLeod Bros., Truro, N.S.  
Still, J. H., St. Thomas, Ont.

**1652—HANDLES—Bicycle.**

Goold Bicycle Co., Brantford, Ont. *Advt. page 220.*  
Canadian Rubber Co., Montreal, Que. *Advt. p. 197.*  
Canadian Rubber Co., Toronto, Ont. *Advt. page 197.*  
Gendron Mfg Co. Ltd., Toronto, Ont. *Advt. p. 187.*  
Kingston Vehicle Co. Ltd., Kingston, Ont. *Advt. 202.*

**1653—HANDLES—(Metal), Carriage Seat,  
Cheese Hoop, Milk Can, Seat, Boiler, Tea  
Pot.**

Smart (James) Mfg Co., Brockville, Ont. *Advt. 178.*  
Skinner & Co., Gananoque, Ont. *Advt. page 255.*  
Burrow, Stewart & Milne, Hamilton, Ont.  
Frost, W. H., Smith's Falls, Ont.  
Kyle, P., Merrickville, Ont.

**1654—HANDLES—Draw Shave, Socket Chi-  
sel, Auger-Awl, Screw Driver.**

Goulette, O. V., Gananoque, Ont. *Advt. page 214.*  
Hambleton & Co., Hampton, N.B.

**1655—HANDLES—Adze, Axe, Blacksmiths',  
Brush, Broom, Carpet Sweeper, Farming  
Tool.**

Button & Fessant, Wingham, Ont. *Advt. p. 251.*  
Deutschmann, Fred'k., Wingham, Ont. *Advt. 218.*  
Thompson, W. R., Teeswater, Ont. *Advt. page 233.*  
Still, J. H., St. Thomas, Ont.  
Strathroy Mfg Co. Ltd., Strathroy, Ont.  
Crawford, W. C., Tilbury Centre, Ont.  
Wood, Robt., Snow Road, Ont.

**1656—HANDLES—Leather.**

Robin, Sadler & Haworth, Montreal, Que. *Advt. 226,*

**1657—HANDLES—Parasol, Umbrella.**

Irving & Co., Toronto, Ont.

**1658—HANDLES—(Metal), Chest, Door,  
Drop, Furniture, Sad Iron, "Latches",  
Catches, &c., &c.**

Garth & Co., Montreal, Que. *Advt. page 154.*

Gurney, Tilden Co. Ltd., Hamilton, Ont. *Advt. 151.*  
Smart, (Jas.) Mfg Co., Brockville, Ont. *Advt. p. 178.*  
Woodyatt, A. R. & Co., Guelph, Ont. *Advt. p. 207.*  
Peterboro Lock Mfg Co., Peterboro, Ont. *Advt. 219.*  
Ives, H. R. & Co., Montreal, Que. *Advt. page 200.*

**1659—HANDLES—Children's Carriage.**

Gendron Mfg Co. Ltd., Toronto, Ont. *Advt. p. 187.*

**1660—HANDLES—Surface Chest.**

*See Handles No. 1658.*

**1661—HANDLES—Net Landing.**

McLeod Bros., Truro, N. S.

**1662—HANGERS—Pipe.** *See No. 1746.*

**1663—HANGER—(Cast Iron), Patent.**

Parker, Moses, Montreal, Que. *Advt. page 197.*

**1664—HANGERS—Elevator Door, Eave Trough.**

Garth & Co., Montreal, Que. *Advt. page 154.*  
Kerr & Morgan, Montreal, Que. *Advt. page 220.*  
Miller Bros. & Toms, Montreal, Que. *Advt. p. 197.*  
Fensom, John, Toronto, Ont.  
Smart, (Jas.) Mfg Co., Brockville, Ont. *Advt. p. 178.*

**1665—HANGERS—(Leather) Bell Cord.**

Robin, Sadler & Haworth, Montreal, Que. *Advt. 226.*

**1666—HANGERS—(Iron Door), Drop, Sliding, Street Car.**

Garth & Co., Montreal, Que. *Advt. page 154.*  
Woodyatt, A. R. & Co., Guelph, Ont. *Advt. p. 207.*  
Kerr & Morgan, Montreal, Que. *Advt. page 220.*  
Miller Bros. & Toms, Montreal, Que. *Advt. page 197.*  
Myers, W. F. & J. W., St. John, N. B. *Advt. p. 163.*  
Ives, H. R. & Co., Montreal, Que. *Advt. page 200.*  
Peterboro Lock Mfg Co., Peterboro, Ont. *See p. 219.*  
Smart, (Jas.) Mfg Co., Brockville, Ont. *Advt. p. 178.*

**1667—HANGERS—Parting, Post, Self Oiling, Ring Oiler.**

Myers, W. F. & J. W., St. John, N.B. *Advt. 163.*  
Miller Bros. & Toms, Montreal, Que. *Advt. p. 197.*  
Parker, Moses, Montreal, Que. *Advt. page 197.*  
Valleyfield Foundry & Machine Works, Valleyfield, Que. *Advt. page 191.*  
Garth & Co., Montreal, Que. *Advt. page 154.*  
Kerr & Morgan, Montreal, Que. *Advt. page 220.*  
Gardner, Robt. & Son, Montreal, Que.  
Brush, Geo., Montreal, Que.  
McDonald & Co. Ltd., Halifax, N.S., *Advt. p. 256.*  
Fraser Bros., New Glasgow, N.S. *Advt. page 252.*  
Three Rivers Iron Works, Three Rivers, Que.

*Advt. page 179.*

Robb Engineering Co. Ltd., Amherst, N.S.  
*See inside front cover.*

Lancaster Machine Works, Lancaster, Ont. *Advt. 248.*  
Waring, White & Co., St. John, N.B. *Advt. p. 256.*  
Paxton, Tate & Co., Port Perry, Ont.  
Brown (G. & J.) Mfg Co., Belleville, Ont. *Advt. 198.*

**1668—HARDIES—Blacksmiths'.**

Whitman & Barnes Mfg Co., St. Catharines, Ont.

**1669—HARNESS—Carriage, Cart, Coach, Double, Express, Plow, Road, Single, Wagon, "Leather Straps", Halters, Collars, Housing.**

Hutchings, E. T., Winnipeg, Man.

Adams Bros., Toronto, Ont.  
Acton, W. R., Gananoque, Ont.  
Ackerman, B. F., Peterboro, Ont.  
Borbridge, S. & H., Ottawa, Ont.  
Rudd, George A. & Co., Brockville, Ont.  
Verreault, Henri, Levis, Que.

**1670—HARPS—(Metal), Lamp.**

Young & Bro. Co. Ltd., Hamilton, Ont. *Advt. 257.*

**1671—HARROWS—Reversible Disk.**

Grout, John H. & Co., Crimsby, Ont.

**1672—HARROWS—Iron, (Diamond Frame).**

Stratford Bridge & Iron Works Co., Stratford, Ont.  
*Advt. page 252.*

**1673—HARROWS—Diamond Steel.**

Hamilton Mfg Co. (Peter), Peterboro, Ont. *Advt. 209.*

**1674—HARROWS—Set Lever, Harrows & Seeders Combined.**

Moody, Matthews & Sons, Terrebonne, Que.  
*Advt. page 209.*

**1675—HARROWS—Spring Tooth.**

Hamilton Mfg Co. (Peter), Peterboro, Ont. *Advt. 209.*  
Joliette Foundry Co., Joliette, Que.  
Moody, Matthew & Sons, Terrebonne, Que.  
*Advt. page 209.*

Steel Harrow Co., New Glasgow, N. S.

Frost & Wood, Smith's Falls, Ont.

McNeil, P. W., New Glasgow, N. S.

Connell Bros., Woodstock, N. B.

**1676—HARROWS—Rotary Disk, Vibrating.**

Waterloo Mfg Co. Ltd., Waterloo, Ont. *Advt. p. 218.*  
Wortman & Ward Mfg Co. Ltd., London, Ont.  
Bissett, T. E., Prescott, Ont.  
Grout, John H. & Co., Crimsby, Ont.  
Sleeper & Akhurst, Coaticook, Que. *Advt. page 241.*  
McKinnon & McLean, Charlottetown, P. E. I.  
Maxwell, David & Sons, St. Mary's, Ont. *Advt. 250.*

**1677—HARVESTERS—Pea.**

Skinner & Co., Gananoque, Ont. *Advt. page 255.*  
Whitman, James, Amulree, Ont.  
Sylvester Bros. Mfg Co., Lindsay, Ont.  
Tollon Bros., Guelph, Ont.

**1678—HARVESTERS—Clover, Twine Bind'g.**

Hamilton (Peter) Mfg Co., Peterboro, Ont. *Advt. 209.*  
Noxon Bros. Mfg Co., Ingersoll, Ont.  
Moody, Matthew & Sons, Terrebonne, Que. *Advt. 209.*  
Frost & Wood, Smith's Falls, Ont.  
Sylvester, Bros. Mfg Co., Lindsay, Ont.  
Bell, B. & Son, St. George, Ont.  
Maxwell, David & Sons, St. Mary's, Ont. *Advt. 250.*

**1679—HATCHES—Elevator Safety.**

Myers, W. F. & J. W., St. John, N.B., *Advt. p. 163.*  
Fensom, John, Toronto, Ont.  
Kerr & Morgan, Montreal, Que. *Advt. page 220.*  
Miller Bros. & Toms, Montreal, Que. *Advt. p. 197.*  
Leitch & Turnbull, Hamilton, Ont.

**1680—HATCHETS—Bench, Chopping, Claw, Half, Lathing, Round Faced, Shingling, Warehouse.**

Broad, E. & Sons Co. Ltd., St. Stephens, N.B.  
Warnock, James & Co., Galt, Ont.

Whitman & Barnes Mfg Co., St. Catharines, Ont.  
Gardner (W. R.) Tool Co., Brockville, Ont.

**1681—HATS—Ladies' Lace.**

Mahony & Co., Toronto, Ont.

**1682—HATS—Rubber.**

Canadian Rubber Co., Montreal, Que. *Advt. 197.*

**1683—HATS—(Straw), Children's, Ladies',  
Men's, Youth's, (Bonnet & Hat Frames).**

Godin, Joseph, Cote St. Paul, Que.  
Dominion Straw Goods, Mfg Co., Montreal, Que.  
Molleur, J. L., St. Johns, Que.  
Ontario Straw Goods Mfg Co. Ltd., Toronto, Ont.  
Guillet, E. & Co., Marieville, Que.  
Imperial Straw Works, Hamilton, Ont.  
Hamilton Straw Works, Hamilton, Ont.

**1684—HATS & CAPS—Band, Bicycle, Club,  
Firemen's, Police, Military, Society,  
Uniform, Yacht.**

Coddington, W. H., Hamilton, Ont. *Advt. p. 183.*

**1685—HATS & CAPS—Oiled.**

Soper, R., Hamilton, Ont. *Advt. page 229.*  
Canadian Oiled Clothing Co. Ltd., Port Hope, Ont.  
Turner, J. J. & Son, Peterboro, Ont.  
Strachan & Hay, Toronto, Ont.

**1686—HATS & CAPS—Derby, Cloth, Felt,  
Silk.**

Coddington, W. H., Hamilton, Ont. *Advt. page 183.*  
Everett, C. & E., St. John, N. B.  
Hughes, R. & Co., Toronto, Ont.  
Godin, Joseph, Cote St. Paul, Que.  
American Felt Hat Co. Ltd., Toronto, Ont.  
Magee's Sons (D.), St. John, N. B.

**1687—HAULAGE—Wire Rope.**

Dominion Wire Rope Co., Montreal, Que. *Advt. 171.*  
Wilson, James, Merritton, Ont.  
Greening, (The B.) Wire Co. Ltd., Hamilton, Ont.

**1688—HAY. See Merchants No. 3854.**

**1689—HAY—Chopped.**

Toronto Hay Cutting Co., Toronto, Ont.  
Crowe, John, Montreal, Que.

**1690—HEADERS—Branch.**

Young & Bro. Co. Ltd., Hamilton, Ont. *Advt. 257.*

**1691—HEADING—Nail Keg.**

Rousseau, J. A., St. Anne de la Pérade, Que.

**1692—HEADING—Cheese Box.**

Acme Veneer Works, Orillia, Ont. *Advt. page 217.*  
Wenger, N. & Bros., Ayton, Ont.  
Parker & Howe, Dixville, Que.  
Flewelling (G. & G.) Mfg Co., Hampton, N.B.  
Biette & Co., Chesley, Ont. *Advt. page 240.*  
Basinet Charles, St. Jean de Matha, Que.  
Beausolois, E., St. Jean de Matha, Que.  
Baril, F., Warwick, Que.  
Copping William, Joliette, Que.

**1693—HEADING & STAVES—Barrel, (Slack)  
*See No. 3255.***

**1694—HEADS—Drum, (Calf Skin).**

Pett, James, Hamilton, Ont.

**1695—HEADS—Exhaust Pipe, Piston.**

Garth & Co., Montreal, Que. *Advt. page 154.*  
Carrier, Lajne & Co., Levis, Que. *Advt. page 150.*

**1696—HEADS—Lathe, Matcher.**

Bertram, John & Sons, Dundas, Ont. *Advt. page 161.*  
Robb Engineering Co. Ltd., Amherst, N. S.  
*See inside front cover.*  
MacGregor, Gourlay & Co., Galt, Ont.

**1697—HEADS—Spinning Wheel.**

Goulette, O. V., Gananoque, Ont. *Advt. page 214.*

**1698—HEADS—Iron Post.**

Woodyatt, A. R. & Co., Guelph, Ont. *Advt. page 207.*

**1699—HEADS—Cross.**

Garth & Co., Montreal, Que. *Advt. page 154.*  
Laurie Engine Co., Montreal, Que. *Advt. page 170.*  
Lancaster Machine Works, Lancaster, Ont. *Advt. 248.*

**1700—HEADS—Bill, Invoice, Letter.**

Gage Co. Ltd. (W. J.), Toronto, Ont. *Advt. p. 189.*  
Doust, Joseph, Toronto, Ont.  
Brown Bros. Ltd. (The), Toronto, Ont.  
Mortimer & Co., Ottawa, Ont.

**1701—HEADS & CUTTERS—Shimer.**

Ballantine, John & Co., Preston, Ont. *Advt. p. 205.*

**1702—HEAD STONES—Slate.**

New Rockland Slate Co., Montreal, Que. *Advt. 244.*

**1703—HEADWEAR — Children's, Infants',  
Embroidered, Linen, Nurses.**

Mahony & Co., Toronto, Ont.

**1704—HEARSES.**

Guy, Matthew, Toronto, Ont.  
DeWolf, Son & Co., Halifax, N.S.,  
Thompson, W. J. & Sons, London, Ont.  
Nash, B. J. & Co., London, Ont.

**1705—HEARTHES—Slate.**

New Rockland Slate Co., Montreal, Que. *Advt. 244.*  
Burns & Co., Halifax, N.S.  
Danville Asbestos & Slate Co., Danville, Que.

**1706—HEATERS—Hot Water for Hot Air  
Furnaces.**

Bigley, R., Toronto, Ont. *Advt. page 242.*

**1707—HEATERS—Gas.**

Bigley, R., Toronto, Ont. *Advt. page 242.*

**1708—HEATERS—Glue.**

Robb Engineering Co. Ltd., Amherst, N.S.  
*See inside front cover.*

**1709—HEATERS—Car.**

Ahearn & Soper, Ottawa, Ont.  
Sleeper & Akhurst, Coaticook, Que. *Advt. p. 241.*

**1710—HEATERS—Wheat.**

Goldie & McCulloch Co. Ltd., Galt, Ont. *Advt. 159.*  
Greedy, Wm. & J. G. Toronto, Ont.

**1711—HEATERS—Sad Iron.**

Gurney, Tilden Co. Ltd., Hamilton, Ont. *Advt. 151.*  
Smart (James) Mfg Co., Brockville, Ont. *Advt. 178.*  
Ives, H. R. & Co., Montreal, Que. *Advt. page 200.*



**1712—HEATERS—Hot Water, Steam, Portable Steam.** See No. 1713.

**1713—HEATERS—Combination Steam and Warm Air, Combination Hot Air and Hot Water, Steam Heating Apparatus.**

Carrier, Laine & Co., Levis, Que. *Advt. page 150.*  
Garth & Co., Montreal, Que. *Advt. page 154.*  
Gurney, Tilden Co. Ltd., Hamilton, Ont. *Advt. 151.*  
Toronto Radiator Mfg Co., Toronto, Ont. *Advt. 152.*  
Gurney Foundry Co. Ltd., Toronto, Ont.  
Macdonald & Co. Ltd., Halifax, N. S. *Advt. p. 256.*  
King, Warden & Son, Montreal, Que.  
Star Iron Co., Montreal, Que. *Advt. page 243.*

**1714—HEATERS—Feed Water.**

Goldie & McCulloch Co. Ltd., Galt, Ont. *Advt. 159.*  
Morrison, Jas. Brass Mfg Co., Toronto, Ont. *Advt. 157.*  
Garth & Co., Montreal, Que. *Advt. page 154.*  
Waring, White & Co., St. John, N. B. *Advt. p. 256.*  
Macdonald & Co. Ltd., Halifax, N. S. *Advt. page 256.*  
Robb Engineering Co. Ltd., Amherst, N. S.  
*See inside front cover.*  
Babcock, Wilcox & Co., Montreal, Que. *Advt. p. 194.*  
Carrier, Laine & Co., Levis, Que. *Advt. page 150.*  
Goubert Mfg Co., Montreal, Que. *Advt. page 194.*

**1715—HEELS—Boot & Shoe.**

Rochette, C., Quebec, Que.  
Richard & Co., Quebec, Que.

**1716—HELMETS—Spun Metal.**

Chadwick Bros., Hamilton, Ont. *Advt. page 206.*

**1717—HERBS—Powdered, Pressed.**

Stearns, Fred'k & Co., Windsor, Ont. *See back cover.*  
Lyman Sons & Co., Montreal, Que.

**1718—HERRING.** See Fish No. 1416.

**1719—HESSIANS.**

Canada Jute Co. Ltd., Montreal, Que. *Advt. p. 225.*

**1720—HINGES—Double Acting Spring.**

Garth & Co., Montreal, Que. *Advt. page 154.*  
Peterboro Lock Mfg Co., Peterboro, Ont. *Advt. 219.*

**1721—HINGES—Butt, Hasp, Hasps & Staples, Gate, Self-closing, Shutter, Blind, Table, T. & Strap.**

Ives, H. R. & Co., Montreal, Que. *Advt. page 200.*  
Smart (James) Mfg Co., Brockville, Ont. *Advt. 178.*  
Swansea Forging Co., Swansea, Ont. *Advt. page 156.*  
Cowan & Britton, Gananoque, Ont.  
Woodyatt, A. R. & Co., Guelph, Ont. *Advt. page 257.*

**1722—HINGES—Door, Hook & Eye.** See No. 1721.

**1723—HINGES—Bronze, Brass, Iron.**

Garth & Co., Montreal, Que. *Advt. page 154.*  
Peterboro Lock Mfg Co., Peterboro, Ont. *Advt. 219.*  
Morrison (James) Mfg Co., Toronto, Ont. *Advt. 157.*

**1724—HIVES—Bee.**

Goold, Shapley & Muir, Brantford, Ont. *Advt. 191.*  
Phillips, T. & Co., Orillia, Ont. *Advt. page 259.*  
Russell, W. G., Millbrook, Ont.

**1725—HODS—Brass Coal.**

Mitchell, Robt. & Co., Montreal, Que. *Advt. p. 213.*

Coulter & Campbell, Toronto, Ont. *Advt. page 201.*  
McAvity, T. & Sons, St. John, N. B. *Advt. page 153.*  
Chadwick Bros., Hamilton, Ont. *Advt. page 206.*  
Hamilton Brass Mfg Co., Hamilton, Ont. *Advt. 168.*  
Parker, J. O., Toronto, Ont. *Advt. page 253.*

**1726—HODS—Coal, (Corrugated Steel & Iron), Japanned & Galvanized Iron.**

Davidson Mfg Co. (Thos.), Montreal, Que. *Advt. 225.*  
Kemp Mfg Co., Toronto, Ont.

**1727—HOES—Corn Wheel, Scuffler.**

Maxwell, David & Sons, St. Mary's, Ont. *Advt. p. 250.*  
Hamilton Mfg Co. (Peter), Peterboro, Ont. *Advt. 209.*  
Moody, M. & Sons, Terrebonne, Que. *Advt. p. 209.*  
Bell, B. & Son, St. George, Ont.  
Gowdy Mfg Co., Guelph, Ont.  
Waterloo Mfg Co. Ltd., Waterloo, Ont. *Advt. p. 218.*

**1728—HOES—(Hand), Eye, Field, Garden, Grub, Planters', Mortar, Riveted Shank & Socket.**

Rixford Mfg Co. (O. S.), Bedford, Que. *Advt. p. 241.*  
Welland Vale Mfg Co., St. Catharines, Ont. *Advt. 241.*  
Whiting Mfg Co. (A. S.), Whitby, Ont. *Advt. page 241.*  
Canada Axe & Harvest Tool Co., Cote St. Paul, Que.  
*Advt. page 241.*

Halifax Shovel Co., Halifax, N. S.

**1729—HOISTS—Clutch, Friction, Single & Double Drum, Travelling, Home Power, Mining Quarry.**

Brown, (G. & J.), Mfg Co., Belleville, Ont. *Advt. 198.*  
Myers, W. F. & J. W., St. John, N. B. *Advt. p. 163.*  
Beatty, M. & Sons, Welland, Ont. *Advt. page 173.*  
Jenckes Machine Co., Sherbrooke, Que. *Advt. p. 165.*  
Ingersoll Rock Drill Co., Montreal, Que. *Advt. 198.*  
Matheson, I. & Co., New Glasgow, N. S. *Advt. 200.*  
Mac Machine Co., Belleville, Ont. *Advt. page 194.*  
Wilson, Jas., Merriton, Ont.  
Macdonald & Co. Ltd., Halifax, N. S. *Advt. page 256.*

**1730—HOLDERS—(Brass), Broom, Brush, Mop.**

Garth & Co., Montreal, Que. *Advt. page 154.*  
Hamilton Brass Mfg Co., Hamilton, Ont. *Advt. 168.*  
Smart, (Jas.) Mfg Co., Brockville, Ont. *Advt. p. 178.*  
Peterboro Lock Mfg Co., Peterboro, Ont. *Advt. 219.*

**1731—HOLDERS—Roll Paper.**

Eddy Co. (The E. B.), Hull, Que.  
Young & Son, Montreal, Que.

**1732—HOLDERS—Paper Bag, Globe, Lamp Shade.**

American Copper Co., Toronto, Ont. *Advt. p. 157.*  
Davidson Mfg Co. (The), Montreal, Que. *Advt. 225.*

**1733—HOLDERS—Stable Broom.** See No. 1831.

**1734—HOLDER—Neck Tie.**

O'Reilly, H. M., Almonte, Ont.

**1735—HOLDER—(Log), Drag Saw.**

Canadian Locomotive & Engine Co. Ltd., Kingston, Ont. *Advt. page 175.*

**1736—HOLDERS—Conductor Pipe.**

Smart (James) Mfg Co., Brockville, Ont. *Advt. 178.*  
Young & Bro. Co. (The), Hamilton, Ont. *Advt. 257.*  
Parmenter & Bulloch, Gananoque, Ont. *Advt. 199.*

Lessard & Harris, Montreal, Que. *Advt. page 231.*  
Kyle, P., Merrickville, Ont.

**1737—HOLDERS—Chuck Drill, Chucking Reamer, Lathe Die Reamer.**

Bertram, John & Sons, Dundas, Ont. *Advt. p. 161.*  
Butterfield & Co., Rock Island, Que.  
Jardine, A. B. & Co., Hespeler, Ont. *Advt. page 217.*

**1738—HOLDERS—Tin.**

MacDonald Mfg Co., Toronto, Ont.

**1739—HOLLOW WARE—(Cast Iron).**

Garth & Co., Montreal, Que. *Advt. page 154.*  
Ives, H. R. & Co., Montreal, Que. *Advt. page 200.*  
Gurney, Tilden & Co., Montreal, Que. *Advt. p. 151.*  
Carrier, Laine & Co., Levis, Que. *Advt. page 150.*  
Joliette Foundry Co., Joliette, Que.  
Crossman & Laws, Amherst, N. S. *Advt. page 226.*  
Coleman, T. T. (Est. of), Seaforth, Ont.  
Smart, (Jas.) Mfg Co., Brockville, Ont. *Advt. p. 178.*  
Gurney Foundry Co. Ltd., Toronto, Ont.  
Enterprise Foundry Co., Sackville, N. B.

**1740—HOMESPUN.**

Hepworth, James R., Montreal, Que.  
Oxford Mfg Co., Oxford, N. S.  
Stanfield, C. E., Truro, N. S.  
Yarmouth Woolen Mills Co., Yarmouth, N. S.  
St. Croix Woolen Mfg Co. Ltd., St. Croix, N. S.

**1741—HONES—Sharpening.**

Cooke Hardware Co., Hamilton, Ont. *Advt. page 166.*

**1742—HOOKS—Belt, Sweat Pad.**

Parmenter & Bulloch, Gananoque, Ont. *Advt. 199.*

**1743—HOOKS—Grapple.**

Dobbie & Stuart, Thorold, Ont.

**1744—HOOKS—Cant, Peavies.**

Wallace, William, Three Rivers, Que. *Advt. p. 216.*  
Gillies, Geo. (The) Co., Gananoque, Ont. *Advt. 156.*

**1745—HOOKS—Floor Track Hanger, Pulley.**

Laing, Ritchie & Co., Essex, Ont. *See page 209.*

**1746—HOOKS & HANGERS—Pipe, Soil Pipe.**

Young & Bro. Co. Ltd., Hamilton, Ont. *See page 257.*

**1747—HOOKS—Chandelier, Lamp.**

Garth & Co., Montreal, Que. *See page 154.*  
Dominion Wire Mfg. Co., Montreal, Que. *See p. 176.*  
Smart Mfg Co. (James), Brockville, Ont. *See p. 178.*  
Canada Screw Co., Hamilton, Ont. *See page 226.*  
Peterboro Lock Mfg Co., Peterboro, Ont. *See p. 219.*  
Ives, H. R. & Co., Montreal, Que. *See page 200.*  
Young & Bro. Co. Ltd., Hamilton, Ont. *See p. 257.*  
Woodyatt, A. R. & Co., Guelph, Ont. *See page 207.*

**1748—HOOKS—Chain, Hay Fork.**

Garth & Co., Montreal, Que. *See page 154.*  
Matheson, I. & Co., New Glasgow, N.S. *See page 200.*  
Smart (James) Mfg Co., Brockville, Ont. *See p. 178.*

**1749—HOOKS—(Wire), Bird Cage, Screw.**

Dominion Wire Mfg Co., Montreal, Que. *See p. 176.*  
Canada Screw Co., Hamilton, Ont. *See page 226.*

**1750—HOOKS—Joint & Clevis, Wrought Iron Screw, Snap.**

Swansea Forging Co. Ltd., Swansea, Ont. *See p. 156.*  
Gillies, Geo. (The) Co., Gananoque, Ont. *See p. 156.*

**1751—HOOKS—Bolt, Breeching, Check, Rein, Sadlery, Strap, Tug, Bridle Checks.**

Skinner & Co., Gananoque, Ont. *See page 255.*  
Gillies, George Co., Gananoque, Ont. *See page 156.*

**1752—HOOKS—Flashing, Pad, Whiffletree.**

Kyle, P., Merrickville, Ont.  
Smart, (Jas.) Mfg Co., Brockville, Ont. *See page 178.*  
Parmenter & Bulloch, Gananoque, Ont. *See page 199.*  
Burrow, Stewart & Milne, Hamilton, Ont.  
Gillies, Geo. (The) Co., Gananoque, Ont. *See p. 156.*

**1753—HOOKS—Awning, Boat, Coat, Hall, Hammock, Hat, Wardrobe, Ceiling Screw, Clothes Line. See No. 1747.**

**1754—HOOKS—Brush, Corn, Grass, Potato, Weeding. See No. 2950.**

**1755—HOOKS—Harness, Stable, Tool.**

Woodyatt, A. R. & Co., Guelph, Ont. *See p. 207.*  
Tisdale Iron Stable Fitting Co. Ltd., Toronto, Ont. *See page 202.*

Skinner & Co., Gananoque, Ont. *See page 255.*  
Smart (James) Mfg Co., Brockville, Ont. *See p. 178.*  
Gillies Geo. (The) Co., Gananoque, Ont. *See p. 156.*  
Ives, H. R. & Co., Montreal, Que. *See page 200.*

**1756—HOOKS & EYES—Dress.**

Thorp, G. A. Mfg Co., Toronto, Ont.

**1757—HOOKS & EYES—Hardware, Gate.**

Dominion Wire Mfg Co., Montreal, Que. *See p. 176.*  
Canada Screw Co., Hamilton, Ont. *See page 226.*  
Smart Mfg Co. Ltd., Brockville, Ont. *See page 178.*  
Ives, H. R. & Co., Montreal, Que. *See page 200.*  
Woodyatt, A. R. & Co., Guelph, Ont. *See page 207.*

**1758—HOOKS & STAPLES.**

Cowan & Britton, Gananoque, Ont.  
Smart (James) Mfg Co., Brockville, Ont. *See p. 178.*

**1759—HOOPS—(Tin), Cheese.**

Chown, W. W. & Co., Belleville, Ont. *See p. 233.*

**1760—HOOPS—Coopers' Truss.**

Pontbriand & Bro., Sorel, Que.  
Toronto Hoop & Veneer Co'y., Toronto, Ont. *See page 234.*

**1761—HOOPS—Truss, (Surgical).**

Authors & Cox, Toronto, Ont.

**1762—HOOPS—Barrel.**

Steinhoff & Gordon, Wallaceburg, Ont. *Advt. p. 192.*  
Pardo, T. L., Cedar Springs, Ont.  
Rathbun (The) Co., Deseronto, Ont. *See page 162.*  
Palmer, I. M., Oil City, Ont.  
Drader, Wm. A., Northwood, Ont.  
McMachan, W., Renwick, Ont.  
Smith Bros., Stewart, Ont.

**1763—HOOPS—Cheese Box.**

Acme Veneer Works, Orillia, Ont. *See page 217.*  
Biette & Co., Chesley, Ont. *See page 240.*  
Baril, F., Warwick, Que.  
Toronto Hoop & Veneer Co'y., Toronto, Ont. *See page 234.*

Macpherson & Schell, Alexandria, Ont.

**1764—HOPPERS—Water Closet.**

Malcolm, W. B., Toronto, Ont.

**1765—HOREHOUND—Balsam of "Sharp's".**Armstrong & Co., St. John, N.B. *See page 229.***1766—HORNS—Tin.** *See No. 3486.***1767—HORSES—Hobby & Rocking, (Wood).**Gendron Mfg Co. Ltd., Toronto, Ont. *See p. 187.***1768—HOSE—Leather.**McLaren Belting Co. (The J. C.), Montreal, Que.  
Robin, Sadler & Haworth, Montreal, Que. *See p. 226.***1769—HOSE—Acid, Air, Air Brake, Brewers',  
Chemical Engine, Cotton Fire, Divers',  
Garden, Gas, Hydraulic, Lawn, Oil,  
Rubber Fire, Steam, Suction, Test.**Canadian Rubber Co., Montreal, Que. *See page 197.*  
Gutta Percha & Rubber Mfg Co. Ltd., Toronto, Ont.  
*See back cover.***1770—HOSE—Spiral Wire Suction, Smooth,  
Bore, Wire Bound "Kinkproof."**Gutta Percha & Rubber Mfg Co. Ltd., Toronto, Ont.  
*See back cover.***1771—HOSE—Fire (Linen).**Hamelin & Ayers, Lachute Mills, Que. *See page 188.*  
Forriester, Thos., Montreal, Que. *See front fly leaf.***1772—HOSIERY—Cotton, Merino, Cashmere.**Granite Mills, St. Hyacinthe, Que.  
Parks, Wm. J., St. John, N.B. *Advt. page 233.*  
Kingston Hosiery Co. Ltd., Kingston, Ont.**1773—HOSIERY—Woolen, Worsted.**Turnbull C. Co. Ltd., Galt, Ont. *Advt. page 203.*  
Stanfield, C. E., Truro, N.S.  
Lennard, S. & Sons, Dundas, Ont.  
Victoria Hosiery Co., St. Johns, Que.  
Burritt, A. & Co., Mitchell, Ont.  
Carter & Wootton, Guelph, Ont.**1774—HOSIERY—Silk.**Corticelli Silk Co. Ltd., St. Johns, Que. *Advt. 182.*  
Belding, Paul & Co. Ltd., Montreal, Que. *Advt 183.*  
Montreal Silk Mills Co. Ltd., Montreal, Que.**1774 a—HOTELS.** *See No. 3861.***1775—HOUSES—Portable, (Sheet Metal).**Metallic Roofing Co. of Canada Ltd. (The), Toronto,  
Ont. *See front fly leaf.***1776—HOUSES—Knock Down.**Rhodes, Curry & Co. Ltd., Amherst, N.S. *Advt. 158.*  
Rathbun (The) Co., Deseronto, Ont. *Advt. p. 162.*  
Edwards, W. C. & Co., Ottawa, Ont. *Advt. page 219.*  
Gravel (The A.) Lumber Co. Ltd., Etchemin, Que.  
*Advt. page 215.***1777—HOUSINGS—Hame, Collar, Saddle.***See No. 1669.***1778—HUBS—(Metal) Bicycle.**Morrow (The John) Machine Screw Co., Ingersoll,  
Ont. *Advt. page 260.***1779—HUBS—(Wood) Wagon.**Chatham Mfg Co. Ltd. Chatham, Ont. *Advt. 245.*  
Christie Bros. & Co., Amherst, N.S. *Advt. page 232.*  
McVean, O. & W., Dresden, Ont.  
Canada Wheel Works, Merritton, Ont.  
Hore's, F. W. Sons, Hamilton, Ont.**1780—HUBS—(Cast Iron) Fire Dept., Truck  
& Engine.**Bateman, Wm., Montreal, Que. *Advt. page 247.***1781—HULLS—Dredge, Steamboat, Steel,  
Vessel.**Matheson, I. & Co., New Glasgow, N. S. *Advt. 200.*  
Carrier, Laine & Co., Levis, Que. *Advt. page 150.*  
Rathbun Co. (The), Deseronto, Ont. *Advt. p. 162.***1782—HULLS—Vessel, (Wood).**Rathbun Co. (The), Deseronto, Ont. *Advt. p. 162.***1783—HULLERS—Clover,**

Sawyer &amp; Massey Co. Ltd., Hamilton, Ont.

**1784—HULLERS & PERLER—Corn, Buck-  
wheat.**Goldie & McCulloch Co. Ltd., Galt, Ont. *Advt. 159.***1785—HURDLES—Wire.**

Greening, B. Wire Co. (Ltd), Hamilton, Ont.

**1786—HYDRANTS—Water Works, "Law's  
Patent."**Central Bridge & Engineering Co. Ltd., Peterboro,  
Ont. *Advt. page 214.***1787—HYDRANTS—Fire, Water Works,  
Yard.**Goldie & McCulloch Co. Ltd., Galt, Ont. *Advt. 159.*  
Garth & Co., Montreal, Que. *Advt. page 154.*  
Ontario Engine & Machine Co. Ltd., Toronto, Ont.  
*Advt. page 177.*McAvity, T. & Sons, St. John, N.B. *Advt. p. 153.*  
Madonald & Co. Ltd., Halifax, N.S. *Advt. p. 256.*  
Carrier, Laine & Co., Levis, Que. *Advt. page 150.*  
Kerr Engine Co. Ltd., Walkerville, Ont. *Advt. 208.*  
Nie & Whitfield, Hamilton, Ont.  
Jenckes Machine Co., Sherbrooke, Que. *Advt. 165.*  
Three Rivers Iron Works, Three Rivers, Que.  
*Advt. page 179.***1788—HYDRASTINE—Alkaloid, Hydrochlo-  
rate, Sulphate, Hydrastinine, Hydro-  
chlorate.**

Parke, Davis &amp; Co., Walkerville, Ont.

**1789—HYPOPHOSPHISES—Hematic.**

Parke, Davis &amp; Co., Walkerville, Ont.

**1790—ICE—Camphor, (Vaseline).**Cheseborough Mfg Co., Montreal, Que. *Advt. p. 259.***1791—IMPORTERS.** *See No. 3860.***1792—INDEXES—Book.**

Mortimer &amp; Co., Ottawa, Ont.

**1793—INDICATORS—(Speed), Elevator, En-  
gine Room.**Hart Emery Wheel Co., Hamilton, Ont. *Advt. p. 166.*  
Kerr & Morgan, Montreal, Que. *Advt. page 220.*  
Robb Engineering Co. Ltd., Amherst, N. S.  
*See inside front cover.*Morrison, (Jas.) Brass Mfg Co., Toronto, Ont.  
*Advt. page 157.*Hamilton Brass Mfg Co., Hamilton, Ont. *Advt. 168.*  
McAvity, T. & Sons, St. John, N.B. *Advt. p. 153.*

Whitney Elec. Instrument Co., Sherbrooke, Que.  
Ness, McLaren & Bate, Montreal, Que. *Advt. p. 240.*

**1794—INHALENTS.**

Parke, Davis & Co., Walkerville, Ont.

**1795—INJECTOR—Syphon.**

Star Iron Co., Montreal, Que.

**1796—INJECTORS—Gresham.**

Morrison Jas. Brass Mfg Co., Toronto, Ont. *Advt. 157.*

**1797—INJECTORS—Air, Steam.**

Earle, S. R., Belleville, Ont. *Advt. page 234.*

**1798—INJECTORS—Boiler.**

Garth & Co., Montreal, Que. *Advt. page 154.*  
Pemberthy Injector Co., Windsor, Ont. *Advt. p. 164.*  
Hamilton Brass Mfg Co., Hamilton, Ont. *Advt. 168.*  
Morrison (Jas.) Brass Mfg Co., Toronto, Ont.  
*Advt. page 157.*  
Robb Engineering Co. Ltd., Amherst, N.S.  
*See inside front cover.*

**1799—INKS—Marking, Typewriting, Writing**

McCrea & Hanes, Toronto, Ont. *Advt. page 248.*  
Edwards, W. C., & Co., Toronto, Ont.  
Underwood, John & Co., Toronto, Ont.

**1800—INKS—Carmine, Copying, Indelible, Lithographing, Printing.**

Ramsay, A. & Son, Montreal, Que. *Advt. page 211.*  
Baylis Mfg Co., Montreal, Que.  
McCrea & Hanes, Toronto, Ont. *Advt. page 248.*  
Underwood, John & Co., Toronto, Ont.

**1801—INSOLES—Electric.**

Dorenwend Electric Belt Co., Toronto, Ont.

**1802—INSOLES—Felt.**

Berlin Felt Boot Co. (The), Berlin, Ont.

**1803—INSOLES—Leather.**

White, R. & Co., Montreal, Que.  
Blouin, Fidèle, Quebec, Que.  
Rochette, C., Quebec, Que.  
Richard & Co., Quebec, Que.

**1804—INSPIRATORS.**

Robb Engineering Co. Ltd., Amherst, N.S.  
*See inside front cover.*

**1805—INSPIRATORS—Hancock.**

Morrison (Jas.) Brass Mfg Co., Toronto, Ont.  
*Advt. page 157.*

**1806—INSTRUMENTS—Surveyors' Meteorological.**

Foster, James, Toronto, Ont.

**1807—INSTRUMENTS—Orthopaedical.**

Dorenwend Electric Belt Co., Toronto, Ont.

**1808—INSTRUMENTS—Cautery "Surgical".**

Ballard Electric Works (The), Toronto, Ont.

**1809—INSTRUMENTS—(Band) Duplex, "Imperial".**

Whaley, Royce Co., Toronto, Ont. *Advt. page 189.*

**1810—INSTRUMENTS—Electrical, Telephone, Telegraph.**

Ness, McLaren & Bate, Montreal, Que. *Advt. p. 240.*

Bell Telephone Co. (The), Montreal, Que.  
Mount Bros., Montreal, Que.  
Toronto Electrical Works, Toronto, Ont.

**1811—INSTRUMENTS MEDICAL—Hypodermic Syringe and Aluminum Case, Indispensable Cup Syringe, Utero Vaginal Syringe, Areometer, Urinary Test Case, Inhaler (Semple's), Capsule Filler, (Acme, Raymond), Bougies.**

Parke, Davis & Co., Walkerville, Ont.

**1812—INSULATORS—Porcelain.**

Canadian General Electric Co. Ltd., Toronto, Ont.  
Peterboro Carbon Co. Ltd., Peterboro, Ont.

**1813—INSULATORS—Glass, Lava, Mica.**

Canadian General Electric Co., Toronto, Ont.

**1814—INTERLINING—Fiberine.**

Ever Ready Dress Stay Co. (The), Windsor, Ont.

**1815—INTURATES.**

Lyman Bros & Co. Ltd., Toronto, Ont.

**1816—INVERTS—Clay Pipe. See Pipe No. 2482.**

**1817—IODIDE OF AMMONIUM—Calcium, Sodium, Mercury, Magnesia.**

Lyman Bros. & Co. Ltd., Toronto, Ont.

**1818—IODINE—Resublimed.**

Canada Chemical Mfg Co. Ltd., London, Ont.  
Lyman, Sons & Co., Montreal, Que.

**1819—IODOFORM.**

Evans and Sons, Ltd., Montreal, Que.  
Lyman, Sons & Co., Montreal, Que.

**1820—IRON—Bar, Carriage Makers', Horse-shoe, Merchant Refined.**

Montreal Rolling Mills Co., Montreal, Que. *Advt. 174.*  
McDonell Rolling Mills Co. (The), Toronto, Ont.  
Abbott & Co., Montreal, Que. *Advt. page 196.*  
Burpee, I. & E. R., St. John, N.B.  
Portland Rolling Mills, St. John, N.B. *Advt. 195.*

**1821—IRON—Galvanized.**

Garth & Co., Montreal, Que. *Advt. page 154.*

**1822—IRON—Pig.**

Canada Iron Furnace Co., Montreal, Que.  
Londonderry Iron Co. Ltd. (The), Montreal, Que.  
Hamilton Iron & Steel Co. Ltd., Hamilton, Ont.  
Guelph Norway Iron & Steel Co., Guelph, Ont.

**1823—IRON—Charcoal Pig.**

Canada Iron Furnace Co., Montreal, Que. *Advt. 206.*  
Pictou Charcoal Iron Co. Ltd., Bridgeville, N. S.  
McDougall, John & Co., Montreal, Que.

**1824—IRON—Sheet.**

Abbott & Co., Montreal, Que. *Advt. page 196.*  
Portland Rolling Mills, St. John, N. B. *Advt. p. 195.*  
Montreal Rolling Mills Co., Montreal, Que. *Advt. 174.*

**1825—IRON—Malleable.**

Malleable Iron Co., Montreal, Que.  
Frost, W. H., Smith's Falls, Ont.  
Kyle, P., Merrickville, Ont.  
Walkerville Malleable Iron Works, Walkerville, Ont.

**1826—IRON—Corrugated, Galvanized.**

*See No. 2856.*

**1827—IRON—Preparations, (Chemical) of.**

Canada Chemical Mfg Co. Ltd., London, Ont.  
Lynan, Bros. & Co., Toronto, Ont.

**1828—IRON—Dialyzed, Glycerated.**

Parke, Davis & Co., Walkerville, Ont.

**1829—IRON—Car Wheel.**

Canada Iron Furnace Co. Ltd., Montreal, Que.  
*Advt. page 206.*

**1830—IRON WARE—Enamelled, Galvanized.**

Kemp Mfg Co., Toronto, Ont.

**1831—IRON STABLE FITTINGS—Stable Salt Dishes, Broom Holders, Box Stall Doors, Flangers, Hay Racks.**

Tisdale Iron Stable Fittings Co., Toronto, Ont.  
*Advt. page 202.*  
Ives, H. R. & Co., Montreal, Que. *Advt. page 200.*  
Smart (Jas.) Mfg Co., Brockville, Ont. *Advt. 178.*

**1832—IRON WORK—(Wrought).**

Dennis, R., London, Ont., *Advt. page 207.*  
Ives, H. R. & Co., Montreal, Que. *Advt. page 200.*  
Toronto Fence & Iron Works, Toronto, Ont.  
Macdonald & Co., Halifax, N.S. *Advt. page 256.*  
Carrier, Laine & Co., Levis, Que. *Advt. page 150.*  
Loignon, A. & E., Montreal, Que. *Advt. page 247.*  
Garth & Co., Montreal, Que. *Advt. page 154.*  
Stratford Bridge & Iron Works, Stratford, Ont.  
*Advt. page 252.*

**1833—IRONS—Tailors.'**

Smart (Jas.) Mfg Co., Brockville, Ont. *Advt. p. 178.*  
Burrow, Stewart & Milne, Hamilton, Ont.

**1834—IRONS—Branding.**

Patterson & Heward, Toronto, Ont. *Advt. p. 201.*  
Pritchard & Andrews, Ottawa, Ont. *Advt. page 250.*  
Macdonald & Co. Ltd., Halifax, N.S. *Advt. p. 256.*

**1835—IRONS—Herbrand Gear.**

Swansea Forging Co. Ltd., Swansea, Ont. *Advt. 156.*

**1836—IRONS—Gear, "Tinkin" Gear, Whiffletree.**

Gillies, Geo. Mfg Co., Gananoque, Ont. *Advt. 156.*

**1837—IRONS—Sad, (Mrs. Potts').**

Woodyatt, A. R. & Co., Guelph, Ont. *Advt. p. 207.*

**1838—IRONS—Deck.**

Carrier, Laine & Co., Levis, Que. *Advt. page 150.*  
Raney, Reid & Selby, Kingston, Ont.

**1839—IRONS—Plane.**

Hay, Peter, Galt, Ont. *Advt. page 234.*

**1840—IRONS—Soldering.**

Brown, Boggs & Co., Hamilton, Ont. *Advt. p. 193.*  
Davidson Mfg Co. (Thos), Montreal, Que. *Advt. 225.*  
McAvity, T. & Sons, St. John, N. B. *Advt. page 153.*

**1841—IRONS—Revolving Cloth Dryer.**

Carrier, Laine & Co., Levis, Que. *Advt. page 150.*  
Woodyatt, A. R. & Co., Guelph, Ont. *Advt. page 207.*  
Wortman & Ward Mfg Co., London, Ont.  
Smart, (Jas.) Mfg Co., Brockville, Ont. *Advt. p. 178.*

**1842—IRONS—Sad Irons, Cold Handle, Laundry, Tailors', Polishing.**

Ives, H. R. & Co., Montreal, Que. *Advt. page 200.*  
Carrier, Laine & Co., Levis, Que. *Advt. page 150.*  
Smart, (Jas.) Mfg Co., Brockville, Ont. *Advt. p. 178.*  
Burrow, Stewart & Milne, Hamilton, Ont.

**1843—IRONS—Tuyere.**

Smart, (Jas.) Mfg Co., Brockville, Ont. *Advt. p. 178.*  
Gurney, Tilden Co. Ltd., Hamilton, Ont. *Advt. 151.*  
Carrier, Laine & Co., Levis, Que. *Advt. page 150.*  
Jardine, A. B. & Co., Hespeler, Ont. *Advt. page 217.*

**1844—IRONS—Derrick. *See Derricks No. 1151.***

**1844 a—IRONS—Derrick.**

Mac Machine Co. Belleville, Ont. *Advt. page 194.*

**1845—IRONS—Clapping.**

Brown Boggs & Co., Hamilton, Ont. *Advt. p. 193.*

**1846—IRONS—Waffle.**

Burrow, Stewart & Milne, Hamilton, Ont.  
Smart, (Jas.) Mfg Co., Brockville, Ont. *Advt. p. 178.*

**1847—JACKS—Log.**

Drake, F. J., Belleville, Ont. *Advt. page 175.*  
Carrier, Laine & Co., Levis, Que. *Advt. page 150.*  
Hamilton, (Wm.) Mfg Co. Ltd., Peterboro, Ont.

**1848—JACKS—Glassing, Pebbling.**

Woon, Robert & Co., Oshawa, Ont. *Advt. page 210.*

**1849—JACKS—Wagon.**

Connor, J. H., Ottawa, Ont.  
Brockville Wringer Co. (The), Brockville, Ont.  
Walker Co'y, (The), Belleville, Ont.

**1850—JACKS—Lifting, Horse Power, Ratchet, Track-Railway.**

Carrier, Laine & Co., Levis, Que. *Advt. page 150.*  
Stewart, John, New Glasgow, N.S. *Advt. page 222.*  
Lancaster Machine Works, Lancaster, Ont. *Advt. 248.*  
Coleman, T. T. (Estate of), Seaforth, Ont.  
Brown (G. & J.) Mfg Co., Belleville, Ont. *Advt. 198.*

**1851—JACKS—Tumbling Rod.**

Sawyer & Massey Co. Ltd., Hamilton, Ont.

**1852—JACKS—Pegging *See No. 2119.***

**1853—JACKS—Boot.**

Ives, H. R. & Co., Montreal, Que. *Advt. page 200.*

**1854—JACKETS, CARDIGAN, TUQUES, JERSEYS, SASHES.**

Turnbull, C. Co. Ltd., Galt, Ont. *Advt. page 203.*  
Forbes (The R.) Co. Ltd. Hespeler, Ont.  
Cartledge, Joseph & Son, Guelph, Ont.  
Universal Knitting Co. Ltd., Toronto, Ont.  
Penman Mfg Co. Ltd., Paris, Ont.  
Burritt, A. & Co., Mitchell, Ont.

**1855—JACKETS—Poro, Plastic.**

Authors & Cox, Toronto, Ont.

**1856—JACKETS—Hose.**

Mitchell, Rob't & Co., Montreal, Que. *Advt. p. 213.*

**1857—JACKETS—(Cork), Life.**

Leckie, J., Toronto, Ont.

**1858—JACKETS—Hunting.**

Hudson Bay Knitting Co., Montreal, Que.

**1859—JAMS—Fruit, Jellies.**

Miller & Co., Trenton, Ont. *Advt. page 236.*  
McCormick Mfg Co. Ltd., London, Ont.  
Miller, A. C. & Co., Picton, Ont. *Advt. page 236.*  
Garden City Canning Co., St. Catharines, Ont.  
Delhi Fruit & Vegetable Canning Co. Delhi, Ont.  
Lefebvre Mitchel & Co., Montreal, Que.  
Toronto Biscuit & Confectionery Co., Toronto, Ont.  
Ontario Pure Food Co., St. Catharines, Ont.  
Patterson, S. & Co., Toronto, Ont.  
Lytle, T. A. & Co., Toronto, Ont.  
Lakeport Preserving Co., Trenton, Ont.  
Hamilton Vinegar Works, Hamilton, Ont.

**1860—JAPANS—Gold Size.** *See No. 3635.***1861—JARDINIÈRES—Bamboo.**

Gendron Mfg Co. Ltd., Toronto, Ont. *Advt. p. 187.*  
Thompson, Alex. & Co., Hamilton, Ont.  
Cobban Mfg Co. Ltd., Toronto, Ont.

**1862—JARS—(Stoneware), Jam, Fruit, Pickle**

Brantford Stoneware Mfg Co. Ltd., Brantford, Ont.  
*Advt. page 251.*  
Campbell, R., Hamilton, Ont. *Advt. page 230.*

**1863—JARS—(Glass), Confectioners', Honey.**

Lamont Glass Co., New Glasgow, N.S. *Advt. p. 231.*  
Dominion Glass Works, Montreal, Que. *Advt. p. 221.*  
Toronto Glass Co. Ltd., Toronto, Ont.

**1864—JELLSTONE.**

Alabastine Co. Ltd. (The), Paris, Ont. *Advt. page 212.*

**1865—JELLY—Melrose, (Skin Preparation).**

Domestic Specialty Co., Hamilton, Ont. *Advt. 227.*

**1866—JEWELRY—Diamond, Gold, Silver.**

Dominion Rolled Plate Co., Montreal, Que. *Advt. 236.*  
Saunders, H. & A., Toronto, Ont.  
Bramley, William, Montreal, Que. *Advt. page 236.*  
Ellis, P. W. & Co., Toronto, Ont.

**1867—JEWELS—Regalia, Society.**

Saunders, H. A. & Co., Toronto, Ont.  
Bramley, William, Montreal, Que. *Advt. page 236.*  
Dewdney, A. H. & Bro., Toronto, Ont.  
Ellis, P. W. & Co., Toronto, Ont.  
White, J. C., Hamilton, Ont.

**1868—JOINTS—(Flexible) Water Pipe, Law's Patent.**

Central Bridge & Engineering Co. Ltd., Peterboro, Ont. *Advt. page 214.*

**1869—JOINTS—Gas Pipe.**

Morrison, (Jas.) Brass Mfg Co., Toronto, Ont.  
*Advt. page 157.*

**1870—JOINTS—Concealed, Stump.**

Swansea Forging Co. Ltd., Swansea, Ont. *Advt. 156.*  
Gillies George (The Co.), Gananoque, Ont. *Advt. 156.*

**1871—JOINTS—Expansion, Pipe.**

Macdonald & Co. Ltd., Halifax, N.S. *Advt. p. 256.*  
Morrison (Jas.) Brass Mfg Co., Toronto, Ont.  
*Advt. page 157,*  
Garth & Co., Montreal, Que. *Advt. page 154.*

Carrier, Laine & Co., Levis, Que. *Advt. page 150.*  
Lessard & Harris, Montreal, Que. *Advt. page 231.*  
Kyle, P., Merrickville, Ont.  
Gillies Geo. Co. (The), Gananoque, Ont. *Advt. 156.*

**1872—JOINTERS—Plover.** *See No. 2591.***1873—JOINTERS—Planer.**

Sleeper & Akhurst, Coaticook, Que. *Advt. p. 241.*

**1874—JOINTERS—Gang Saw, (Automatic).**

Ballantine, John & Co., Preston, Ont. *Advt. p. 205.*

**1875—JOINTERS—Stave, Heading.**

Goldie & McCulloch Co. Ltd., Galt, Ont. *Advt. 159.*  
McKeough & Trotter, Chatham, Ont.  
Lloyd Mfg Co., Kentville, N.S.  
Park Bros., Chatham, Ont.

**1876—JOINTERS—Shingle.**

Canada Locomotive & Engine Works, Kingston, Ont. *Advt. page 175.*

**1877—JOURNALS—Book Keeping.**

*See Blank Books No. 384.*

**1878—JUICE—Lime.**

Brown & Webb, Halifax, N.S.  
Turner, Robert, Toronto, Ont.  
Evans and Sons Co., Montreal, Que.  
Simson, Bros. & Co., Halifax, N.S.

**1879—JUICE—Lime, & Pepsin.**

Parke, Davis & Co., Walkerville, Ont.

**1880—JUICE—Unfermented Grape.**

Pele Island Wine & Vinegar Co., Brantford, Ont.  
Hagar Bros., Welland, Ont.

**1881—JUICES—Fruit.**

Seely Mfg Co., Windsor, Ont.

**1882—JUGS.**

Campbell, R., Hamilton, Ont. *Advt. page 230.*  
Brantford Stoneware Mfg Co. Ltd. (The), Brantford, Ont. *Advt. page 251.*  
Hart Bros. & Lazier, Belleville, Ont. *Advt. page 230.*  
Farrar, E. L., Iberville, Que.  
Glass Bros. & Co., London, Ont.

**1883—JUMPERS—Cotton.**

Goodhue, J. L., Rock Island, Que. *Advt. page 236.*

**1884—JUMPERS—Baby.**

Gendron Mfg Co. Ltd., Toronto, Ont. *Advt. page 187.*  
Wesley, F. J. & Co., Toronto Junction, Ont.

**1885—KALSOMINES.**

Alabastine Co. Ltd. (The), Paris, Ont. *Advt. p. 212.*  
Canada Paint Co. Ltd., Montreal, Que. *Advt. p. 221.*

**1886—K. D. C.**

K. D. C. Medicine Co., New Glasgow, N.S.

**1887—KEELERS—Cedar.** *See No. 2375.***1888—KEGS—Tack.**

Hope, John & Co., Lachute Mills, Que. *Advt. p. 188.*  
Thompson & Co., Sherbrooke, Que.

**1889—KEGS—Pickle & Beer.**

Lendreville, J., Toronto, Ont.

**1890—KEGS—Powder, Nail.**

Magee Mfg Co. Ltd., London, Ont.

**1891—KETTLES—Patent Dome Bottom.**

Booth Copper Co., Toronto, Ont. *Advt. page 155.*  
Collins Mfg Co., Toronto, Ont.

**1892—KETTLES—(Cast Iron), Acid, Farmers', Potash, Scalding, Soap, Swing, Tanners', Caldrons'.** *See No. 2593.*

**1893—KETTLE—Brass, Copper, Range, Stove.**

Carrier, Laine & Co., Levis, Que. *Advt. page 150.*  
American Copper Co., Toronto, Ont. *Advt. page 157.*  
Booth-Copper Co., Toronto, Ont. *Advt. page 155.*  
Chadwick Bros., Hamilton, Ont. *Advt. page 206.*  
Gurney, Tilden Co. Ltd., Hamilton, Ont. *Advt. 151.*  
Smart (James) Mfg Co., Brockville, Ont. *Advt. 178.*  
Parker, J. O. & Co., Toronto, Ont. *Advt. page 253.*  
Davidson Mfg Co. (Thos.), Montreal, Que. *Advt. 225.*  
Kemp Mfg Co., Toronto, Ont.

**1894—KETTLES—(Copper), Acid, Brewers', Color, Confectioners', Jacket, Sugar Varnish.**

Booth Copper Co., Toronto, Ont. *Advt. page 155.*  
Coulter & Campbell, Toronto, Ont. *Advt. page 201.*  
Chadwick Bros., Hamilton, Ont. *Advt. page 206.*  
Macdonald & Co. Ltd., Halifax, N. S. *Advt. p. 256.*  
Carrier, Laine & Co., Levis Que. *Advt. page 150.*  
Parker, J. O. & Co., Toronto, Ont. *Advt. page 253.*  
Garth & Co. Montreal, Que. *Advt. page 154.*

**1895—KEYS—Telegraph.**

Ness, McLaren & Bate, Montreal, Que. *Advt. p. 240.*

**1896—KEYS—Organ,**

Newell, Aug. & Co., Toronto, Ont.  
Loose, Joseph M. Toronto, Ont.

**1897—KEYS—Door.** *See Locks No. 2028.*

**1898—KEYS—Spring.**

Dominion Wire Mfg Co., Montreal, Que. *Advt. 176.*  
Whitman & Barnes Mfg Co., St. Catharines, Ont.

**1899—KIDNEYWORT.**

Wells & Richardson Co., Montreal, Que.

**1900—KINDERGARTEN—Books & Materials.**

Selby & Co., Toronto, Ont.

**1901—KNIVES—Wood Working (Machine), Planer, Shingle, Veneer, Matcher.**

Hay, Peter, Galt, Ont. *Advt. page 234.*  
Whitman & Barnes Mfg Co., St. Catharines, Ont.

**1902—KNIVES—Upright Hay, "Heath's Patent." See No. 2950.**

**1903—KNIVES—Curd.**

Chown, W. W. & Co., Belleville, Ont. *Advt. p. 233.*  
Richardson & Webster, St. Mary's, Ont.  
Lancaster Machine Works, Lancaster, Ont. *Advt. 248.*

**1904—KNIVES—Tobacco.**

Smart (James) Mfg Co., Brockville, Ont. *Advt. 178.*  
Whitman & Barnes Mfg Co., St. Catharines, Ont.  
Warnock, James & Co., Galt, Ont.

**1905—KNIVES—Honey.**

Snowden, Wm., Peterborough, Ont.

Goold, Shapley & Muir Co., Brantford, Ont.

*Advt. page 191.*

Bussell, W. G., Millbrook, Ont.

**1906—KNIVES—Straw Cutter.**

James Robertson Co., (The), Toronto. *Advt. page 167.*

**1907—KNIVES—Mincing.**

Smart, (Jas.) Mfg Co., Brockville, Ont. *Advt. p. 178.*

**1908—KNIVES—Bookbinders', Chipper, Implement, Mower, Tenoning.**

Whitman & Barnes Mfg Co., St Catharines, Ont.

**1909—KNIVES—Leather Splitting, Carving.**

Hay, Peter, Galt, Ont. *Advt. page 234.*

**1910—KNIVES—Paper Cutter.**

Robb Engineering Co. Ltd., Amberst, N. S.

*See inside front cover.*

Whitman & Barnes Mfg Co., St. Catharines, Ont.

**1911—KNIVES—Sterling Silver.** *See No. 3092.*

**1912—KNIVES—(Plated), Fruit, Table.** *See No. 3092.*

**1913—KNIVES—Cultivator.**

Chalifoux, O. & Sons, St. Hyacinthe, Que. *Advt. 232.*

**1914—KNIT GOODS—(Fancy) Clouds, Caps, Hoods,**

Universal Knitting Co., Toronto, Ont.  
Burritt, S. & Co., Mitchell, Ont.  
Forbes Co. Ltd. (The R.), Hespeler, Ont.  
Granite Mills, St. Hyacinthe, Que.  
Penman Mfg Co. Ltd., Paris, Ont.

**1915—KNOBS—(Wood) Base, Carved, Walnut**

Goulette, O. V., Gananoque, Ont. *Advt. page 214.*  
Wesley, F. J. & Co., Toronto Junction, Ont.

**1916—KNOBS—Brass Bedsteads, Metal Stove, Spun.**

Chadwick Bros., Hamilton, Ont. *Advt. page 206.*

**1917—KNOBS—(Door), Stove, Stove Slide.**

Paris Electro Plating Co., Paris Station, Ont.

**1918—KNOBS—Bronze Shutter, Key, Picture, Porcelain.**

Peterboro Lock Mfg Co., Peterboro, Ont. *Advt. 219.*  
McDonald & Allen, Kingston, Ont. *Advt. page 257.*

**1919—KNOCKERS—Door.**

Garth & Co., Montreal, Que. *Advt. page 154.*  
Peterboro Lock Mfg Co., Peterboro, Ont. *Advt. 219.*

**1920—KOLA NUTS—Kolavin (Preparation of)**

Stearns, Fred'k & Co., Windsor, Ont. *See back cover.*

**1921—LABELS—Brass.** *See Checks No. 786.*

**1922—LACE—Bed.**

Hamilton Cotton Co., Hamilton, Ont. *Advt. p. 188.*

**1923—LACES—Corset.**

Cascade, Narrow Fabric Co., Coaticook, Que. *Advt. page 188.*

**1924—LACING—Belt, Leather, Rawhide.**

*See No. 1961.*

**1925—LACQUERS.** *See Varnishes No. 3636.*

**1926—LADDERS—Bicycle Step, Bicycle Shelf.**

Hamilton Brass Mfg Co., Hamilton, Ont. *Advt.* 168.  
Dennis, R., London, Ont. *Advt.* page 207.

**1927—LADDERS—Extension, Farm, Folding, Painters', Safety, Step.**

Laing, Ritchie & Co., Essex, Ont. *Advt.* page 209.  
Otterville Mfg Co. Ltd., Otterville, Ont. *Advt.* 259.  
McFarlane, George, Toronto, Ont.

**1928—LADLES—Butter.** *See No.* 2641.

**1929—LADLES—Foundry, Melting, Plumb-ers'.**

Matheson, I. & Co., New Glasgow, N.S. *Advt.* 200.  
Carrier, Laine & Co., Levis, Que. *Advt.* page 150.  
Woodyatt, A. R. & Co., Guelph, Ont. *Advt.* p 207.

**1930—LAMPS—Electric, Arc.**

Packhard Electric Co., St. Catharines, Ont. *Advt.* 239.  
Royal Electric Co., Montreal, Que.

**1931—LAMPS—Brazing.**

Hart Emery Wheel Co., Hamilton, Ont. *Advt.* 166.

**1932—LAMPS—Glass.**

Lamont Glass Co., New Glasgow, N.S. *Advt.* 231.  
Dominion Glass Works, Montreal, Que. *Advt.* 221,

**1933—LAMPS—Hanging, Metal Figure, Metal Stand, Newel Post, Piano, Pulpit, Street.**

Garth & Co., Montreal, Que. *Advt.* page 154.  
Dominion Tubular Lamp Co., Montreal, Que.  
Young & Bro. Co. Ltd., Hamilton, Ont. *Advt.* 257.  
Chadwick Bros., Hamilton, Ont. *Advt.* page 206.  
American Copper Co., Toronto, Ont. *Advt.* page 157.  
Mitchell, Robt. & Co., Montreal, Que. *Advt.* p. 213.

**1934—LAMPS—(Tin), Binnacle, Caboose, Dash, Head Light, Locomotive, Miners', Marine, Railroad.**

Davidson Mfg Co. (Thos.), Montreal, Que. *Advt.* 225.  
Chadwick Bros., Hamilton, Ont. *Advt.* page 206.  
Chown, W. W. & Co., Belleville, Ont. *Advt.* p. 233.  
Dominion Tubular Lamp Co., Montreal, Que.  
Kemp Mfg Co., Toronto, Ont.

**1935—LAMPS—Bicycle.**

Goold Bicycle Co. Ltd., Brantford, Ont. *Advt.* 220.

**1936—LAMPS—Regenerative Gas, Fishing.**

Mitchell, Robt. & Co., Montreal, Que. *Advt.* p. 213.

**1937—LANTERNS—Bull's Eye.**

*See Tin Lamps No.* 1934.

**1938—LANTERNS—(Brass), Conductor, Firemen's.**

Chadwick Bros., Hamilton, Ont. *Advt.* page 206.  
Mitchell, Robt. & Co., Montreal, Que. *Advt.* p. 213.  
Dominion Tubular Lamp Co., Montreal, Que.  
Piper, Noah L. & Son, Toronto, Ont.

**1939—LAPPERS—Hoop.**

McKeough & Trotter, Chatham, Ont.  
Park Bros., Chatham, Ont.

**1940—LARIGANS—Oil Tanned.** *See No.* 2225.

**1941—LASTS—Boot & Shoe.**

Chalifoux, O., Quebec, Que. *Advt.* page 232.  
Lewis, J. & Son, Truro, N. S.

Clerke, James & Son, St. John, N. B.  
Dunham, W. A., Montreal, Que.  
Iredale, John C. & Co., Toronto, Ont.  
Bullock & Coleman, Lyn, Ont.

**1942—LATCHES—(Iron), Sliding Door.**

*See No.* 1658.

**1943—LATH—Expanded Metal, Fireproof.**

*See No.* 2856.

**1944—LATHES—Polishing.**

Hart Emery Wheel Co. Hamilton, Ont. *Advt.* 166.

**1945—LATHES—Car & Driving Wheel, Break, Speed, Tire.**

Bertram, John & Sons, Dundas, Ont. *Advt.* p. 161.  
Gardner R. & Sons, Montreal, Que.

**1946—LATHES—Beading, Bobbin, Gauge, Wood Turning, Hub, Last, Neck Yoke, Variety.**

Ballantine, John & Co. Preston, Ont. *Advt.* p. 205.  
Goldie & McCulloch Co., Galt, Ont. *Advt.* p. 159.  
Robb Engineering Co. Ltd., Amherst, N. S.

*See inside front cover.*

Macgregor, Gourlay & Co., Galt, Ont.

Cant Bros. Co. Ltd., Galt, Ont. *Advt.* page 259.

**1947—LATHES—Chair Makers', Pattern Makers'.** *See No.* 1946.

**1948—LATHES—Axle, Bench, Bolt, Brass Finishers', Crank Pin, Cutting off, Chucking, Drill, Engine, Gap, Grinding, Monitor, Pulley Boring & Turning, Screw Cutting, Turret.**

Bertram, John & Sons, Dundas, Ont. *Advt.* p. 161.  
Stevens, Hamilton & Co., Galt, Ont.  
Gardner, Robt. & Sons, Montreal, Que.

**1949—LATHES.** *See No.* 1948.

**1950—LAUNCHES—Steam.**

Matheson, I. & Co., New Glasgow, N.S. *Advt.* 200.  
Bertram Engine Works Co. Ltd., Toronto, Ont.

**1951—LEAD—White (In Oil).**

McArthur, Corneille & Co., Montreal, Que. *Advt.* 221.

**1952—LEAD—Chloride, Nitrate, Sulphate.**

Canada Chemical Mfg Co. Ltd., London, Ont.

**1953—LEAD—Sheet.**

Montreal Rolling Mills Co., Montreal, Que.

*Advt.* page 174.

Robertson Co. (James), Toronto, Ont. *Advt.* 167.

**1954—LEAD—Bar, Pig, Sash.**

Montreal Rolling Mills Co., Montreal, Que.

*Advt.* page 174.

Toronto Smelting & Refining Works, Toronto, Ont.

*Advt.* page 255.

Robertson Co. Ltd. (Jas.), Toronto, Ont. *Advt.* 167.

Young & Bro. Co. Ltd., Hamilton, Ont. *Advt.* 257.

Ontario Lead & Barb Wire Co., Toronto, Ont.

*Advt.* page 177.

**1955—LEAD—Red, White.**

Canada Paint Co., Montreal, Que. *Advt.* page 221.

Ramsay, A. & Son, Montreal, Que. *Advt.* page 211.

Henderson & Potts, Halifax, N. S.



- Montreal Rolling Mills Co., Montreal, Que.  
*Advt. page 174.*
- Ontario Lead & Barb Wire Co. Ltd., Toronto, Ont.  
*Advt. page 177.*
- Robertson Co. Ltd., (Jas.), Toronto, Ont. Montreal,  
Que. Winnipeg, Man. St. John, N.B. *Advt. p. 167.*
- Howe, William, Ottawa, Ont. *Advt. page 201.*
- 1956—LEAD—Black.**  
Tellier, Rothwell & Co., Montreal, Que.  
Pure Gold Mfg Co., Toronto, Ont.  
Ralston, R. & Co., Hamilton, Ont.
- 1957—LEADS—Printers'.**  
National Elec. & Stereotype Co., Toronto, Ont.
- 1958—LEADS—Piano.**  
Coulter & Campbell, Toronto, Ont. *Advt. page 201.*
- 1959—LEADERS—Cattle.**  
Woodyatt, A. R. & Co., Guelph, Ont. *Advt. p. 207.*
- 1960—LEAF—Gold.**  
Hubbard, C. H., Toronto, Ont.
- 1961—LEATHER—Belting, Lace, Picker.**  
Robin, Sadler & Haworth, Montreal, Que. *Advt. 226.*  
McClaren Belting Co., (The J. C.), Montreal, Que.  
Porter, Henry, Montreal, Que. *Advt. page 239.*  
Goodhue, J. L. & Co., Danville, Que. *Advt. p. 236.*
- 1962—LEATHER—"Oil Dressed Indian Tan."**  
Hall, James & Co., Brockville, Ont. *Advt. page 227.*
- 1963—LEATHER—Beef Moccasin.** *See No. 2225.*
- 1964—LEATHER—Glazed, Imitation Cham-  
mois, Kangaroo.**  
Clarke, A. R. & Co., Toronto, Ont.
- 1965—LEATHER—Porpoise, Russian Calf.**  
Porter, Henry, Montreal, Que. *Advt. page 239.*
- 1966—LEATHER—Embossed & Illuminated.**  
Craig, Wm. & Sons, Port Hope, Ont.  
Porter, Henry, Montreal, Que. *Advt. page 239.*  
Clarke, A. R. & Co., Toronto, Ont.  
Peters, Chas. H., St. John, N.B.
- 1967—LEATHER—Buckskin, Calf, Goat, Kid,  
Morocco, Sheepskin.**  
Hall, James & Co., Brockville, Ont. *Advt. page 227.*  
Fisk, H. J. & Co., Montreal & Quebec, Que.  
Pion, A. & Co., Quebec, Que.  
Bell & Co., Tilsonburg, Ont.  
Clark, A. R. & Co., Toronto, Ont.  
Chapman, W. J., Wingham, Ont. *Advt. page 227.*  
Storey, W. H. & Son, Acton, Ont.
- 1968—LEATHER—Bellows, Carriage Dash,  
Shaft.**  
Porter, Henry, Montreal, Que. *Advt. page 239.*  
Montreal Carriage Leather Co., Montreal, Que.  
Peters, Chas. H., St. John, N.B.  
Bickell & Wickett, Toronto, Ont.
- 1969—LEATHER—Sole.**  
Porter, Henry, Montreal, Que. *Advt. page 239.*  
Peters, Chas. H., St. John, N.B.  
Rochette, Gaspard, Quebec, Que.  
Shaw, Cassils & Co., Montreal, Que.

- Hyman, C. S. & Co., London, Ont.  
Breithaupt Leather Co. Ltd., Berlin, Ont.
- 1970—LEATHER—Bag, Bookbinders', Don-  
gola.** *See Leather No. 1972.*
- 1971—LEATHER—Patent.**  
Porter, Henry, Montreal, Que. *Advt. page 239.*  
Peters, Chas. H., St. John, N. B.  
Montreal Carriage Leather Co., Montreal, Que.  
Falardeau, P. E. & Co., Quebec, Que.  
Bresse, G. & Co., Quebec, Que.
- 1972—LEATHER—Fancy, Pebbled, Split,  
Upholstery.**  
Fisk, H. J. & Co., Quebec, Que.  
Clarke, A. R. & Co., Toronto, Ont.  
Peters, Chas. H., St. John, N. B.  
Craig, Wm. & Sons, Port Hope, Ont.  
Bickell & Wickett, Toronto, Ont.  
Porter, Henry, Montreal, Que. *Advt. page 239.*
- 1973—LEATHER—Grain, Harness, Sadlery,  
Upper.**  
Porter, Henry, Montreal, Que. *Advt. page 239.*  
Craig, Wm. & Son, Port Hope, Ont.  
Carrington, Joseph, Kingston, Ont.  
Breithaupt Leather Co., Berlin, Ont.  
Bickell & Wickett, Toronto, Ont.  
Peters, Chas. H., St. John, N.B.  
Lisle, Alfred, Lindsay, Ont.  
Bell & Co., Tilsonburg, Ont.
- 1974—LEATHER—Standard Oak Lace.**  
Bell & Co., Tilsonburg, Ont.
- 1975—LECTURNS—Brass.**  
American Copper Co. (The), Toronto, Ont. *Advt. 157.*  
Dennis, R., London, Ont. *Advt. page 207.*
- 1976—LEGGINS—Rubber.** *See No. 3056.*
- 1977—LEGGINS—Leather.**  
Chapman, W. J., Teeswater, Ont.  
American Overgaiter Co. (The), Toronto, Ont.  
Packard, L. H. & Co., Montreal, Que.
- 1978—LEGS—Piano Stool.** *See No. 3307.*
- 1979—LENSES—Glass.**  
Lamont Glass Co., New Glasgow, N.S. *Advt. 231.*  
Diamond Glass Works, Montreal, Que.
- 1980—LETTERS—Brilliant Sign, Enamel.**  
Brilliant Sign Letter Co. (The), Toronto, Ont.
- 1981—LETTERS—Brass, Copper, Steel.**  
Pritchard & Andrews, Ottawa, Ont. *Advt. page 250.*  
Patterson & Heward, Toronto, Ont. *Advt. page 201.*  
Mitchell, Robert & Co., Montreal, Que. *Advt. 213.*  
Lane, William & Co., Montreal, Que.  
Hill, H. A., Montreal, Que.
- 1982—LETTERS—Wooden.**  
Thackray, Robert, Ottawa, Ont.
- 1983—LEVELS—Surveyors' (Dump & Y.).**  
*See No. 1806.*
- 1984—LEVERS—Cistern.**  
Ives, H. R. & Co., Montreal, Que. *Advt. page 200.*
- 1985—LIDS—Box, Journal.** *See No. 419.*

**1986—LIFTERS—Wire Plate.**

Davidson Mfg Co. (Thomas), Montreal, Que. *Advt. page 225.*  
Dennis, R., London, Ont. *Advt. page 207.*

**1987—LIFTS—(Iron), Sash. See No. 1658.****1988—LIGHTERS—(Veneer), Cigar.**

Kean, Frank, Orillia, Ont. *Advt. page 217.*  
Fitch Edson Co. (The), Etchemin, Que.

**1989—LIGHTERS—Jet, Extinguishers.**

Mitchell, Rob't & Co., Montreal, Que. *Advt. 213.*  
Morrison, (Jas.) Brass Mfg Co., Toronto, Ont. *Advt. page 157.*

**1990—LIGHTS—Ship, Deck & Side.**

McAvity, T. & Sons, St. John, N.B. *Advt. page 153.*  
Mitchell, Robt. & Co., Montreal, Que. *Advt. 213.*  
Morrison (Jas.) Brass Mfg Co., Toronto, Ont. *Advt. 157.*  
Macdonald & Co. Ltd., Halifax, N.S. *Advt. p. 256.*

**1991—LIGHTS—Carriage Curtain.**

McKinnon Dash & Hardware Co., St. Catharines, Ont. *Advt. page 202.*

**1992—LIGHTS—Electric Search.**

Royal Electric Co., Montreal, Que.

**1993—LIGHTS—(Head), Electric Car, Locomotive.**

American Copper Co. (The), Toronto, Ont. *Advt. 157.*  
Chadwick Bros., Hamilton, Ont. *Advt. page 206.*  
Mitchell, Robt. & Co., Montreal, Que. *Advt. p. 213.*  
Piper, Noah L. & Son, Toronto, Ont.

**1994—LIMBS—Artificial.**

Grose, F. Montreal, Que.  
Authors & Cox, Toronto, Ont.

**1995—LIME—Gray, Plastering, White.**

Rathbun Co. (The), Deseronto, Ont. *Advt. p. 162.*  
Miller, Charles, St. John, N.B.  
Harvey, E., Guelph, Ont.  
Dominion Lime Co., Sherbrooke, Que.  
Christie, Henderson & Co., Acton, Ont.  
Kennedy, D. & Son, Guelph, Ont.  
Purdy & Green, St. John, N.B.  
Bras D'Or Lime Co., Ltd. (The), Halifax, N.S.  
Montreal Lime Co., Montreal, Que.  
Toronto Lime Co., Lime House, Ont.

**1995 a—LIME—Acetate of. See Acetate No. 1.****1996—LINES—(Clothes), "Spiral" Wire.**

LeBarron, G. A., Sherbrooke, Que.

**1997—LINES—Clothes, (Wire).**

Dominion Wire Rope Co., Montreal, Que. *Advt. 171.*

**1998—LINES—Awning, Chalk, Cotton Clothes Deep Sea Fish. See No. 3598,****1999—LINIMENT—Alpine, (Sharpe's).**

Armstrong & Co., St. John, N.B. *Advt. page 229.*

**2000—LINIMENT—"Simpsons".**

Brown & Webb, Halifax, N.S.

**2001—LINIMENT—Household.**

McCrea & Hanes, Toronto, Ont. *Advt. page 248.*

Richards, C. C., Yarmouth, N.S.  
Lyman, Sons & Co., Montreal, Que.

**2002—LININGS—Casket.**

Christie, Bros. & Co., Amherst, N.S. *Advt. p. 232.*  
Thompson, D. W. & Co., Toronto, Ont.  
Globe Casket Co., London, Ont.

**2003—LININGS—Cotton Printed.**

Dominion Cotton Mills Co. Ltd., Montreal, Que. *Advt. page 181.*

**2004—LININGS—Mattress.**

Dominion Wadding Co. Ltd., Montreal, Que. *Advt. page 183.*

**2005—LININGS—Fire Place, Grate, Heating Apparatus, Stove.**

Ives, H. R. & Co., Montreal, Que. *Advt. page 200.*  
Campbell, R., Hamilton, Ont. *Advt. page 230.*  
Gurney, Tilden Co. Ltd., Hamilton, Ont. *Advt. 151.*

**2006—LININGS—(Asbestos), Stove.**

Sclater Asbestos Co., Montreal, Que. *Advt. page 172.*  
Forrester, Thos., Montreal, Que. *See front fly leaf.*

**2007—LINING—Patent Folded.**

Lazier, S. A., Belleville, Ont. *Advt. page 190.*

**2008—LINING—(Skirt), Hair Cloth.**

Canada Hair Cloth Co., St. Catharines, Ont.

**2009—LININGS—Flue.**

Standard Drain Pipe Co., St. Johns, Que. *Advt. p. 251.*

**2010—LINING—Carpet, Floor.**

Lazier, S. A., Belleville, Ont. *Advt. page 190.*  
McArthur, Alex. & Co., Montreal, Que. *Advt. 224.*  
Mealey, Thomas & Co., Hamilton, Ont. *Advt. p. 185.*

**2011—LINING—Wadded Carpet.**

Mealey, Thomas & Co., Hamilton, Ont. *Advt. 185.*

**2012—LINTELS—Stone. See No. 2235.****2013—LINTELS—(Iron), "Door & Window Sills".**

Fleck, Alex., Jr., Ottawa, Ont. *Advt. page 252.*  
Loignon, A. & E., Montreal, Que. *Advt. page 247.*  
Parker, Moses, Montreal, Que. *Advt. page 197.*

**2014—LIQUIDS—Normal, Antiseptic.**

Parke, Davis & Co., Walkerville, Ont.

**2015—LIQUOR—Red.**

Canada Chemical Mfg Co. Ltd., London, Ont.

**2016—LIQUOR—Iron, (Black).**

Montreal Chemical Works, Montreal, Que.

**2017—LIQUOR—Iron.**

Lyman Sons & Co., Montreal, Que.  
Montreal Chemical Works, Montreal, Que.

**2018—LIQUOR—Sedans.**

Parke, Davis & Co., Walkerville, Ont.

**2019—LITHOGRAPHING—Commercial, Color, Photo.**

Dominion Engraving Co., Ottawa, Ont. *Advt. 186.*  
Doust, Joseph, Toronto, Ont. *Advt. page 229.*  
Mortimer & Co., Ottawa, Ont.

Barclay, Clark & Co., Toronto, Ont.  
Rolph, Smith & Co., Toronto, Ont.  
Toronto Lithographing Co., Toronto, Ont.  
Marine Steam Lithograph Co., St. John, N. B.

**2020—LOADERS—Grain Car, "Elevator".**

Miller Bros. & Toms, Montreal, Que. *Advt. p. 197.*  
Kerr & Morgan, Montreal, Que. *Advt. page 220.*  
Hamilton Mfg Co. Ltd. (Wm.), Peterboro, Ont.  
Goldie & McCulloch Co. Ltd., Galt, Ont. *Advt. 159.*

**2021—LOADERS—Hay.**

Waterloo Mfg Co. Ltd., Waterloo, Ont. *Advt. p. 218.*  
Maxwell, David & Sons, St. Mary's Ont. *Advt. 250.*

**2022—LOCKETS—Gold. See No. 1866.**

**2023—LOCKS—Latch, Lever, Refrigerator, Sash, Sliding Door.**

Gurney, Tilden Co. Ltd., Hamilton, Ont. *Advt. 151.*  
Cooke Hardware Co., Hamilton, Ont. *Advt. page 166.*  
Peterboro Lock Mfg Co., Peterboro, Ont. *Advt. 219.*  
Woodyatt, A. R. & Co., Guelph, Ont. *Advt. p. 207.*

**2024—LOCKS—Patent, Safety Door, Transon.**

St. Lawrence Steel & Wire Co. Ltd., Gananoque, Ont. *Advt. page 183.*

**2025—LOCKS—Burglar Proof, Safe.**

Goldie & McCulloch Co. Ltd., Galt, Ont. *Advt. 159.*

**2026—LOCKS—Hasp.**

Cowan & Britton, Gananoque, Ont.

**2027—LOCKS—Oar, Row.**

Burrow, Stewart & Milne, Hamilton, Ont.  
Smart, (Jas.) Mfg Co., Brockville, Ont. *Advt. p. 178.*  
Frost, W. H., Smith's Falls, Ont.  
Kyle, P., Merrickville, Ont.  
Macdonald & Co. Ltd., Halifax, N. S. *Advt. p. 256.*

**2028—LOCKS & LATCHES—Cabinet, Dead, Keyless, Knob, Mortise, Padlock, Post Office, Sewing Machine, Spring, Trunk.**

Gurney, Tilden Co. Ltd., Hamilton, Ont. *Advt. 151.*  
Peterboro Lock Mfg Co., Peterboro, Ont. *Advt. 219.*

**2029—LOCOMOTIVES—Heavy, Light, Logging, Mine, Parts.**

Canadian Locomotive & Engine Co. Ltd., Kingston, Ont. *Advt. page 175.*  
Rathbun Co. (The), Deseronto, Ont. *Advt. p. 162.*

**2030—LOOMS—Cotton & Woolen Mill.**

Bateman, Wm. & Co., Montreal, Que. *Advt. page 247.*

**2031—LOOPS—Ladies' Jacket.**

Moulton & Co., Montreal, Que.

**2032—LOOPS—Body, Carriage.**

Swansea Forging Co. Ltd., Swansea, Ont. *Advt. 156.*

**2033—LOOPS—Hame.**

Skinner & Co., Gananoque, Ont. *Advt. page 255.*  
Kyle, P., Merrickville, Ont.

**2034—LOOPS—Box, (Leather).**

*See Harness No. 1669.*

**2035—LOOPS—Buckle, (Metal).**

Mckinnon Dash & Hardware Co., St. Catharines, Ont. *Advt. page 202.*

**2036—LOZENGES—Compressed Medicated.**

Stearns, Fred'k & Co., Windsor, Ont. *See back cover.*  
Parke, Davis & Co., Walkerville, Ont.  
McCormick Mfg Co. Ltd., London, Ont.  
Ganong Bros. Ltd., St. Stephen, N. B.  
Lyman Bros. & Co. Ltd., Toronto, Ont.  
Watson, R. & T., Toronto, Ont.

**2037—LUBRICATORS—Car Axle.**

Vessot, S. & Co., Joliette, Que. *Advt. page 238.*

**2038—LUBRICATORS—Self Piston, (Pat.) Self Valve, Reed, (Pat.).**

Emond, V. A., Quebec, Que.

**2039—LUBRICATORS—Adjustable, Centrifugal, Cilynder, Dynamo, Sight Feed.**

Garth & Co., Montreal, Que. *Advt. page 154.*  
McDonald & Co. Ltd., Halifax, N. S. *Advt. p. 256.*  
Mitchell, Rob't & Co., Montreal, Que. *Advt. p. 213.*  
McAvity, T. & Sons, St. John, N. B. *Advt. p. 153.*  
Morrison Brass Mfg Co., Toronto, Ont. *Advt. p. 157.*  
Hamilton Brass Mfg Co., Hamilton, Ont. *Advt. 168.*  
Robb Engineering Co. Ltd., Amherst, N. S. *See inside front cover.*

Penberthy Injector Co., Windsor, Ont. *Advt. p. 164.*  
Jenckes Machine Co., Sherbrooke, Que. *Advt. 165.*  
Parker, J. O. & Co., Toronto, Ont. *Advt. page 253.*

**2040—LYE—Concentrated,**

Gillett, E. W., Toronto, Ont.

**2041—LUMBER—Dressed.**

Atkinson, Henry, Etchemin, Que. *Advt. page 222.*  
Bryan Mfg Co. (The), Collingwood, Ont.  
Brennen Sons Mfg Co. Ltd. (The M.), Hamilton, Ont.  
Beck, C. Mfg Co. Ltd., Penetanguishene, Ont.  
Brunette Saw Mill Co. Ltd., New Westminster, B. C.  
Cane & Sons Mfg Co. (The Wm.), Newmarket, Ont. *Advt. page 218.*

Chalifour, O., Quebec, Que.  
Capital Planing Mill Co. Ltd., Ottawa, Ont.  
Cookshire Mills Co., Cookshire, Que.  
Copping William, Joliette, Que.  
Eastman Lumber Co., Eastman, Que.  
Edwards, W. C. & Co., Ltd., Ottawa, Ont. *Advt. 219.*  
Gignac, O. & Fils, Quebec, Que.  
Gilmore & Co., Trenton, Ont.  
Gravel Lumber Co. Ltd. (The A.), Etchemin, Que. *Advt. page 215.*  
Henderson Bros., Montreal, Que.

Murphy, J. E., Hepworth Station, Ont.  
Nesbitt, E. T., Quebec, Que.

Piggott, John & Sons, Chatham, Ont.  
Pembroke Lumber Co., Pembroke, Ont. *Advt. 216.*  
Rathbun Co. (The), Deseronto, Ont. *Advt. page 162.*  
Rhodes, Curry & Co., Ltd., Amherst, N. S. *Advt. 158.*  
Shuswap Milling Co., Kamloops, B. C.  
Thompson, W. R., Teeswater, Ont. *Advt. p. 233.*  
Vance James, Hepworth Station, Ont. *Advt. p. 256.*  
Cassady, Geo. & Co., Vancouver, B. C.

**2042—LUMBER—Ash, Basswood, Elm, Hemlock.**

Cane & Sons Mfg Co. Ltd. (The Wm.), Newmarket, Ont. *Advt. page 218.*  
Chatham Mfg Co. Ltd., Chatham, Ont. *Advt. 245.*  
Dickson Co. (The), Peterboro, Ont. *Advt. page 250.*  
DeCew, T. H., Essex, Ont. *Advt. page 214.*

Deutschman, Fred, Teeswater, Ont. *Advt. page 218.*  
 Edwards, W. C. & Co. Ltd., Ottawa, Ont. *Advt. 219.*  
 Gravel, Lumber Co. Ltd., Etchemin, Que. *Advt. 215.*  
 Pembroke Lumber Co., Pembroke, Ont. *Advt. 216.*  
 Playfair, James & Co., Midland, Ont. *Advt. p. 223.*  
 Price, H. M. & Co., Quebec, Que. *Advt. page 223.*  
 Rathbun Co. (The), Deseronto, Ont. *Advt. page 162.*  
 Rhodes, Curry & Co. Ltd., Amherst, N. S. *Advt. 158.*  
 Thompson, W. R., Teeswater, Ont. *Advt. page 233.*  
 Vance, James, Hepworth Station, Ont. *Advt. p. 256.*  
 Wenger, N. & Bros., Ayton, Ont.  
 Parker & Howe, Dixville, Que.  
 Pardo, T. L., Cedar Springs, Ont.  
 Murphy, J. E., Hepworth Station, Ont.  
 Klock, R. H. & Co., Klocks Mills, Ont.  
 Gignac, O. & Sons, Quebec, Que.  
 Eastman Lumber Co., Eastman, Que.  
 Coleman, T. T. (Estate of), Seaforth, Ont.  
 Cargill, H. & Son, Cargill, Ont.  
 Zimmerman, S. C., Harrow, Ont.  
 Young, Wm., Wiarton, Ont.  
 White, A. & P., Pembroke, Ont.  
 Wooldridge, M., Palmerston, Ont.  
 Wilson, S. B. & Son, Louise, Ont.  
 Ward & Irwin, Rocklyn, Ont.  
 Witthun, C. H. & Co., Hepworth, Ont.  
 Willard, J. C. & Sons, Bolton Centre, Que.  
 Thompson & Avery, Sharbot Lake, Ont.  
 Tonor & Gregory, Collingwood, Ont.  
 Tourville Lumber Mills Co. (The), Montreal, Que.  
 Tait, A., Orillia, Ont.  
 Truax, R. & Co., Walkerton, Ont.  
 Summer Co., Moncton, N. B.  
 Seaman & Newman, Wiarton, Ont.  
 Stark, R. A., Owen Sound, Ont.  
 Starks, James, Paisley, Ont.  
 Stinson, J. & Son, Broton, Ont.  
 Sticklesteel, D. P., McGregor, Ont.  
 Smith, J. B. & Sons, Collander, Ont.  
 Shaw, John, Bridgen, Ont.  
 Ross, L. A., Cornwall, Ont.  
 Reese, H. C., South Woodslie, Ont.  
 Pedwell, Henry, Thornbury, Ont.  
 Picard & Rowan, Owen Sound, Ont.  
 Olmstead, R., Water's Falls, Ont.  
 Ottawa Lumber Co. (The), Calumet, Que.  
 Neilson, R. & A., Proton Station, Ont.  
 Naylor, Charles E., Essex, Ont.  
 McNeil Walter, Leith, Ont.  
 Mitchell Bros., Berkeley, Ont.  
 McLean & Son, Wingham, Ont.  
 McEwen & Munro, Moose Creek, Ont.  
 Macpherson & Schell, Alexandria, Ont.  
 McGarvin, D. R., Chatham, Ont.  
 Meredith, J. K., South Indian, Ont.  
 Marsh, Henry, Richmond Hill, Ont.  
 McLachlin Bros., Arnprior, Ont.  
 Mason, Wm. & Sons, Ottawa, Ont.  
 Murray, John, Ruscomb Station, Ont.  
 McPhee, A. D. & Co., Alexandria, Ont.  
 Morran, Richard, Allenford, Ont.  
 McRae, Bros. & Co., Ottawa, Ont.  
 McDermott, J., Victoria Harbor, Ont.  
 McPherson, A. & Co., Lonford Mills, Ont.  
 McGibbon, F. & Sons, Penetanguishene, Ont.  
 McNeil, Walter, Leith, Ont.  
 Maitland & Riscon, Owen Sound, Ont.  
 Lawson, W. H., Park Head, Ont.  
 Little, Charles, Maidstone, Ont.  
 Kidd, John, Wiarton, Ont.  
 Kastner, Gedeon, Wiarton, Ont.  
 King, G. G. & W. C., Chipman, N.B.

Jones Bros., Wiarton, Ont.  
 Howes & Joshua, Harriston, Ont.  
 Howes & Leighton, Harriston, Ont.  
 Haynes & Foder, South Woodslie, Ont.  
 Hahn, Lewis, New Hamburg, Ont.  
 Hurlbert, H. J., Mitchell, Ont.  
 Goodhue Bros., Danville, Ont.  
 Goodbout, Joseph, St. George de Windsor, Que.  
 Georgian Bay Lumber Co. Ltd., Waubausherne, Ont.  
 Gilmour & Hughson, Hull, Que.  
 Gilmour & Co., Trenton, Ont.  
 Fiske, Edward, Joliette, Ont.  
 Eish, R. Y., Waterloo, Ont.  
 Findley, J. S., Owen Sound, Ont.  
 Fisher, A., Paisley, Ont.  
 Fox, Albert L. Karrow, Ont.  
 Elmwood Lumber Co., Elmwood, Ont.  
 Davidson, D., Penetanguishene, Ont.  
 Doty, John, Bridgen, Ont.  
 Dey, Thos., Moose Creek, Ont.  
 Drader, Wm. M., Northwood, Ont.  
 Carew, John, Lindsay, Ont.  
 Campion, Geo., Owen Sound, Ont.  
 Cook, James, Rocklyn, Ont.  
 Cooper, D. G., Collingwood, Ont.  
 Church, Mitchell & Fee, Mitchell Station, Que.  
 Conklin, David, Kingsville, Ont.  
 Coupal, Joseph, Casselman, Ont.  
 Craig, James, Cottam, Ont.  
 Craig, J. P., Proton, Ont.  
 Brennen Sons Mfg Co. Ltd. (The), Hamilton, Ont.  
 Beck, C. Mfg Co. Ltd., Penetanguishene, Ont.  
 Breakey, John, Chaudiere Mills, Que.  
 Betts, Chas., Ruscomb Station, Ont.  
 Bunstead, Chas. E., Brookholm, Ont.  
 Biette & Co., Chesley, Ont.  
 Asmus, Lewis, Allenford, Ont.  
 Allen, I., Mississippi Station, Ont.  
 Sadler, Dundas & Flavelle Milling Co., Lindsay, Ont.

#### 2043—LUMBER—Beech, Birch, Cedar, Maple,

Biette & Co. Chesley, Ont. *Advt. page 240.*  
 Button & Fessant, Wingham, Ont. *Advt. page 251.*  
 Cane & Sons Mfg Co. Ltd. (The Wm.), Newmarket, Ont. *Advt. page 218.*  
 Chatham Mfg Co., Ltd., Chatham, Ont. *Advt. p. 245.*  
 DeCew, T. H., Essex, Ont. *Advt. page 214.*  
 Deutschmann, Fred, Teeswater, Ont. *Advt. p. 218.*  
 Dickson, Co. (The), Peterboro, Ont. *Advt. page 250.*  
 Edwards, W. C. & Co. Ltd., Ottawa, Ont. *Advt. p. 219.*  
 Gale, Geo. & Sons, Waterville, Que. *Advt. page 258.*  
 Gravel, A. Lumber Co., Etchemin, Que. *Advt. 215.*  
 Pembroke Lumber Co., Pembroke, Ont. *Advt. 216.*  
 Thompson, W. R., Teeswater, Ont. *Advt. page 233.*  
 Rathbun Co. (The), Deseronto, Ont. *Advt. page 162.*  
 Rhodes, Curry & Co. Ltd., Amherst, N. S. *Advt. 158.*  
 Pardo, T. L., Cedar Springs, Ont.  
 Parker & Howe, Dixville, Que.  
 Murphy, J. E., Hepworth Station, Ont.  
 Klock, R. H. & Co., Klocks Mills, Ont.  
 Eastman Lumber Co., Eastman, Que.  
 Coleman, T. T. (Estate of), Seaforth, Ont.  
 Cookshire Mills Co., Cookshire, Que.  
 Copping, Wm., Joliette, Que.  
 Allen, I. Mississippi Station, Ont.  
 Asmus, Lewis, Allenford, Ont.  
 Bunstead, Chas. E., Brookholm, Ont.  
 Beck C. Mfg Co. Ltd., Penetanguishene, Ont.  
 Betts, Chas., Ruscomb Station, Ont.  
 Brennen Sons Mfg Co. Ltd. (The M.) Hamilton, Ont.  
 Brunette Saw Mill Co. Ltd., New Westminster, B. C.  
 Cassady, Geo. & Co. Ltd., Vancouver, B. C.

Cook, James, Rocklyn, Ont.  
 Craig, J. P., Proton, Ont.  
 Church, Mitchell & Fee, Mitchell Station, Que.  
 Coupal, Joseph, Casselman, Ont.  
 Conklin, David, Kingsville, Ont.  
 Craig, James, Cottam, Ont.  
 Carew, John, Lindsay, Ont.  
 Cargill, H. & Son, Cargill, Ont.  
 Champion, Geo., Owen Sound, Ont.  
 Doty, John, Bridgen, Ont.  
 Drader, Wm. M., Northwood, Ont.  
 Dey, Thosmas, Moose Creek, Ont.  
 Elmwood Lumber Co., Elmwood, Ont.  
 Fiske, Edward, Joliette, Que.  
 Fish, R. Y., Waterloo, Ont.  
 Fisher, A., Paisley, Ont.  
 Fox, Albert L., Harrow, Ont.  
 Findley, J. S., Owen Sound, Ont.  
 Goodhue Bros., Danville, Que.  
 Greenshields, John, Danville, Que.  
 Howes, Joshua, Harriston, Ont.  
 Howes & Leighton, Harriston, Ont.  
 Haynes, C. S., South Woodslee, Ont.  
 Hahn, Lewis, New Hamburg, Ont.  
 Hurlbert, H. J., Mitchell, Ont.  
 Jones Bros., Wiarton, Ont.  
 Kastner, Gideon, Wiarton, Ont.  
 King, G. G. & W. C., Chipman, N. B.  
 Kaufman, Jacob, Berlin, Ont.  
 Kidd, John, Wiartou, Ont.  
 Little, Charles, Maidstone, Ont.  
 Lyons, A., Blackwater Junction, Ont.  
 Lawson, W. H., Park Head, Ont.  
 Meredith, J. K., South Indian, Ont.  
 Macpherson & Schell, Alexandria, Ont.  
 McGarvin, D. R., Chatham, Ont.  
 McLean & Son, Wingham, Ont.  
 McPhee, A. D. & Co., Alexandria, Ont.  
 Mitchell Bros., Berkeley, Ont.  
 Maitland & Riscon, Owen Sound, Ont.  
 Morran, Richard, Allenford, Ont.  
 McNeil, Walter, Leith, Ont.  
 McEwen & Munro, Moose Creek, Ont.  
 McGarvin, D. R., Chatham, Ont.  
 Murray, John, Ruscomb Station, Ont.  
 Mason, Wm. & Sons, Ottawa, Ont.  
 McDermott, J., Victoria Harbor, Ont.  
 Nelson, J., Bear Lake, Ont.  
 Neilson, R. & A., Proton Station, Ont.  
 Naylor, Charles E., Essex, Ont.  
 Olmstead, R., Water's Falls, Ont.  
 Pedwell, Henry, Thornbury, Ont.  
 Picard & Rowan, Owen Sound, Ont.  
 Red Cedar Lumber Co., Victoria, B. C.  
 Reese, H. C., South Woodslie, Ont.  
 Sadler, Dundas & Flavelle Milling Co. Ltd., Lindsay, Ont.  
 Stinson, J. & Son, Proton, Ont.  
 Seaman & Newman, Wiarton, Ont.  
 Starke, James, Paisley, Ont.  
 Stark, R. A., Owen Sound, Ont.  
 Sticklesteel, D. P., McGregor, Ont.  
 Shaw, John, Bridgen, Ont.  
 Truax, R. & Co., Walkerton, Ont.  
 Toner & Gregory, Collingwood, Ont.  
 Thompson & Avery, Sharbot Lake, Ont.  
 Tait, W. L., Vancouver, B. C.  
 Vance, James, Hepworth Station, Ont. *Advt. p. 256.*  
 Wooldridge, M., Palmerston, Ont.  
 Witthun, C. H. & Co., Hepworth, Ont.  
 Wilson, S. B. & Son, Louise, Ont.  
 Ward & Irwin, Rocklyn, Ont.

Wenger, N. & Bros., Ayton, Ont.  
 Young, Wm., Wiarton, Ont.,  
 Zimmerman, S. C., Harrow, Ont.

#### 2044—LUMBER—Oak.

Chatham Mfg Co. Ltd., Chatham, Ont. *Advt. p. 245.*  
 DeCew, T. H., Essex, Ont. *Advt. page 214.*  
 Cane & Sons Mfg Co. Ltd. (The Wm.) Newmarket, Ont. *Advt. page 218.*  
 Dickson Co. (The), Peterborough, Ont. *Advt. 250.*  
 Edwards, W. C. & Co. Ltd., Ottawa, Ont. *Advt. 219.*  
 Rathbun Co. (The), Deseronto, Ont. *Advt. p. 162.*  
 Georgean Bay Lumber Co. Ltd. Waubaushene, Ont.  
 McLean & Son, Wingham, Ont.  
 Doty, John, Bridgen, Ont.  
 McGarvin, D. R., Chatham, Ont.  
 Murray, John, Ruscomb Station, Ont.  
 Naylor, Charles E., Essex, Ont.  
 Little, Charles, Maidstone, Ont.  
 Conklin, David, Kingsville, Ont.  
 Zimmerman, S. C., Harrow, Ont.  
 Fox, Albert L., Harrow, Ont.  
 Cargill, H. & Son., Carnill, Ont.  
 Shaw, John, Bridgen, Ogt.  
 Allen, I., Mississippi Station, Ont.  
 Craig, James, Cottam, Ont.  
 Betts, Chas., Ruscomb Station, Ont.  
 Haynes, C. S., South Woodslie, Ont.  
 Sticklesteel, D. P., McGregor, Ont.  
 Reese, H. C., South Woodslie, Ont.  
 Beck, C. Mfg Co. Ltd., Penetanguishene, Ont.  
 McDermott, J., Victoria Harbor, Ont.

#### 2045—LUMBER—Balm of Gilead.

Chatham Mfg Co. Ltd., Chatham, Ont. *Advt. p. 245.*

#### 2046—LUMBER—Antiseptic, Sanitas Wood.

American Hardwood Co. Ltd., Ottawa, Ont.

#### 2047—LUMBER—Douglas Fir.

McLean & Son, Wingham, Ont.  
 Brunette Saw Mill Co. Ltd., New Westminster, B. C.  
 Tait, W. C., Vancouver, B. C.  
 Cassady, Geo. & Co. Ltd., Vancouver, B. C.

#### 2048—LUMBER — Buttonwood, Butternut, Cottonwood, Hickory, Sycamore, Tamarack, Walnut, Whitewood, Poplar.

Chatham Mfg Co. Ltd., Chatham, Ont. *Advt. p. 245.*  
 Dickson Co. (The), Peterboro, Ont. *Advt. page 250.*  
 DeCew, T. H., Essex, Ont. *Advt. page 214.*  
 Edwards, W. C. & Co. Ltd., Ottawa, Ont. *Advt. 219.*  
 Rathbun Co. (The), Deseronto, Ont. *Advt. page 162.*  
 Pardo, T. L., Cedar Springs, Ont.  
 McGarvin, D. R., Chatham, Ont.  
 McLean & Son, Wingham, Ont.

#### 2049—LUMBER—Pine, Pine Lath.

Atkinson, Henry, Etchemin, Que. *Advt. page 222.*  
 Beck, C. Mfg Co. Ltd., Penetanguishene, Ont.  
 Blind River Lumber Co. (The), Blind River, Ont.  
 Breakey, John, Chaudiere Mills, Que.  
 Booth, J. R., Ottawa, Ont.  
 Buell, Hurdman & Co., Hull, Que.  
 Baptist, Alex., Three Rivers, Que.  
 Bronson & Weston Lumber Co. Ltd., Ottawa, Ont.  
 Brennen Sons Mfg Co. (The M.), Hamilton, Ont.  
 Barnhill, Geo. E., Fairville, N. B.  
 Bedard, Joseph, Richmond, Que.  
 Bigelow, A. & Son, Lower Stewiacke, N. S.  
 Copping William, Joliette, Que.

Conlon, J. & T., Thorold, Ont.  
 Canada Lumber Co. Ltd. (The), Carleton Place, Ont.  
 Cookshire Mills Co., Cookshire, Que.  
 Cane & Sons Mfg Co. Ltd. (The Wm.), Newmarket, Ont. *Adv. page 218.*  
 Cutler & Savidge Lumber Co., Webbwood, Ont.  
 Cushing, André & Co., St. John, N.B.  
 Cargill, H. & Son, Cargill, Ont.  
 Carswell & McKay, Calabogie, Ont.  
 Church, Mitchell & Fee, Mitchell Station, Que.  
 Cook & Bros. Lumber Co., Toronto, Ont.  
 Cutler & Savidge Lumber Co., Kenabutch, Ont.  
 Cooper, D. G., Collingwood, Ont.  
 Davidson, D., Penetanguishene, Ont.  
 Dickie, Alfred, Lower Stewiacke, N.S.  
 Davidson, Hay & Co., Toronto, Ont.  
 Dickson Co. (The), Peterborough, Ont. *Adv. p. 250.*  
 Drummondville Lumber Co., Forestdale, Que.  
 Dunn, E. G. & Co., St. John, N.B.  
 Edwards, W. C. & Co. Ltd., Ottawa, Ont. *Adv. 219.*  
 Fiske, Edwards, Joliette, Que.  
 Georgian Bay Lumber Co. Ltd., Waubaushene, Ont.  
 Gibson, Alex. & Sons Ltd., Marysville, N. B.  
 Gilmour & Hughson, Hull, Que.  
 Gillies Bros. Co. Ltd. (The), Breaside, Ont.  
 Gilmour & Co., Trenton, Ont.  
 Gravel, A. Lumber Co. Etchemin, Que. *Adv. p. 215.*  
 Hawkesbury Lumber Co. Ltd., Hawkesbury, Ont.  
 Hollister, Jewell & Co., Garden River, Ont.  
 Henderson, Bros., Montreal, Que.  
 Imperial Lumber Co. Ltd., Toronto, Ont.  
 Jewett, E. D. & Co., St. John, N. B.  
 King Bros., Quebec, Que. *Adv. page 240.*  
 Kelly Bros., River Herbert, N. S.  
 King, G. G. & W. C., Chipman, N. B.  
 Klock, R. H. & Co., Aylmer, Que.  
 King, S. T. & Son, Millford, N. B.  
 Keewatin Lumber & Mfg Co., Keewatin, Ont.  
 Longford Lumber Co., Longford Mills, Ont.  
 Laidlaw, Robert & Co., Toronto, Ont.  
 Leonard & Morin, Garthly, Que.  
 McPherson, A. & Co., Longford Mills, Ont.  
 MacLaren, James (Estate of), Buckingham, Que.

Mickle, Dymont & Son, Barrie, Ont.  
 McDermott, J., Victoria Harbor, Ont.  
 Mason, Wm. & Sons, Ottawa, Ont.  
 McRae, Bros. & Co., Ottawa, Ont.  
 Miller & Woodman, St. John, N.B.  
 McGibbon, F. & Sons, Penetanguishene, Ont.  
 Murry, W. H., St. John, N.B.  
 Moore, Fred. & Sons, Woodstock, N.B.  
 McMullin, T. G., Truro, N.S.  
 Merrill, Ring & Co., Byng Inlet North, Ont.  
 McCool, C. A. & Co., Cartier, Ont.  
 Maitland, Rixon & Co., Owen Sound, Ont.  
 McLachlin Bros., Arnprior, Ont.  
 Mossom, Boyd & Co., Bobcaygeon, Ont.  
 Ottawa Lumber Co. (The), Calumet, Que.  
 Pembroke Lumber Co., Pembroke, Ont. *Adv. p. 216.*  
 Price, H. M. & Co., Quebec, Que. *Adv. page 223.*  
 Palyfair, James & Co., Midland, Ont. *Adv. p. 223.*  
 Prescott, Gillespie & Co., Shulee, N.S.  
 Pickard & Rowan, Owen Sound, Ont.  
 Parker & Howe, Dixville, Que.  
 Ross Bros., Buckingham, Que.  
 Rathbun Co. (The), Deseronto, Ont.  
 Rhodes, Curry & Co. Ltd., Amherst, N.S.  
 Ritchie, D. & J. & Co., Newcastle, N.B.  
 Randolph & Baker, St. John, N.B.  
 Sadler, Dundas & Flavelle Milling Co., Lindsay, Ont.

St. Maurice Lumber Co. Three Rivers, Que.  
 St. Anthony Lumber Co. Ltd. (The), Ottawa, Ont.  
 Spanish River Lumber Co., Spanish River, Ont.  
 Schell, Macpherson & Co., Sayabec, Que.  
 Toner & Gregory, Collingwood, Ont.  
 Tourville Lumber Mills Co. (The), Montreal, Que.  
 Stetson, Cutler & Co., St. John, N.B.  
 Sawyer, A. H., Benton, N.B.  
 Sargent Bros., Nelson, N.B.  
 Shives, Kelgour, Campbellton, N.B.  
 Tait, A., Orillia, Ont.  
 Victoria Harbor Lumber Co., Victoria Harbor, Ont.  
 Whaley Lumber Co. Ltd. (The), Huntsville, Ont.  
 White, A. & P., Pembroke, Ont.  
 White, C. T., Apple River, N.S.  
 White, E. J. & Son, Sand River, N.S.  
 Warner, R. J. & Co., St. John, N.B.  
 Vermillion Lumber Co., Three Rivers, Que.  
 Curtis, Warren, Three Rivers, Que.  
 Ontario & Western Lumber Co., Keewatin, Ont.  
 Huntsville Lumber Co., Huntsville, Ont.  
 Parry Sound Lumber Co., Parry Sound, Ont.  
 Holland & Emery Lumber Co., Wahnapiatae, Ont.  
 Muskoka Mill & Lumber Co., Muskoka Mills, Ont.  
 Saginaw Lumber Co., Nairn Station, Ont.

## 2050—LUMBER—Spruce.

Atkinson, Henry, Etchemin, Que. *Adv. page 222.*  
 Gale, Geo. & Sons, Waterville, Que. *Adv. p. 258.*  
 Gravel, A. Lumber Co., Etchemin, Que. *Adv. 215.*  
 King Bros., Quebec, Que. *Adv. page 240.*  
 Price, H. M. & Co., Quebec, Que. *Adv. page 223.*  
 Rathbun Co. (The), Deseronto, Ont. *Adv. page 162.*  
 Copping, William, Joliette, Que.  
 Cookshire Mills Co., Cookshire, Que.  
 Parker & Howe, Dixville, Que.  
 Breakey, John, Chaudiere Mills, Que.  
 Eastman Lumber Co., Eastman, Que.  
 Curtis, Warren, Three Rivers, Que.  
 Vassal, H., Drummondville, Que.  
 Comtois & Co., Drummondville, Que.  
 Drummondville Lumber Co. Forestdale, Que.  
 Ray & Robinson, St. Cyrille, Que.  
 Willard, J. C. & Sons, Bolton Centre, Que.  
 Tait, A., Orillia, Ont.  
 Lewell, E. L., Lake St. Joseph, Que. (Lake St. John, R. R.)  
 White, A. & P., Pembroke, Ont.  
 Ross, Frank, River A. Pierre, Que.  
 Baker, P. W., Lake Edward, Que. (Lake St. John, R. R.)  
 Rousseau, P. A., Notre Dame des Anges, Que.  
 Palbert, D., Lake Bouchette, (Lake St. John, R.R.).  
 Scott, B. A., Roberval, Que.  
 Martineau, E., St. Gabriel Station, Que. (Lake St. John, R. R.)  
 Clark Bros., Bear Rivers, N. S.  
 Red Cedar Lumber Co., Victoria, B. C.  
 Cutler & Savidge Lumber Co., Kenabutch, Ont.  
 Cushing, Andre & Co., St. John, N. B.  
 Culter & Savidge Lumber Co., Webbwood, Ont.  
 Champoux, John, D'Israeli, Que.  
 Cassady, Geo. & Co., Ltd., Vancouver, B. C.  
 Cass Bros., Martinville, Que.  
 Dunn, E. G. & Co., St. John, N. B.  
 Dickie, Alfred, Lower Stewiacke, N. S.  
 Palmer, J. S., Sherbrooke, Que. *Adv. page 228.*  
 Kelly Bros., River Herbert, N. S.  
 Shives, Kelgour, Campbellton, N. B.  
 Tourville Lumber Mills Co. (The), Montreal, Que.  
 Taylor, John, Magog, Que.  
 Vermillion Lumber Co., Three Rivers, Que.

King, G. G. & W. C., Chipman, N. B.  
 Gagnon, J. G., Three Rivers, Que.  
 Tangua, Chas., Weeden, Que.  
 Tangua, N. P., Weeden, Que.  
 Jewett, E. D. & Co., St. John, N. B.  
 King, S. T. & Son, Millford, N. B.  
 Kent, Wm. J., Truro, N. S.  
 Leonard, M., Wickham West, Que.  
 Hanning, H. R., Nicolet Falls, Que.  
 Hutchinson, E., Douglstown, N. B.  
 Miller & Woodman, St. John, N. B.  
 Brunette Saw Mill Co. Ltd., New Westminster, B. C.  
 Bigelow, A. & Son, Lower Stewiacke, N. S.  
 Bedard, Joseph, Richmond, Que.  
 Barnhill, Geo. E., Fairville, N. B.  
 Adams, Charles, Marbleton, Que.  
 Stetson, Cutler & Co., St. John, N. B.  
 Warner, James R. & Co., St. John, N. B.  
 Parker & Bishop, Marbleton, Que.  
 St. Maurice Lumber Co., Three Rivers, Que.  
 Joliette Lumber Co., Joliette, Que.  
 Ottawa Lumber Co. (The), Calumet, Que.  
 McMullen, T. G., Truro, N. S.  
 Randolph & Baker, St. John, N. B.  
 McRae, Bros. & Co., Ottawa, Ont.  
 Mason, Wm. & Sons, Ottawa, Ont.  
 Mossom, Boyd & Co., Bobcaygeon, Ont.  
 Fiske, Edward, Joliette, Que.  
 Goodhue Bros., Danville, Que.  
 Gilmour & Hughson, Hull, Que.  
 Beausolois, Avangelist, St. Gabriel de Brandon, Que.  
 Basinet, Charles, St. Jean de Matha, Que.  
 Rousseau, J. A., St. Anne de la Pérade, Que.  
 Shulie Lumber Co., Shulie, N. S.  
 Hill, French & Co., Musquodoboit Harbor, N. S.  
 Henderson Bros., Montreal, Que.  
 Murray, W. H., St. John, N. B.  
 MacLaren, James (Estate of), Buckingham, Que.  
 Prescott, Gillespie & Co., Shulie, N. S.  
 Church, Mitchell & Fee, Mitchell Station, Que.  
 Greenshields, John, Danville, Que.

**2051—MACARONI.** See No. 3660.

**2052—MACHINE—(Wood Boring), Horizontal, Vertical.**

Ballantine, John & Co., Preston, Ont. *Advt. p. 205.*  
 Goldie & McCulloch Co. Ltd., Galt, Ont. *Advt. 159.*  
 MacGregor, Gourlay & Co., Galt, Ont.

**2053—MACHINES—“Combined” Punching, Shearing, Rolling & Upsetting.**

Sleeper & Akhurst, Coaticook, Que. *Advt. page 241.*

**2054—MACHINES—Rail Punching.**

Bertram, John & Sons, Dundas, Ont. *Advt. page 161.*  
 Goldie & McCulloch Co. Ltd., Galt, Ont. *Advt. 159.*

**2055—MACHINES—Moss & Hair.** See No. 2086.

**2056—MACHINES—Picket (Wood).**

Canadian Lock & Engine Co., Kingston, Ont.  
*Advt. page 175.*

**2057—MACHINE—Pegging, Power Punch, Eyelet, Heeling.** See No. 2119.

**2058—MACHINES—(Portable) Stone Planing.**

Bertram, John & Sons, Dundas, Ont. *Advt. page 161.*

**2059—MACHINES—Tailors' Pressing.**

Smart, (Jas.) Mfg Co., Brockville, Ont. *Advt. p. 178.*

**2060—MACHINES—(Threshing), Overshot, Undershot.**

Moody, Matthew & Sons, Terrebonne, Que.  
*Advt. page 209.*

**2061—MACHINES—Nut Tapping.**

Maguire & Dryden, Toronto, Ont.

**2062—MACHINES—Broom Handle, Tanners' Scouring.**

Bateman, Wm., Montreal, Que. *Advt. page 247.*

**2063—MACHINES—Typograph.**

Dominion Typograph Co. Ltd., Windsor, Ont.

**2064—MACHINES—Cork Driving, Bottle Capping.**

Doyle, J. E. & Co., Montreal, Que. *Advt. page 235.*

**2065—MACHINES—Cloth Soaping, Yarn Doubling.**

Karch, H. W., Hespeler, Ont.

**2066—MACHINES—Ditching.**

Carrier, Laine & Co., Levis, Que. *Advt. page 150.*

**2067—MACHINES—Barrel Trusser.**

Steinhoff & Gordon, Wallaceburg, Ont. *Advt. p. 192.*

**2068—MACHINES—Stamp Cancelling.**

Morton, Phillips & Co., Montreal, Que.

**2069—MACHINES—Boring.**

Smart (James) Mfg Co., Brockville, Ont. *Advt. 178.*

**2070—MACHINES—Button Making ‘Schotts’.**

St. Lawrence Steel & Wire Co., Gananoque, Ont.  
*Advt. page 183.*

**2071—MACHINES—Saw Filing & Cumming.**

Canadian Locomotive & Engine Co., Kingston, Ont.  
*Advt. page 175.*

Ballantine, John & Co., Preston, Ont. *Advt. p. 205.*  
 Waring, White & Co., St. John, N. B. *Advt. p. 256.*

**2072 & 2073—MACHINES—(Wood working) Mortising, Hub Mortising, Timber Ganging, Blind Wiring, Dove Tailing, Milling, Post Boring, Sash Door & Blind Turning.**

Ballantine, John & Co., Preston, Ont. *Advt. p. 205.*  
 Cane Bros. Co. Ltd., Galt, Ont. *Advt. page 259.*  
 Goldie & McCulloch Co. Ltd., Galt, Ont. *Advt. 159.*  
 MacGregor, Gourlay & Co., Galt, Ont.

**2074—MACHINES—Portable Sawing.**

See No. 2075.

**2075—MACHINES—Shingle Sawing, Cross Cut Saw.**

Goldie & McCulloch Co. Ltd., Galt, Ont. *Advt. 159.*  
 Vidal, Fils & Cie, Quebec, Que. *Advt. page 205.*  
 Paxton, Tate & Co., Port Perry, Ont.  
 Hamilton (Wm.) Mfg Co. Ltd., Peterborough, Ont.  
 Carrier, Laine & Co., Levis, Que. *Advt. page 150.*  
 Cantin, E., Warwick, Que.  
 Chalifoux, O. & Sons, St. Hyacinthe, Que. *Advt. 232.*  
 Canadian Locomotive & Engine Works Co. Ltd.  
 Kingston, Ont. *Advt. page 175.*  
 Young Bros., Almonte, Ont. *Advt. page 250.*

McKinnon & McLean, Charlottetown, P.E.I.  
Lloyd Mfg Co., Kentville, N.S.  
Waterous Engine Works Co. Ltd. Brantford, Ont.  
Sleeper & Akhurst, Coaticook, Que. *Advt. page 241.*  
Moody, Matthew & Sons, Terrebonne, Que. *Advt. 209.*  
Truro Foundry & Machine Co., Truro, N.S. *Advt. 198.*  
Small & Fisher, Woodstock, N.B.  
Robb Engineering Co., Amherst, N.S.

*See inside front cover.*

**2076—MACHINES—Clothes Washing.**

Mac Machine Co., Belleville, Ont. *Advt. page 194.*  
Dowswell Bros. & Co., Hamilton, Ont. *Advt. p. 243.*  
Connor, J. H., Ottawa, Ont.  
Storey Washing Machine Co., Ottawa, Ont.  
Moffatt & Co., Carleton Place, Ont.  
Schultz Bros., Brantford, Ont.

**2077—MACHINES—Threshing, (Grain).**

Moody, Matthew & Sons, Terrebonne, Que. *Advt. page 209.*

Joliette Foundry Co., Joliette, Que.  
Macpherson & Hovey Co., Clinton, Ont.  
Waterloo Mfg Co. Ltd., Waterloo, Ont. *Advt. p. 218.*  
Sawyer & Massey Co. Ltd., Hamilton, Ont.  
Small & Fisher, Woodstock, N. B.  
Chalifoux, O. & Sons, St. Hyacinthe, Que. *Advt. 232.*  
Bessette, J. & S., Iberville, Que.  
Cantin, E., Warwick, Que.  
Macpherson & Co., Fingal, Ont.

**2078—MACHINES—(Hoisting & Handling),  
Coal, Ore, Stone, (Double & Single Drum),  
Speed, Friction, Horse Power, Steam.**

Matheson, I. & Co., New Glasgow, N. S. *Advt. 200.*  
Beatty, M. & Sons, Welland, Ont. *Advt. page 173.*  
Carrier, Laine & Co., Levis, Que. *Advt. page 150.*  
Jenckes Machine Co., Sherbrooke, Que. *Advt. 165.*  
Mac Machine Co., Belleville, Ont. *Advt. page 194.*  
Ingersoll Rock Drill Co., Montreal, Que. *Advt. 198.*  
Fleck, Alex. Jr., Ottawa, Ont. *Advt. page 252.*

**2079—MACHINES—Rivet, Tubular Rivet.**

Parmenter & Bullock, Gananoque, Ont. *Advt. p. 199.*

**2080—MACHINES—Linotype, Manoline, Type  
Line Casting.**

Linotype Co., Montreal, Que. *Advt. page 254.*

**2081—MACHINES—Knitting.**

Creelman Bros., Georgetown, Ont.

**2082—MACHINES—(Ironing), Collar & Cuff.**

Myers, W. F. & J. W., St. John, N. B. *Advt. p. 163.*  
Mac Machine Co., Belleville, Ont. *Advt. page 194.*

**2083—MACHINES—Barrel Heading, Pulp  
Grinding, Stave Crozing.**

Lloyd Mfg Co., Kentville, N. S.

**2084—MACHINES—Bottling, Corking.**

Mitchell, Robert & Co., Montreal, Que. *Advt. 213.*  
Canada Cork Cutting Co., Montreal, Que. *Advt. 223.*

**2085—MACHINES—Composing, Typesetting.**

Scudder, W. S., Montreal, Que.

**2086—MACHINES—Cheese Box Nailing &  
Bending, Cheese Box Heading.**

Mac Machine, Co., Belleville, Ont. *Advt. p. 194.*

**2087—MACHINES—Pulp Wood, Rossing.**

Jenckes Machine Co., Sherbrooke, Que. *Advt. 165.*

**2088—MACHINE—Wood Splitting.**

Bateman, Wm. & Co., Montreal, Que. *Advt. p. 247.*

**2089—MACHINES—Wire Fence, (Hand).**

Locked Wire Fence Co. Ltd. (The), Ingersoll, Ont.

**2090—MACHINES—(Hoisting & Handling),  
Earth.**

Beatty, M. & Sons, Welland, Ont. *Advt. page 173.*  
Mac Machine Co., Belleville, Ont. *Advt. page 194.*

**2091—MACHINES—Screw Polishing.**

Stevens, Hamilton & Co., Galt, Ont.

**2092—MACHINES—(Polishing), Emery Belt,  
Horizontal, Upright. See No. 3749.**

**2093—MACHINES—(Band Saw), Double.**

Ballantine, John & Co., Preston, Ont. *Advt. p. 205.*  
Bertram, John & Sons, Dundas, Ont. *Advt. page 161.*  
Goldie & McCulloch Co., Ltd., Galt, Ont. *Advt. 159.*  
Robb Engineering Co. Ltd., Amherst, N.S.

*See inside front cover.*

Waterous Engine Works Co. Ltd., Brantford, Ont.

**2094—MACHINES—(Sewing), Lock Stitch.**

Raymond, Charles, Guelph, Ont.  
Singer Mfg Co., Montreal, Que.  
Williams Mfg Co., Montreal, Que.

**2095—MACHINES—Sand Papering, Scroll  
Sawing.**

Ballantine, John & Co., Preston, Ont. *Advt. p. 205.*  
Robb Engineering Co. Ltd., Amherst, N.S.

*See inside front cover.*

MacGregor, Gourlay & Co., Galt, Ont.

**2096—MACHINES—(Shaping), Iron Top, Saw  
Scarving.**

Ballantine, John & Co., Preston, Ont. *Advt. p. 205.*

**2097—MACHINES—Journal Box Shaping,  
Key Seating, Shaft Straightening, Slot-  
ting.**

Bertram, John & Sons, Dundas, Ont. *Advt. p. 161.*

**2098—MACHINES—Bench Boring.**

Bertram, John & Sons, Dundas, Ont. *Advt. p. 161.*  
Jackson, Cochrane & Co., Berlin, Ont.  
Bateman, Wm. & Co., Montreal, Que. *Advt. p. 247.*  
Goldie & McCulloch Co. Ltd., Galt, Ont. *Advt. 159.*  
Stevens, Hamilton & Co., Galt, Ont.

**2099—MACHINES—Chancelling, (Slate &  
Marble).**

Canadian Rand Drill Co., Sherbrooke, Que. *Advt. page 165.*

**2100—MACHINES—Milk Testing, (Babcock).**

Macpherson, D. M., Lancaster, Ont.

**2101—MACHINES—Automatic, Centering,  
Cutting-Off, Cylinder, Emery Surface,  
Grinding, Mill Boring, Nut Facing, Roll  
Grooving, Steam Riveting, Tapping.**

Bertram, John & Sons, Dundas, Ont. *Advt. p. 161.*

**2102—MACHINES—See No. 2072.**



**2103—MACHINES—Napping.**Goldie & McCulloch Co. Ltd., Galt, Ont. *Advt.* 159.**2104—MACHINES—Card Grinding.**Bertrand, F. X., St. Hyacinthe, Que.  
Goldie & McCulloch Co. Ltd., Galt, Ont. *Advt.* 159.**2105—MACHINES—(Sawing), Folding.**

Folding Sawing Machine Co., Essex, Ont.

**2106—MACHINES—Emery Grinding.***See No.* 3749.**2107—MACHINES—Folding (Metal).***See No.* 2630.**2108—MACHINES—Dynamo Electric.**Canadian General Electric Co. Ltd., Toronto, Ont.  
Kay Electric Works, Hamilton, Ont. *Advt.* p. 233.**2109—MACHINES—Cheese Box.**Mac Machine Co., Belleville, Ont. *Advt.* page 194.  
Carrier, Laine & Co., Levis, Que. *Advt.* page 150.  
Lancaster Machine Works, Lancaster, Ont. *Advt.* 248.**2110—MACHINES—Butting, Clapboard.**Waring, White & Co., St. John, N. B. *Advt.* p. 256.  
Sleeper & Akhurst, Coaticook, Que. *Advt.* page 241.**2111—MACHINES—Wood Barking.**Jenckes Machine Co., Sherbrooke, Que. *Advt.* p. 165.  
Eastman Lummer Co., Eastman, Que.  
Three Rivers Iron Works, Three Rivers, Que.  
*Advt.* page 179.**2112—MACHINES—(Boring) Horizontal, Metal, Portable, Metal, Vertical, Chucking, Gear Cutting, (Drilling), Horizontal, Link, Combined Drill & Tapping, (Mill-  
ing), Butt, Hand, Nutt, Universal, Valve, Vertical.**Bertram, John & Sons, Dundas, Ont. *Advt.* p. 161.  
Stevens, Hamilton & Co., Galt, Ont.  
Gardner, Robert & Son, Montreal, Que.**2113—MACHINES—(Cloth), Brushing, Folding, Measuring, Rolling.**Goldie & McCulloch Co. Ltd., Galt, Ont. *Advt.* 159.  
Bateman, Wm., Montreal, Que. *Advt.* page 247.**2114—MACHINES—Stud Setting.**Parmenter & Bulloch, Gananoque, Ont. *Advt.* 199.**2115—MACHINES—Stave, (Cylinder).***See No.* 2083.**2116—MACHINES—Shingle, (Horse Power).**

Joliette Foundry Co., Joliette, Que.

**2117—MACHINES—Clapboard Sawing.***See No.* 2110.**2118—MACHINES—Saw Setting, (Pat. Canadina).**Canadian Locomotive & Engine Co. Ltd., Kingston, Ont. *Advt.* page 175.**2119—MACHINES—Boot & Shoe.**Consigny, N., Quebec, Que.  
Drolet, F. X., Quebec, Que.  
Pettner, B. J., Montreal, Que.  
Kieffer Bros., Montreal, Que.**2120—MACHINES—(Flouiding), Spiral & Variety.**Goldie & McCulloch Co. Ltd., Galt, Ont. *Advt.* 159.  
Bertram, John & Sons, Dundas, Ont. *Advt.* p. 161.  
Robb Engineering Co. Ltd., Amherst, N.S.  
*See inside front cover.***2121—MACHINES—Dry Press Brick.**Goldie & McCulloch Co. Ltd., Galt, Ont. *Advt.* 159.**2122—MACHINES—Cloth Winding.***See No.* 2113.**2123—MACHINES—Edging Saw.**Goldie & McCulloch Co. Ltd., Galt, Ont. *Advt.* 159.  
Bertram, John & Sons, Dundas, Ont. *Advt.* page 161.  
Canadian Locomotive & Engine Co. Ltd., Kingston, Ont. *Advt.* page 175.**2124—MACHINES—Drag Saw, (Portable Cord Wood Sawing).**Moody, Matthew & Sons, Terrebonne, Que. *Advt.* 209.  
Chalifoux, O. & Sons, St. Hyacinthe, Que. *Advt.* 232.  
Young Bros., Almonte, Ont. *Advt.* page 250.  
Vessott, S. & Co., Joliette, Que. *Advt.* page 238.**2125—MACHINES—(Tinner's & Canners'), Crimping, Corrugating, Cornice, "De Cew & Carpenters", Power Copping, Bending, Burring, Forming, Flanging, Gutter, Notching, Tin Roofing, Rossing, Turning & Burring, Wiring, Soldering, Swaging, Seaming, Setting Down.**Brown, Boggs & Co., Hamilton, Ont. *Advt.* p. 193.**2126—MACHINES—Tenoning, Tonguing & Grooving.***See No.* 2073.**2127—MACHINES—(Leather), Glazing, Measuring, Splitting, Leather Polishing.**Lancaster Machine Works, Lancaster, Ont. *Advt.* 248.  
Bateman, Wm., Montreal, Que. *Advt.* page 247.  
Drolet, F. X., Quebec, Que.**2128—MACHINES—(Wood Boring).***See No.* 2072-3.**2129—MACHINES—Bending (Metal Working)**Bertram, John & Sons, Dundas, Ont. *Advt.* p. 161.**2130—MACHINES—(Threading), Bolt, Nut, Pipe.**Bertram, John & Sons, Dundas, Ont. *Advt.* p. 161.  
Butterfield & Co., Rock Island, Que.  
Jardine, A. B. & Co., Hespler, Ont. *Advt.* p. 217.**2131—MACHINES—Drilling.***See No.* 2112.**2132—MACHINES—Brick.**Goldie & McCulloch Co. Ltd., Galt, Ont. *Advt.* 159.  
Waterous Engine Works Co. Ltd., Brantford, Ont.  
Baird, H. C. & Son, Park Hill, Ont.**2133—MACHINES—Boring, Turning & Slotting, (Combined).***See No.* 2072.**2134—MACHINES—Rod, Pin & Dowel, Wood Polishing.***See No.* 2072.**2135—MACHINES—Gold Mining, Mining.**Ingersoll Rock Drill Co., Montreal, Que. *Advt.* 198.

- Truro Foundry & Machine Co. Truro, N. S. *Advt. page 198.*  
 Mac Machine Co., Belleville, Ont. *Advt. page 194.*  
 Robb Engineering Co. Ltd., Amherst, N. S. *See inside front cover.*  
 Jenckes Machine Co., Sherbrooke, Que. *Advt. 165.*
- 2136—MACHINES—Boring, Gang Boring, (Metal).**  
 Bertram, John & Sons, Dundas, Ont. *Advt. p. 161.*  
 Jackson, Cochrane & Co., Berlin, Ont.  
 Stevens, Hamilton & Co., Galt, Ont.  
 Gardner, Robt. & Son, Montreal, Que.
- 2137—MACHINES—(Moulding), Revolving Bed, Combined Moulding & Matching.**  
 Ballantine, John & Co., Preston, Ont. *Advt. p. 205.*
- 2138—See No. 2136.**
- 2139—MACKINTOSHES.**  
 Globe Rubber Co., Quebec, Que.  
 Mackenzie, J. W. & Co., Montreal, Que.
- 2140—MALLETS—Calking, Carpenters', Ice, Printers', Stone Cutters', Tanners'.**  
 Still, J. H., St. Thomas, Ont.  
 Goulette, O. V., Gananoque, Ont. *Advt. page 214.*  
 Strathroy, Mfg Co. Ltd., Strathroy, Ont.  
 McLeod Bros., Truro, N.S.  
 Wesley, F. J. & Co., Toronto Junction, Ont.
- 2141—MALT—Barley.**  
 Ambrose & Winslow Brewing & Malting Co. (The), Port Hope, Ont.  
 Clark, L. H. & Co., Kingston, Ont.  
 Cosgrave Brewing Co. Ltd., Toronto, Ont.  
 Cranston & Scringier, Galt, Ont.  
 Gooderham & Worts, Ltd., Toronto, Ont.  
 Holliday, Thomas, Guelph, Ont.  
 Matthews, W. D. & Co., Toronto, Ont.  
 McLaren, J. A., Perth, Ont.  
 Prescott Brewing & Malting Co., Prescott, Ont.  
 Spalding & Stewart, Perth, Ont.  
 Steele, James J., Greensville & Dundas, Ont.  
 Todd, Thomas & Son, Galt, Ont.  
 Walker Hiram & Sons, Ltd., Walkerville, Ont.  
 Wilson, M. S., Dundas, Ont.  
 Wisner, J. P. & Sons, Ltd., Prescott, Ont.
- 2142—MALT ALE.**  
 Parke, Davis & Co., Walkerville, Ont.
- 2143—MANDOLINS.**  
 Whaley, Royce & Co. (The), Toronto, Ont. *Advt. 189.*
- 2144—MANDRELS—Circular Saw.**  
 Bertram, John & Sons, Dundas, Ont. *Advt. p. 161.*  
 Goldie & McCulloch Co. Ltd., Galt, Ont. *Advt. 159.*  
 Matheson, I. & Co., New Glasgow, N.S. *Advt. 200.*  
 Carrier, Laine & Co., Levis, Que. *Advt. page 150.*  
 Bessette, J. & S., Iberville, Que.
- 2145—MANDRELS—Expanding, Taper.**  
 Butterfield & Co., Rock Island, Que.  
 Jardine, A. B. & Co., Hespeler, Ont. *Advt. p. 217.*
- 2146—MANGERS—Iron, Mangers & Hay Racks Combined. See No. 1831.**
- 2147—MANGLES—Laundry.**  
 Myers, W. F. & J. W., St. John, N.B. *Advt. 163.*

- Dowswell, Bros. & Co., Hamilton, Ont. *Advt. 243.*  
 Smart (James), Mfg Co. Ltd., Brockville, Ont. *Advt. page 178.*  
 Connor, J. H., Ottawa, Ont.
- 2148—MANHOLES & COVERS—Sewer, Street.**  
 Carrier, Laine & Co., Levis, Que. *Advt. page 150.*  
 Canada Pipe Foundry Co., Hamilton, Ont.  
 Garth & Co., Montreal, Que. *Advt. page 154.*  
 Three Rivers Iron Co., Three Rivers, Que. *Advt. 179.*
- 2149—MANHOLES—Concrete Stone.**  
 North Ebebezer, London, Ont.
- 2150—MANTELS—Terra Cotta.**  
 Rathbun Co. (The), Deseronto, Ont. *Advt. p. 162.*  
 Beamsville Pressed Brick Co., Beamsville, Ont. *Advt. page 215.*  
 Montréal Terra Cotta & Lumber Co., Montreal. *Advt. page 214.*
- 2151—MANTELS—Slate.**  
 New Rockland Slate Co., Montreal, Que. *Advt. 244.*  
 Burns & Co., Halifax, N. S.
- 2152—MANTELS—Radiator.**  
 Canadian Office & School Furniture Co. Ltd. (The), Preston, Ont. *Advt. page 210.*
- 2153—MANTELS—Over, Wood.**  
 Rathbun Co. (The), Deseronto, Ont. *Advt. page 162.*  
 Rhodes, Curry & Co. Ltd., Amherst, N. S. *Advt. 158.*  
 Webster Bros. & Parkes, Montreal, Que.  
 Snider, John B. Waterloo, Ont. *Advt. page 231.*  
 Rogers, Charles & Sons Co. Ltd., Toronto, Ont.  
 New York Mantel & Decorating Co., Montreal, Que.
- 2154—MAPS—School & Wall.**  
 Gage, (W. J.), Co. Ltd., Toronto, Ont. *Advt. page 189.*  
 Mortimer & Co., Ottawa, Ont.
- 2155—MARBLE—White, Blue, Flesh Colour.**  
 Bras D'Or Marble Co. Ltd. (The), Halifax, N. S.
- 2156—MARMALADE.**  
 Lefebvre, Michel & Co., Montreal, Que.
- 2157—MASHERS—Wood, Potato. See No. 2140.**
- 2158—MASHERS—(Wire), Vegetable.**  
 Davidson Mfg Co. Ltd. (Thos.), Montreal, Que. *Advt. page 225.*  
 Greening (The B.) Wire Co. Ltd., Hamilton, Ont.
- 2159—MASTS—Canoe.**  
 Canadian Canoe Co. Ltd., Peterboro, Ont.  
 Doherty, P., Collingwood, Ont.
- 2160—MANTLES—Ladies' Rubber.**  
 Globe Rubber Co. (The), Quebec, Que.
- 2161—MATCHERS—Box Board, Flooring, Rotary, (Matcher, Planer & Molder Combined).**  
 Goldie & McCulloch Co. Ltd., Galt, Ont. *Advt. 159.*  
 Carrier, Laine & Co., Levis, Que. *Advt. page 150.*  
 Cant Bros., Galt, Ont. *Advt. page 259.*  
 MacGregor, Gourlay & Co., Galt, Ont.  
 Mayo, W. S., Ottawa, Ont. *Advt. page 205.*
- 2162—MATCHES—Parlor & Sulphur.**  
 Independent Match Co., Louiseville, Que.

Hardy & Dubord, Beauport, Que.  
MacLaren Match Co. Ltd., Buckingham, Que.  
Moss Glen Mfg Co. Ltd., Moss Glen, N. B.  
Flewelling Mfg Co. (G. & G.), Hampton, N. B.  
Eddy Co. E. B., Hull, Que.

**2163—MATS—(Rubber), Bath, Coin, Cuspadore.** See No. 2170.

**2164—MATS—Rubber (Perforated), Weather Strips.**

Canadian Rubber Co., Montreal, Que. *Advt. p. 197.*

**2165—MATS—Oil Cloth.**

Dominion Oil Cloth Co., Montreal, Que. *Advt. 201.*

**2166—MATS—Cocoa, Door, Wool.** See No. 2171.

**2167—MATS—Lambskin.**

Peters, Wm., St. John, N.B.

**2168—MATS—(Door), Wire, Iron.**

Dennis, R., London, Ont. *Advt. page 207.*

Munro Bros., New Glasgow, N.S. *Advt. page 244.*

Meadows, Geo. B., Toronto, Ont.

**2169—MATS—Picture.**

Mathews, Bros. & Co., Toronto, Ont.

Woltz & McMahon, Toronto, Ont. *Advt. page 203.*

**2170—MATTING & MATS—(Rubber), Corrugated, Embossed, Smooth.**

Canadian Rubber Co., Montreal, Que. *Advt. p. 197.*

Gutta Percha & Rubber Mfg Co. Ltd., Toronto, Ont.

*See back cover.*

**2171—MATTING—Cocoa, Hemp, Jute, Napier, Lettered Door, Wool Border.**

Mitchell, William, Cobourg, Ont. *Advt. page 185.*

**2172—MATTOCKS—Edge, Pick.**

Welland Vale Mfg Co., St. Catharines, Ont. *Advt. 241.*

**2173—MATTRESSES—Wire, Woven Wire.**

Gale, George & Sons, Waterville, Que. *Advt. 258.*

Munro Bros., New Glasgow, N.S. *Advt. page 244.*

Hannah, John, St. John, N.B.

Knowles, Ham & Nott Co. Ltd., Brantford, Ont.

*Advt. page 220.*

Townshend, J. E. Montreal, Que. *Advt. page 247.*

Ives, H. R. & Co., Montreal, Que. *Advt. page 200.*

**2174—MATTRESSES—Spiral Spring.**

Knowles, Ham & Nott Co. Ltd., Brantford, Ont.

*Advt. page 220.*

**2175—MATTRESSES—(Woven Wire), Cuban, Oval.**

Gale, Geo. & Sons, Waterville, P.Q. *Advt. p. 258.*

**2176—MATTRESSES—Cotton, Excelsior, Fibre, Moss, Mixed, Wool, Sea Grass, Spring, Upholstered.**

Gale, Geo. & Sons, Waterville, Que. *Advt. p. 258.*

Ellis Furniture Co. (The), Ingersoll, Ont. *Advt. 208.*

Mealey, Thomas & Co., Hamilton, Ont. *Advt. 185.*

Hanover Spring Bed & Upholstering Co., Hanover, Ont.

Townshend, J. E., Montreal, Que. *Advt. page 247.*

Hutchings & Co., St. John, N. B.

**2177—MAULS—(Iron), Railroad, Ship.**

Gardner, (W. R.) Tool Co., Brockville, Ont.

Warnock, Jas. & Co., Galt, Ont.

Whitman & Barnes Mfg Co. (The), St. Catharines, Ont.

**2178—MEAL—Oat, Rolled Oats.**

Meldrum & McAllister, Peterboro, Ont. *Advt. 258.*

Wylie, James W., Almonte, Ont. *Advt. page 203.*

McKay Milling Co., Ottawa, Ont.

Tilson, E. D. Milling Co., Tilsonburg, Ont.

Thompson, Walter, Mitchell, Ont.

Ross, D. R., Embro, Ont.

Lipsey & Stickney, Elora, Ont.

Barclay, A., Toronto, Ont.

Wilson, James, Fergus, Ont.

Archibald Bros., Ingersoll, Ont.

Martin Bros., Mt. Forrest, Ont.

Goldie Milling Co., Ayr, Ont. *Advt. page 238.*

The Galt Milling Co., Galt, Ont.

Nairn, Stephen, Winnipeg, Man.

Lawson Bros., Toronto, Ont.

Martin & Warnock, Ottawa, Ont.

**2179—MEAL—Corn.**

Edwardsburg Starch Co., Montreal, Que. *Advt. 246.*

Wylie, James W., Almonte, Ont., *Advt. page 203.*

Martin & Warnock, Ottawa, Ont.

Goldie, James, Guelph, Ont. *Advt. page 238.*

Taylor, T. H. Co., Chatham, Ont. *Advt. page 236.*

Meldrum & McAllister, Peterboro, Ont. *Advt. p. 258.*

Goldie Milling Co., Ayr, Ont. *Advt. page 238.*

New Glasgow Milling Co., New Glasgow, N. S.

Calhoun, John R., St. John, N. B.

Cunningham & Curran, Halifax, N. S.

Fowler, W. H., St. John, N. B.

Lingham, W. H., Belleville, Ont.

McKay Milling Co., Ottawa, Ont.

Harper, George H., Dundas, Ont.

Sadler, Dundas & Flavelle Milling Co., Lindsay, Ont.

**2180—MEAL—Linseed.**

Weir & Weir, St. Mary's, Ont.

Levingston, J. & J., Baden, Ont.

Body & Noakes, Winnipeg, Man.

**2181—MEASURES—(Copper), Liquid.**

Parker, J. O. & Co., Toronto, Ont. *Advt. page 253.*

Macdonald & Co. Ltd., Halifax, N. S. *Advt. p. 256.*

Coulter & Campbell, Toronto, Ont. *Advt. page 201.*

Chadwick Bros., Hamilton, Ont. *Advt. page 206.*

Garth & Co., Montreal, Que. *Advt. page 154.*

American Copper Co., Toronto, Ont. *Advt. page 157.*

Booth Copper Co., Toronto, Ont. *Advt. page 155.*

**2182—MEASURES—Brass Yard, Counter.**

Woodyatt, A. R. & Co., Guelph, Ont. *Advt. page 207.*

McAvity, T. & Sons, St. John, N. B. *Advt. page 153.*

Cowan & Britton, Gananoque, Ont.

**2183—MEASURES—Wooden Dry.**

Smart, (Jas.) Mfg Co., Brockville, Ont. *Advt. p. 178.*

Magee Mfg Co. Ltd., London, Ont.

Gardner, W. R., Lyn, Ont.

**2184—MEAT—Mince.**

Clark, W., Montreal, Que.

Aylmer Canning Co., Aylmer, Ont.

McCormick Mfg Co. Ltd., London, Ont.

Delhi Fruit & Vegetable Canning Co., Delhi, Ont.

Wethy, J. H., St. Catharines, Ont.

**2185—MEAT—Mince, Condensed.**

Wethy, J. H., St. Catharines, Ont.

**2186—MEDALS—Exhibition, School, Society,  
University Prize, Agricultural Prize.**

Saunders, H. & A., Toronto, Ont.  
Bramley, Wm., Montreal, Que. *Advt. page 236.*  
Dewdney, A. H. & Bro., Toronto, Ont.  
Cox, Geo., Ottawa, Ont.  
Ellis, P. W. & Co. Toronto, Ont.  
Patterson & Heward, Toronto, Ont. *Advt. page 201.*  
Pritchard & Andrews, Ottawa, Ont. *Advt. page 250.*  
Dawson, G. W., Montreal, Que.  
Rolph, Smith & Co., Toronto, Ont.  
Cox, E. & Co., Montreal, Que.  
Fell, I. C. & Co., Toronto, Ont.

**2187—MEDICINES—Non-Secret.**

Stearns, Fred'k & Co., Windsor, Ont. *See back cover.*

**2188—MEMOS—Artistic.**

Allen, T. C. & Co., Halifax, N.S.

**2189—METAL—Crimped Sheet.** *See No. 2856.*

**2190—METAL—White.**

Peterborough Lock Co., Peterborough, Ont. *Advt. 219.*  
Garth & Co., Montreal, Que. *Advt. page 154.*

**2191—METALS—Journal Lining.**

Macdonald & Co. Ltd., Halifax, N.S. *Advt. p. 256.*  
Frankel Bros., Toronto, Ont. *Advt. page 255.*

**2192—METAL—Electrotype, Stereotype.**

Frankel Bros., Toronto, Ont. *Advt. page 255.*  
Harris, C. C., Toronto, Ont.  
Langwell, George & Son, Montreal, Que.

**2193—METAL—Babbitt.**

Ontario Lead & Bard Wire Co. Ltd., Toronto, Ont.  
*Advt. page 177.*  
Robertson, Jas. & Co., Toronto, Ont. *Advt. page 167.*  
Spooner, A. W., Port Hope, Ont.  
Vessot, S. & Co., Joliette, Que. *Advt. page 238.*  
Bertram, John & Sons, Dundas, Ont. *Advt. p. 161.*  
Harris, C. C., Toronto, Ont.  
Carrier, Laine & Co., Levis, Que. *Advt. page 150.*  
Dean, Thomas, Toronto, Ont.  
Macdonald & Co., Ltd., Halifax, N.S. *Advt. 256.*  
Young & Bro. Co. Ltd., Hamilton, Ont. *Advt. 257.*  
Frankel Bros., Toronto, Ont. *Advt. page 255.*  
Garth & Co., Montreal, Que. *Advt. page 154.*  
Mitchell, Robert & Co., Montreal, Que. *Advt. 213.*

**2194—METAL—Perforated.**

Greening Wire Co. (The B.), Hamilton, Ont.  
Munro Bros., New Glasgow, N.S. *Advt. page 244.*

**3195—METAL WORK—Structural.**

Central Bridge & Engineering Co. Ltd., Peterboro,  
Ont. *Advt. page 214.*

**2196—METERS—(Gas), Experimental & Sta-  
tion.**

Mitchell, Robert & Co., Montreal, Que. *Advt. 213.*

**2197—METERS—Alternating Current, Amp-  
ere, Electric, Registering, Volt.**

Kay Electric Works, Hamilton, Ont. *Advt. 233.*  
Royal Electric Co., Montreal, Que.  
Canadian General Electric Co. Ltd., Toronto, Ont.  
Toronto Electrical Works, Toronto, Ont

**2198—MILLS—Fanning, (Bag Attachment).**

Campbell, Manson, Chatham, Ont. *Advt page 252.*

**2199—MILLS—Rolling.**

Montreal Rolling Mills Co., Montreal, Que.  
*Advt. page 174.*  
Halifax Rolling Mills Co., Halifax, N. S.  
Abbott & Co., Montreal, Que. *Advt. page 196.*  
Ontario Rolling Mills, Hamilton, Ont.  
Nova Scotia Steel Co., New Glasgow, N. S.  
Burpee, L. & E. R., St. John, N. B.  
McDonell (The) Rolling Mills Co., Toronto, Ont.  
Pillow, Hearsey & Co., Montreal, Que.  
Portland Rolling Mills, St. John, N. B. *Advt. p. 195.*  
Peck Benny & Co., Montreal, Que.

**2200—MILLS—(Saw), Band, Circular, Gang.**

**2201—MILLS—Wind.**

Ontario Wind Engine & Pump Co., Toronto, Ont.  
*Advt. page 244.*  
McDougall, R. & Co., Galt, Ont. *Advt. page 199.*  
Donalson, Robert & Sons, Montreal, Que. *Advt. 251.*  
National Pump Works, Montreal, Que.  
Goold, Shapley & Muire Co. Ltd., Brantford, Ont.  
*Advt. page 191.*  
Goulette, O. V., Gananoque, Ont. *Advt. page 214,*  
Plews, D. & Co., Toronto, Ont.  
Bell, P. & Son, St. George, Ont.  
Robb Engineering Co. Ltd., Amherst, N. S.

*See inside front cover.*

Wortman & Ward Mfg Co., London, Ont.

**2202—MILLS—Corn Meal, Roller, Corn & Cob,  
Grist, Hominy, Pearl Barley.**

Goldie & McCulloch Co. Ltd., Galt, Ont. *Advt. 159.*

**2203—MILLS—Cider & Press, (Combined),  
Hand.**

Sleeper & Akhurst, Coaticook, Que. *Advt. p. 241.*

**2204—MILLS—(Clover), Thresher.**

Woon, R. & Co., Oshawa, Ont. *Advt. page 210.*

**2205—MILLS—Coffee, Paint.**

Smart (Jas.) Mfg Co., Brockville, Ont. *Advt. 178.*  
Ives, H. R. & Co., Montreal, Que. *Advt. page 200.*

**2206—MILLS—(Bone), Portable.**

Carrier, Laine & Co., Levis, Que. *Advt. page 150.*  
Robb Engineering Co. Ltd., Amherst, N.S.,  
*See inside front cover.*

**2207—MILLS—Spice.**

Todhunter, Mitchell & Co., Toronto, Ont.

**2208—MILLS—Bark.**

Carrier, Laine & Co., Levis, Que. *Advt. page 150.*  
Laurie Engine Co., Montreal, Que. *Advt. page 179.*  
Bateman, William & Co., Montreal, Que. *Advt. 247.*  
Goldie & McCulloch Co. Ltd., Galt, Ont. *Advt. 159.*  
Paxton, Tate & Co., Port Perry, Ont.  
Lancaster Machine Works, Lancaster, Ont. *Advt. 248.*  
Brush, Geo., Montreal, Que.

**2209—MILLS—(Wind), "Mallorytown".**

Goulette, O. V., Gananoque, Ont. *Advt. page 214.*

**2210—MILLS—(Wind), Pumping, Gearless,  
Sectional.** *See No. 2201.*

**2211—MILLS—Curd.**

McPherson, D. M., Lancaster, Ont.  
Lancaster Machine Works, Lancaster, Ont. *Advt. 248.*  
Richardson & Webster, St. Mary's, Ont.

**2212—MILLS—Quartz, Ore, Stamp.**

Jenckes Machine Co., Sherbrooke, Que. *Advt. 165.*  
 Fraser Bros., New Glasgow, N.S. *Advt. page 252.*  
 Matheson, I. & Co., New Glasgow, N.S. *Advt. 200.*

**2213—MILLS—Fanning.**

Campbell, Manson, Chatham, Ont. *Advt. page 252.*  
 McMurchie, A. & Co., Clinton, Ont.  
 Bessette, J. & S., Iberville, Que.  
 Young Bros., Almonte, Ont. *Advt. page 250.*  
 Chalifoux, O. & Sons, St. Hyacinthe, Que. *Advt. 232.*

**2214—MILLS—Fulling.**

Karch, H. W., Hespeler, Ont.  
 Young Bros., Almonte, Ont. *Advt. page 250.*

**2215—MILLS—Drag Saw, Portable, Rotary Saw.** *See Machines No. 2074-5.***2216—MILLS & BOLTERS—Lath (Combination).** *See No. 2075.***2217—MILLSTONES—Buhr.**

Chinic Hardware Co., Quebec, Que.

**2218—MIRRORS—Hand.**

Reinhard Mfg Co., Montreal, Que.  
 Carstens Mfg Co. (F.), Montreal, Que.

**2219—MIRRORS—Beveled, Cheval, Hall, Mantel, Plain, Toilet.**

Elliott & Son, Toronto, Ont.  
 Hobbs Mfg Co., London, Ont. *Advt. page 212.*  
 McCausland, Jos. & Son, Toronto, Ont.  
 Cobban Mfg Co. Ltd., Toronto, Ont.

**2220—MITTENS—Rubber.**

Canadian Rubber Co., Montreal, Que. *Advt. page 197.*

**2221—MITTS—Silk.**

Belding, Paul & Co. Ltd., Montreal, Que. *Advt. 183.*  
 Corticelli Silk Co., St. Johns, Que. *Advt. page 182.*

**2222—MITTS—Gauntlet.**

Bell & Co., Tilsonburg, Ont.

**2223—MITTS—Outseam.**

Hall, Jas. & Co., Brockville, Ont.

**2224—MITTS—Knitted, Gloves, Leggings.**

Eagle Knitting Co., Hamilton, Ont. *Advt. page 184.*  
 Hudson Bay Knitting Co., Montreal, Que.  
 Reiner, J. G., Wellesley, Ont.  
 Parks, William J. St. John, N. B.  
 Stanfield, C. E., Truro, N. S.

**2225—MOCCASINS—Leather, Buck, Elk, Moose, Beef, (Oil Tanned Lorigans).**

Hall, James & Co., Brockville, Ont. *Advt. p. 227.*  
 Crosby Co. (The H. H.), Hebron, N. S.  
 Casey, C. R., Amherst, N. S.  
 Vroom, C. N., St. Stephen, N.B. *Advt. page 257.*  
 Palmer, John, Fredericton, N.B.  
 Wright, A., Pembroke, Ont.  
 Wright, Edgar, Pembroke, Ont.

**2226—MOCCASINS—Baby Kid, Infant Chamois, Bead. Fancy, Indian, Eider down.**

Hall, James & Co., Brockville, Ont. *Advt. p. 227.*  
 Bastian, Maurice, Indian Lorette, Que.  
 Durand, Jos., Indian Lorette, Que.  
 Vincent, Philippe, Indian Lorette, Que.

Verret, James, Indian Lorette, Que.  
 Berrouard, Francois, Quebec, Que.  
 Balcer, Henry M., Three Rivers, Que.

**2227—MODELS—Drawing.**

Tees & Co., Montreal, Que.

**2228—MODELS—Manufactured.**

Newell, Aug. & Co., Toronto, Ont.

**2229—MODELS—Machinery, (Wood).**

Downer Pattern Co., Toronto, Ont. *Advt. p. 204.*

**2230—MOISTNERS—Envelope.**

Davidson Mfg Co. (Thos.), Montreal, Que. *Advt. 225.*

**2231—MOLASSES—Beet.**

Lefebvre, Michel & Co., Berthierville, Que.

**2232—MOLESKIN—Enamelled.**

Dominion Oil Cloth Co., Montreal, Que. *Advt. 201.*

**2233—MONOGRAMS—Harness.**

Garth & Co., Montreal, Que. *Advt. page 154.*  
 Peterboro Lock Co., Peterboro, Ont. *Advt. page 219.*  
 Pritchard & Andrews, Ottawa, Ont. *Advt. p. 250.*  
 Patterson & Heward, Toronto, Ont. *Advt. p. 201.*  
 Morrison James Brass Mfg Co., Toronto, Ont. *Advt. page 157.*

**2234—MONUMENTS—Bronze.**

White Bronze Monument Co., St. Thomas, Ont.

**2235—MONUMENTS—Granite, Marble, Polished Marble, (Marble Mantles), Head Stones, Slabs, Tomb Stones,**

Canadian Granite Co. Ltd., Ottawa, Ont.  
 Forsyth, R., Montreal, Que.  
 Hamilton Granite Works, Hamilton, Ont.  
 Gibson, Joseph G., Toronto, Ont.  
 Belanger, J. A., Quebec, Que.  
 Reid, Robert, Montreal, Que.  
 McIntosh, D. & Sons, Toronto, Ont.  
 Brunet, J., Cote des Neiges, Que.  
 Cintrat, A. R., Montreal, Que.

**2236—MOPS—Floor.**

Smart, (Jas.) Mfg Co., Brockville, Ont. *Advt. 178.*  
 Ives, H. R. & Co., Montreal, Que. *Advt. page 200.*

**2237—MOTORS—Electrical Power, Street Railway, Alternating, (Dynamos).**

Kay Electric Works, Hamilton, Ont. *Advt. page 233.*  
 Ahearn, & Soper, Ottawa, Ont.  
 Myers, W. F. & J. W., St. John, N. B. *Advt. 163.*  
 Canadian General Electric Co. Ltd., Toronto, Ont.  
 Royal Electric Co., Montreal, Que.

**2238—MOTORS—Battery, Electric, Factory, Fan, Printing House, Sewing Machine.**

Myers, W. F. & J. W., St. John, N. B. *Advt. p. 163.*  
 Robb Engineering Co. Ltd., Amherst, N. S.  
*See inside front cover.*

Ness, McLaren & Bate, Montreal, Que. *Advt. p. 240.*  
 Kay Electric Works, Hamilton, Ont. *Advt. page 233.*  
 Toronto Electric Motor Co., Toronto, Ont.  
 Ahearn & Soper, Ottawa, Ont.  
 Ballard Electric Works (The), Toronto, Ont.

**2239—MOTORS—Air.**

Ontario Wind Engine & Pump Co. Ltd., Toronto, Ont. *Advt. page 244.*

**2240—MOULDERS—Combined Endless Bed.**  
Ballantine, John & Co., Preston, Ont. *Advt. p. 205.*

**2241—MOULDINGS—Metal.**  
Metallic Roofing Co., Toronto, Ont. *Front Fly Leaf.*  
Garth & Co., Montreal, Que. *Advt. page 154.*  
Douglass Bros., Toronto, Ont. *Advt. page 204.*

**2242—MOULDINGS—Picture Frame, (Plain), Gilt.**  
Woltz & McMahon, Toronto, Ont. *Advt. page 203.*

**2243—MOULDINGS—Room, Wood, Furniture.**  
Rhodes, Curry & Co. Ltd., Amherst, N. S. *Advt. 158.*  
Edwards, W. C. & Co. Ltd., Ottawa, Ont. *Advt. 219.*  
Rathbun Co. (The), Deseronto, Ont. *Advt. page 162.*  
Gilmour & Co., Trenton, Ont.  
Gravel Lumber Co. Ltd. (The A.), Etchemin, Que. *Advt. page 215.*

Dodd, J. G., London, Ont.  
Woltz & McMahon, Toronto, Ont. *Advt. page 203.*  
Hawkesbury Lumber Co. Ltd., Hawkesbury, Ont.  
Gignac, O. & Sons, Quebec, Que.  
Paquet & Godbout, Montreal & St. Hyacinthe, Que.  
Copping, William, Joliette, Que.  
Gilmour & Hughson, Hull, Que.

**2244—MOULDINGS—Brass & Bronze.**  
Peterboro Lock Mfg Co., Peterboro, Ont. *Advt. 219.*

**2245—MOULDS—Cylinder.**  
Jenckes Machine Co., Sherbrooke, Que. *Advt. p. 165.*

**2246—MOULDS—Soap.**  
Patterson & Heward, Toronto, Ont. *Advt. page 201.*

**2247—MOULDS—Plasterer's.**  
Macdonald, J. K., Montreal, Que. *Advt. page 247.*

**2248—MOULDS—"Schott's" Button.**  
St. Lawrence Steel & Wire Co. Ltd., Gananoque, Ont. *Advt. page 183.*

**2249—MOULDS—(Wool), Button.**  
Lachute Shuttle & Bobbin Works, Lachute, Que.

**2250—MOULDS—Glass.**  
Dominion Glass Works, Montreal, Que. *Advt. 221.*

**2251—MOULDS—Solder.**  
Brown, Boggs & Co., Hamilton, Ont. *Advt. p. 193.*  
Young & Bro. Co. Ltd., Hamilton, Ont. *Advt. 257.*  
Morrison (James) Brass Mfg Co., Toronto, Ont. *Advt. page 157.*

**2252—MOULDS—Brick.**  
Goldie & McCulloch Co., Galt, Ont. *Advt. p. 159.*  
Walker, J. (Estate of), Toronto, Ont.

**2253—MOULDS—Butter.** *See No. 2641.*

**2254—MOULDS—Iron Cake.** *See No. 1739.*

**2255—MOULDS—Ingot.**  
Macdonald & Co. Ltd., Halifax, N.S. *Advt. p. 256.*  
Fraser Bros., New Glasgow, N.S. *Advt. page 252.*  
Matheson, I. & Co., New Glasgow, N.S. *Advt. 200.*

**2256—MOUNTINGS—Bell.**  
Peterboro Lock Mfg Co., Peterboro, Ont. *Advt. 219.*  
Garth & Co., Montreal, Que. *Advt. page 154.*

**2257—MOUNTINGS—Halter.**  
Skinner & Co., Gananoque, Ont. *Advt. page 255.*

**2258—MOUNTS—Photograph.**  
Ritchie & Ramsay, Toronto, Ont. *Advt. page 189.*  
Union Card & Paper Co. Montreal, Que. *Advt. 244.*

**2259—MOWERS—(Lawn), (Horse & Hand).**  
Woodyatt, A. R. & Co., Guelph, Ont. *Advt. p. 207.*  
Smart (James) Mfg Co., Brockville, Ont. *Advt. 178.*  
Gowdy Mfg Co., Guelph, Ont.  
Maxwell, David & Sons, St. Mary's, Ont. *Advt. 250.*

**2260—MOWERS—"Bell's" Improved.**  
Bell, B. & Son, St. George, Ont.

**2261—MOWERS—(Lawn), "Woodyatt", "Philadelphia".**  
Woodyatt, A. R. & Co., Guelph, Ont. *Advt. p. 207.*

**2262—MOWERS—Front Cut, Rear Cut.**  
Hamilton (Peter) Mfg Co., Peterboro, Ont. *Advt. page 209.*

Frost & Wood, Smith's Falls, Ont.  
Maxwell, David & Sons., St. Mary's, Ont. *Advt. 250.*  
Bell, B. & Son, St. George, Ont.  
Noxon Bros. Mfg Co., Ingersoll, Ont.  
Small & Fisher, Woodstock, N.B.  
Moody, Matthew & Sons, Terrebonne, Que. *Advt. 209.*  
Gowdy Mfg Co., Guelph, Ont.  
Sleeper & Akhurst, Coaticooke, Que. *Advt. p. 241.*  
Woon, Robert & Co., Oshawa, Ont. *Advt. p. 210.*

**2263—MUCILAGE.**  
McCrea & Hanes, Toronto, Ont. *Advt. page 248.*  
Edwards, C. M. & Co., Toronto, Ont.  
Auld, Edward, Montreal, Que.

**2264—MUCILAGE—Red Seal.**  
McCrea & Hanes, Toronto, Ont. *Advt. page 248.*

**2265—MUGS—Plated.**  
Simpson, Hall, Miller & Co., Montreal, Que. *Advt. page 203.*

**2266—MURIATE OF COPPER—Zinc.**  
Lyman Bros. & Co. Ltd., Toronto, Ont.

**2267—MURIATE OF IRON—Ammonia.**  
Canada Chemical Mfg Co. Ltd., London, Ont.  
Lyman Bros & Co., Toronto, Ont.

**2267 a—MUSIC—Sheet.**  
Whaley, Royce & Co., Toronto, Ont. *Advt. page 189.*

**2 68—MUSTARD—French.**  
Jonas, Henri & Co., Montreal, Que.  
Turner, Robert, Toronto, Ont.  
Mayell, I. M. & Co., London, Ont.

**2269—MUSTARD—Ground.**  
Ewing, S. H. & A. S., Montreal, Que. *Advt. p. 238.*  
Dunn, W. G. & Co., Hamilton, Ont.  
Bell Co. (The), St. John, N. B.

**2270—MUZZLES—Dogs, (Wire), Horse, Ox.**  
Dennis, R., London, Ont. *Advt. page 207.*  
Greening, (The B.), Wire Co. Ltd., Hamilton, Ont.

**2271—NAILS—(Cut), Barrel, Basket, Boat, Builders', Cigar Box, Galvanized, Fi-**

**nishing, Hob, Hungarian, Iron, Roofing, Shank, Shook, Sharp Pressed, Shingle, Slating, Steel.**

Abbott & Co., Montreal, Que. *Advt. page 196.*  
Graham Nail Works, Toronto, Ont.  
Cowan & Britton, Gananoque, Ont.  
Montreal Rolling Mills Co., Montreal, Que.

*Advt. page 174.*  
Portland Rolling Mills, St. John, N. B. *Advt. p. 195.*  
Chinic Hardware Co., Quebec, Que.  
Burpee, I. & E. R., St. John, N. B.

**2272—NAILS—Barbed, “Staples.”**

Ontario Lead & Barb Wire Co., Ltd., Toronto, Ont.  
*Advt. page 177.*

Ontario Tack Co. (The), Hamilton, Ont. *Advt. p. 180.*  
Montreal Rolling Mills Co., Montreal, Que.

*Advt. page 174.*  
Parmenter & Bulloch, Gananoque, Ont. *Advt. p. 199.*  
Dominion Wire Mfg Co. Ltd, Montreal, Que.  
Safety Barb Wire Co. Ltd., Toronto, Ont. *Advt. 180.*

**2273—NAILS—Horseshoe.**

Canada Horse Nail Co., Montreal, Que. *Advt. p. 213.*  
Abbott & Co., Montreal, Que. *Advt. page 196.*  
Montreal, Rolling Mills Co., Montreal, Que.

*Advt. page 174.*

**2274—**

**2275—NAILS—Picture, Tinned, Zinc.**

Montreal Rolling Mills Co., Montreal, Que.  
*Advt. page 174.*

**2276—NAILS—Clinch, Clout.**

Cowan & Britton, Gananoque, Ont.  
Montreal Rolling Mills Co., Montreal, Que.  
*Advt. page 174.*

Abbott & Co., Montreal, Que. *Advt. page 196.*  
Portland Rolling Mills, St. John, N. B. *Advt. p. 195.*  
Pender, James & Co. Ltd., St. John, N. B. *Advt. 208.*

**2277—NAILS—Brass Finishing, Copper Finishing, Lining, Trunk. Tufting, Saddle, Upholsters.**

Montreal Rolling Mills Co., Montreal. *Advt. p. 174.*  
Parmenter & Bulloch, Gananoque, Ont. *Advt. p. 199.*  
Gordon, J. J., St. John, N. B. *Advt. page 213.*  
Pender, James & Co., St. John, N. B. *Advt. p. 208.*  
Portland Rolling Mills, St. John, N. B. *Advt. p. 195.*  
Ontario Tack Co., Hamilton, Ont. *Advt. page 180.*

**2278—NAILS—(Wire), Barrel, Basket, Boat, Box, Builders, Car, Cigar Box, Fence, Flooring, Heel, Lath, Lining, Shoe, Shook, Sidewalk, Trunk.**

Canada Screw Co., Hamilton, Ont. *Advt. page 226.*  
Gordon, J. J., St. John, N. B. *Advt. page 213.*  
Montreal Rolling Mills Co., Montreal. *Advt. p. 174.*  
Ontario Tack Co. Ltd., Hamilton, Ont. *Advt. p. 180.*  
Ontario Lead & Barb Wire Co., Toronto, Ont.

*Advt. page 177.*  
Pender, James & Co. Ltd., St. John, N. B. *Advt. 208.*  
Portland Rolling Mills, St. John, N. B. *Advt. p. 195.*  
Safety Barb Wire Co. Ltd., Toronto, Ont. *Advt. 180.*  
Western Wire & Nail Co., London, Ont. *Advt. 177.*

**2279—NECKLACES—Diamond.**

Ellis, P. W. & Co., Toronto, Ont.

**2280—NECKLETS—Teething.**

Dorenwend Electric Belt Co., Toronto, Ont.

**2281—NECKTIES—Cotton, Silk, Neckwear.**

Niagara Neckwear Co., Niagara, Falls, Ont.  
Glover & Brais, Montreal, Que.  
Currie, E. & S., Toronto, Ont.

**2282—NEEDLES—Latch (Knitting Machine).**

Corey, William, Upper Bedford, Que.

**2282a—NEEDLES—Knitting Machine.**

Wheeler, Jas., Paris, Ont.

**2283—NESTS—Spice (Tin).**

Davidson Mfg Co., (Thos), Montreal, Que. *Advt. 225.*

**2284—NETS—(Woven), Horsefly, Tennis.**

Gendron Mfg Co. Ltd., Toronto, Ont. *Advt. p. 187.*  
Dovercourt Twine Mills Co. Ltd., Toronto, Ont.  
*Advt. page 184.*

**2285—NETTING—(Wire) Power Loom.**

Monro Bros., New Glasgow, N. S. *Advt. page 244.*

**2286—NETTING—Wire, Poultry Wire.**

Monro Bros., New Glasgow, N. S. *Advt. page 244.*  
Major Mfg Co., Montreal, Que.  
Greening, (The B.) Wire Co. Ltd., Hamilton, Ont.  
Meadows, Geo. B., Toronto, Ont.

**2287—NIPPERS—Cutting.**

Gillies, George Co., Gananoque, Ont. *Advt. p. 156.*  
Jardine, A. B. & Co., Hespeler, Ont. *Advt. page 217.*  
Brown, Boggs & Co., Hamilton, Ont. *Advt. page 193.*

**2288—NIPPLES—Breast (Rubber).**

Alpha Rubber Co. Ltd., Montreal, Que.

**2289—NIPPLES—Bicycle.**

Goold Bicycle Co., Brantford, Ont. *Advt. page 220.*  
Morrow, (John) Machine Screw Co., Ingersoll, Ont.  
*Advt. page 260.*

**2290—NIPPLES & NOZZLES—(Brass) Hose, Hydraulic.**

Garth & Co., Montreal, Que. *Advt. page 154.*  
Mitchell, Robert & Co., Montreal, Que. *Advt. p. 213.*  
Morrison, (Jas.) Brass Mfg Co., Toronto, Ont. *Advt. 157.*  
McAvity, T. & Sons, St. John, N. B. *Advt. page 153.*  
Hamilton Brass Mfg Co., Hamilton, Ont. *Advt. 168.*  
Macdonald & Co. Ltd., Halifax, N. S. *Advt. p. 256.*  
Parker, J. O. & Co., Toronto, Ont. *Advt. page 253.*  
Chadwick Bros., Hamilton, Ont. *Advt. page 206.*

**2291—NITRATE OF IRON—(True).**

Montreal Chemical Works, Montreal, Que.

**2292—NITRATE OF COPPER—Iron, Lead, Silver, Mercury, Magnesia, Potassium, Sodium.**

Canada Chemical Mfg Co. Ltd., London, Ont.  
Lyman Bros. & Co. Ltd., Toronto, Ont.  
Montreal Chemical Works, Montreal, Que.

**2293—NITRE—(Spirits of).**

Canada Chemical Mfg Co. Ltd., London, Ont.  
Kerry, Watson & Co., Montreal, Que.  
Lyman Sons & Co., Montreal, Que.  
Lyman Bros & Co. Ltd., Toronto, Ont.

**2294—NUMBERS—Metal, Door, Sign.**

Pritchard & Andrews, Ottawa, Ont. *Advt. page 250.*  
Hamilton Brass Mfg Co. Hamilton, Ont. *Advt. p. 168.*

- Mitchell, Robert & Co., Montreal, Que. *Advt.* 213.  
Patterson & Heward, Toronto, Ont. *Advt.* page 201.
- 2295—NURSERIES—Queen Bee.**  
Goold, Shapley & Muir Co., Brantford, Ont.  
*Advt.* page 191.  
Phillips, T. & Co., Orillia, Ont. *Advt.* page 259.  
Russell, W. G., Millbrook, Ont.
- 2296—NUTS—Top Prop.**  
McKinnon Dash & Hardware Co., St. Catharines, Ont.  
*Advt.* page 202.
- 2297—NUTS—Oblong, Sleigh Shoe, Sleeve.**  
Gillies, George Co., Gananoque, Ont. *Advt.* p. 156.  
Brown & Co., Paris, Ont.  
Canada Screw Co., Hamilton, Ont. *Advt.* page 226.
- 2298—NUTS—Case Hardened, Finished, Special.**  
Morrow Machine Screw Co. (John), Ingersoll, Ont.  
*Advt.* page 260.
- 2299—NUTS—Fish Plate, Railway Track,**  
*See No.* 2301.
- 2300—NUTS—Loop Head, Malleable Iron, Small Cast, Thumb.**  
Frost, W. H., Smith's Falls, Ont.  
Burrow, Stewart & Milne, Hamilton, Ont.  
Kyle, P., Merrickville, Ont.
- 2301—NUTS—Hexagon, Hot Pressed, Square, Tapped, Fish Plate, Railway Track.**  
Starr Mfg Co. Ltd., Halifax, N. S. *Advt.* page 199.  
Gillies George Co., Gananoque Ont. *Advt.* page 156.  
Brown & Co., Paris, Ont.  
Carrier, Laine & Co., Levis, Que. *Advt.* page 150.  
St. John Bolt & Nut Works, St. John, N. B.  
Canada Screw Co., Hamilton, Ont. *Advt.* page 226.  
Swansea Forging Co., Swansea, Ont. *Advt.* page 156.  
Ives, H. R. & Co., Montreal, Que. *Advt.* page 200.
- 2302—NUTS—Axle, Cold Punched.**  
Gillies, George Co., Gananoque, Ont. *Advt.* page 156.  
Canada Screw Co., Hamilton, Ont. *Advt.* page 226.
- 2303—NUTS—Machine Forged (Special Sizes).**  
Swansea Forging Co. Ltd., Swansea, Ont. *Advt.* 156.  
Gillies, George Co., Gananoque, Ont. *Advt.* p. 156.
- 2304—NUTS—Tapped.** *See No.* 2301.
- 2305—OARS—Sculling, Rowing.**  
Gilbert Boat Co., N., Brockville, Ont. *Advt.* page 254.  
Knapp, A. C., Kingston, Ont. *Advt.* page 229.  
Canadian Canoe Co. Ltd., Peterboro, Ont.
- 2306—OFFSETS.**  
Gillies, George Co., Gananoque, Ont. *Advt.* p. 156.  
Swansea Forging Co., Swansea, Ont. *Advt.* page 156.
- 2307—OIL—Cedar, Creosote.**  
Rathbun Co. (The), Deseronto, Ont. *Advt.* page 162.
- 2308—OIL—(Linseed), Boiled, Harness.**  
Imperial Oil Co., Petrolia, Ont. *Advt.* page 230.  
Rogers, Samuel & Co., Toronto, Ont. *Advt.* page 240.  
Ramsay, A. & Son, Montreal, Que. *Advt.* page 211.  
McArthur, Corneille & Co., Montreal, Que. *Advt.* 221.  
Hardy & Dubord, Beauport, Que.  
Levingston, J. & J., Baden, Ont.  
Baylis Mfg Co., Montreal, Que.
- 2309—OIL—Fusel, Sperm.**  
Lyman Sons & Co., Montreal, Que.  
Imperial Oil Co., Petrolia, Ont. *Advt.* page 230.
- 2310—OIL—Neatsfoot.**  
Harris, W. & Co., Toronto, Ont.  
Fox, T. M., Montreal, Que.  
Stuart, E. J., Montreal, Que.
- 2311—OIL—Sewing Machine.**  
Imperial Oil Co. Ltd., Petrolia, Ont. *Advt.* p. 230.  
Stearns, Frederick & Co., Windsor, Ont.  
*See back cover.*  
Rogers, Samuel & Co., Toronto, Ont. *Advt.* p. 240.
- 2312—OIL—Benzine, Farmers's Machine, Gasoline, Lard, Naptha, Tanners, Signal, Wool, Parraffine.** *See No.* 2313.
- 2313—OILS—Lubricating, Bicycle, Axle, Cylinder, Dynamo, Railway, Valve, Engine.**  
Imperial Oil Co. Ltd., Petrolia, Ont. *Advt.* p. 230.  
Rogers, Samuel & Co., Toronto, Ont. *Advt.* p. 240.  
Petrolia Oil Co., Petrolia, Ont.  
Fairbank, Rogers & Co., Petrolia, Ont.
- 2314—OIL—Olive, Olivine, Wool, Shoddiline, Spindle.** *See No.* 2313.
- 2314a—OIL—Soluble.**  
Cowan, John, Montreal, Que. *Advt.* page 240.
- 2315—OIL—Wine of Cod Liver "Stearns", (with peptonized Iron).**  
Stearns, Frederick & Co., Windsor, Ont. *See back cover.*
- 2316—OIL—Turkey Red.**  
Montreal Chemical Works, Montreal, Que.
- 2317—OILS—Fruit, Essential, Confectioners.**  
Lyman, Sons & Co., Montreal, Que.  
Evans & Sons, Montreal, Que.
- 2318—OIL—Improved Lofoten Cod Liver.**  
Parke, Davis & Co., Walkerville, Ont.
- 2319—OILS—Illuminating, Petroleum, (Crude Refined), Coal Oil, (Water White, Oxylene).**  
Imperial Oil Co. Ltd., Petrolia, Ont. *Advt.* p. 230.  
Fairbank, Rogers & Co., Petrolia, Ont.  
Petrolia Oil Co., Petrolia, Ont.
- 2320—OIL CLOTH—Carriage, Enamelled, Floor, Shelf, Stair, Table.**  
Dominion Oil Cloth Co., Montreal, Que. *Advt.* 201.
- 2321—OILERS—(Pocket), Bicycle.**  
Goold Bicycle Co. Ltd., Brantford, Ont. *Advt.* 220.
- 2322—OILERS—(Brass & Copper), Crank Pin, Engine.**  
American Copper Co., Toronto, Ont. *Advt.* p. 157.  
Garth & Co., Montreal, Que. *Advt.* page 154.  
Smart (James) Mfg Co., Brockville, Ont. *Advt.* 178.  
Booth Copper Co., Toronto, Ont. *Advt.* page 155.  
Hamilton Brass Mfg Co., Hamilton, Ont. *Advt.* 168.  
Pemberthy Injector Co., Windsor, Ont. *Advt.* 164.  
Parker, J. O. & Co., Toronto, Ont. *Advt.* page 253.  
Kerr Engine Co. Ltd., Walkerville, Ont. *Advt.* 208.



**2323—OINTMENT—Gileadine.**Rogers, Samuel & Co., Toronto, Ont. *Advt. p. 240.***2324—OINTMENT—Magic, Vegetable.**McCrea & Hanes, Toronto, Ont. *Advt. page 248.***2325—OINTMENTS—Hoof.**Rogers, Samuel Oil Co., Toronto, Ont. *Advt. p. 240.*  
McCrea & Hanes, Toronto, Ont. *Advt. page 248.***2326—OINTMENTS—Vaseline.**Cheseborough Mfg Co., Montreal, Que. *Advt. p. 259.***2327—OINTMENTS—Healing.**Stearns Fred'k & Co., Windsor, Ont. *See back cover.*  
Evans and Sons Ltd., Montreal, Que.  
Lyman Sons & Co., Montreal, Que.  
Kerry, Watson & Co., Montreal, Que.**2328—OINTMENTS—Mercurial, Petroleum, Witch Hazel.**

Lyman Sons &amp; Co., Montreal, Que.

**2329—OLEATES.**

Parke, Davis &amp; Co., Walkerville, Ont.

**2330—OPENERS—Can.**Smart, (Jas.) Mfg Co., Brockville, Ont. *Advt. p. 178.*  
Woodyatt, A. R. & Co., Guelph, Ont. *Advt. p. 207.*  
Robertson, E. & Co., Hamilton, Ont.  
Kyle, P., Merrickville, Ont.**2331—OPENERS—Envelope.**Smart, (Jas) Mfg Co., Brockville, Ont. *Advt. p. 178.***2332—ORGANS—Cabinet, Church, Parlor, Pipe, Reed.**Featherston Piano Co., Montreal, Que. *Advt. p. 228.*  
Pratte, L. E. N., Montreal, Que. *Advt. page 228.*  
Bell Organ & Piano Co. Ltd. (The), Guelph, Ont.  
Berlin Piano & Organ Co. Ltd., Berlin, Ont.  
Goderich Organ Co., Goderich, Ont.  
Peters, F. A. Jr., St. John, N. B.  
Greenwood, W. E., Toronto, Ont.  
Warren, S. R. & Son, Toronto, Ont.  
Lye, Edwards & Sons, Toronto, Ont.  
Casavant Bros., St. Hyacinthe, Que.  
Rowe, J. T., Aylmer, Ont.  
Brodeur, E., St. Hyacinthe, Que.  
Foisey, Thomas F. G., Montreal, Que.**2333—ORNAMENTS—Tower (Metal).**Dennis, R., London, Ont. *Advt. page 207.*  
Douglass Bros., Toronto, Ont. *Advt. page 204.*  
Metallic Roofing Co. of Canada Ltd.(The), Toronto, Ont. *See front fly leaf.***2334—ORNAMENTS—Dress, Mantle.**

Moulton &amp; Co., Montreal, Que.

**2335—ORNAMENTS—(Metal) Embossed.**Metallic Roofing Co. of Canada Ltd.(The), Toronto, Ont. *See front fly leaf.***2336—ORNAMENTS—Brass.**Chadwick Bros., Hamilton, Ont. *Advt. page 206.***2337—ORNAMENTS—Type (Printers').**

Toronto Type Foundry Co. Ltd., Toronto, Ont.

**2338—ORNAMENTS—Church.**American Copper Co., Toronto, Ont. *Advt. page 157.*

Lanctot, C. B., Montreal, Que.

**2339—ORNAMENTS—Stove, (Art Tile).**Campbell, R., Hamilton, Ont. *Advt. page 230.***2340—OTTOMANS. See Furniture.****2341—OUTFITS—Grain Stacking, Hay Stacking.**Laing, Ritchie & Co., Essex, Ont. *Advt. page 209.***2342—OUTFITS—Drive Well.**McKee & Marwick, Petrolia, Ont.  
Oil Well Supply Co., Petrolia, Ont.**2343—OVENS—Oil Stove, Camp Stove.**Davidson Mfg Co. (Thos.), Montreal, Que. *Advt. 225.*  
Smart (James) Mfg Co., Brockville, Ont. *Advt. 178.***2344—OVENS—Bakers' Portable, Stationary.**Toronto Portable Oven & Mfg Co. Ltd., Toronto, Ont.  
Gardner, Robert & Son, Montreal, Que.  
Fletcher Mfg Co., Toronto, Ont.  
Ives, H. R. & Co., Montreal, Que. *Advt. page 200.***2345—OVERGAITERS—Felt, Cloth.**Globe Rubber Co. (The), Quebec, Que.  
American Overgaiter Co. (The), Toronto, Ont.  
Cleland, A. & Sons, Toronto, Ont.  
Canadian Rubber Co., Montreal, Que. *Advt. p. 197.***2345 a—OXIDE OF MANGANESE.**Cowan, John, Montreal, Que. *Advt. page 240.***2346—OXIDE—Red.**Canada Paint Co., Montreal, Que. *Advt. page 221.*  
Ramsay, A. & Son, Montreal, Que. *Advt. page 211.*  
Henderson & Potts, Halifax, N.S.  
Dods, P. D. & Co., Montreal, Que.**2347—OXIDES—Iron, Red.**Canada Paint Co. Ltd., Montreal, Que. *Advt. 221.***2348—OXIDES—Copper, Silver, Iron, Sodium, Zinc.**

Lyman, Bros. &amp; Co. Ltd., Toronto, Ont.

**2349—OXIDES—Metallic.**Argall, J. & Sons, Three Rivers, Que.  
Dominion Paint Co., Dartmouth, N.S.**2350—OXGALL.,**

Lyman, Sons &amp; Co., Montreal, Que.

**2351—PACKERS—Bran & Flour. See No. 2765.****2352—PACKERS—Shingle.**Canadian Locomotive & Engine Co., Kingston, Ont. *Advt. page 175.*  
Hamilton Mfg Co. Ltd. (Wm.), Peterborough, Ont.  
Brown (G. & J.) Mfg Co., Belleville, Ont. *Advt. 198.***2353—PACKING—Engine, Piston, Rubber Back, Metallic, Fibrous, Self Vulcanizing**Clappison Pipe & Boiler Covering Co., Hamilton, Ont. *Advt. page 193.*  
Hamilton Engine Packing Co., Hamilton, Ont. *Advt. page 193.***2354—PACKING—Rubber Spiral.**Gutta Percha & Rubber Co., Toronto, Ont. *See back cover.*

- Canadian Rubber Co., Montreal, Que. *Advt. p. 197.*  
Toronto Rubber Co. Ltd. (The), Toronto, Ont.
- 2355—PACKING—Rope.**  
Lochrie, James, Toronto, Ont.
- 2356—PACKING—(Phoenix), Self Vulcanizing, Sheet.**  
Canadian Rubber Co., Montreal, Que. *Advt. p. 197.*
- 2357—PACKING—Rubber, Cloth Insertion, Gutta Percha Brand.**  
Toronto Rubber Co. Ltd. (The), Toronto, Ont.  
Gutta Percha & Rubber Co., Toronto, Ont.  
*See back cover.*
- 2358—PACKING—Plumbago, Pure Rubber.**  
Canadian Rubber Co., Montreal, Que. *Advt. p. 197.*  
Gutta Percha & Rubber Co., Toronto, Ont.  
*See back cover.*
- 2359—PACKING—Joint, Locomotive, Ring, Rod.** *See No. 2353.*
- 2360—PACKING—Hydraulic, Pump.**  
Hamilton Engine Packing Co., Hamilton, Ont.  
*Advt. page 193.*  
Clappison Pipe & Boiler Covering Co., Hamilton, Ont. *Advt. page 193.*  
McLaren Belting Co. (The J. C.), Montreal, Que.  
Eureka Mineral Wood & Asbestos Co., Toronto, Ont.  
*Advt. page 242.*  
Robin, Sadler & Haworth, Montreal, Que. *Advt. 226.*
- 2361—PACS—Shoe, (Oil Tanned).**  
Vroom, V. N., St. Stephen, N. B. *Advt. page 257.*  
Standard Boot Co. Ltd. (The), Quebec, Que.  
Palmer, John, Fredericton, N.B.  
Berrouard, Francois, Quebec, Que.
- 2362—PADDLES—Canoe.**  
Knapp, A. C., Kingston, Ont. *Advt. page 229.*  
Gilbert Boat Co. (N.), Brockville, Ont. *Advt. p. 254.*  
Canadian Canoe Co. Ltd., Peterboro, Ont.  
Paul, Thomas, Indian Lorette, Que.  
GrosLouis, Francis, Indian Lorette, Que.  
Sioui, Morice, Indian Lorette, Que.  
Dumas, Raphael, Indian Lorette, Que.
- 2363—PADLOCKS—Bicycle.**  
Goold Bicycle Co. Ltd., Brantford, Ont. *Advt. 220.*
- 2364—PADS—Desk Blotting, Writing.**  
Gage Co. Ltd. (W. J.), Toronto, Ont. *Advt. p. 189.*  
Brown Bros. Ltd. (The), Toronto, Ont.  
Morton, Phillips & Co., Montreal, Que.
- 2365—PADS—Bridge Collar.**  
Dominion Bridge Co. Ltd., Montreal, Que. *Advt. 195.*  
Loignon, A. & E., Montreal, Que. *Advt. page 247.*
- 2366—PADS—Teething.** *See No. 2869.*
- 2367—PADS—Truss.**  
Authors & Cox, Toronto, Ont.
- 2368—PADS—Step, (Metal).**  
Swansea Forging Co., Swansea Ont. *Advt. page 156.*  
Gillies, George Co., Gananoque, Ont. *Advt. p. 156.*
- 2369—PADS—Stair, (Patent Folded Paper).**  
Lazier, S. A., Belleville, Ont. *Advt. page 190.*
- 2370—PADS—Stair, Wadded.**  
Mealey, Thomas & Co., Hamilton, Ont. *Advt. p. 185.*
- 2371—PAILS—Dairy Milk, Galvanized Iron, Milk Strainer.**  
Davidson Mfg Co. Ltd. (Thos.), Montreal. *Advt. 225.*  
Chown, W. W. & Co., Belleville, Ont. *Advt. page 233.*  
Kemp Mfg Co., Toronto, Ont.
- 2372—PAILS—(Veneer), Honey, Ice Cream, Oyster.**  
Belleville Box & Basket Mfg Co., Belleville, Ont.  
*Advt. page 234.*  
Acme Veneer Works, Orillia, Ont. *Advt. page 217.*
- 2373—PAILS—(Fibreware) Factory, Fire, Railroad, Stable.**  
Eddy Co. Ltd. (E. B.), Hulls, Que.
- 2374—PAILS—Rubber.**  
Gutta Percha & Rubber Co., Toronto, Ont.  
*See back cover.*  
Canadian Rubber Co., Montreal, Que. & Toronto, Ont. *Advt. page 197.*  
Toronto Rubber Co. Ltd. (The), Toronto, Ont.
- 2375—PAILS—(Wooden) Candy, Horse, Jam, Mortar, Pickle, Pine, Syrup, Sap, Tobacco, Toy, Water, White Oak.**  
Cane & Sons Mfg Co. (Wm.), Newmarket, Ont.  
*Advt. p. 218.*
- 2376—PAILS—Stoneware (Butter).**  
Brantford Stoneware Mfg Co., Brantford, Ont.  
*Advt. page 251.*
- 2377—PAILS—Miner', (Iron).**  
Burpee, I. & E. R., St. John, N.B.
- 2378—PAILS—(Tin) Lard, Paint, Putty.**  
Macdonald Mfg Co., Toronto, Ont.  
Norton Mfg Co. (The), Hamilton, Ont.
- 2379—PAILS—Oyster (Paper).**  
Somerville, C. R., London, Ont. *Advt. page 235.*  
Brantford Box Co. (The), Brantford, Ont.  
Kilgour Bros., Toronto, Ont.
- 2280—PAILS—Leather.**  
Robin, Sadler & Haworth, Montreal, Que. *Advt. 226.*
- 2381—PAINTS—Iron Roof, Mixed, Roof, Bridge, Carriage, Fire Proof, Floor, Railway, Ship.**  
Canada Paint Co., Montreal, Que. *Advt. page 221.*  
Ramsay, A. & Son, Montreal, Que. *Advt. page 211.*  
Howe, William, Ottawa, Ont. *Advt. page 201.*  
Argall, J. & Sons, Three Rivers, Que.  
Henderson & Potts, Halifax, N. S.  
McArthur, Corneille & Co., Montreal, Que. *Advt. 221.*  
Baylis Mfg Co., Montreal, Que.  
Robertson Co. Ltd. (Jas.), Toronto, Ont. *Advt. 167.*  
Dominion Paint Co'y, Dartmouth, N. S.
- 2382—PAINTS—Bronze, Elastic, Enamel.**  
Howe, William, Ottawa, Ont. *Advt. page 201.*  
Henderson & Potts, Halifax, N. S.  
Canada Paint Co. Ltd., Montreal, Que. *Advt. p. 221.*  
Robertson Co. Ltd. (James), Toronto, Ont. *Advt. 167.*  
Robertson Co. Ltd. (Jas.), St. John, N. B. *Advt. 167.*

**2383—PAINTS—Face, (Vaseline, Theatrical).**  
Cheesebrough Mfg Co., Montreal, Que. *Advt.* 259.

**2384—PAINTS—Metallic, (Dry) Barrel, Wood Filler.**

Canada Paint Co., Montreal, Que. *Advt.* page 221.  
Robertson Co. Ltd. (Jas.), Toronto, Ont. *Advt.* 167.  
Howe, William, Ottawa, Ont. *Advt.* page 201.  
Dominion Paint Co'y, Darmouth, N. S.  
Ramsay, A. & Son, Montreal, Que. *Advt.* page 211.  
Argall, J. & Sons, Three Rivers, Que.  
McArthur, Corneille & Co., Montreal, Que. *Advt.* 221.

**2385—PAINTS—Copper.**

Dominion Paint Co'y, Darmouth, N.S.  
Henderson & Potts, Halifax, N.S.

**2386—PAINTS—Graphite.**

Canada Paint Co. Ltd., Montreal, Que. *Advt.* 221.

**2387—PAINTS—Churches, Dry Size Barrel, Wood Filler.**

Alabastine Co., Paris, Ont. *Advt.* page 212.

**2388—PANCREATIN—Pure Liquid, Saccharated.** *See No.* 1176.

**2389—PALLETES—Brick.**

Goldie & McCulloch Co. Ltd., Galt, Ont. *Advt.* 159.

**2390—PANELS—Door.**

Rathbun Co. (The), Deseronto, Ont. *Advt.* p. 162.

**2391—PANS—(Copper) Confectioners', Sauce, Stew.** *See Kettles No.* 1893.

**2392—PANS—Dry Clay.**

Goldie & McCulloch Co. Ltd., Galt, Ont. *Advt.* 159.

**2393—PANS—(Sheet Iron), Ore, Quartz, Salt Well, Sugar, Stove.**

Jenckes Machine Co., Sherbrooke, Que. *Advt.* 165.  
Carrier, Laine & Co., Levis, Que. *Advt.* page 150.

**2394—PANS—Bed, (Rockingham Ware).**

Campbell, R., Hamilton, Ont. *Advt.* page 230.  
Brantford Stoneware Co., Brantford, Ont. *Advt.* 251.

**2395—PANS—(Iron), Cake, Frying, Hatrack, Seamless, Umbrella.** *See No.* 1739.

**2396—PANTS—Rubber Fishing.**

Gutta Percha & Rubber Co., Toronto, Ont.  
*See back cover.*

**2397—PANTS—Cottonade, Overalls.**

Braime, T. E. & Co., Toronto, Ont.  
Goodhue, J. B., Rock Island, Que. *Advt.* page 236.

**2398—PAPER—Surfaced Sized Writing.**

Toronto Paper Mfg Co., Cornwall, Ont. *Advt.* 169.

**2399—PAPER—Asbestos.**

Schlater Asbestos Mfg Co., Montreal, Que. *Advt.* 172.  
Hopper, R. T. & Co., Montreal, Que. *Advt.* p. 239.  
Forrester, Thos., Montreal, Que. *See front fly leaf.*

**2400—PAPER—Wall.**

McArthur, Colin & Co., Montreal, Que. *Advt.* 191.  
Watson, Foster & Co., Montreal, Que. *Advt.* p. 211.  
Staunton, M. & Co., Toronto, Ont.

**2401—PAPER—Building, Dry Sheathing, Lining, Tarred, Waterproof.**

McArthur, Alex. & Co., Montreal, Que. *Advt.* 224.  
Reed, George W., Montreal, Que. *Advt.* page 237.  
Ford, J. & Co., Portneuf Station, Que. *Advt.* 191.  
Paterson Mfg Co., (The), Montreal, Que.  
Montreal Paper Co. (The), Portneuf, Que. *Advt.* 253.  
Reid, Craig & Co., Quebec, Que.  
Miller, Bros. & Co., Glen Miller, Ont. *Advt.* p. 192.

**2402—PAPER—Colored Writing, Engine Sized Writing.**

Buntin, Reid & Co., Toronto, Ont. *Advt.* page 170.  
Rolland Paper Co., Montreal, Que. *Advt.* page 189.  
Toronto Paper Mfg Co., Cornwall, Ont. *Advt.* 169.

**2403—PAPER—(Express), Water Proof.**

Imperial Water Proof Paper Co., Montreal, Que.

**2404—PAPER—Alkali Proof Soap Wrapping.**

Union Card & Paper Co. Ltd. (The), Montreal, Que.

**2405—PAPER—Book, Drug, Envelope, Music, Poster, Ticket, Tea.**

Barber, Wm. & Bros., Georgetown, Ont. *Advt.* 169.  
Buntin, Reid & Co., Toronto, Ont. *Advt.* page 170.  
Wilson, J. C. & Co., Montreal, Que.  
Royal Paper Mills Co., Montreal, Que.  
Canada Paper Co. Ltd., Montreal, Que.  
Toronto Paper Mfg Co. Cornwall, Ont. *Advt.* p. 169.  
Eddy Co. Ltd. (The E. B.), Hull, P. Q.  
Rolland Paper Co., Montreal, Que. *Advt.* page 189.  
Buntin, Alex. & Son, Montreal, Que.

**2406—PAPER—Bond, Machine Finish, Super Calender.**

Toronto Paper Mfg Co., Cornwall, Ont. *Advt.* 169.

**2407—PAPER—Fly.**

Stearns Fred'k & Co., Windsor, Ont. *See back cover.*  
Wilson, Archdale & Co. Hamilton, Ont.

**2408—PAPER—Gummed, Gummed Surface.**

Ritchie & Ramsay, Toronto, Ont. *Advt.* page 189.

**2409—PAPER—Tissue, Toilet.**

Canada Paper Co. Ltd., Montreal, Que.  
Wilson, J. C. & Co., Montreal, Que.  
Eddy Co. Ltd. (The E. B.), Hull, Que.  
Dominion Paper Co., Montreal, Que.

**2410—PAPER—Brown, Cover, Hardware, Trunk.**

Buntin, Reid & Co., Toronto, Ont. *Advt.* page 170.  
Ford, J. & Co., Portneuf Station, Que. *Advt.* p. 191.  
Canada Paper Co. Ltd., Montreal, Que.  
Buntin, Alex. & Son, Montreal, Que.  
Lazier, S. A. & Sons, Belleville, Ont. *Advt.* 190.  
Taylor Bros., Toronto, Ont.  
Lincoln Paper Mills Co. Ltd., Merriton, Ont.  
Royal Paper Mills Co., Montreal, Que.  
Wilson, J. C. & Co., Montreal, Que.  
Toronto Paper Mfg Co., Cornwall, Ont. *Advt.* 169.  
Montreal Paper Co., Portneuf, Que. *Advt.* page 253.

**2411—PAPER—Blotting.**

Buntin, Reid & Co., Toronto, Ont. *Advt.* page 170.  
McArthur, Alex. & Co., Montreal, Que. *Advt.* 224.  
Wilson, J. C. & Co., Montreal, Que.  
Buntin, Alex. & Son, Montreal, Que.

**2412—PAPER—Chromo, Drawing, Label, Lithograph.**

Barber, Wm. & Bros., Georgetown, Ont. *Advt. 169.*  
Buntin, Reid & Co., Toronto, Ont. *Advt. page 170.*  
Toronto Paper Mfg Co., Cornwall, Ont. *Advt. 169.*  
Ritchie & Ramsay, Toronto, Ont. *Advt. page 189.*  
Union Card & Paper Co., Montreal, Que. *Advt. 224.*  
Rolland Paper Co., Montreal, Que. *Advt. page 189.*

**2413—PAPER—News.**

Barber, Wm. & Bros., Georgetown, Ont. *Advt. 169.*  
Buntin, Reid & Co., Toronto, Ont. *Advt. page 170.*  
Ford, J. & Co., Portneuf Station, Que. *Advt. 191.*  
Fisher, John & Son, Dundas Ont.  
Dominion Paper Co., Montreal, Que.  
Thompson Paper Co. (The), Newburgh, Ont.  
Buntin, Alex. & Son, Montreal, Que.  
Riordon Paper Mills Ltd., Merriton, Ont.  
Eddy Co. Ltd., (The E. B.), Hull, Que.  
Taylor Bros., Toronto, Ont.

**2414—PAPER—Match Box.**

Ford, J. & Co., Portneuf Station, Que. *Advt. p. 191.*

**2415—PAPERS—Colored.**

Buntin, Reid & Co., Toronto, Ont. *Advt. page 170.*  
Barber, Wm. & Bros., Georgetown, Ont. *Advt. 169.*  
Buntin, Alex. & Son, Montreal, Que.  
Dominion Paper Co., Montreal, Que.

**2416—PAPERS—Enamelled, Glazed, Glazed Surface, Coated Book, Coated Chromo, Half Tone, Art, Tinted and Duplex Coated, Cover, Ticket.**

Union Card & Paper Co. Ltd. (The), Montreal, Que. *Advt. page 224.*  
Ritchie & Ramsay, Toronto, Ont. *Advt. page 189.*

**2417—PAPERS—Bank Note, Copying, Ledger, Writing.**

Rolland Paper Co., Montreal, Que. *Advt. page 189.*

**2418—PAPERS—News. See No. 3841.**

**2419—PAPERS—Carbon.**

Wilson, J. C. & Co., Montreal, Que.  
Underwood, John & Co., Toronto, Ont.

**2420—PAPERS—Linen.**

Rolland Paper Co., Montreal, Que. *Advt. page 189.*  
Toronto Paper Mfg Co., Cornwall, Ont. *Advt. 169.*

**2421—PAPERS—Sermon.**

Gage Co. Ltd. (W. J.), Toronto, Ont. *Advt. p. 189.*  
Brown Bros. Ltd. (The), Toronto, Ont.  
Morton, Phillips & Co., Montreal, Que.  
MacKinlay, A. W., Halifax, N.S.  
Barnes & Co., St. John, N.B.  
Allen, T. C. & Co., Halifax, N.S.

**2422—PAPERS—Note.**

Gage Co. Ltd. (W. J.), Toronto, Ont. *Advt. p. 189.*  
Buntin, Reid & Co., Toronto, Ont. *Advt. page 170.*

**2423—PAPERS—(Manilla) Bag, Tag, Wrapping. See No. 2410.**

**2424—PAPERS—Foolscap, Legal, Writing, Tub sized writing, Map.**

Gage Co. Ltd. (W. J.), Toronto, Ont. *Advt. p. 189.*

Rolland Paper Co., Montreal, Que. *Advt. page 189.*  
Buntin, Reid & Co., Toronto, Ont. *Advt. page 170.*

**2425—PAPERS—Hanging.**

Ford, J. & Co., Portneuf Station, Que. *Advt. p. 191.*  
Rolland Paper Co., Montreal, Que. *Advt. page 189.*  
Reid, Craig & Co., Quebec, Que.  
Domiuion Paper Co., Montreal, Que.

**2426—PAPERS — (Note) “ Abbotsford ”, “ Brookdale ”, “ Camden ”, “ St. Neots ”, “ Vancouver ”, “ Woronoco ”.**

Barber & Ellis Co. Ltd., Toronto, Ont. *Advt. 192.*

**2427—PAPERS—Typewriter.**

Rolland Paper Co., Montreal, Que. *Advt. page 189.*  
Eddy Co. Ltd. (E. B.), Hull, P. Q.

**2428—PAPETERIES.**

Gage Co. Ltd. (W. J.), Toronto, Ont. *Advt. p. 189.*  
Rolland Paper Co., Montreal, Que. *Advt. page 189.*  
Barber & Ellis Co. Ltd., Toronto, Ont. *Advt. 192.*  
Brown Bros. Ltd. (The), Toronto, Ont.  
Morton, Phillips & Co., Montreal, Que.

**2429—PAPETERIES—Abbotsford, Bath Velum, Brookdale, Scotch Standard, Confederation, Glendower Irish, Linen, Little Folk, Magnet, Plashwater.**

Barber & Ellis Co. Ltd., Toronto, Ont. *Advt. 192.*

**2430—PARAPHERNALIA & REGALIAS—Lodge.**

White, J. C., Hamilton, Ont.  
Dominion Regalia Co. (The), Toronto, Ont.

**2431—PARASOLS—(Carriage) Children.**

Gendron Mfg Co. Ltd., Toronto, Ont. *Advt. p. 187.*  
Montreal Suspender & Umbrella Mfg Co. (The), Montreal, Que.

**2432—PARERS—Fruit.**

Woodyatt, A. R. & Co., Guelph, Ont. *Advt. p. 207.*  
Davidson Mfg Co. (Thos), Montreal, Que. *Advt. 225.*

**2433—PARIS—Plaster of.**

Alabastine Co. Ltd. (The), Paris, Ont. *Advt. p. 221.*  
Rathbun Co. (The), Deseronto, Ont. *Advt. page 162.*

**2434—PARTS—Bicycle.**

Goold Bicycle Co. Ltd., Brantford, Ont. *Advt. 220.*  
Morrow Machine Screw Co. (John), Ingersoll, Ont. *Advt. page 260.*

**2434a—PARTS—(Bicycle) Rubber.**

Canadian Rubber Co., Montreal, Que. *Advt. p. 197.*  
“ “ “ Toronto, Ont.

**2435—PASTE—Axle (Vaseline).**

Chesebrough Mfg Co., Montreal, Que. *Advt. 259.*

**2436—PASTELS—Wood.**

Woltz & McMahon, Toronto, Ont. *Advt. page 203.*

**2437—PATTERNS—Wood, (Machinery).**

Downer Pattern Works, Toronto, Ont. *Advt. p. 204.*

**2438—PATTERNS—Lettered.**

Pritchard & Andrews, Ottawa, Ont. *Advt. page 250.*  
Patterson & Heward, Toronto, Ont. *Advt. p. 201.*

**2439—PEDALS—Piano.**

Woodyatt, A. R. & Co., Guelph, Ont. *Advt. p. 207.*  
Foisy, Thos. F. G., Montreal, Que.

**2440—PEDESTALS—Shaft.**

Fleck, Alex., Jr., Ottawa, Ont. *Advt. page 252.*  
Valleyfield Foundry & Machine Works., Valleyfield, Que. *Advt. page 191.*  
Gardner, Robert & Sons, Montreal, Que.  
Wilson, J. C. & Co., Glenora, Ont.

**2441—PEDALS & TREADS—Bicycle.**

Canadian Rubber Co., Montreal, Que. *Advt. p. 197.*  
Gould Bicycle Co. Ltd. (The), Brantford, Ont. *Advt. page 220.*  
Kingston Vehicle Co. Ltd., Kingston, Ont. *Advt. 202.*  
Gutta Percha & Rubber Mfg Co., Toronto, Ont. *See back cover.*

**2443—PEELS — Candied, Citron, Lemon, Orange.**

McCormick Mfg Co. Ltd., London, Ont.  
Tester, J. W. & Co., Montreal, Que.

**2444—PEGWOOD—Machine, Shoe Pegs.**

Lewis, J. & Sons, Truro, N.S.

**2445—PENDANTS — Diamond.**

Ellis, P. W. & Co., Toronto, Ont.

**2446—PENDANTS—Gas.**

American Copper Co. (The), Toronto, Ont. *Advt. 157.*  
Garth & Co., Montreal, Que. *Advt. page 154.*  
Parker, J. O. & Co., Toronto, Ont. *Advt. page 253.*  
Mitchell, Robt. & Co., Montreal, Que. *Advt. 213.*  
Young & Bro. Co. Ltd., Hamilton, Ont. *Advt. 257.*

**2447—PENSTOCKS—Turbine Wheel.**

Goldie & McCulloch Co., Galt, Ont. *Advt. p. 159.*  
Hamilton (Wm.), Mfg Co., Peterboro, Ont.  
Wilson, J. C. & Co., Glenora, Ont.

**2448—PEPPERS & SALTS—Plated.**

Simpson, Hall, Miller & Co., Montreal, Que. *Advt. page 203.*

**2449—PEPPER — (Ground) Black, White Cayenne.**

Pure Gold Mfg Co., Toronto, Ont.  
Snow Drift Co., Brantford, Ont.

**2450—PEPSINE.**

Stearns, Fred'k & Co., Windsor, Ont. *See back cover.*

**2451—PEPSIN ASEPTIC—Lactated, Liquid, Sacharated. See No. 1176.****2452—PERFUMERY.**

Lyman Bros. & Co. Ltd., Toronto, Ont.  
Stearns, Fred'k & Co., Windsor, Ont. *See back cover.*

**2453—PESSARIES—Rubber.**

Alpha Rubber Co. Ltd., Montreal, Que.

**2454—PEWS—Church, Pulpits, Collection Plates. See Seats No. 296.****2455—PHOSPHATES—Acid.**

Parke, Davis & Co., Walkerville, Ont.

**2456—PHOSPHATES — Acid (Powdered & Liquid).**

Canada Chemical Mfg Co. Ltd., London, Ont.

**2457—PIANOS—Upright, Square.**

Whaley, Royce & Co., Toronto, Ont. *Advt. 189.*  
Featherstone Piano Co. Montreal, Que. *Advt. p. 228.*  
Pratte, L. E. N., Montreal, Que. *Advt. page 228.*  
Foisy, Thos. F. G., Montreal, Que.  
Hoerr, H. & F. Toronto, Ont.  
Wormwith & Co., Kingston, Ont.  
Bell Organ & Piano Co. Ltd. (The), Guelph, Ont.  
Berlin Piano & Organ Co. Ltd., Berlin, Ont.

**2458—PICKERS — Burr, Feeder, Shoddy, Wool.**

Goldie & McCulloch Co. Ltd., Galt, Ont. *Advt. 159*  
Young Bros., Almonte, Ont. *Advt. page 250.*

**2459—PICKETS—Fence, Battens.**

Edwards, W. C. & Co. Ltd., Ottawa, Ont. *Advt. 219.*  
Copping, William, Joliette, Que.  
Pembroke Lumber Co., Pembroke, Ont. *Advt. p. 216.*  
Rathbun Co. (The), Deseronto, Ont. *Advt. page 162.*  
King Bros., Quebec, Que. *Advt. page 240.*  
Gilmour & Hughson, Hull, Que.  
Gignac, O. & Fils, Quebec, Que.  
Flewelling Mfg Co. (G. & G.), Hampton, N. B.  
Leigh, J. & Sons, Victoria, B. C.  
Truax, R. & Co., Walkerton, Ont.  
Gilmour & Co., Trenton, Ont.  
Breakey, John, Chaudiere Mills, Que.  
Moore, Fred & Sons, Woodstock, Ont.  
Red Cedar Lumber Co., Victoria, B. C.

**2460—PICKLES — Bulk, Mustard, Mixed, Sweet & Spiced.**

Lefebvre, Michel & Co., Montreal, Que.  
Lytle, T. A. & Co., Toronto, Ont.  
Hamilton Vinegar Works, Hamilton, Ont.  
Denne, Charles, Newmarket, Ont.  
Riverside Canning Works, Wallaceburg, Ont.

**2461—PICKS—Earth, Miners', Prospecting, Railroad, Quarry, Stone, Tamping.**

Whiting, (A. S.) Mfg Co., Oshawa, Ont. *Advt. p. 241.*  
Rixford, (O. S.) Mfg Co., Bedford, Que. *Advt. 241.*  
Welland Vale Mfg Co., St. Catharines, Ont. *Advt. 241.*  
Warnock, James & Co., Galt, Ont.  
Canada Axe & Harvest Tool Co., Cote St. Paul, Que. *Advt. page 241.*  
Gardner Tool Co. (W. R.), Brockville, Ont.  
Whitman & Barnes Mfg Co., St. Catharines, Ont.  
Wallace, William, Three Rivers, Que.

**2462—PIERS—Iron & Steel.**

Dominion Bridge Co., Montreal, Que. *Advt. p. 195.*  
Carrier, Laine & Co., Levis, Que. *Advt. page 150.*  
Central Bridge & Engineering Co. Ltd., Peterboro, Ont. *Advt. page 214.*  
Loignon, A. & E., Montreal, Que. *Advt. page 247.*

**2463—PILES—(Wood), Foundation, Pier.**

Vance, James, Hepworth Station, Ont. *See p. 256.*  
Murphy, J. E., Hepworth Station, Ont.  
Bottenhome, H., Clavering, Ont.  
Lawson, W. S., Park Head, Ont.  
White, E. I. & Son, Sand River, N.S.  
Colby, E. B., Hepworth Station, Ont.

**2464—PILLOIDS—Haemoferrum, Haemoglobin.**

Stearns, Fred'k & Co., Windsor, Ont. *See back cover.*

**2465—PILLOWS — Down, Feather, Hair, Wool.**

Gale, Geo. & Sons, Waterville, Que. *Advt. p. 258.*  
Ellis Furniture Co. (The), Ingersoll, Ont. *Advt. 208.*  
Townshend, J. E., Montreal, Que. *Advt. p. 247.*  
Thompson, D. W. & Co., Toronto, Ont.  
Hutchings & Co., St. John, N.B.  
Alaska Feather & Down Co. Ltd. Montreal, Que.

**2466—PILLOWS—Rubber Air, Bed Pans, Rubber.** *See No. 2869.*

**2467 —PILLS, S. C.—Blue, Coated, Compressed, Soluble, Vegetable, Granules.**

Stearns, Fred'k & Co., Windsor, Ont. *See back cover.*  
Lyman, Sons & Co., Montreal, Que.

**2468—PILLS — Quinine, Capsule Shaped Quinine.**

Parke, Davis & Co., Walkerville, Ont.

**2469—PILLS—Pink.**

Dr. William's Medicine Co., Brockville, Ont.

**2470—PINIONS—Iron & Steel.**

Robb Engineering Co. Ltd., Amherst, N.S.  
*See inside front cover.*  
Brown (G. & J.) Mfg Co., Belleville, Ont. *Advt. 198.*  
Gardner, Robert & Son, Montreal, Que.  
Carrier, Laine & Co., Levis, Que. *Advt. page 150.*  
Fraser Bros., New Glasgow, N.S. *Advt. page 252.*  
Laurie Engine Co., Montreal, Que. *Advt. page 179.*  
Loignon, A. & E., Montreal, Que. *Advt. page 247.*

**2471—PINS—Safety Spring.**

Montreal Suspender & Umbrella Mfg Co., Montreal.

**2472—PINS—Escutcheon (Brass, Iron, Steel), Hinge.**

Montreal Rolling Mills Co., Montreal, Que. *Advt. 174.*  
Parmenter & Bullock, Gananoque, Ont. *Advt. 199.*  
Canada Screw Co., Hamilton, Ont. *Advt. page 226.*  
Garth & Co., Montreal, Que. *Advt. page 154.*

**2473—PINS—(Jewelry), Cuff, Hair.** *See No 2805.*

**2474—PINS—Ribbon, Toilet.**

Garth & Co., Montreal, Que. *Advt. page 154.*  
MacGregor, Gourlay & Co., Galt, Ont.

**2475—PINS—Ten.**

May, Samuel & Co., Toronto, Ont.  
Reid Bros. & Co., Toronto, Ont.  
Ethier, E. L., Montreal, Que.

**2476—PINS—Wood Clothes.**

Cane & Sons Mfg Co. Ltd. (The Wm.), Newmarket, Ont. *Advt. page 218.*  
Eastman Lumber Co., Eastman, Que.

**2477—PINS—Clothes, (Spring).**

Brown, C. C., Danville, Que.

**2478—PINS—Insulator, Telegraph, Cross Arm**

Firstbrook Bros., Toronto, Ont.  
Rathbun Co. (The), Deseronto, Ont. *Advt. page 162.*

**2479—PINS—Belaying, (Ship).**

Frizzell, Alex., Halifax, N. S.  
Raney, Reid & Selby, Kingston, Ont.  
Bradley Bros., St. John, N. B.

**2480—PINS—Crank.**

Laurie Engine Co., Montreal, Que. *Advt. page 179.*  
Nova Scotia Steel Co. Ltd., New Glasgow, N. S.  
Lancaster Machine Works, Lancaster, Ont. *Advt. 248.*

**2481—PINS—Rolling.** *See No. 3591.*

**2481 a—PINS—Clothes, (Wire).**

LeBarron, G. A., Sherbrooke, Que.

**2482—PIPE—(Vitrified), Salt Glazed, Sewer, Drain, Culvert.**

Rathbun Co. (The), Deseronto, Ont. *Advt. p. 162.*  
Standard Drain Pipe Co., St. Johns, Que.

**2483—PIPE—Drive Well, Oil Line, Wrought Iron.**

Montreal Rolling Mills Co., Montreal, Que. *Advt. 174.*  
Hodgson, J. & C., St. Henry, Que.

**2484—PIPE—Lead, Tin Lined, (Lead).**

Robertson James Co. Ltd. (The), Montreal, Que. & Toronto, Ont. *Advt. page 167.*  
Ontario Lead & Barb Wire Co., Toronto, Ont.

*Advt. page 177.*  
Montreal Rolling Mills Co., Montreal, Que. *Advt. 174.*

**2485—PIPE—Concrete Stone, and Pavements**

Anthistle, W. J., London, Ont.  
North Ebenezer, London, Ont.

**2486—PIPE — (Cement) Culvert, Drain, Sewer.**

Vroom, C. N., St. Stephen, N.B. *Advt. page 257.*

**2487—PIPE—Water Works.**

Drummond, McCall Pipe Foundry Co. Ltd., Montreal, Que. *Advt. page 206.*  
Three Rivers Iron Works, Three Rivers, Que.

*Advt. page 179.*

Canada Pipe Foundry Co., Hamilton, Ont.  
St. Lawrence Foundry Co., Toronto, Ont.

**2488—PIPE—(Cast Iron) Culvert, Drain, Sewer, Pressure, "Rustless Iron", Soil, Gas, Flange, "Oil Well Tubing", T. Pipe, Pipe Elbows.**

Three Rivers Iron Works, Three Rivers, Que.  
*Advt. page 179.*

Garth & Co., Montreal, Que. *Advt. page 154.*  
Drummond, McCall & Co., Montreal, Que. *Advt. 206.*  
Canada Pipe Foundry Co., Hamilton, Ont.  
Fleck Alex. Jr., Ottawa, Ont. *Advt. page 252.*  
Young & Bro. Co. Ltd., Hamilton, Ont. *Advt. 257.*  
Ives, H. R. & Co., Montreal, Que. *Advt. page 200.*  
St. Lawrence Foundry Co., Toronto, Ont.  
Carrier, Laine & Co., Levis, Que. *Advt. page 150.*  
Toronto Foundry Co., Toronto, Ont.

**2489—PIPE—Copper.**

American Copper Co., Toronto, Ont. *Advt. p. 157.*  
Booth Copper Co., Toronto, Ont. *Advt. page 155.*  
Macdonald & Co. Ltd., Halifax, N.S. *Advt. p. 256.*  
Coulter & Campbell, Toronto, Ont. *Advt. page 201.*  
Parker, J. O. & Co., Toronto, Ont. *Advt. page 253.*  
Chadwick Bros., Hamilton, Ont. *Advt. page 206.*

**2490—PIPE—Galvanized Iron.** *See No. 2856.*

Metallic Roofing Co. (The), Toronto, Ont.  
*See Front Fly Leaf.*  
Montreal Rolling Mills Co., Montreal, Que. *Advt. 174.*

**2491—PIPE—Stove, Stove Pipe Elbows.**

Ives, H. R. & Co., Montreal, Que. *Advt. page 200.*  
Gurney, Tilden Co., Hamilton, Ont. *Advt. page 151.*  
Davidson Mfg Co. (Thos.), Montreal, Que. *Advt. 225.*  
Chown, W. W. & Co., Belleville, Ont. *Advt. 233.*  
Collins Mfg Co., Toronto, Ont.  
Patent Elbow Co. Ltd., Montreal, Que. *Advt. p. 171.*  
Kemp Mfg Co. Toronto, Ont.  
Chadwick Bros., Hamilton, Ont. *Advt. page 206.*

**2492—PIPE—Iron Riveted, Steel, Water Works, Stand.**

Carrier, Laine & Co., Levis, Que. *Advt. page 150.*  
Dominion Bridge Co. Ltd., Montreal, Que. *Advt. 195.*  
Central Bridge & Engineering Co. Ltd., Peterboro, Ont. *Advt. page 214.*  
Canadian Locomotive & Engine Co. Ltd., Kingston, Ont. *Advt. page 175.*  
Jenckes Machine Co., Sherbrooke, Que. *Advt. 165.*  
Patterson, John, Halifax, N. S.  
Goldie & McCulloch Co., Galt, Ont. *Advt. page 159.*

**2493—PIPE ELBOWS—Stove "Patent one piece".**

Patent Elbow Co. Ltd., Montreal, Que. *Advt. p. 171.*

**2494—PIPES—Flexible Play, (Rubber).**

Gutta Percha & Rubber Mfg Co., Toronto, Ont.  
*See back cover.*

**2495—PIPES—Chimney.**

Standard Drain Pipe Co., St. Johns, Que. *Advt. 251.*  
Brantford Stoneware Mfg Co., Brantford, Ont.  
*Advt. page 251.*

Glass Bros. & Co., London, Ont.

**2496—PIPES—Hawser, (Ships).**

Lunenburg Iron Co., Ltd., Lunenburg, N. S.

**2497—PIPES—Clay, Fancy Glaz.**

Bannerman Bros., Montreal, Que.

**2498—PIPES—(Conductor), Expansion, Galvanized Iron.**

Lessard & Harris, Montreal, Que. *Advt. page 231.*

**2499—PIPES—(Sheet Iron), Conductor.**

Metallic Roofing Co., Toronto, Ont. *See front fly leaf.*  
Gurney, Tilden Co. Ltd., Hamilton, Ont. *Advt. 151.*  
Lessard & Harris, Montreal, Que. *Advt. page 231.*  
Young & Bro. Co. Ltd., Hamilton, Ont. *Advt. 250.*  
Douglas Bros., Toronto, Ont. *Advt. page 204.*

**2500—PISTONS—Engine, Locomotive.**

Carrier, Laine & Co., Levis, Que. *Advt. page 150.*  
Canadian Locomotive & Engine Co. Ltd., Kingston, Ont. *Advt. page 175.*  
Matheson, I. & Co., New Glasgow, N.S. *Advt. 200.*  
Rathbun (The) Co., Deseronto, Ont. *Advt. p. 162.*

**2501—PITCH—Paving, Roofing.**

Rathbun Co. (The), Deseronto, Ont. *Advt. p. 162.*  
Dominion Paint Co., Dartmouth, N.S.  
Farr, J. H. & Co., Toronto, Ont. *Advt. page 211.*  
McArthur, Alex. & Co., Montreal, Que. *Advt. 224.*  
Reed, George W., Montreal, Que. *Advt. page 237.*  
Paterson Mfg Co. Ltd. (The), Montreal, Que.

**2502—PITCHERS—Plated.**

Simpson, Hall, Miller & Co., Montreal, Que.  
*Advt. page 203.*

**2503—PLACQUES—Brass.**

Chadwick Bros., Hamilton, Ont. *Advt. page 206.*

**2504—PLANES—Adjustable, Bead, Bench, Carpenters', Joiners', Iron Throat, Match, Moulding, Rabbet, Routing.**

Dyburgh, Jno., Bright, Ont.  
Emond, V. A., Quebec, Que.

**2505—PLANERS—Bed (Cut Gear), Endless, Single & Double Surface, Double Surface Pony, Comb, Planer and Matcher (Double Surface).**

Ballantine, John & Co., Preston, Ont. *Advt. p. 205.*

**2506—PLANERS—Crank, Frog & Switch, Locomotive, Rod, Metal Plate, Rotary.**

Gardner, Robert & Sons, Montreal, Que.  
Bertram, John & Sons, Dundas, Ont. *Advt. p. 161.*

**2507—PLANERS—Heading, Hoop, Stave.**

Goldie & McCulloch Co. Ltd., Galt, Ont. *Advt. p. 159.*  
McKeough & Trotter, Chatham, Ont.  
Lloyd Mfg Co., Kentville, N. S.

**2508—PLANERS—Emery.**

Hart Emery Wheel Co. Hamilton, Ont. *Advt. p. 166.*  
Prescott Emery Wheel Co., Prescott, Ont. *Advt. 237.*

**2509—PLANERS—Wood Buzz, Planers & Matchers, (Planer Matcher & Molder Combined).**

Goldie & McCulloch Co. Ltd., Galt, Ont. *Advt. p. 159.*  
Ballantine, John & Co., Preston, Ont. *Advt. p. 205.*  
Bertram, John & Sons, Dundas, Ont. *Advt. p. 161.*  
Cant Bros. & Co., Galt, Ont. *Advt. page 259.*  
Carrier, Laine & Co., Levis, Que. *Advt. page 150.*  
Robb Engineering Co. Ltd., Amherst, N. S.  
*See inside front cover.*

Lloyd Mfg Co., Kentville, N. S.

MacGregor, Gourlay & Co., Galt, Ont.

**2510—PLANTERS—Potato (Horse).**

Moody, Matthew & Sons, Terrebonne, Que.  
*Advt. page 209.*

**2511—PLANTERS—Corn, (Hand).**

Otterville Mfg Co. Ltd., Otterville, Ont. *Advt. 259.*  
Strathroy Mfg Co. Ltd. (The), Strathroy, Ont.

**2512—PLANTERS—Drill Marking Tobacco.**

Vessot, S. & Co., Joliette, Que. *Advt. page 238.*

**2513—PLANTS—Mining.**

Ingersoll Rock Drill Co., Montreal, Que. *Advt. p. 198.*  
Mac Machine Co., Belleville, Ont. *Advt. page 194.*  
Jenckes Machine Co., Sherbrooke, Que. *Advt. p. 165.*

**2513a—PLANTS—Rolling Mill. See No. 2199.****2514—PLANTS—Power, Steam.**

Babcock & Wilcox Co., Montreal, Que. *Advt. p. 194.*  
Goldie & McCulloch Co., Galt, Ont. *Advt. p. 159.*

**2515—PLANTS—Contractors.**

Beatty, M. & Sons, Welland, Ont. *Advt. page 173.*  
Brown (G. & J.), Mfg Co., Belleville, Ont. *Advt. 198.*

**2516—PLASTER—Calcined, Land, Paristone, Wall.**

Alabastine Co. Ltd. (The), Paris, Ont. *Advt. p. 212.*

Rathbun Co. (The), Deseronto, Ont. *Advt. page 162.*  
Albert Mfg Co., Hillsborough, N. B.  
Archibald, Samuel & Sons, Truro, N. S.

**2517—PLASTERS—Medicated.**

Lyman, Sons & Co., Montreal, Que.  
Kerry, Watson & Co., Montreal, Que.

**2518—PLATE—Ornamental Tin.**

Davidson Mfg Co. Ltd. (Thos.), Montreal, Que.  
*Advt. page 225.*

Macdonald Mfg Co., Toronto, Ont.  
Medonald Thomas Mfg Co., Montreal, Que.

**2519—PLATE—Boiler, (Printers').**

Stereotype Plate Co of Ont. Ltd., Toronto, Ont.

**2520—PLATES—Steel Roofing, Wall.**

*See No. 2856.*

**2521—PLATES—Ceiling & Floor, Expansion,  
Hook, Pipe Hook.**

Garth & Co., Montreal, Que. *Advt. page 154.*  
Young & Bros. Co. Ltd., Hamilton, Ont. *Advt. 257.*

**2522—PLATES—Finger & Guard, (Reaper &  
Mower).**

Whitman & Barnes Mfg Co., St. Catharines, Ont.

**2523—PLATES—Coffin.**

Globe Casket Co., London, Ont.

**2524—PLATES—(Iron), Bed, Stair.**

Gurney, Tilden Co., Hamilton, Ont. *Advt. p. 151.*  
Smart (James) Mfg Co., Brockville, Ont. *Advt. 178.*  
Mac Machine Co., Belleville, Ont. *Advt. page 194.*  
Ives, H. R. & Co., Montreal, Que. *Advt. page 200.*  
Garth & Co., Montreal, Que. *Advt. page 154.*  
Carrier, Laine & Co., Levis, Que. *Advt. page 150.*

**2525—PLATES—Dry.**

Anderson, Robinson & Co., Hamilton, Ont.  
Stanley Dry Plate Co., Montreal, Que.

**2526—PLATES—(Iron & Steel), Nail, Boiler.**

Montreal Rolling Mills Co., Montreal, Que.  
*Advt. page 174.*

Burpee, I. & E. R., St. John. N. B.  
Nova Scotia Steel Co. Ltd., New Glasgow, N. S.  
Portland Rolling Mills, St. John, N. B. *Advt. p. 195.*  
Abbott & Co., Montreal, Que. *Advt. page 196.*

**2527—PLATES—Angle.**

Bertram, John & Sons, Dundas, Ont. *Advt. p. 161.*  
Nova Scotia Steel Co. Ltd., New Glasgow, N. S.

**2528—PLATES—Bolster, (Waggon).**

Swansea Forging Co., Swansea, Ont. *Advt. page 156.*  
Smart, (Jas.) Mfg Co., Brockville, Ont. *Advt. p. 178.*

**2529—PLATES—Bridge.**

Dominion Bridge Co. Ltd., Montreal, Que. *Advt. 195.*  
Central Bridge & Engineering Co. Ltd., Peterboro,  
Ont. *Advt. page 214.*

Nova Scotia Steel Co. Ltd., New Glasgow, N. S.  
Stewart, John, New Glasgow, N. S. *Advt. page 222.*

**2530—PLATES—(Steel), Face.**

Bertram, John & Sons, Dundas, Ont. *Advt. p. 161.*  
Laurie Engine Co., Montreal, Que. *Advt. page 179.*  
Mac Machine Co., Belleville, Ont. *Advt. page 194.*  
Gardner, Rob't & Son, Montreal, Que.  
Fleck, Alex. Jr., Ottawa, Ont. *Advt. page 252.*

**2531—PLATES—Felloe.**

Parmenter & Bullock, Gananoque, Ont. *Advt. p. 199.*  
Frost, W. H., Smith's Falls, Ont.

**2532—PLATES—Fish, Railway Rail.**

Portland Rolling Mills, St. John, N. B. *Advt. p. 195.*  
Montreal Rolling Mills Co., Montreal, Que. *Advt. 174.*  
Nova Scotia Steel Co. Ltd., New Glasgow, N. S.

**2533—PLATES—Radiator Floor.**

Gurney Foundry Co. Ltd., Toronto, Ont.  
Young & Bro. Co. Ltd., Hamilton, Ont. *Advt. 257.*  
Mac Machine Co., Belleville, Ont. *Advt. page 194.*  
Star Iron Co., Montreal, Que. *Advt. page 243.*  
Garth & Co., Montreal, Que. *Advt. page 154.*

**2534—PLATES—Siding, (Steel).**

Nova Scotia Steel Co. Ltd., New Glasgow, N. S.  
Metallic Roofing Co. of Canada Ltd. (The), Montreal,  
Que. & Toronto, Ont. *See front fly leaf.*

**2535—PLATES—Stencil. See No. 1168.**

**2536—PLATES—Electrotypos, Electros.**

Lovell, Joseph, Montreal, Que.

**2537—PLATES—Stereotype.**

Central Press Agency, Toronto, Ont.  
Stereotype Plate Co. of Ontario Ltd., Toronto, Ont.

**2538—PLATES—Mirror.**

Ramsay, A. & Son, Montreal, Que. *Advt. page 211.*  
Cobban Mfg Co. Ltd., Toronto, Ont.  
Hobb's Mfg Co., London, Ont. *Advt. page 212.*

**2539—PLATES—Music. See No. 2267 a.**

**2540—PLATES—Bench, Floating.**

Brown, Boggs & Co., Hamilton, Ont. *Advt. p. 193.*

**2541—PLATES—Cesspool. See No. 1831.**

**2542—PLATES—Hinge.**

Dennis, R., London, Ont. *Advt. page 207.*

**2543—PLATES—Heel.**

Parmenter & Bulloch, Gananoque, Ont. *Advt. 199.*

**2544—PLATES—Die, Screw.**

Jardine, A. B. & Co., Hespeler, Ont. *Advt. p. 217.*  
Butterfield & Co., Rock Island, Que.

**2545—PLATES—(Brass) Carriage Name,  
Church Collection, Door, Letter Box,  
Memorial, Sign, Stair, Step.**

Garth & Co., Montreal, Que. *Advt. page 154.*  
McAvity, T. & Sons, St. John, N. B. *Advt. page 153.*  
Hamilton Brass Mfg Co., Hamilton, Ont. *Advt. 168.*  
Macdonald & Co. Ltd., Halifax, N. S. *Advt. page 256.*  
Chadwick Bros., Hamilton, Ont. *Advt. page 206.*  
Peterboro Lock Mfg Co., Peterboro, Ont. *Advt. 219.*  
Morrison Jas. Brass Mfg Co., Toronto, Ont. *Advt. 157.*  
Pritchard & Andrews, Ottawa, Ont. *Advt. p. 250.*  
Patterson & Heward, Toronto, Ont. *Advt. p. 201.*  
Fell, I. C. & Co., Toronto, Ont.

**2546—PLIERS—Wire.**

Ives, H. R. & Co., Montreal, Que. *Advt. page 200.*

**2547—PLOW JAWS.**

Frost, W. H., Smith's Falls, Ont.



**2548—PLOW—Railway Snow, (Steam).**

Rhodes, Curry & Co. Ltd., Amherst, N.S. *Advt. 158.*  
Crossen Car Mfg Co. Ltd., Cobourg, Ont. *Advt. 160.*  
Carrier, Laine & Co., Levis, Que. *Advt. page 150.*  
Rathbun Co. (The), Deseronto, Ont. *Advt. p. 162.*

**2549—PLOW—Cast, Contractors', Corporation, Ditching, Grading, Steel.**

Carrier, Laine & Co., Levis, Que. *Advt. page 150.*  
Stewart, John, New Glasgow, N.S. *Advt. page 222.*  
Wilkinson Plow Co. Ltd., Toronto, Ont.  
Hilborn, William, Ayr, Ont.  
Sleeper & Akhurst, Coaticook, Que. *Advt. page 241.*  
Waterloo Mfg Co. Ltd., Waterloo, Ont. *Advt. 218.*  
Dobbie & Stuart, Thorold, Ont.  
Joliette Foundry Co., Joliette, Que.

**2550—PLOW—Walking & Riding, Garden, Nursery, Cang, Sulky, Wheel Gang.**

*See No. 2551.*

**2551—PLOW—Shovel, Side Hill, Subsoil.**

Hamilton Mfg Co. (Peter), Peterboro, Ont. *Advt. 209.*  
Waterloo Mfg Co. Ltd., Waterloo, Ont. *Advt. p. 218.*  
Young Bros., Almonte, Ont. *Advt. page 250.*  
Maxwell, David & Sons, St. Mary's, Ont. *Advt. 250.*  
Gowdy Mfg Co., Guelph, Ont.  
Grout, John H. & Co., Grimsby, Ont.  
Frost & Wood, Smith's Falls, Ont.  
Coleman, T. T. (Estate of), Seaforth, Ont.  
Bell, B. & Son, St. George, Ont.  
Hilborn, William, Ayr, Ont.  
Sleeper & Akhurst, Coaticook, Que. *Advt. page 241.*  
Tollon Bros., Guelph, Ont.  
Gillies & Martin, Listowell & Teeswater, Ont.  
Wilkinson Plow Co. Ltd., Toronto Junction, Ont.  
McNeil, W. P. & Co., New Glasgow, N.S.  
Connell, Bros., Woodstock, N.B.  
Herring, John & Sons, Napanee, Ont.

**2552—PLUG—Rubber.**

Canadian Rubber Co., Montreal, Que. *Advt. p. 197.*

**2553—PLUG—Roll Paper.**

Lachute Shuttle & Bobbin Works, Lachute, Que. *Advt. page 188.*

**2554—PLUG—Cast Iron.**

Garth & Co., Montreal, Que. *Advt. page 154.*  
Morrison, (Jas.) Brass Mfg Co., Toronto, Ont. *Advt. page 157.*

**2555—PLUG—Brass, Deck, Fusible.**

Morrison, (Jas.) Brass Mfg Co., Toronto, Ont. *Advt. page 157.*  
McAvity, T. & Sons, St. John, N. B. *Advt. page 153.*  
Robb Engineering Co. Ltd., Amherst, N. S. *See inside front cover.*  
Parker, J. O. & Co., Toronto, Ont. *Advt. page 253.*  
Mitchell, Robert & Co., Montreal, Que. *Advt. p. 213.*  
Hamilton Facing Mill Co., Hamilton, Ont. *Advt. 193.*

**2555 a—PLUMBAGO.**

Dominion Foundry Supply Co., Montreal, Que. *Advt. page 266.*

**2556—POCKET—Bamboo Wall.**

Gendron Mfg Co. Ltd., Toronto, Ont. *Advt. p. 187.*  
American Rattan Co., Toronto, Ont.  
Thompson, Alex. & Co., Hamilton, Ont.  
Cobban Mfg Co. Ltd., Toronto, Ont.

**2557—Podophyllin.**

Lyman Sons & Co., Montreal, Que.

**2558—POINT—Washer.**

McDougall, R. & Co., Galt, Ont. *Advt. page 199.*

**2559—POINT—(Frog), Railway.**

Brown Mfg Co. Ltd. (G. & J.), Belleville, Ont. *Advt. page 198.*  
Canada Spring & Switch Mfg Co., Montreal, Que. *Advt. 217.*

**2560—POINT—Glaziers, Picture Frame.**

Ontario Tack Co. (The), Hamilton, Ont. *Advt. 180.*  
Portland Rolling Mills, St. John, N.B. *Advt. p. 195.*  
Montreal Rolling Mills Co., Montreal, Que. *Advt. 174.*

**2561—POINT—Brass Jacket, Drive Well.**

Otterville Mfg Co. Ltd., Otterville, Ont. *Advt. 259.*  
McDougall, R. & Co., Galt, Ont. *Advt. page 199.*  
McAvity, T. & Sons, St. John, N.B. *Advt. page 153.*  
Smart (Jas.) Mfg Co., Brockville, Ont. *Advt. p. 178.*

**2562—POINTERS—Hoop.**

McKeough & Trotter, Chatham, Ont.  
Park Bros., Chatham, Ont.

**2563—POISON—Bug.**

Common Sense Mfg Co., Toronto, Ont.

**2564—POKER—Firing, Stove & Shakers.**

*See No. 3316.*

**2565—POKER—Animal.**

Gardner, N. R., Lyn, Ont.  
Magee Mfg Co. Ltd., London, Ont.  
Still, J. H., St. Thomas, Ont.  
Strathroy Mfg Co. Ltd., Strathroy, Ont.

**2566—POLE—Pike.**

Wallace, Wm., Three Rivers, Que. *Advt. page 216.*  
Muckleston, J. & Co., Kingston, Ont.  
Crawford, W. C., Tilbury Centre, Ont.

**2567—POLE—(Wood), Curtain, Cornice.**

Still, J. H., St. Thomas, Ont.  
Cole's National Mfg Co., Ottawa, Ont.  
Wesley, F. J. & Co., Toronto, Junction, Ont.  
Cobban Mfg Co. Ltd., Toronto, Ont.  
Toronto Wholesale Lumber & Curtain Pole Co. The, Toronto, Ont.

**2568—POLE—Tent, Tent-Pins. *See No. 3591.***

**2569—POLE—Vehicle.**

Hore's F. W. Sons, Hamilton, Ont.

**2570—POLE—Brass Curtain.**

Hamilton Brass Mfg Co., Mamilton, Ont. *Advt. 168.*  
Morrison, (Jas.) Brass Mfg Co., Toronto, Ont. *Advt. page 157.*  
Parker, J. O. & Co., Toronto, Ont. *Advt. page 253.*

**2571—POLE—Telegraph.**

Rathbun Co. (The), Deseronto, Ont. *Advt. page 162.*  
King Bros., Quebec, Que.  
Klock, R. H. & Co., Aylmer, Que.  
Merick, S. S., Carleton Place, Ont.  
Sumner, Co., Moncton, N. B.  
Smith, J. F., Terra, Ont.  
Smith, W. E., Lennoxville, Que.  
Ray & Robinson, St. Cyrille, Que.  
McCaffrey, H. D., Orillia, Ont.

McRae Bros. & Co., Ottawa, Ont.  
 Morgan, J. D., Dundalk, Ont.  
 Leonard, M., Wickham West, Que.  
 Drummondville Lumber Co., Forestdale, Que.  
 Comtois & Co. Drummondville, Que.  
 Sadler, Dundas & Flavell Milling Co., Lindsay, Ont.  
 Clough, A. G., Ayers Flats, Que.  
 Colby, E. B., Hepworth Station, Ont.  
 Breakey, John, Chaudiere Mills, Que.  
 Beaudoin, Theo., Broughton, Que.  
 Blanchet, C., Broughton, Que.

**2572—POLES—(Iron), Electric Light, Trolley.**

Central Bridge & Engineering Co. Ltd., Peterboro, Ont. *Advt. page 214.*  
 Loignon, A. & E., Montreal, Que. *Advt. page 247.*  
 Ingersoll Rock Drill Co., Montreal, Que. *Advt. 198.*

**2573—POLISH—Stove Liquid, Stove Paste, Shoe, Tan.**

Domestic Specialty Co., Hamilton, Ont. *Advt. p. 227.*  
 McCrea & Hanes Co.(The), Toronto, Ont. *Advt. p. 248.*  
 Pure Gold Mfg Co., Toronto, Ont.  
 Dalley Co. Ltd. (F. F.), Hamilton, Ont.  
 Common Sense Mfg Co., Toronto, Ont.

**2574—POLISH—Furniture.**

Ramsay, A. & Son, Montreal, Que. *Advt. page 211.*

**2575—POLISH—Silverware.**

Standard Silver Co. Ltd., Toronto, Ont.  
 McCrea & Hanes Co., Toronto, Ont. *Advt. page 248.*  
 Simpson, Hall, Miller & Co., Montreal, Que. *Advt. 203.*  
 Felt, Bros., Oshawa, Ont.

**2576—PORK—(Barrel), Short Cut, Heavy, Mess & Shoulder Mess.**

**PORK, HAMIS—Short Cut, Long Cut, Manchester.**

**PORK, SHOULDERS—New York Cut, Square Cut.**

**PORK, BACON—Breakfast, Back, Dublin Cut, Long Clear, Rib, Roll, Wiltshire, Pure Lard.**

Mathews Co. Ltd. (Geo.), Peterboro, Ont. *Advt. 224.*  
 Ingersoll Packing Co. (The), Ingersoll, Ont.  
 Canada Packing Co., London, Ont.  
 Davies Co. Ltd. (The Wm.), Toronto, Ont.  
 Hovey Bros. Packing Co., Sherbrooke, Que.  
 Lawry, Thomas & Son, Hamilton, Ont.  
 Collingwood Meat Co. Ltd., Collingwood, Ont.  
 Fearman, F. W. & Sons, Hamilton, Ont.  
 Laing Packing & Provision Co., Montreal, Que.  
 Masterman, A. S. & W. H., Montreal, Que.  
 Park, Blackwell & Co., Toronto, Ont.  
 Whyte, John & Son, Mitchell, Ont.

**2577—PORK SAUSAGES—Bologna, Blood, Chicken, Ham, Liver, Pork & Tongue. Hog Casings, Hog Bladders. Pigs Heads, Pigs Feet, Pigs Jewel, Spiced Roll, Head Cheese.**

Mathews Co'y Ltd. (The Geo.), Peterboro & Ottawa, Ont. *Advt. page 224.*  
 Hovey Bros. Packing Co., Sherbrooke, Que.  
 Davies Co. Ltd. (The Wm.), Toronto, Ont.  
 Lawry, Thomas & Son, Hamilton, Ont.  
 Collingwood Meat Co. (The) Ltd., Collingwood, Ont.

Fearman, F. W. & Sons, Hamilton, Ont.  
 Clark, W., Montreal, Que.  
 Masterman, A. S. & W. H., Montreal, Que.  
 Park, Blackwell & Co. Ltd., Toronto, Ont.  
 Laing Packing & Provision Co., Montreal, Que.

**2578—PORTFOLIOS—Music, Sketch.**

Morton, Phillips & Co., Montreal, Que.  
 Brown Bros. Ltd. (The), Toronto, Ont.

**2579—POSTS—Cedar Fence.**

Dickson Co.(The), Peterboro, Ont. *Advt. page 250.*  
 Edwards, W. C. & Co., Ottawa, Ont. *Advt. page 219.*  
 Pembroke Lumber Co., Pembroke, Ont. *Advt. p. 216.*  
 Playfair, Jas. & Co., Midland, Ont. *Advt. page 223.*  
 Rathbun Co. (The), Deseronto, Ont. *Advt. page 162.*  
 Rhodes, Curry & Co., Amherst, N. S. *Advt. page 158.*  
 Vance, James, Hepworth Station, Ont. *Advt. p. 256.*  
 Copping, William, Joliette, Que.  
 Cookshire Mills Co., Cookshire, Que.  
 Allen, I., Mississippi Station, Ont.  
 Brunette Saw Mill Co. Ltd., New Westminster, B. C.  
 Canana Lumber Co. Ltd. (The), Carleton Place, Ont.  
 Cargill, H. & Son, Cargill, Ont.  
 Clough, A. G., Ayers Flats, Que.  
 Davidson, D., Penetanguishene, Ont.  
 Gilmour & Co., Trenton, Ont.  
 Leigh, J. & Sons, Victoria, B. C.  
 McLean & Son, Wingham, Ont.  
 McRae Bros. & Co., Ottawa, Ont.  
 McLachlin Bros., Arnprior, Ont.  
 Merick, S. S., Carleton Place, Ont.  
 McGibbon, F. & Sons, Penetanguishene, Ont.  
 Morgan, J. D., Dundalk, Ont.  
 Mason, Wm. & Sons, Ottawa, Ont.  
 Seaman & Newman, Warton, Ont.  
 Smith, J. F., Terra, Ont.  
 Sadler, Dundas & Flavell Milling Co., Lindsay, Ont.  
 Sumner Co., Moncton, N. B.  
 Thompson & Avery, Sharbot Lake, Ont.  
 Victoria Harbor Lumber Co., Victoria Harber, Ont.  
 Witthun, C. H. & Co., Hepworth, Ont.  
 White, A & P., Pembroke, Ont.  
 Young, William, Warton, Ont.

**2580—POSTS—Newel.**

Edwards, W. C. & Co., Ottawa, Ont. *Advt. p. 219.*  
 Rhodes, Curry & Co. Ltd., Amherst, N.S. *Advt. p. 158*  
 Rathbun Co.(The), Deseronto, Ont. *Advt. page 162.*  
 Gignac, O. & Fils, Quebec, Que.  
 Capital Planing Mill Co. Ltd., Ottawa, Ont.  
 Thackray, Robert, Ottawa, Ont.  
 Moffatt & Co., Carleton Place, Ont.  
 Storey, D., Ottawa, Ont.  
 Paquet & Godbout, Montreal, Que.  
 Robert, J. & Fils, Montreal, Que.  
 Christie, (The) Wood Working Co., St. John, N. B.  
 Risteen, Jos., & Co., Fredericton, N. B.  
 Dodd, John C. & Son, London, Ont.

**2581—POSTS—(Iron), Hitching, Stable Stall, "Post Heads".**

Woodyatt, A. R. & Co., Guelph, Ont. *Advt. p. 207.*  
 Tisdale Iron Stable Fitting Co. Ltd., Toronto, Ont. *Advt. page 202.*  
 Carrier, Laine & Co., Levis, Que. *Advt. page 150.*  
 Nichols, Thomas E., Hamilton, Ont.  
 Ives, H. R. & Co., Montreal, Que. *Advt. page 200.*

**2582—POSTS—(Iron), Fence, Gas, Hydrant, Lamp.**

Carrier, Laine & Co., Levis, Que. *Advt. page 150.*

- Brown (G. & J.), Mfg Co., Belleville, Ont. *Advt.* 198.  
 Young & Bro. Co. Ltd., Hamilton, Ont. *Advt.* p. 257.  
 Ives, H. R. & Co., Montreal, Que. *Advt.* page 200.  
 Goldie & McCulloch Co. Ltd., Galt, Ont. *Advt.* 159.
- 2583—POTASH—Ammoniated.**  
 Lyman Bros. & Co. Ltd., Toronto, Ont.
- 2584—POTASSIUM—Carbonate, Caustic Potash, Sulphate, Oxalate, Sulphuret.**  
 Canada Chemical Mfg Co. Ltd., London, Ont.  
 Lyman Bros. & Co. Toronto, Ont.
- 2585—POTASSIUM—Sulphuret.**  
 Lyman, Bros. & Co., Ltd., Toronto, Ont.
- 2586—POTS—(Rockingham Ware), Butter, Coffee, Cream, Stoneware, Tea, "Artistic Pottery", "Decorated Pottery".**  
 Campbell, R., Hamilton, Ont. *Advt.* page 230.  
 Brantford Stoneware Mfg Co. Ltd., Brantford, Ont. *Advt.* page 251.  
 Hart, Bros. & Lazier, Belleville, Ont. *Advt.* page 230.  
 Glass Bros. & Co., London, Ont.
- 2587—POTS—Glass.**  
 Lamont Glass Co., New Glasgow, N.S. *Advt.* p. 231.  
 Dominion Glass Co., Montreal, Que. *Advt.* page 221.
- 2588—POTS—Fire, (Cast Iron Charcoal).**  
 Brown, Boggs & Co., Hamilton, Ont. *Advt.* page 193.
- 2589—POTS—(Ore), Slag, Ore Shutes.**  
 Mac Machine Co., Belleville, Ont. *Advt.* page 194.  
 Brown (G. & J.), Mfg Co., Belleville, Ont. *Advt.* 198.  
 Weddell, R., Trenton, Ont.  
 Jenckes Machine Co., Sherbrooke, Que. *Advt.* 165.
- 2590—POTS—Coffee, (Plated).**  
 Chadwick Bros., Hamilton, Ont. *Advt.* page 206.
- 2591—POTS—(Tin), Marking.** *See No.* 1090.
- 2592—POTS—Bean, Earthen, Flower, Stone.**  
 Hart Bros. & Lazier, Belleville, Ont. *Advt.* page 230.  
 Glass Bros. & Co., London, Ont.  
 Farrar, E. L., Iberville, Que.  
 Foster, S. P & Co., Hamilton, Ont.  
 Brantford Stoneware Mfg Co., Brantford, Ont. *Advt.* page 251.
- 2593—POTS—(Cast Iron), Cooking, Glue, Soldering, Stove, Tinnerns' Fire.** *See No.* 1739.
- 2594—POUCHES—Music.**  
 Whaley, Royce & Co. Ltd., Toronto, Ont. *Advt.* v. 189.
- 2595—POUNDERS—Beefsteak, (Wood).** *See No.* 3591.
- 2596—POWDER—Baking.**  
 Ewing, S. H. & A. S., Montreal, Que. *Advt.* p. 238.  
 Century Co., Picton, Ont. *Advt.* page 246.  
 Snow Drift Co., Brantford, Ont.  
 Dunn, W. G. & Co., Hamilton, Ont.  
 Dalley Co. Ltd. (F. F.), Hamilton, Ont.  
 Pure Gold Mfg Co., Toronto, Ont.  
 Eagle Baking Powder Co., Montreal, Que. *Advt.* 257.
- 2597—POWDER—Baking, (Eagle).**  
 Eagle Baking Powder Co., Montreal, Que. *Advt.* 257.
- 2598—POWDER—Baking, "Vienna".**  
 Ewing, S. H. & A. S., Montreal, Que. *Advt.* p. 238.
- 2599—POWDER—Baking, "Newman's".**  
 Century Co., Picton, Ont. *Advt.* page 246.
- 2600—POWDER—Custard.**  
 Dunn, W. G. & Co., Hamilton, Ont.
- 2601—POWDER—Blasting, Flask, Giant, Gun**  
 Hamilton Powder Co., Montreal, Que. *Advt.* p. 196.  
 Acadia Powder Co. Ltd., Halifax, N.S. *Advt.* p. 240.
- 2602—POWDER—Asbestos.**  
 Sclater Asbestos Mfg Co., Montreal, Que. *Advt.* 172.
- 2603—POWDERS—Condition, Heave, Horse, Horse Worm.**  
 Stearns, Fred'k & Co., Windsor, Ont. *See back cover.*  
 Barber & Co., St. John, N. B.
- 2604—POWDERS—Bronze.**  
 Canada Paint Co., Montreal, Que., *Advt.* page 221.  
 Henderson & Potts, Halifax, N. S.
- 2605—POWDERS—Toilet.**  
 Lyman Sons & Co., Montreal, Que.  
 Kerry, Watson & Co., Montreal, Que.
- 2506—POWDERS—Soap.**  
 Savage, Alfred & Sons, Montreal, Que. *Advt.* p. 248.  
 Pure Gold Mfg Co., Toronto, Ont.
- 2607—POWERS—Horse "Pitts".**  
 Hamilton, (Peter) Mfg Co., Peterboro, Ont. *Advt.* 209.  
 Macpherson & Hovey Co., Clinton, Ont.  
 New Hamburg Mfg Co., New Hamburg, Ont.
- 2608—POWERS—(Horse), Threshing, Sweep, Tread.**  
 Moody, Matthew & Sons, Terrebonne, Que. *Advt.* 209.  
 Hamilton, (Peter) Mfg Co., Peterboro, Ont. *Advt.* 209.  
 Bell, B. & Son, St. George, Ont.  
 Macpherson & Hovey Co., Clinton, Ont.  
 Waterloo Mfg Co. Ltd., Waterloo, Ont. *Advt.* p. 218.  
 Bessette, J. & S., Iberville, Que.  
 Sleeper & Akhurst, Coaticook, Que. *Advt.* page 241.  
 Young Bros., Almonte, Ont. *Advt.* page 250.  
 Richardson & Webster, St. Mary's, Ont.  
 Sawyer & Massey Co. Ltd., Hamilton, Ont.  
 Chalifoux, O. & Sons, St. Hyacinthe, Que. *Advt.* 232.  
 Cantin, E., Warwick, Que.  
 Joliette Foundry Co., Joliette, Que.
- 2609—PREPARATIONS—Food, Special Medicinal.**  
 Parke, Davis & Co., Walkerville, Ont.
- 2610—PREPARATIONS—Effervescent, Granular, Beef.**  
 Parke, Davis & Co., Walkerville, Ont.
- 2611—PREPARATIONS—Cascara Bark, Kola Nut.**  
 Stearns, Fred'k & Co., Windsor, Ont. *See back cover.*
- 2612—PRESERVERS—Rubber Life.**  
 Canadian Rubber Co., Toronto & Montreal. *Advt.* 197.  
 Gutta Percha & Rubber Co., Toronto, Ont. *See back cover.*

**2613—PRESERVERS—Life (Canvass & Cork)**

Cork Co. of Canada Ltd., Toronto, Ont. *Advt. p. 187.*  
Montreal Tent, Awning & Tarpaulin Co., Montreal,  
Que. *Advt. page 232.*  
Leckie, J., Toronto, Ont.  
Doyle, J. E. & Co., Montreal, Que.  
Canada Cork Cutting Co., Montreal, Que. *Advt. 223.*  
Pike, D., Toronto, Ont. *Advt. page 182.*  
Preyseng, P. & Co., Toronto, Ont. *Advt. page 235.*  
Playfair, James & Co., Collingwood, Ont. *Advt. 223.*

**2614—PRESSERS—Cork,**

Smart (James) Mfg Co., Brockville, Ont. *Advt. 178.*  
Cork Co. of Canada, Toronto, Ont. *Advt. page 187.*

**2615—PRESERVES—Raspberry, Strawberry,  
Table Fruit.**

McCormick Mfg Co. Ltd., London, Ont.  
Delhi Fruit & Vegetable Canning Co., Delhi, Ont.  
Lefebvre, Michel & Co., Montreal, Que.

**2616—PRESSES—Hay, (Horse Power).**

Moody Matthew & Sons, Terrebonne, Que. *Advt. 209.*  
Bessette, J. & S., Iberville, Que.  
Chalifoux, O. & Sons, St. Hyacinthe, Que. *Advt. 232.*

**2617—PRESSES—Roller Copying.**

Office Specialty Mfg Co., Toronto, Ont.

**2618—PRESSES—Printing.**

Vivian, John H., Toronto, Ont.

**2619—PRESSES—Hay, "Detrick" Patent.**

Chalifoux, O & Sons, St. Hyacinthe, Que. *Advt. 232.*

**2620—PRESSES—Soap, Stamping.**

Myers, W. F. & J. W., St. John, N. B. *Advt. p. 163.*  
Brown, Boggs & Co., Hamilton, Ont. *Advt. page 193.*

**2621—PRESSES—Punching.**

Bertram, John & Sons, Dundas, Ont. *Advt. page 161.*  
Jardine, A. B. & Co., Hespeler, Ont. *Advt. page 217.*

**2622—PRESSES—Shingle.**

Canadian Locomotive & Engine Co., Kingston, Ont.  
*Advt. page 175.*  
Hamilton, (Wm.) Mfg Co., Peterboro, Ont.

**2623—PRESSES—Power (Sheet Metal).**

Brown, Boggs & Co., Hamilton, Ont. *Advt. page 193.*

**2624—PRESSES—Hydraulic.**

Matheson, I. & Co., New Glasgow, N.S. *Advt. 200.*  
Ontario Engine & Machine Co., Toronto, Ont.  
*Advt. page 177.*  
Bertram, John & Son, Dundas, Ont. *Advt. p. 161.*  
Carrier, Laine & Co., Levis, Que. *Advt. page 150.*  
Brush, Geo., Montreal, Que.  
Northey Mfg Co. Ltd., Toronto, Ont.

**2625—PRESSES—Drill.**

Bertram, John & Sons, Dundas, Ont. *Advt. p. 161.*  
Smart (Jas.) Mfg Co. Ltd., Brockville, Ont. *Advt. 178.*  
Jardine, A. B. & Co., Hespeler, Ont. *Advt. page 217.*  
Stevens, Hamilton & Co., Galt, Ont.  
Butterfield & Co., Rock Island, Que.

**2626—PRESSES—Copying.**

Bell, B. & Son, St. George, Ont.  
Smart (Jas.) Mfg Co. Ltd., Brockville, Ont. *Advt. 178.*  
Ives, H. R. & Co., Montreal, Que. *Advt. page 200.*

**2627—PRESSES—Cider & Wine.**

Lancaster Machine Works, Lancaster, Ont. *Advt. 248.*  
Hewett, R. & Son, Markham, Ont.  
Patterson, S. & Co., Toronto, Ont.  
Smart (Jas.) Mfg Co. Ltd., Brockville, Ont. *Advt. 178.*

**2628—PRESSES—Hydrostatic Wheel, Car  
Wheel, Shearing.**

Bertram, John & Sons, Dundas, Ont. *Advt. p. 161.*

**2629—PRESSES—Paper Bag, Single Cheese.**

McOuat & McRae, Lachute, Que. *Advt. page 205.*

**2630—PRESSES—(Sheet Metal), Bench, Em-  
bossing, Hand, Foot Lever, Metal Work-  
ing Machines.**

**Tinware Forming & Tacking.  
(Power) Blanking, Drawing, Forming,  
Shears, Metal Workers.**

Brown, Boggs & Co., Hamilton, Ont. *Advt. page 193.*

**2631—PRESSES—Can.**

Myers, W. F. & J. W., St. John, N. B. *Advt. p. 163.*

**2632—PRESSES—Brick, Tile.**

Goldie & McCulloch Co. Ltd., Galt, Ont. *Advt. p. 159*  
Baird, H. C. & Son, Park Hill, Ont.  
Bessette, J. & S., Iberville, Que.

**2633—PRESSES—Bailing Hydraulic.**

Brush, Geo., Montreal, Que.  
Matheson, I. & Co., New Glasgow, N. S. *Advt. p. 200.*

**2634—PRESSES—Wet (Pulp Mills).**

Jenckes Machine Co., Sherbrooke, Que. *Advt. p. 165.*

**2635—PRESSES—Box (Buggy Wheel).**

Jardine, A. B. & Co., Hespeler, Ont. *Advt. page 217.*

**2636—PRESSES—(Printing) Book, Card,  
Hand, Foot Power.**

Vivian, John H., Toronto, Ont.  
Westman & Baker, Toronto, Ont.

**2637—PRESSES—Gang, Cheese.**

Ashley Carriage Works, Belleville, Ont. *Advt. p. 204.*  
Carrier, Laine & Co., Levis, Que. *Advt. page 150.*  
Bessette, J. & S., Iberville, Que.  
Chown, W. W. & Co., Belleville, Ont. *Advt. page 233.*  
Brown, (G. & J.) Mfg Co., Belleville, Ont. *Advt. p. 198.*  
McOuat & McRae, Lachute, Que. *Advt. page 205.*  
Richardson & Webster, St. Mary's, Ont.

**2638—PRESSES—Cheese "Patent" Conti-  
nuous Gang.**

Richardson & Webster, St. Marys, Ont.

**2639—PRESSES & MOULDS—(Tobacco).**

Gardner, Rob't & Son, Montreal, Que.

**2640—PRIMERS—Powder.**

Dominion Cartridge Co., Montreal, Que. *Advt. p. 196.*

**2641—PRINTERS—Butter, Ladles & Moulds.**

Pearce, John S. & Co., London, Ont.  
McLaughlin, J., Ottawa, Ont.

**2642—PROGRAMMES—Entertainment.**

Allen, T. C. & Co., Halifax, N. S.

**2643—PROPS—Carriage Top.**

Gillies, George, Gananoque, Ont. *Advt. page 156.*  
Kile, P., Merrickville, Ont.  
McKinnon Dash & Hardware Co., St. Catharines,  
Ont. *Advt. page 202.*

**2644—PROTECTORS—Brass Counter.**

Garth & Co., Montreal Que. *Advt. page 154.*  
McAvity, T. & Sons, St. John, N. B. *Advt. page 153.*  
Hamilton Brass Mfg Co., Hamilton, Ont. *Advt. p. 168.*

**2645—PROTECTORS—Chest.**

Dorenwend Electric Belt & Truss Co., Toronto, Ont.

**2646—PROTECTORS—Skirt.**

Corticelli Silk Co. Ltd., St. Johns, Que. *Advt. p. 182.*

**2647—PRUNERS—Tree.**

Woodyatt, A. R. & Co., Guelph, Ont. *Advt. p. 207.*

**2648—PUBLICATIONS—Representative List  
of Canadian. See No. 3841.**

**2649—PULLERS—Stump.**

Dobbie & Stewart.

**2650—PRESSES—Fruit.**

Chown, W. W. & Co., Belleville, Ont. *Advt. p. 233.*  
Smart Mfg Co. (Jas.), Brockville, Ont. *Advt. p. 178.*

**2651—PUCKS—Hocket, (Rubber).**

Toronto Rubber Co. Ltd. (The), Toronto, Ont.

**2652—PULLERS—Cork.**

Robertson & Co., Hamilton, Ont.

**2653—PULLERS—Nail, Tack.**

Cowan & Britton, Gananoque, Ont.  
Smart (Jas.) Mfg Co., Brockville, Ont. *Advt. p. 178.*

**2654—PULLERS—Hammer & Nail, Combined**

Magnetic Hammer Co. (The), St. Hyacinthe, Que.

**2655—PULLEYS—"Iron Arm", Wood Split,  
Hub.**

Paxton, Tate & Co., Port Perry, Ont.

**2656—PULLEYS—Wood Split.**

Kerr & Morgan, Montreal, Que. *Advt. page 220.*  
Gardner, Robt. & Son, Montreal, Que.  
Miller Bros. & Toms, Montreal, Que. *Advt. p. 197.*  
Goldie & McCulloch Co. Ltd., Galt, Ont. *Advt. 159.*  
Matheson, I. & Co., New Glasgow, N.S. *Advt. 200.*  
Ontario Engine & Machine Co. Ltd., Toronto, Ont.  
*Advt. page 177.*  
Laurie Engine Co., Montreal, Que. *Advt. page 179.*  
Wilson, J. C. & Co., Glenora, Ont.  
Reid Bros. Mfg Co. of Toronto, Ltd., Toronto, Ont.  
Paxton, Tait & Co., Port Perry, Ont.  
Dodge Wood Split Pulley Co., Toronto, Ont.  
*Advt. page 259.*  
Robb Engineering Co. Ltd., Amherst, N.S.  
*See inside front cover.*

Reeves Pulley Co., Toronto, Ont.

**2657—PULLEYS—Wedge Rack.**

Jenckes Machine Co., Sherbrooke, Que. *Advt. p. 165.*  
Goldie & McCulloch Co. Ltd., Galt, Ont. *Advt. 159.*

**2658—PULLEYS—Furnace. See No. 2630.**

**2659—PULLEYS—Hay Carrier, (Wood).**

Dodd, J. G., London, Ont.  
McKeough & Trotter, Chatham, Ont.

**2660—PULLEYS—(Iron)—Clothes Line,  
Awning, Hay Fork, Hardware, Sash,  
Screw, Small Iron, Swivel.**

Garth & Co., Montreal, Que. *Advt. page 154.*  
Ives, H. R. & Co., Montreal, Que. *Advt. page 200.*  
Rrush, Geo., Montreal, Que.  
Smart, (Jas.) Mfg Co., Brockville, Ont. *Advt. p. 178.*  
Woodyatt, A. R. & Co., Guelph, Ont. *Advt. p. 207.*  
Peterboro Lock Mfg Co., Peterboro, Ont. *Advt. p. 219.*  
Brown, (G. & J.) Mfg Co., Belleville, Ont. *Advt. p. 198.*  
Burrow, Stewart & Milne, Hamilton, Ont.  
McOuatt & McRae, Lachute, Que. *Advt. page 205.*  
Robb Engineering Co. Ltd., Amherst, N. S.

*See inside front cover.*

Young, Andrew, Montreal, Que. *Advt. page 248.*  
Vidal Fils & Cie., Quebec, Que. *Advt. page 205.*

**2661—PULLEYS—(Iron), Balanced Clutch,  
Cone, Flanged Friction Clutch, Grip,  
Grooved, Guide, Special.**

Carrier, Laine & Co., Levis, Que. *Advt. page 150.*  
Matheson, I. & Co., New Glasgow, N. S. *Advt. p. 200.*  
Brush, Geo., Montreal, Que.  
Ontario Engine & Machine Co. Ltd., Toronto, Ont.  
*Advt. page 177.*

Burrell, Johnson Iron Co., Yarmouth, N. S.  
Fraser Bros., New Glasgow, N. S. *Advt. page 252.*  
Fleck, Alex. Jr., Ottawa, Ont. *Advt. page 252.*  
Miller Bros. & Toms, Montreal, Que. *Advt. page 197.*  
Parker, Moses, Montreal, Que. *Advt. page 197.*  
Valleyfield Foundry & Machine Works, Valleyfield,  
Que. *Advt. page 191.*

Laurie Engine Co., Montreal, Que. *Advt. page 179.*  
Waterous Engine Works Co. Ltd., Brantford, Ont.  
Kerr & Morgan, Montreal, Que. *Advt. page 220.*  
Bertram, John & Sons, Dundas, Ont. *Advt. page 161.*  
MacDonald & Co. Ltd., Halifax, N. S. *Advt. page 256.*  
Nie & Whitfield, Hamilton, Ont.  
Three Rivers Iron Works, Three Rivers, Que.

*Advt. page 179.*

Robb Engineering Co. Ltd., Amherst, N. S.

*See inside front cover.*

Wilson, J. C. & Co., Glenora, Ont.  
Lancaster Machine Works, Lancaster, Ont. *Advt. 248.*

**2662—PULLS—Bell, Door, Drawer, Escut-  
cheon.**

Garth & Co., Montreal, Que. *Advt. page 154.*  
Peterboro Lock Mfg Co., Peterboro, Ont. *Advt. 219.*  
Woodyatt, A. R. & Co., Guelph, Ont. *Advt. page 207.*  
Smart (Jas.) Mfg Co., Brockville, Ont. *Advt. p. 178.*  
Ives, H. R. & Co., Montreal, Que. *Advt. page 200.*  
Chadwick Bros., Hamilton, Ont. *Advt. page 206.*

**2663—PULP—Sulphite Fibre Wood.**

Maritime Sulphite Fibre Co. Ltd., Chatham, N.B.

**2664—PULP—(Chemical Fibre) Wood.**

Barber, Wm. & Bros., Georgetown, Ont.  
Fisher, John & Son, Dundas, Ont.  
Dominion Paper Co., Montreal, Que.  
Davy James, Thorold Pulp Mills, Thorold, Ont.  
Jackson, Thomas L., St. Raymond, Que.  
Souay, Florentin, St. Antonin, Que.  
Buckingham Mfg Co. Ltd., Buckingham, Ont.

Riordon Paper Mills Ltd., Merriton, Ont.  
Maritime Sulphite Fibre Co., Chatham, N.B.

**2665—PULP—Wood.**

Ford, J. & Co., Portneuf Station, Que. *Advt. p. 191.*  
Sitt, James & Sons, West Flamboro, Ont.  
Miller, Bros. & Co., Glen Miller, Ont. *Advt. p. 192.*  
Morgan Falls Pulp Co., Morgan Falls, N.S.  
Hamelin & Ayers, Lachute Mills, Que. *Advt. p. 188.*  
Laurentide Pulp Co., Grand Mere, Que.  
Buntin, Alex. & Son, Montreal, Que.  
Nova Scotia Wood Pulp & Paper Co. Ltd., Mill  
Village, N. S.  
Sills Bros., Frankford, Ont.  
St. Ursule Pulp Mill, St. Ursule, Que.

**2666—PULP—Asbestine.**

Sclater Asbestos Mfg Co. (The), Montreal, Que.  
*Advt. page 172.*

**2667—PULPERS—Root.**

Waterloo Mfg Co. Ltd., Waterloo, Ont. *Advt. p. 218.*  
Hamilton (Peter) Mfg Co., Peterborough, Ont.  
*Advt. page 209.*  
Walker Co'y. (The), Belleville, Ont.  
Maxwell, David & Sons, St. Mary's, Ont. *Advt. 250.*  
Wilkinson Plow Co. Ltd., Toronto, Ont.  
Bell, B. & Son, St. George, Ont.

**2668—PULVERIZERS—Mining, Stone.**

Stephenson, E. F. & Co., St. John, N.B. *Advt. 249.*  
Fraser, Bros., New Glasgow, N.S. *Advt. page 252.*

**2669—PULVERIZERS—Black Lead, Foundry  
Facing, Plumbago, Spice, Sugar.**

Stephenson, E. S. & Co., St. John, N. B. *Advt. p. 249.*

**2670—PULVERIZERS—(Land), Rotary Disk.**

Waterloo Mfg Co. Ltd., Waterloo, Ont. *Advt. p. 218.*  
Bissett, T. E., Prescott, Ont.  
Grout, John H. & Co., Grimby, Ont.  
Wortman & Ward Mfg Co., London, Ont.

**2671—PUMPS—Hydraulic, Duplex Fly Wheel**

Bertram, John & Sons, Dundas, Ont. *Advt. p. 161.*  
Ontario Engine & Machine Co. Ltd., Toronto, Ont.  
*Advt. page 177.*  
Northey Mfg Co. Ltd., Toronto, Ont.  
Carrier, Laine & Co., Levis, Que. *Advt. page 150.*  
Garth & Co., Montreal, Que. *Advt. page 154.*

**2672—PUMPS—Duplex Fly Wheel. See No. 2671.**

**2673—PUMPS—Boiler Feed.**

Ingersoll Rock Drill Co., Montreal, Que. *Advt. p. 198.*  
Fleck, Alex. Jr., Ottawa, Ont. *Advt. page 252.*  
Drolet, F. X., Quebec, Que.  
McAvity, T. & Sons, St. John, N. B. *Advt. page 153.*  
Carrier, Laine & Co., Levis, Que. *Advt. page 150.*  
Jenckes Machine Co., Sherbrooke, Que. *Advt. p. 165.*  
Brush, Geo., Montreal, Que.  
Burrell-Johnson Iron Co., Yarmouth, N. S.  
Goldie & McCulloch Co. Ltd., Galt, Ont. *Advt. p. 159.*  
Ontario Engine & Machine Co. Ltd., Toronto, Ont.  
*Advt. page 177.*  
Macdonald & Co. Ltd., Halifax, N. S. *Advt. p. 256.*  
Nie & Whitfield, Hamilton, Ont.  
Young Bros., Almonte, Ont. *Advt. page 250.*  
Leonard, E. & Sons, London, Ont.  
Robb Engineering Co. Ltd., Amherst, N. S.  
*See inside front cover.*

**2674—PUMPS—(Iron & Wood), Anti-Freezing,  
Artesian Well, Deep Well, Drive  
Well, Garden, Green-House, Lawn, Or-  
chard, Spray, Windmill.**

McDougall, R. & Co., Galt, Ont. *Advt. page 199.*  
Laing, Ritchie & Co., Essex, Ont. *Advt. page 209.*  
Young Bros., Almonte, Ont. *Advt. page 250.*  
Ontario Wind Engine & Pump Co. Ltd., Toronto,  
Ont. *Advt. page 244.*  
Wortman & Ward Mfg Co., London, Ont.  
McQuat & McRae, Lachute, Que. *Advt. page 205.*  
Plews, D. & Co., Toronto, Ont.  
Garth & Co., Montreal, Que. *Advt. page 154.*  
Goold, Shapley & Muir Co. Ltd., Brantford, Ont.  
*Advt. page 191.*

**2675—PUMPS—Combined Air & Condensers,  
Combined Air & Boiler Feed.**

Carrier, Laine & Co., Levis, Que. *Advt. page 150.*  
Goldie & McCulloch Co. Ltd., Galt, Ont. *Advt. 159.*  
Ingersoll Rock Drill Co., Montreal, Que. *Advt. 198.*  
Ontario Engine & Machine Co. Ltd., Toronto, Ont.  
*Advt. page 177.*  
Northey Mfg Co. Ltd., Toronto, Ont.

**2676—PUMPS—Bicycle.**

Goold Bicycle Co., Brantford, Ont. *Advt. page 220.*

**2677—PUMPS—Locomotive.**

Canadian Locomotive Engine Co. Ltd., Kingston,  
Ont. *Advt. page 175.*

**2678—PUMPS—Tank "Threshers", Knapsack  
Spray.**

Laing, Ritchie & Co., Essex, Ont. *Advt. page 209.*

**2679—PUMPS—Injection, Nickle Lined.**

Malcolm, W. B., Toronto, Ont.

**2680—PUMPS—Soap.**

Myers, W. F. & J. W., St. John, N.B. *Advt. p. 163.*

**2681—PUMPS—Low Pressure.**

McDougall, R. & Co., Galt, Ont. *Advt. page 199.*  
Carrier, Laine & Co., Levis, Que. *Advt. page 150.*  
Ontario Engine & Machine Co. Ltd., Toronto, Ont.  
*Advt. page 177.*  
Northey Mfg Co. Ltd., Toronto, Ont.

**2682—PUMPS—Elevator.**

Kerr & Morgan, Montreal, Que. *Advt. page 220.*  
Miller Bros. & Toms, Montreal, Que. *Advt. p. 197.*

**2683—PUMPS—Hand, Oil, Special, Sand.**

McDougall, R. & Co., Galt, Ont. *Advt. page 199.*  
Macdonald & Co. Ltd., Halifax, N.S. *Advt. p. 256.*  
Kerr Engine Co. Ltd., Walkerville, Ont. *Advt. 208.*  
Ingersoll Rock Drill Co., Montreal, Que. *Advt. 198.*

**2684—PUMPS—Milk.**

Richardson & Webster, St. Mary's, Ont.

**2685—PUMPS—Cheese Factory, Siphon,  
Whey.**

Pemberthy Injector Co., Windsor, Ont. *Advt. p. 164.*

**2686—PUMPS—Air Lift, Pneumatic.**

Canadian Rand Drill Co., Sherbrooke, Que. *Advt. 165.*

**2687—PUMPS—Breast, Rubber, See No. 2869.**

**2688—PUMPS—Rotary, Crank.**

Myers, W. F. & J. W., St. John, N. B. *Advt. page 163.*  
 Carrier, Laine & Co., Levis, Que. *Advt. page 150.*  
 Ingersoll Rock Drill Co., Montreal, Que. *Advt. p. 198.*  
 Ontario Engine & Machine Co., Toronto, Ont.  
*Advt. page 177.*  
 Robb Engineering Co. Ltd., Amherst, N. S.  
*See inside front cover.*

**2689—PUMPS—Air, Duplex Air.**

Laurie Engine Co., Montreal, Que. *Advt. page 179.*  
 Gardner, Robt & Son, Montreal, Que.  
 McDougall, R. & Co., Galt, Ont. *Advt. page 199.*  
 Carrier, Laine & Co., Levis, Que. *Advt. page 150.*  
 Ingersoll Rock Drill Co., Montreal, Que. *Advt. p. 198.*  
 Macdonald & Co. Ltd., Halifax, N. S. *Advt. p. 256.*  
 Northey Mfg Co. Ltd., Toronto, Ont.  
 Nie & Whitfield, Hamilton, Ont.  
 Robb Engineering Co. Ltd., Amherst, N. S.  
*See inside front cover.*

**2690—PUMPS—(Iron) Cistern, Hand, Pitcher.**

Ives, H. R. & Co., Montreal, Que. *Advt. page 200.*  
 Myers, W. F. & J. W., St. John, N. B. *Advt. p. 163.*  
 McDougall, R. & Co., Galt, Ont. *Advt. page 199.*  
 Bessette, J. & S., Iberville, Que.  
 Laing, Ritchie & Co., Essex, Ont. *Advt. page 209.*  
 Smart (James) Mfg Co., Brockville, Ont. *Advt. p. 178.*  
 McOuat & McRae, Lachute, Que. *Advt. page 205.*  
 Carrier, Laine & Co., Levis, Que. *Advt. page 150.*

**2691—PUMPS — (Brass) Beer & Ale, Force, Feed, Brewery, Cylinder, Oil, Distillery, Plumbers' Force, Vinegar, Hand.**

Mitchell, Robert & Co., Montreal, Que. *Advt. p. 213.*  
 Garth & Co., Montreal, Que. *Advt. page 154.*  
 Morrison, (Jas.), Brass Mfg Co. Toronto, *Advt. p. 157.*  
 Hamilton Brass Mfg Co., Hamilton, Ont. *Advt. p. 168.*  
 McAvity, T. & Sons, St. John, N. B. *Advt. page 153.*  
 Parker, J. O., Toronto, Ont. *Advt. page 253.*  
 Kerr Engine Co. Ltd., Walkerville, Ont. *Advt. p. 208.*  
 Ontario Engine & Machine Co. Ltd., Toronto, Ont.  
*Advt. page 177.*  
 Beatty, M. & Sons, Welland, Ont. *Advt. page 173.*  
 Carrier, Laine & Co., Levis, Que. *Advt. page 150.*  
 Booth Copper Co., Toronto, Ont. *Advt. page 135.*

**2692—PUMPS — (Iron) Cylinder, Drainage, Marine, Mining, Quarry, Sewerage, Wrecking, Ships.****2693—PUMPS — (Iron) Centrifugal, Compound, Duplex, Fire-Force, Paper Mill, Pulp Mill, Steam-Force, Tannery.**

Ontario Engine & Machine Works Co. Ltd., Toronto, Ont. *Advt. page 177.*  
 Burrell-Johnson Iron Co., Yarmouth, N.S.  
 Kerr & Morgan, Montreal, Que. *Advt. page 220.*  
 Myers, W. F. & J. W., St. John, N.B. *Advt. p. 163.*  
 Carrier, Laine & Co., Levis, Que. *Advt. page 150.*  
 Miller, Bros. & Toms, Montreal, Que. *Advt. p. 197.*  
 Garth & Co., Montreal, Que. *Advt. page 154.*  
 Goldie & McCulloch Co., Galt, Ont. *Advt. p. 159.*  
 Drolet, F. X., Quebec, Que.  
 Laurie Engine Co., Montreal, Que. *Advt. page 179.*  
 Ingersoll Rock Drill Co., Montreal, Que. *Advt. 198.*  
 Beatty, M. & Sons, Welland, Ont. *Advt. page 173.*  
 McDougall, R. & Co., Galt, Ont. *Advt. page 199.*  
 McOuat & McRae, Lachute, Que. *Advt. page 205.*

Kerr Engine Co. Ltd., Walkerville, Ont. *Advt. 208.*  
 Northey Mfg Co. Ltd., Toronto, Ont.  
 Robb Engineering Co. Ltd., Amhest, N.S.

*See inside front cover.*  
 Three Rivers Iron Works, Three Rivers, Que.  
*Advt. page 179.*  
 Macdonald & Co., Ltd., Halifax, N.S. *Advt. p. 256.*

**2694—PUMPS—Cornish, (Boiler) & Heater Compound.**

Gardner, Robt. & Son, Montreal, Que.

**2695—PUNCHES—Hand Power Lever, Hollow, Sheet Metal, Solid.**

Brown, Boggs & Co., Hamilton, Ont. *Advt. page 193.*

**2696—PUNCHES—Saw.**

Ballantine, John & Co., Preston, Ont. *Advt. page 205.*

**2697—PUNCHES—Bell, Blacksmiths', Center, Hand, Pin, Prick.**

Jardine, A. B. & Co. Hespeler, Ont. *Advt. page 217.*  
 Butterfield & Co., Rock Island, Que.  
 Whitman & Barnes Mfg Co., St. Catharines, Ont.

**2698—PUNCHES & SHEARS—Boiler Plate, Hydraulic, Power.**

Bertram, John & Sons, Dundas, Ont. *Advt. page 161.*  
 Goldie & McCulloch Co. Ltd., Galt, Ont. *Advt. p. 159.*

**2699—PUNCHES & SHEARS—Hand.**

Jardine, A. B. & Co., Hespeler, Ont. *Advt. page 217.*  
 Bertram, John & Sons, Dundas, Ont. *Advt. page 161.*

**2700—PURGER—Boiler (Cedar Extract)**

Rathbun Co. (The), Deseronto, Ont. *Advt. page 162.*

**2701—PURGER—Boiler.**

Young & Bro. Co. Ltd., Hamilton, Ont. *Advt. p. 257.*  
 Rathbun (The) Co., Deseronto, Ont. *Advt. page 162.*

**2702—PURIFIERS—Feed Water.**

Mitchell, Robert & Co., Montreal, Que. *Advt. p. 213.*

**2703—PURIFIERS — Corn Meal, Middling, Purifiers & Graders, (Reel).**

Goldie & McCulloch Co. Ltd., Galt, Ont. *Advt. 159.*

**2704—PURIFIERS—Live Steam.**

Robb Engineering Co. Ltd., Amherst, N.S.  
*See inside front cover.*

**2705—PURSES & POCKET BOOKS—Money.**

Brown Bros., Ltd. (The), Toronto, Ont.

**2706—PUTTY—Stove.**

Gurney, Tilden Co. Ltd., Hamilton, Ont. *Advt. 151.*

**2707—PUTTY—Glaziers', Painters'.**

Canada Paint Co., Montreal, Que. *Advt. page 221.*  
 Ramsay, A. & Son, Montreal, Que. *Advt. p. 211.*  
 Dominion Oil Cloth Co., Montreal, Que. *Advt. 201.*  
 Howe, William, Ottawa, Ont. *Advt. page 201.*  
 McArthur, Corneille & Co., Montreal, Que. *Advt. 221.*  
 Montreal Rolling Mills Co., Montreal, Que. *Advt. 174.*  
 Ontario Lead & Barb Wire Co. Ltd., Toronto, Ont.  
*Advt. page 177.*  
 Robertson Co. (Jas.), Toronto, Ont. *Advt. page 167.*

**2708—QUILLS—Cotton Mill.**

Hambleton & Co., Hampton, N. B.

**2709—QUININE.**

Lyman Sons & Co., Montreal, Que.

**2710—QUOITS—Pitching.**

Ives, H. R. & Co., Montreal, Que. *Advt. page 200.*  
 Smart, (Jas.) Mfg Co., Brockville, Ont. *Advt. p. 178.*  
 Macdonald & Co. Ltd., Halifax, N. S. *Advt. p. 256.*

**2711—RACKS—Hay & Stock (Wood).**

Chatham Mfg Co. Ltd., Chatham, Ont. *Advt. p. 245.*  
 Bain Bros. Mfg Co. Ltd., Brantford, Ont. *Advt. p. 249.*

**2712—RACKS—Hanging.**

Macdonald, J. K., Montreal, Que. *Advt. page 247.*

**2713—RACKS—Broom, Pen, Whip.**

Smart, (Jas.), Mfg Co., Brockville, Ont. *Advt. p. 178.*

**2714—RACKS—Wire Toast.**

Davidson Mfg Co. (Thos.), Montreal, Que. *Advt. 225.*

**2715—RACKS—Hose.**

Gutta Percha & Rubber Mfg Co. Ltd., Toronto, Ont.  
*See back cover.*

**2716—RACKS—Church Pew Book (Metal), Metal Towel.**

Garth & Co., Montreal, Que. *Advt. page 154.*  
 Ives, H. R. & Co., Montreal, Que. *Advt. page 200.*  
 Smart, (Jas.) Mfg Co., Brockville, Ont. *Advt. p. 178.*  
 Paris Electo Plating Co., Paris Station, Ont.

**2717—RACKS—Church Pew Book (Wood).**

*See No. 2960.*

**2718—RACKS—Printers' Galley.**

Chadwick Bros., Hamilton, Ont. *Advt. page 206.*  
 Westman & Baker, Toronto, Ont.

**2719—RACKS—Hall (Hat & Coat) Wood.**

Canadian Office & School Furniture Co. Ltd. (The),  
 Preston, Ont. *Advt. page 210.*  
 Gibbard Furniture Co. Ltd., Napanee, Ont.  
 Rogers, Charles & Sons' Co. Ltd., Toronto, Ont.  
 Hibner, B. & Co., Berlin, Ont.

**2720—RACKS—Iron Hay (Stable) Circle & Corner.**

*See No. 1831.*

**2721—RACKS—Hall & Hat (Bamboo).**

*See No. 3239.*

**2722—RADIATORS—(Cast Iron) Hot Water, Steam, Vertical Tube, Hotel, Office, Public Building.**

Toronto Radiator Mfg Co., Toronto, Ont. *Advt. 152.*  
 McLaren, H. & Co., Montreal, Que. *Advt. page 266.*  
 Gurney Foundry Co. Ltd., Toronto, Ont.  
 Garth & Co., Montreal, Que. *Advt. page 154.*

**2723—RADIATORS—(Safford) Artistic, Circle, Half Circle.**

Toronto Radiator Co., Toronto, Ont. *Advt. p. 152.*

**2724—RADISH—Horse.**

Lytle, T. A. & Co., Toronto, Ont.

**2725—RAILINGS—(Wire) Bank & Office.**

Meadows, George B., Toronto, Ont.  
 Dennis Wire & Iron Works, London, Ont. *Advt. 207.*  
 Greening Wire Co. Ltd. (B.), Hamilton, Ont.  
 Major Mfg Co., Montreal, Que.

**2726—RAILINGS — (Brass) Alter, Bank & Office, Counter, Desk, Hand.**

Mitchell, Robert & Co., Montreal, Que. *Advt. 213.*  
 Garth & Co., Montreal, Que. *Advt. page 154.*  
 Morrison James Brass Mfg Co., Toronto, Ont.  
*Advt. page 157.*

Hamilton Brass Mfg Co., Hamilton, Ont. *Advt. 168.*  
 McAvity, T. & Sons, St. John, N.B. *Advt. page 153.*  
 American Copper Co. (The), Toronto, Ont. *Advt. 157.*  
 Dennis Wire & Iron Works, London, Ont. *Advt. 207.*  
 Parke, J. O. & Co., Toronto, Ont.

**2727—RAILINGS—(Iron) Balcony, Bank & Office, Cemetery, Vault.**

Dennis Wire & Iron Works, London, Ont. *Advt. 207.*  
 Rodden, Wm. & Co., Montreal, Que.  
 Toronto Fence & Iron Works, Toronto, Ont.  
 Starr Mfg Co. Ltd., Halifax, N.S. *Advt. page 199.*  
 Dominion Ornamental Iron Co., Montreal, Que.  
 Garth & Co., Montreal, Que. *Advt. page 154.*  
 Ives, H. R. & Co., Montreal, Que. *Advt. page 200.*

**2728—RAILINGS — (Wood) Alter, Balcony, (Finnlals), Office.**

Rhodes, Curry & Co., Amherst, N. S. *Advt. p. 158.*  
 Rathbun (The) Co., Deseronto, Ont. *Advt. page 162.*  
 Edwards, W. C. & Co. Ltd., Ottawa, Ont. *Advt. 219.*  
 Gignac, O. & Fils., Quebec, Que.  
 Moffatt & Co., Carleton Place, Ont.  
 Thackray, Robert, Ottawa, Ont.  
 Dodd, John C. & Son, London, Ont.

**2729—RAILS — Guard, Door, Barn Door, Sliding-Door.**

Smart, (Jas.) Mfg Co., Brockville, Ont. *Advt. p. 178.*  
 Garth & Co., Montreal, Que. *Advt. page 154.*  
 McAvity, T. & Sons, St. John, N. B. *Advt. page 153.*  
 Ives, H. R. & Co., Montreal, Que. *Advt. page 200.*  
 Peterboro Lock Mfg Co., Peterboro, Ont. *Advt. p. 219.*

**2730—RAILS—Street Railway. See No. 2732.****2731—RAILS — Stove. See No 3316.****2732—RAILS—Mine, Railway.**

Portland Rolling Mills, St. John, N.B. *Advt. p. 195.*  
 Nova Scotia Steel Co. Ltd., New Glasgow, N. S.

**2733—RAILS—(Picket) Fence.**

Copping, William, Joliette, Que.

**2734—RAILS—Curved.**

Canada Spring & Switch Co., Montreal Que.  
*Advt. page 217.*

**2735—RAILS—Frog, Wing.**

Brown, (G & J.) Mfg Co., Belleville, Ont. *Advt. 198.*

**2736—RAILS—Shifting.**

Gillies Geo. Co., (The) Gananoque, Ont. *Advt. p. 156.*

**2737—RAILS—Door (Brass).**

McAvity, T. & Sons, St. John, N. B. *Advt. p. 153.*  
 Coulter & Campbell, Toronto, Ont. *Advt. page 201.*  
 Mitchell, Rob't & Co., Montreal, Que. *Advt. p. 213.*  
 Hamilton Brass Mfg Co., Hamilton, Ont. *Advt. p. 168.*

**2738—RAILS — (Dash) Carriage, Carriage Foot, Cutter.**

McKinnon Dash & Hardware Co., St. Catharines,  
 Ont. *Advt. page 202.*  
 Skinner & Co., Gananoque, Ont. *Advt. page 255.*



Frost, W. H., Smith's Falls, Ont.  
Walkerville Malleable Iron Co., Walkerville, Ont.

**2739—RAILWAYS—Cash & Parcel.**  
Kimball, S. S., Montreal, Que. *Advt. page 228.*

**2740—RAKES—Asphalt.**  
Nie & Whitfield, Hamilton, Ont.

**2741—RAKES—(Hand) Cast Iron, Malleable.**  
Welland Vale Mfg Co., St. Catharines, Ont.  
*Advt. page 241.*  
Burrow, Stewart & Milne Hamilton, Ont.

**2742—RAKES—(Wood) Drag, Garden, Hand.**  
Welland Vale Mfg Co., St. Catharines, Ont. *Advt. 241.*  
Whiting (A. S.) Mfg Co., Oshawa, Ont. *Advt. p. 241.*  
Rixford (O.S.) Mfg Co., Bedford, Que. *Advt. p. 241.*  
Bushlin, S., Port Elgin, Ont.

**2743—RAKES—Hay, "Ithaca", "Tiger".**  
Moody, Matthew & Sons, Terrebonne, Que. *Advt. 209.*  
Chalifoux, O. & Sons, St. Hyacinthe, Que. *Advt. 232.*

**2744—RAKES—(Hay) Sulky, Hand Dump, Foot Dump.**  
Hamilton Mfg Co. (Peter), Peterboro, Ont.  
*Advt. page 209.*  
Moody, Matthew & Sons, Terrebonne, Que. *Advt. 209.*  
Noxon Bros. Mfg Co., Ingersoll, Ont.  
Chalifoux, O. & Sons, St. Hyacinthe, Que. *Advt. 232.*  
Sleeper & Akhurst, Coaticook, Que. *Advt. page 241.*  
Joliette Foundry Co., Joliette, Que.  
Maxwell, David & Sons, St. Mary's, Ont. *Advt. 250.*  
McKinnon & McLean, Charlottetown, P.E.I.

**2745—RAMS—Hydraulic.**  
Smart (Jas.) Mfg Co., Brockville, Ont. *Advt. p. 178.*  
Robb Engineering Co. Ltd., Amherst, N.S.  
*See inside front cover.*

**2746—RANGES—Gas.** *See No. 2747.*

**2747—RANGES—(Steel) Dining Car, Restaurant.**  
Gurney Foundry Co. Ltd., Toronto, Ont.  
Burns, John & Co. Montreal, Que.  
Prowse, George R., Montreal, Que.  
Butterworth & Co., Ottawa, Ont.  
Chapleau, G., Montreal, Que.

**2748—RANGES—Wrought Iron.**  
Clare Bros. & Co., Preston, Ont. *Advt. page 243.*  
Ives, H. R. & Co., Montreal, Que. *Advt. page 200.*

**2749—RANGES—(Cast Iron) Cooking, Hotel, Steamboat.**  
Gurney, Tilden Co. Ltd., Hamilton, Ont. *Advt. 151.*  
Carrier, Laine & Co., Levis, Que. *Advt. page 150.*  
Smart Mfg Co. (Jas.), Brockville, Ont. *Advt. p. 178.*  
Ives, H. R. & Co., Montreal, Que. *Advt. page 200.*  
Clare Bros. & Co., Preston, Ont. *Advt. page 243.*  
Fawcett, Charles, Sackville, N.B.  
Stewart Mfg Co. (Jas.), Woodstock, Ont.  
Burrow, Stewart & Milne, Hamilton, Ont.  
Enterprise Foundry Co., (The), Sackville, N.B.  
Bigley, R., Toronto, Ont. *Advt. page 242.*  
Crossman & Laws, Amherst, N.S. *Advt. page 226.*  
Prowse, George R., Montreal, Que.  
Butterworth & Co., Ottawa, Ont.  
Record Foundry & Machine Co., Moncton, N.B.

**2750—RASPS & FILES—Blacksmiths', Cabinetmakers', Horseshoers', Iron-workers', Plumbers', Shoemakers', Veterinarians', Woodworkers'.**  
Globe Fire Mfg Co., Port Hope, Ont. *Advt. page 218.*  
Beaver File Works Co., Levis, Que. *Advt. page 241.*  
Ostler, Frank, Hamilton, Ont.  
Toronto File Works Co. (The), Toronto, Ont.  
Beech File Works, Hamilton, Ont.  
Phoenix File Works, Cote St. Paul, Que. *Advt. p. 255.*

**2751—RATTLERS—Anti-Shaft.**  
McKinnon Dash & Hardware Co., St. Catharines, Ont. *Advt. page 202.*  
Gillies, Geo. Co., (The), Gananoque, Ont. *Advt. p. 156.*  
Woodyatt, A. R. & Co., Guelph, Ont. *Advt. page 207.*  
Toronto Rubber Co. Ltd., (The), Toronto, Ont.  
Dennis Wire & Iron Works, London, Ont. *Advt. 207.*  
Gutta Percha & Rubber Mfg Co. Ltd., Toronto, Ont.  
*See back cover.*

**2752—RAZORS.**  
Brimstin, James, Toronto, Ont.

**2753—REAMERS—Pipe.**  
Ives, H. R. & Co., Montreal, Que. *Advt. page 200.*  
Jardine, A. B. & Co., Hespeler, Ont. *Advt. p. 217.*  
Butterfield & Co., Rock Island, Que.

**2754—REAMERS—Adjustable, Bit Brace, Center, Expansion, Square, Taper Pin.**  
Jardine, A. B. & Co., Hespeler, Ont. *Advt. p. 217.*  
Butterfield & Co., Rock Island, Que.  
Stevens, Hamilton, & Co., Galt, Ont.  
Whitman & Barnes Mfg Co., St. Catharines, Ont.

**2755—REAMERS—Finishing, Fluted Chucking.** *See No. 2754.*

**2756—REAPERS—Victor.**  
Bell, B. & Son, St. George, Ont.

**2757—REAPERS—Grain.**  
Hamilton (Peter), Mfg Co., Peterboro, Ont. *Advt. 209.*  
Moody, Matthew & Sons, Terrebonne, Que. *Advt. 209.*  
Noxon Bros. Mfg Co., Ingersoll, Ont.  
Frost & Wood, Smith's Falls, Ont.  
Sylvester Bros., Mfg Co., Lindsay, Ont.  
Bell, B. & Son, St. George, Ont.  
Maxwell, David & Sons, St. Mary's, Ont. *Advt. 250.*

**2758—RECEIVERS—Telephone.**  
Ness, McLaren & Bate, Montreal, Que. *Advt. p. 240.*

**2759—RECEIVERS—Card (Plated).**  
Simpson, Hall, Miller & Co., Montreal, Que.  
*Advt. page 203.*  
Ontario Silver Co., Humbertstone, Ont.

**2760—REDUCERS—Cast Iron Pipe.**  
Young & Bro. Co. Ltd., Hamilton, Ont. *Advt. p. 257.*  
Three Rivers Iron Works, Three Rivers, Que.  
*Advt. page 179.*  
Drummond, McCall & Co., Montreal, Que. *Advt. 206.*  
St. Lawrence Foundry Co., Toronto, Ont.

**2761—REEDS—Organ.**  
Newell, Aug. & Co., Toronto, Ont.

**2762—REEDS—Loom.**  
McLaren Belting Co. (The J. C.), Montreal, Que.

**2763—REELS—Clothes Line.**

Woodyatt, A. R. & Co., Guelph, Ont. *Advt. p. 207.*

**2764—REELS—Fire Hose.**

Waterous Engine Works Co. Ltd., Brantford, Ont.  
Smith Bros., Toronto, Ont. *Advt. page 178.*  
Ronald, J. B., Brussels, Ont.

**2765—REELS — Centrifugal, Cylindrical, Round, Packers', Floor.**

Goldie & McCulloch Co., Galt, Ont. *Advt. page 159.*  
Greay, Wm. & J. G., Toronto, Ont.

**2766—REELS—Yarn.**

Karch, H. W., Hespeler, Ont.

**2767—REELS—Clothes, Revolving, Folding.**

• McLaughlin, J., Ottawa, Ont.  
Storey Washing Machine Co. Ltd., Ottawa, Ont.  
McLeod Bros., Truro, N. S.  
Workman & Ward Mfg Co., London, Ont.

**2768—REELS—Hose (Garden) Lawn.**

Wesley, F. J. & Co., Toronto Junction, Ont.  
London Foundry Co. Ltd., London, Ont.

**2769—REFLECTORS—Polished, Lamp, Chandelier, Gas Light.**

American Copper Co. (The), Toronto, Ont. *Advt. 157.*  
Chadwick Bros., Hamilton, Ont. *Advt. page 206.*  
Mitchell, Robert & Co., Montreal, Que. *Advt. p. 213.*  
Garth & Co., Montreal, Que. *Advt. page 154.*

**2770—REFRIGERATORS — Counter, Lager Beer, Table Top, " Brantford Hardwood ".**

Knowles, Ham & Nott Co. Ltd., Brantford, Ont.  
*Advt. page 220.*

**2771—REFRIGERATORS—Cold Water, Domestic, Filter, Showcase.**

Eureka Refrigerator Co., Toronto, Ont. *Advt. p. 204.*

**2772—REFRIGERATORS — Butchers', Grocers', Hotel, Household, Arctic.**

Eureka Refrigerator Co., Toronto, Ont. *Advt. p. 204.*  
Phillips T. & Co., Orillia, Ont. *Advt. page 259.*  
Reed, Geo. W., Montreal, Que. *Advt. page 237.*  
Prowse, Geo. R., Montreal, Que.  
Gignac, O. & Fils, Quebec, Que.  
Knowles, Ham & Nott Co., Brantford, Ont. *Advt. 220.*  
McKelvey & Birch, Kingston, Ont. *Advt. page 228.*

**2773—REGISTERS—Smoke Pipe.**

Ives, H. R. & Co., Montreal, Que. *Advt. page 200.*

**2774—REGISTERS—Cash (McEwan).**

Globe Furniture Co., Walkerville, Ont. *Advt. p. 225.*

**2775—REGISTERS—Lumber Measuring.**

MacGregor, Gourlay & Co., Galt, Ont.

**2776—REGISTERS—Hotel Guest.**

Davis & Henderson, Toronto, Ont.  
Allen, T. C. & Co., Halifax, N. S.

**2777—REGISTERS—Telegraph.**

Ness, McLaren & Bate, Montreal, Que. *Advt. p. 240.*

**2778—REGISTERS—Cold & Hot Air, (Floor & Wall) Ventilating.**

Clare Bros. & Co., Preston, Ont. *Advt. page 243.*  
Gurney Foundry Co. Ltd., Toronto, Ont.  
Gurney, Tilden Co., Hamilton, Ont. *Advt. page 151.*  
Ives, H. R. & Co., Montreal, Que. *Advt. page 200.*  
Raymond, Chas., Guelph, Ont.  
Smart, (Jas.) Mfg Co., Brockville, Ont. *Advt. p. 178.*  
Burrow, Stewart & Milne, Hamilton, Ont.  
Robb Engineering Co. Ltd., Amherst, N. S.  
*See inside front cover.*

**2779—REGULATORS — (Pressure) Water, Steam, Beer, Gas.**

McAvery, T. & Sons, St John, N. B. *Advt. page 153.*  
Garth & Co., Montreal, Que. *Advt. page 154.*  
Morrison, Jas. Brass Mfg Co., Toronto. *Advt. p. 157.*

**2780—REGULATORS—Steam Boiler.**

Waring, White & Co., St. John, N.B. *Advt. p. 256.*

**2781—REGULATORS—Wind Mill.**

Goold, Shapley & Muir, Brantford, Ont. *Advt. 191.*  
Wortman & Ward Mfg Co., London, Ont.  
Plews, D. & Co., Toronto, Ont.

**2782—REGULATORS—Tread Power Speed.**

Moody, Matthew & Sons, Terrebonne, Que. *Advt. 209.*

**2783—REGULATORS — Damper (Electric Pressure).**

Newell, Aug. & Co. Toronto, Ont.

**2784—REGULATORS—Damper, Heat.**

Toronto Radiator Mfg Co., Toronto, Ont. *Advt. 152.*  
Robb Engineering Co. Ltd., Amherst, N.S.  
*See inside front cover.*

**2785—RELAYS—Telegraph.**

Ness, McLaren & Bate, Montreal, Que. *Advt. p. 240.*  
Toronto Electrical Works, Toronto, Ont.

**2786—REPAIRS—Ships, Vessels, Steamboat,**

Rathbun Co. (The), Deseronto, Ont. *Advt. p. 162.*  
Carrier, Laine & Co., Levis, Que. *Advt. page 150.*  
Matton, J. T., Sorel, Que.  
Bertram Engine Works Co. Ltd., Toronto, Ont.  
Davis, R. & Son, Kingston, Ont.  
Davie, George T., Levis, Que.  
Burrell, Johnson & Co., Yarmouth, N.S.  
Tate, W. & G. H., Montreal, Que.

**2787—RESTS—Stove Foot, *See No. 3316.*****2788—RESTS—Prop, Carriage.**

McKinnon Dash & Hardware Co., St. Catherines, Ont. *Advt. page 202.*  
Gillies, George Co. (The), Gananoque, Ont. *Advt. 156.*

**2789—RETORTS—Gas.**

Coulter & Campbell, Toronto, Ont. *Advt. page 201.*

**2790—RETORTS — Cast Iron, Processing, Canvassing, Amalgam, Retorts & Condensers.**

Fleck, Alex., Jr., Ottawa, Ont. *Advt. page 252.*  
Carrier, Laine & Co., Levis, Que. *Advt. page 150.*  
Parker, Moses, Montreal, Que. *Advt. page 197.*  
Matheson, I. & Co., New Glasgow, N.S. *Advt. 200.*

**2791—RIBBONS—Typewriter.**

Underwood, John & Co., Toronto, Ont.

**2792—RIGGINS—Wire Rope.** See No. 2793.

**2793—RIGS—Wire Rope Tramway Dumping.**  
Dominion Wire Rope Co., Montreal, Que. *Advt. p. 171.*

**2794—RIGS—(Saw), Circular, Drag.**  
See No. 2075.

**2795—RIMMERS—Pump.**  
Gardner Tool Co. (W. R.), Brockville, Ont.

**2796—RIMS—Bicycle, (Wood).**  
Cycle (Wood) Rim Mfg Co. (The), Toronto, Ont.

**2797—RINGERS—Hog.**  
Smart, (Jas.) Mfg Co., Brockville, Ont. *Advt. p. 178.*  
Woodyatt, A. R. & Co., Guelph, Ont. *Advt. p. 207.*

**2798—RINGS—(Rubber), Fruit Jar, Umbrella.**  
Canadian Rubber Co., Montreal, Que. *Advt. p. 197.*  
Gutta Percha & Rubber Mfg Co. Ltd., Toronto, Ont.  
See back cover.  
Alpha Rubber Co. Ltd., Montreal, Que.

**2799—RINGS—Rubber Teething.** See No. 2869.

**2800—RINGS—Wood.** See No. 3591.

**2801—RING—Clinch.**  
Swansea Forging Co. Ltd., Swansea, Ont. *Advt. 156.*

**2802—RINGS—(Harness), Halter, Hame, Martingale.**  
Skinner & Co., Gananoque, Ont. *Advt. page 255.*  
Kyle, P., Merrickville, Ont.  
Martin Mfg Co., Whitby, Ont.

**2803—RINGS—Key.**  
Peterboro Lock Mfg Co., Peterboro, Ont. *Advt. 219.*

**2804—RINGS—Curtain Pole, (Brass & Nickle)**  
Hamilton Brass Mfg Co., Hamilton, Ont. *Advt. 168.*  
Morrison, Jas. Brass Mfg Co., Toronto, Ont. *Advt. 157.*

**2804 a—RINGS—Fibrous.**  
Ashley Carriage Works, Belleville, Ont. *Advt. p. 204.*

**2805—RINGS—Diamond, Ear, Gold, Scarf, Wedding,**  
Dominion Rolled Plate Co., Montreal, Que. *Advt. 236.*  
Saunders, H. & A., Toronto, Ont.  
Dewdney, A. H. & Bro., Toronto, Ont.  
Ellis, P. W. & Co., Toronto, Ont.

**2806—RINGS—(Iron Bull), Clevis, Hitching, Hog, Plate, Post, Tie Plate, Trap Door.**  
Smart, (Jas.) Mfg Co., Brockville, Ont. *Advt. p. 178.*  
Woodyatt, A. R. & Co., Guelph, Ont. *Advt. p. 207.*  
Tisdale Iron Stable Fitting Co. Ltd. (The), Toronto, Ont. *Advt. page 202.*  
Dennis Wire & Iron Works, London, Ont. *Advt. 207.*  
Ives, H. R. & Co., Montreal, Que. *Advt. page 200.*  
Garth & Co., Montreal, Que. *Advt. page 154.*

**2807—RIVETS—Bronze, Steel Norway.**  
Canada Screw Co., Hamilton, Ont. *Advt. page 226.*

**2808—RIVETS—Carriage Top.**  
McKinnon Dash & Hardware Co. St. Catharines, Ont. *Advt. page 202.*

**2809—RIVETS—Joint.**  
Gillies, Geo. (The), Co., Gananoque, Ont. *Advt. p. 156.*

**2810—RIVETS—Shoe, (Brass), Copper, Iron, Tinned, Wire.**  
Parmenter & Bullock, Gananoque, Ont. *Advt. p. 199.*  
Gordon, J. J., St. John, N.B. *Advt. page 213.*  
Pender, James & Co. Ltd., St. John, N.B. *Advt. 208.*  
Canada Screw Co., Hamilton, Ont. *Advt. page 226.*  
Ontario Tack Co. (The), Hamilton, Ont. *Advt. 180.*  
Swansea Forging Co. Ltd., Swansea, Ont. *Advt. 156.*

**2811—RIVETS—Tubular, Wheel, Tank, Slotted, Smoke Stack, Shovel, Guard, Tinner's, Trunk, Shackle, Sleigh Shoe, Block Stove, Wagon.**  
Parmenter & Bullock, Gananoque, Ont. *Advt. p. 199.*  
Swansea Forging Co. Ltd., Swansea, Ont. *Advt. 156.*  
Canada Screw Co., Hamilton, Ont. *Advt. page 226.*

**2812—RIVETS—Steel.**  
Parmenter & Bullock, Gananoque, Ont. *Advt. p. 199.*  
Nova Scotia Steel Co. Ltd., New Glasgow, N.S.

**2813—RIVETS—Copper, Iron.** See No. 2811.

**2814—RIVETS—Boiler, Bridge.**  
Dominion Bridge Co. Ltd., Montreal, Que. *Advt. 195.*  
Starr Mfg Co. Ltd., Halifax, N.S. *Advt. page 199.*  
St. John, Bolt & Nut Co., St. John, N.B.  
Central Bridge & Engineering Co. Ltd., Peterboro, Ont. *Advt. page 214.*  
Swansea Forging Co. Ltd., Swansea, Ont. *Advt. 156.*

**2815—ROASTERS—Coffee.**  
Macdonald & Co. Ltd. Halifax, N.S. *Advt. page 256.*  
Cowan Co. Ltd. (The), Toronto, Ont.  
Brush, Geo., Montreal, Que.  
Gardner, Robert & Son, Montreal, Que.

**2816—ROBES—Baptismal.**  
Allen Mfg Co., Toronto, Ont.

**2817—ROBES—Burial.**  
Christie, Bros. & Co., Amherst, N.S. *Advt. page 232.*  
Thompson, D. W. & Co., Toronto, Ont.  
Globe Casket Co., London, Ont.  
Philp & Eckhart, Toronto, Ont.  
Simmens & Evel, Hamilton, Ont.

**2818—ROCKERS—Cobbler.**  
Krug, H., Berlin, Ont.

**2819—ROCKINGHAM WARE.**  
Brantford Stoneware Mfg Co. Ltd., Brantford, Ont. *Advt. page 251.*  
Farrar, E. L., Iberville, Que.  
Glass, Bros. & Co., London, Ont.

**2820—RODS—Connecting Piston.**  
Canadian Locomotive & Engine Co. Ltd., Kingston, Ont. *Advt. page 175.*  
Rathbun (The) Co., Deseronto, Ont. *Advt. page 162.*  
Carrier, Laine & Co., Levis, Que. *Advt. page 150.*

**2821—RODS—Nail.**  
Montreal Rolling Mills Co., Montreal, Que. *Advt. page 174.*  
Nova Scotia Steel Co. Ltd., New Glasgow, N. S.

**2822—RODS—Mitering.**  
Robertson, Jas. Co. Ltd., Toronto, Ont. *Advt. p. 167.*

**2823—RODS—(Fish) Cane, Salmon, Trout.**

Scribner, D. & Son, St. John, N. B.  
Dalzell, J., St. John, N. B.  
O'Shaughnessy, R. & Co., St. John, N. B.

**2824—RODS—(Wood) Dowel.** See No. 3591.**2825—RODS—Towel, Stove.**

Paris Electro Plating Co., Paris Station, Ont.

**2826—RODS—Pump.**

McDougall, R. & Co., Galt, Ont. *Advt. page 199.*

**2827—RODS—Iron, Stair, Stove, Window.**

See No. 3316.

Garth & Co., Montreal, Que. *Advt. page 154.*  
Canada Screw Co., Hamilton, Ont. *Advt. page 226.*  
Carrier, Laine & Co., Levis, Que. *Advt. page 150.*  
Gurney, Tilden Co. Ltd., Hamilton, Ont. *Advt. 151.*

**2828—RODS—Glass.**

Dominion Glass Works, Montreal, Que. *Advt. p. 221.*

**2829—RODS—(Brass) Stair, Picture.**

Garth & Co., Montreal, Que. *Advt. page 154.*  
Parker, J. O., Toronto, Ont. *Advt. page 253.*  
Hamilton Brass Mfg Co., Hamilton, Ont. *Advt. p. 168.*  
Mitchell, Robert & Co., Montreal, Que. *Advt. p. 213.*  
Essex Brass & Iron Co., London, Ont. *Advt. p. 257.*

**2830—RODS—Bridge Sway, Bridge, Building, Roof, Truss.**

Swansea Forging Co. Ltd., Swansea, Ont. *Advt. 156.*  
Stewart, John, New Glasgow, N. S. *Advt. page 222.*  
Carrier, Laine & Co., Levis, Que. *Advt. page 150.*  
Loignon, A. & E., Montreal, Que. *Advt. page 247.*  
Central Bridge & Engineering Co. Ltd., Peterboro, Ont. *Advt. page 214.*  
Dominion Bridge Co., Montreal, Que. *Advt. p. 195.*  
Brown, (G. & J.) Mfg Co., Belleville, Ont. *Advt. 198.*

**2831—ROLLERS—Packing House.**

Macdonald, J. K., Montreal, Que. *Advt. page 247.*

**2832—ROLLERS—(Spring), Blind & Shade, Self-acting.**

Wesley, F. J. & Co., Toronto Junction, Ont.  
McLeod Bros., Truro, N. S.  
Stewart, Hartshorn & Co., Toronto, Ont.  
Menzie, Turner & Co., Toronto, Ont.

**2833—ROLLERS—Gaff (Ship).**

Frizzell, Alexander, Halifax, N. S.

**2834—ROLLERS—Towel.** See No. 3591.**2835—ROLLERS—Rubber Hard, Wringer.**

Gutta Percha & Rubber Mfg Co. Ltd., Toronto, Ont.  
*See back cover.*  
Canadian Rubber Co., Montreal, Que. *Advt. p. 197.*

**2836—ROLLERS—Log.**

Lancaster Machine Works, Lancaster, Ont. *Advt. 248.*  
Hamilton Mfg Co. Ltd. (Wm.), Peterboro, Ont.

**2837—ROLLERS—(Square Pine) Blind.**

Hawkesbury Lumber Co. Ltd., Peterboro, Ont.  
Copping, Wm., Joliette, Que.

**2838—ROLLERS—Land (Scraper Attachment).**

Vessot, S. & Co., Joliette, Que. *Advt. page 238.*

**2839—ROLLERS—Barn Door, Hearse, Gate, Inclined-Plane, Sash, Shutter, Sliding Door, Trunk.**

Ives, H. R. & Co., Montreal, Que. *Advt. page 200.*  
Peterboro Lock Mfg Co., Peterboro, Ont. *Advt. 219.*  
Smart, (Jas.) Mfg Co., Brockville, Ont. *Advt. p. 178.*

**2840—ROLLERS—(Iron) Garden, Lawn.**

Hamilton Mfg Co. (Peter), Peterboro, Ont.  
*Advt. page 209.*

Coleman, T. T. (Estate of), Seaforth, Ont.  
Smart, (Jas.) Mfg Co., Brockville, Ont. *Advt. p. 178.*  
Gowdy Mfg Co., Guelph, Ont.  
Robb Engineering Co. Ltd., Amherst, N. S.

*See inside front cover.*

Walker Co'y. (The), Belleville, Ont.

**2841—ROLLERS—Land.**

Maxwell, David & Sons, St. Mary's, Ont. *Advt. 250.*  
Waterloo Mfg Co. Ltd., Waterloo, Ont. *Advt. p. 218.*  
Hamilton Mfg Co. (Peter), Peterboro, Ont.

*Advt. page 209.*

Moody, Matthew & Sons, Terrebonne, Que. *Advt. 209.*  
Lancaster Machine Works, Lancaster, Ont. *Advt. 248.*  
Vessot, S. & Co., Joliette, Que. *Advt. page 238.*  
Bell, B. & Son, St. George, Ont.  
Bessette, J. & S., Iberville, Que.  
Gowdey, Mfg Co., Guelph, Ont.  
New Hamburg Mfg Co., New Hamburg, Ont.

**2842—ROLLS—Cornish, Crushing.**

Jenckes Machine Co., Sherbrooke, Que. *Advt. p. 165.*

**2843—ROLLS—Sweat, Paper Mill.**

McQuat & McRae., Lachute, Que. *Advt. page 205.*

**2844—ROLLS—(Treeing) Grind Stone.**

Waring, White & Co., St. John, N. B. *Advt. p. 256.*

**2845—ROLLS—Flour Mill, Chilled Iron.**

Goldie & McCulloch Co. Ltd., Galt, Ont. *Advt. p. 159.*

**2846—ROLLS—Terra Cotta Hip.**

Rathbun Co. (The), Deseronto, Ont. *Advt. page 162.*

**2847—ROLLS—Jewelers', Machinists.**

Newell, Aug. & Co., Toronto, Ont.

**2848—ROLLS—Maple Mangle.**

Thompson, W. R., Teeswater, Ont. *Advt. page 233.*  
McLean & Son, Wingham, Ont.  
Button & Fessant, Wingham, Ont. *Advt. page 251.*  
Armstrong Bros., Markdale, Ont.  
Deutschman, Fred, Teeswater, Ont. *Advt. page 218.*

**2849—ROLLS—Dating, Embossing, Numbering.** See No. 3227.**2850—ROLLS—(Cloth), Bleachery.**

Hope, John, Lachute, Que. *Advt. page 188.*

**2851—ROLLS—Plate Bending, Rolling Mill.**

Bertram, John & Sons, Dundas, Ont. *Advt. p. 161.*  
Goldie & McCulloch Co. Ltd., Galt, Ont. *Advt. p. 159.*  
Carrier, Laine & Co., Levis, Quebec. *Advt. page 150.*  
Fraser Bros., New Glasgow, N. S. *Advt. page 252.*  
Matheson, I. & Co., New Glasgow, N.S. *Advt. p. 200.*

**2852—ROOFING—(Metallic), Car.** See No. 528.**2853—ROOFING—Actinolite.**

James, Joseph, Bridgewater, Ont.

**2854—ROOFING—Iron, Steel.** See No. 528.

**2855—ROOFING—Slate & Tile, Galvanized Iron.**

Reed, George W., Montreal, Que. *Advt. page 237.*  
Douglass Bros., Toronto, Ont. *Advt. page 204.*

**2856—ROOFING—(Steel), Corrugated, Elevator, Grain, Lightning Proof, Tinned Steel, "Thorn's Patent", "East Lake Pat, Shingle".**

Metallic Roofing Co. of Canada Ltd. (The), Toronto, Ont. *See front fly leaf.*

**2857—ROOFING—(Prepared) Asphalt, Cement, Felt, Fireproof, Pitch, Tarred.**

McArthur, Alex. & Co., Montreal, Que. *Advt. p 224.*  
Reed, George W., Montreal, Que. *Advt. page 237.*  
Paterson Mfg Co. Ltd. (The), Toronto, Ont.

**2858—ROOFS—Iron & Steel.**

Dominion Bridge Co. Ltd., Montreal, Que. *Advt. 195.*  
Loignon, A. & E., Montreal, Que. *Advt. page 247.*  
Stewart, John, New Glasgow, N.S. *Advt. page 222.*

**2859—ROOTS—Dried.**

Stearns, Fred. & Co., Windsor, Ont. *See back cover.*

**2860—ROPE—(Wire), Copper, Galvanized.**

*See No. 2862.*

**2861—ROPE—Bale, Bell, Braided, Cotton, Jute, Clothes Line, Skipping, Manilla & Sisal.**

Perine, M. B. & Co., Doon, Ont. *Advt. page 181.*  
Dovercourt Twine Mills Co., Toronto, Ont. *Advt. 184.*  
Canada Jute Co., Montreal, Que. *Advt. page 225.*

**2862—ROPE—(Wire) Ballasting, Elevator, Locomotive, Switch, Rigging, Tramway.**

Dominion Wire Rope Co., Montreal, Que. *Advt. 171.*

**2863—ROSETTES—Walnut & Turned.**

Goulette, O. V., Gananoque, Ont. *Advt. page 214.*

**2864—ROSETTES—Brass.**

**2865—ROSETTES—Iron.**

Carrier, Laine & Co., Levis, Que. *Advt. page 150.*  
Garth & Co., Montreal, Que. *Advt. page 154.*

**2866—ROSETTES—Metal.** See No. 528.

**2867—ROUGH STUFFS—(Paint).**

Canada Paint Co., Montreal, Que. *Advt. page 221.*  
McArthur, Corneille & Co., Montreal, Que. *Advt. 221.*  
Howe, Wm., Ottawa, Ont. *Advt. page 201.*  
Henderson & Potts, Halifax, N. S.  
Ramsay, A. & Son, Montreal, Que. *Advt. page 211.*

**2868—ROUNDS—Ladder.**

Edwards, W. C. & Co., Ottawa, Ont. *Advt. p. 219.*  
Parker & Howe, Dixville, Que.

**2869—RUBBER—(Druggists'), Soft Rubber Goods.**

Alpha Rubber Co. Ltd., Montreal, Que.

**2870—RUDDERS—Ships.**

Matheson, I. & Co., New Glasgow, N. S. *Advt. 200.*  
Nova Scotia Steel Co. Ltd., New Glasgow, N. S.

**2871—RUGS—(Skin) Animal, Mountain Goat, Reindeer.**

Bell & Co., Tilsonburg, Ont.  
Laliberte, J. B., Quebec, Que.  
Severeen, Jacob, Delhi, Ont.  
Stroh, J. G., Waterloo, Ont.

**2872—RUGS—Oil Cloth.**

Dominion Oil Cloth Co., Montreal, Que. *Advt. 201.*

**2873—RUGS—Oiled Lap.**

Soper, R., Hamilton, Ont. *Advt. page 229.*

**2874—RUGS—Sheep Skin, (Hearth).**

Pett, James, Hamilton, Ont.  
Camelford, John Jr. & Co., Paris, Ont.

**2875—RUGS—Axminster, Ingrain.**

Toronto Carpet Mfg Co., Toronto, Ont. *Advt. p. 186.*  
Campbell, A., Markham, Ont.

**2876—RUGS—Lap, Traveling, Smyrna, Venetian.**

Mitchell, Wm., Cobourg, Ont. *Advt. page 185.*  
Toronto Carpet Mfg Co., Toronto, Ont. *Advt. p. 186.*  
Paton Mfg Co., Sherbrooke, Que.  
Almonte Blanket Mills, Almonte, Ont.

**2877—RUGS—Carriage, Children's Carriage, Wool, Door, Floor.**

Mitchell, Wm., Cobourg, Ont. *Advt. page 185.*  
Toronto Carpet Mfg Co., Toronto, Ont. *Advt. p. 186.*  
Waterloo Woolen Co. Ltd., Waterloo, Ont.  
Hawthorne Woolen Co. Ltd., Carleton Place, Ont.  
Clarke, A. & J., Bullock's Corners, Ont.

**2878—RULES—Printers'.**

National Electro & Stereotype Co., Toronto, Ont.  
Dominion Type Foundry, Montreal, Que.

**2879—RULES—(Wood), Hickory, Log, Lumbermen's.**

Magee Mfg Co. Ltd., London, Ont.

**2880—RUNWAYS—Packing House.**

Macdonald, J. K., Montreal, Que. *Advt. page 247.*

**2881—RUNNERS—Children's Carriage.**

Gendron Mfg Co. Ltd., Toronto, Ont. *Advt. p. 187.*

**2882—SACKS—(Paper), Flour.**

Kilgour Bros., Toronto, Ont.  
Wilson, J. C. & Co., Montreal, Que.  
Lincoln Paper Mills Co. Ltd., Merritton, Ont.  
Taylor Bros., Toronto, Ont.

**2883—SACKS—Wool.**

Dick, Ridout & Co., Toronto, Ont.

**2884—SADDLES—Bicycle.**

Goold Bicycle Co. Ltd., Brantford, Ont. *Advt. p. 220.*  
Kingston Vehicle Co. Ltd., Kingston, Ont. *Advt. 202.*

**2885—SADDLES—Cart, Coupe, Cowboy, Gig, Track.** See No. 1669.

**2886—SAFES—Match (Iron) Toy.**

Davidson Mfg Co. (Thos.), Montreal, Que. *Advt. 225.*  
 Smart, (Jas.) Mfg Co., Brockville, Ont. *Advt. p. 178.*  
 Ives, H. R. & Co., Montreal, Que. *Advt. page 200.*

**2887—SAFES—Burglar Proof, Bank, Jewelers', Office, Fire Proof, Household, Silk Factory.**

Goldie & McCulloch Co. Ltd., Galt, Ont. *Advt. p. 159.*  
 Kimball, S. S., Montreal, Que. *Advt. page 228.*  
 Chapleau, G., Montreal, Que.

**2888—SAILS—Yacht & Vessel, Tent.**

Soper, R., Hamilton, Ont. *Advt. page 229.*  
 Montreal Tent, Awning & Tarpaulin Co., Montreal, Que. *Advt. page 232.*  
 Pike, D., Toronto, Ont. *Advt. page 182.*  
 Knapp, A. C., Kingston, Ont. *Advt. page 229.*  
 Kennedy, A. & Co., Charlottetown, P.E.I.  
 Playfair, James & Co., Collingwood, Ont.  
 Hewitt, Charles, Lunenburg, N.S.  
 Flowers, George & Son, Halifax, N.S.  
 Turner, J. J. & Son, Peterborough, Ont.  
 Blackhader, C. H. & Son, Halifax, N.S.  
 Cole's National Mfg Co., Ottawa, Ont.  
 Oldrieve & Horn, Kingston, Ont.  
 Sonne, Thomas, Montreal, Que.  
 Stone, James, Port Hope, Ont.  
 Blackiston, W. C., Quebec, Que.  
 Worth, John, Charlottetown, P.E.I.  
 Leckie, J. Toronto, Ont.  
 Jones, C. H., Vancouver, B.C.  
 Marvin, E. B. & Co., Victoria, B.C.

**2889—SALINE—Fruit.**

Dunn, W. G. & Co., Hamilton, Ont.

**2890—SALT—Cheese, Butter, Fine Family, Packers'.**

Windsor Salt Co., Windsor, Ont. *Advt. page 242.*  
 Coleman, T. T., (Estate of) Seaforth, Ont.

**2891—SALT—Fine (Windsor).**

Windsor Salt Co., Windsor, Ont. *Advt. page 242.*

**2892—SALT—Celery.**

Pure Gold Mfg Co., Toronto, Ont.

**2893—SALT—Coarse, Dairy, Land, Table.**

Windsor Salt Co., Windsor, Ont. *Advt. page 242.*  
 Coleman, T. T. (Estate of), Seaforth, Ont.  
 North American Chemical Co., Goderich, Ont.  
 Ogilvie & Hutchison, Goderich, Ont.  
 Ransford, R. & J., Clinton, Ont.  
 Ontario Peoples Salt & Soda Co., Kincardine, Ont.  
 Gray, Young & Sparling Co. Ltd., Seaforth, Ont.

**2894—SALTS—Tincture, Tartar, Glauber's, Copper, Iron, Tin, Lead, Zinc, Lisbium, Manganese.**

Canada Chemical Mfg Co. Ltd., London, Ont.  
 Lyman, Bros. & Co., Toronto, Ont.  
 Victoria Chemical Co. Ltd. (The), Victoria, B.C.

**2895—SALTS—Chemical.**

Canada Chemical Mfg Co. Ltd., London, Ont.  
 Lyman, Bros. & Co. Ltd., Toronto, Ont.  
 Evans and Sons, Ltd., Montreal, Que.

**2896—SALTS—Mineral Water.**

Parke, Davis & Co., Walkerville, Ont.

**2897—SALMON—Canned.**

Anglo—British Columbia Packing Co., Vancouver, B.C.  
 British Columbia Canning Co., Victoria, B.C.  
 Brunswick & Pacific Coast Canning Co., Vancouver.  
 Beaver Canning Co., New Westminster, B.C.  
 Cunningham, R. & Son, Nanaimo, B.C.  
 Canadian Pacific Packing Co., Vancouver, B.C.  
 Goodmurphy, Dinsmore & Co., New Westminster, B.C.  
 Spencer, S. A., Nanaimo, B.C.  
 Gulf of Georgia Canning Co., Ladners Landing, B.C.  
 Inverness Canning Co., Victoria, B.C.  
 Lowe Inlet Packing Co., Skeena, B.C.  
 Nass Industrial Store Co., Victoria, B.C.  
 Richmond Canning Co., New Westminster, B.C.  
 Royal Canadian Packing Co. Ltd., Victoria, B.C.  
 British Columbia Canning Co., Mission City, B.C.  
 Short & Squair, Ladners Landing, B.C.

**2898—SASH—Door & Blind, (Board Shutters) (Blackboards).**

Edwards, W. C. & Co., Ottawa, Ont. *Advt. p. 219.*  
 Rathbun Co. (The), Deseronto, Ont. *Advt. p. 162.*  
 Gravel Lumber Co. Ltd. (The A.), Etchemin, Que. *Advt. page 215.*  
 Rhodes, Curry & Co. Ltd., Amherst, N.S. *Advt. 158.*  
 Gignac, O. & Sons, Quebec, Que.  
 Paquet & Godbout, Montreal & St. Hyacinthe, Que.  
 Cargill, H. & Son, Cargill, Ont.  
 Schultz Bros., Brantford, Ont.  
 Gilmour & Co., Trenton, Ont.  
 Dodd, J. G., London, Ont.  
 Duchemin, A. & Co., Charlottetown, P.E.I.  
 Ross, L. A., Cornwall, Ont.  
 Robertson & Hackett, Vancouver, B.C.  
 Scott, Lawton & Sons, St. John, N.B.

**2899—SASHES—Wool.**

Lennard, S. & Sons, Dundas, Ont.  
 Universal Knitting Machine Co. Ltd., Toronto, Ont.

**2900—SATCHELS—Music. See No. 2267 a.****2901—SATCHELS—Leather, Letter, Medicine, School.**

Fournier & Boyer, Montreal, Que.  
 Cairnes & McBrine, Berlin, Ont.  
 Borbridge, S. & H., Ottawa, Ont.

**2902—SATINETTES—(Confectionery).**

McCormick Mfg Co., London, Ont.

**2903—SAUCE—Pepper, Table, Worcester-shire.**

Dunn, W. G. & Co., Hamilton, Ont.  
 Turner, Robert, Toronto, Ont.

**2904—SAWS—Butchers', Ship Carpenters', Mitre Box, Panel, Plumbers', Pruning, Scroll, Hand Rip, Compass, Hand, Box Board Cut Off.**

Shurly & Dietrich, Galt, Ont.  
 Smith, R. H. Co. Ltd., St. Catharines, Ont.  
 Burns Saw Co. (E. R.), Toronto, Ont.

**2905—SAWS—(Stone), Screw Gang.**

Beatty, M. & Sons, Welland, Ont. *Advt. page 173.*

**2906—SAWS—Steel RAIL.**

Beaver Saw Works Co., Hamilton, Ont.

**2907—SAWS—“ Spalding ” Tooth, “ Emerson ”, “ Lumber Clipper ”.**

Robertson Co. Ltd. (Jas.), Toronto, Ont. *Advt. p. 167.*  
do do do Montreal, Que. *Advt. 167.*  
do do do St. John, N.B. *Advt. p. 167.*  
do do do Winnipeg, Man. *Advt. 167.*

**2908—SAWS—Framed Buck.**

Smith, R. H. Co. Ltd., St. Catharines, Ont.  
Beaver Saw Works Co., Hamilton, Ont.  
Lawton Saw Co. Ltd., St. John, N.B.

**2909—SAWS—Cross Cut, Drag.**

Welland Vale Mfg Co., St. Catharines, Ont. *Advt. 241.*  
Bessette, J. & S., Iberville, Que.  
Brown (G. & J.), Mfg Co., Belleville, Ont. *Advt. 198.*  
Lawton Saw Co. Ltd., St. John, N.B.  
Burns Saw Co. (E. R.), Toronto, Ont.  
Wood, John, Montreal, Que.  
Robertson Co. Ltd. (Jas.), Montreal, Que., *Advt. 167.*  
do do do Toronto, Ont. *Advt. p. 167.*  
do do do St. John, N.B. *Advt. 167.*  
do do do Winnipeg, Man. *Advt. 167.*  
Pontbriand & Bros., Sorel, Que.

**2910—SAWS—Jig.**

Pontbriand & Bros., Sorel, Que.  
Thompson, Joseph, St. John, N.B.

**2911—SAWS—Pulp Mill, Veneering, Shingle, Gang, Swing Cut Off, Circular, Concave Circular, Grooving Circular, Segment, Bolting, Re-Sawing, Timber, One Man Cross Cut, Pit, Blind Slat.**

Robertson Co. Ltd. (Jas.), Toronto, Ont. *Advt. p. 167.*  
do do do Montreal, Que. *Advt. 167.*  
do do do St. John, N. B. *Advt. 167.*  
do do do Winnipeg, Man. *Advt. 167.*  
Pontbriand & Bros., Sorel, Que.  
Lawton Saw Co., St. John, N. B.  
Burns Saw Co. (E. R.), Toronto, Ont.  
Beaver Saw Works Co., Hamilton, Ont.

**2912—SAWS—Band.**

Robb Engineering Co. Ltd., Amherst, N. S.  
*See inside front cover.*  
Waterous Engine Works Co., Brantford, Ont.  
Robertson Co., Ltd. (Jas.), Toronto, Ont. *Advt. 167.*  
do do do St. John, N. B. *Advt. 167.*  
do do do Montreal, Que. *Advt. 167.*  
do do do Winnipeg, Man. *Advt. 167.*  
Pontbriand & Bros., Sorel, Que.

**2913—SAW GUMMERS.**

Canadian Locomotive & Engine Co., Kingston, Ont.  
*Advt. page 175.*  
Jardine, A. B. & Co., Hespeler, Ont. *Advt. page 217.*  
Robb Engineering Co. Ltd., Amherst, N. S.  
*See inside front cover.*  
Butterfield & Co., Rock Island, Que.

**2914—SAW GUMMERS—Emery Wheel.**

Prescott Emery Wheel Co., Prescott, Ont. *Advt. 237.*  
Hart Emery Wheel Co., Hamilton, Ont. *Advt. p. 166.*

**2915—SCALES—Automatic, Bag & Barrel, Gold.**

Gurney Scale Co., Hamilton, Ont. *Advt. page 244.*

**2916—SCALES—(Iron & Steel) Beam, Coal, Dairy, Farm, Family, Grain, Hay, Hopper, Market, Mill, Ore, Railway Track, Rolling Mill, Stock, Warehouse, Platform.**

Gurney Scale Co., Hamilton, Ont. *Advt. page 244.*

**2917—SCALES — (Brass) Butchers', Druggists', Counter, Grocers, Chemists, Scales & Balances.**

Gurney Scale Co., Hamilton, Ont. *Advt. page 244.*  
Pritchard & Andrews, Ottawa, Ont. *Advt. page 250.*  
Burrow, Stewart & Milne, Hamilton, Ont.

**2918—SCALPERS—Elevator. See No. 2920.**

**2919—SCALDERS—(Canners) Fruit & Vegetable, See No. 2125.**

**2920—SCOURERS — Corn, Wheat, Wool, “ Milling Separators ”.**

Goldie & McCulloch Co. J.td., Galt, Ont. *Advt. 159.*

**2921—SCOWS—River.**

Canada Marine Works, Montreal, Que.

**2922—SCOOPS—Glass.**

Dominion Glass Works, Montreal, Que. *Advt. p. 221*

**2923—SCOOPS — (Brass, Copper & Tin) Candy, Confectioners', Scale, Sugar, Tea, Tanners.**

American Copper Co., Toronto, Ont. *Advt. p. 157.*  
Chadwick Bros., Hamilton, Ont. *Advt. page 206.*  
Booth Copper Co., Toronto, Ont. *Advt. page 155.*  
Bateman, William & Co., Montreal, Que. *Advt. 247.*  
Coulter & Campbell, Toronto, Ont. *Advt. page 201.*

**2924—SCOOPS—Shovels and Spades, (Iron & Steel).**

Halifax Shovel Co., Halifax, N.S.  
Jones, D. F. Mfg Co. Ltd., Gananoque, Ont.  
Willett, S. T., Chambly Canton, P.Q.

**2925—SCOOPS—Vegetable, Root. See No. 1460.**

**2926—SCOOPS—Veneer.**

Cane & Sons Mfg Co. Ltd. (The Wm.), Newmarket, Ont. *Advt. page 218.*  
Smith & Henderson, Blenheim, Ont.

**2927—SCRAPERS—(Drag), Bowl, Contractors', Dump, Road, Steel, Wheeled.**

Brown (G. & J.) Mfg Co., Belleville, Ont. *Advt. 198.*  
Waterloo Mfg Co., Waterloo, Ont. *Advt. page 218.*  
Hamilton Peter Mfg Co., Peterboro, Ont. *Advt. 209.*  
Carrier, Laine & Co., Levis, Que. *Advt. page 150.*  
Bell, B. & Sons, St. George, Ont.  
Gowdy Mfg Co., Guelph, Ont.  
Wilkinson Plow Co. Ltd., Toronto Junction, Ont.  
Connell Bros., Woodstock, N.B.  
Dobbie & Stuart, Thorold, Ont.  
Coleman, T. T. (Estate of), Seaforth, Ont.

**2928—SCRAPERS—Stove.**

Gurney, Tilden Co., Hamilton, Ont. *Advt. page 151.*  
Paris Electro Plating Co., Paris Station, Ont.

**2929—SCRAPERS—Box, Coopers', Ship, Ship-Deck.**

Robertson Co. Ltd. (Jas.), Toronto, Ont. *Advt. p. 167.*  
Wornock, James & Co., Galt, Ont.  
Gardner Tool Co. (W. R.), Brockville, Ont.  
Broad, E & Sons Co., St. Stephen, N. B.

**2930—SCRAPERS—Foot, Door.**

Woodyatt, A. R. & Co., Guelph, Ont. *Advt. p. 207.*  
Smart, (Jas.) Mfg Co., Brockville, Ont. *Advt. p. 178.*  
Garth & Co., Montreal, Que. *Advt. page 154.*  
Ives, H. R. & Co., Montreal, Que. *Advt. page 200.*

**2931—SCREENS—(Iron) Clay, Masons, Ore, Pipe Coil, Steel, Coal, Gravel, Sand.**

Maconnald & Co. Ltd. Halifax, N.S. *Advt. page 256.*  
Garth & Co., Montreal, Que. *Advt. page 154.*  
Carrier, Laine & Co., Levis, Que. *Advt. page 150.*  
Fraser Bros., New Glasgow, N. S. *Advt. page 252.*  
Dennis Wire & Iron Works, London, Ont. *Advt. 207.*  
Ives, H. R. & Co., Montreal, Que. *Advt. page 200.*  
Meadows, Geo. B., Toronto, Ont.

**2932—SCREENS—(Brass) Dash, Fire, Folding.**

Hamilton Brass Mfg Co., Hamilton, Ont. *Advt. 168.*  
Dennis Wire & Iron Works, London, Ont. *Advt. 207.*  
Davidson Mfg Co. (Thos.), Montreal, Que. *Advt. 225.*  
Meadows, George, B., Toronto, Ont.  
Chadwick, Bros., Hamilton, Ont. *Advt. page 206.*

**2933—SCREENS—(Slat) Folding.**

Otterville Mfg Co. Ltd., Otterville, Ont. *Advt. p. 259.*

**2934—SCREENS—Wire,**

Meadows, Geo. B., Toronto, Ont.  
Greening Wire Co. Ltd. (The B.), Hamilton, Ont.  
Greening, T. & Sons, Chatham, Ont.  
Ulley, J. J. & Son., Montreal, Que.

**2935—SCREENS—Pulp & Paper Mill.**

Jenckes Machine Co., Sherbrooke, Que. *Advt. p. 165.*

**2936—SCREENS—Bamboo, Folding, Rattan, Reed.**

Gendron Mfg Co. Ltd., Toronto, Ont. *Advt. page 187.*  
American Rattan Co., Toronto, Ont.  
Thompson, Alex. & Co., Hamilton, Ont.

**2937—SCREENS—Thrashing Machine, Separator, Fanning Mill, Flour Mill, Grain Cleaning.**

Greening, T. & Sons, Chatham, Ont.  
Meadows, George B., Toronto, Ont.

**2938—SCREENS—(Framed) Door, Window.**

Edwards, W. C. & Co., Ottawa, Ont. *Advt. page 219.*  
Knowles, Ham & Nott Co. Ltd., Brantford, Ont.

*Advt. page 220.*  
Brockville Wringer Co. Ltd., Brockville, Ont.

Munro Bros., New Glasgow, N.S. *Advt. page 244.*  
Dennis Wire & Iron Works, London, Ont. *Advt. 207.*

Gignac, O. & Fils, Quebec, Que.  
Meadows, George B., Toronto, Ont.

Rathbun Co., (The), Deseronto, Ont. *Advt. page 162.*  
Rhodes, Curry & Co. Ltd., Amherst, N.S. *Advt. 158.*

**2939—SCREWS—(Jack) House Rasing, Locomotive, Track, Traversing.**

Canadian Locomotive & Engine Co., Kingston, Ont.  
*Advt. page 175.*

Bessette, J. & S., Iberville, Que.  
Laurie Engine Co., Montreal, Que. *Advt. page 179.*  
Loignon, A. & E., Montreal, Que. *Advt. page 247.*  
McOuat & McRae, Lachute, Que. *Advt. page 205.*  
Robb Engineering Co. Ltd., Amherst, N. S.

*See inside front cover.*

Carrier, Laine & Co., Levis, Que. *Advt. page 150.*

Bell, B. & Son, St. George, Ont.

Smart, (Jas.) Mfg Co., Brockville, Ont. *Advt. p. 178.*

**2940—SCREWS—(Wood) Bench, Hand, Carpenters Clamp.**

Smart, (Jas.) Mfg Co., Brockville, Ont. *Advt. p. 178.*

Still, J. H., St. Thomas, Ont.

Crawford, W. C., Tilbury Centre, Ont.

Strathroy Mfg Co. Ltd. (The), Strathroy, Ont.

**2941—SCREWS—(Iron) Cheese Press, Cider Press, Chilled, Iron Bench, Office Stool, Piano-Stool, Revolving Chair.**

Smart, (Jas.), Mfg Co., Brockville, Ont. *Advt. p. 178.*

Starr Mfg Co. Ltd., Halifax, N.S. *Advt. page 199.*

Morrow Machine Screw Co. (John.), Ingersoll, Ont.

*Advt. page 260.*

Canada Screw Co., Hamilton, Ont. *Advt. page 226.*

Ives, H. R. & Co., Montreal, Que. *Advt. page 200.*

Gillies, Geo. (The) Co., Gananoque, Ont. *Advt. p. 156.*

Joliette Foundry Co., Joliette, Que.

Gowdy Mfg Co., Guelph, Ont.

**2942—SCREWS—Bed, Cap, Bicycle, Milled Machine, Set, Special, Thumb.**

Swansea Forging Co. Ltd., Swansea, Ont. *Advt. 156.*

Morrow Machine Screw Co. (John), Ingersoll, Ont.

*Advt. page 260.*

Starr Mfg Co. Ltd., Halifax, N. S. *Advt. page 199.*

Canada Screw Co., Hamilton, Ont. *Advt. page 226.*

**2943—SCREWS—Harness Pad.**

Skinner & Co., Gananoque, Ont. *Advt. page 255.*

Burrow, Stewart & Milne, Hamilton, Ont.

**2944—SCREWS—Brass, Bronze, Dowel, Knob, Shear, Skate, Skein, Ornamental, Saw, Coach, Hand Rail.**

Canada Screw Co., Hamilton, Ont. *Advt. page 226.*

**2945—SCREW-DRIVERS.**

Cowan & Britton, Gananoque, Ont.

Whitman & Barnes Mfg Co., St. Catharines, Ont.

**2946—SCRIBBLERS—School.**

Gage, W. J. Co. Ltd., Toronto, Ont. *Advt. page 189.*

Brown Bros. Co. Ltd., Toronto, Ont.

Allen, T. C. & Co., Halifax, N.S.

Morton, Phillips & Co., Montreal, Que.

**2947—SCROLL WORK—(Wood) Scrolls.**

Acme Veneer Works, Orillia, Ont. *Advt. page 217.*

Rutherford, William & Sons, Montreal, Que.

Moffatt & Co., Carleton Place, Ont.

**2948—SCROLLS—Iron,**

Dennis Wire & Iron Works, London, Ont. *Advt. 207.*

Macdonald, J. K., Montreal, Que. *Advt. page 247.*

**2949—SCUFFLERS—Corn, Root.**

Maxwell, David & Sons, St. Mary's, Ont. *Advt. 250.*

Moody, Matthew & Sons, Terrebonne, Que. *Advt. 209.*

Coleman, T. T. (Estate of), Seaforth, Ont.



- Chalifoux, O. & Sons, St. Hyacinthe, Que. *Advt.* 232.  
 Bell, B. & Son, St. George, Ont.  
 New Hamburg Mfg Co., New Hamburg, Ont.
- 2950—SCYTHES—Bush, Grass, Grain, Turf Edgers, Hooks, Hay Knives.**  
 Welland Vale Mfg Co., St. Catharines, Ont. *Advt.* 241.  
 Whiting Mfg Co. (A. S.), Oshawa, Ont. *Advt.* p. 241.  
 Canada Axe & Harvest Tool Co., Cote St. Paul, Que. *Advt.* page 241.  
 Rixford Mfg Co. (O.S.), Upper Bedford, Que. *Advt.* page 241.
- 2951—SEALS — Corporation, Notarial, Society, Wax,** *See No.* 3227.
- 2952—SEATINGS—Veneer (Perforated).** *See No.* 3652.
- 2953—SEATS—Water Closet.**  
 Acme Veneer Works, Orillia, Ont. *Advt.* page 217.  
 McKelvie & Birch, Kingston, Ont. *Advt.* page 228.  
 Gignac, O. & Fils, Quebec, Que.  
 Thackray, Robert, Ottawa, Ont.  
 Goderich Organ Co., Goderich, Ont.
- 2954—SEATS—(Iron) Garden & Park Setees.**  
 Carrier, Laine & Co., Levis, Que. *Advt.* page 150.  
 Dennis Wire & Iron Works, London, Ont. *Advt.* 207.  
 Ives, H. R. & Co., Montreal, Que. *Advt.* page 200.  
 Garth & Co., Montreal, Que. *Advt.* page 154.
- 2955—SEATS—Cart, Wagon.**  
 Chatham Mfg Co. Ltd., Chatham, Ont. *Advt.* p. 245.  
 Smith Bros., Toronto, Ont. *Advt.* page 178.  
 Bain Bros. Mfg Co., Brantford, Ont. *Advt.* p. 249.  
 Speight Mfg. Co., Markham, Ont. *Advt.* page 245.
- 2956—SEATS—Patent Spring School, Wall Bracket.**  
 Globe Furniture Co., Walkerville, Ont. *Advt.* p. 225.
- 2957—SEATS—Hall.**  
 Smart (Jas.) Mfg Co. Ltd., Brockville, Ont. *Advt.* 178.
- 2958—SEATS—Veneer Chair.** *See No.* 3652.
- 2959—SEATS — (In the white) Carriage, Buggy.**  
 Brooks, James & Co., London, Ont.  
 Simpson, I. & Co., Brantford, Ont.  
 Miner Carriage Mfg Co. Ltd., Granby, Que.
- 2960—SEATS—Church, School, Pews, Pulpits.**  
 Globe Furniture Co., Walkerville, Ont. *Adv.* p. 225.  
 Snider, John B., Waterloo, Ont. *Advt.* page 231.  
 Moffatt & Co., Carleton Place, Ont.  
 Button & Fessant, Wingham, Ont. *Advt.* page 251.  
 Rhodes, Curry & Co. Ltd., Amherst, N.S. *Advt.* 158.  
 Canadian Office & School Furniture Co. Ltd. (The), Preston, Ont. *Advt.* page 210.
- 2961—SEATS—(Iron) School, Ry. Station.**  
 Garth & Co., Montreal, Que. *Advt.* page 154.  
 Valleyfield Machine Works, Valleyfield, Que. *Advt.* page 191.  
 Carrier, Laine & Co., Levis, Que. *Advt.* page 150.  
 Bessette, J. & S., Iberville, Que.  
 Smart (Jas.) Mfg Ltd., Brockville, Ont. *Advt.* p. 178.  
 Ives, H. R. & Co., Montreal, Que. *Advt.* page 200.
- 2962—SECRETARIES—Cabinet.** *See Desks No.* 1155.

- 2963—SECTIONS—(Knife) Reaper & Mower.**  
 Whitman & Barnes Mfg Co., St. Catharines, Ont.
- 2964—SECURITIES — (Blank) Corporation, Engraved, Lithographed, Printed.** *See Engraving* 1295.
- 2965—SEDATIVES—Bronchical (Palmer's) Cerebral Comp.**  
 Parke, Davis & Co., Walkerville, Ont.
- 2966—SEEDS.** *See No.* 3856.
- 2967—SEED—Flax.**  
 Weir & Weir, St. Marys, Ont.  
 Taylor, S. J., Guelph, Ont.  
 Harriston Flax Mill, Harriston, Ont.  
 Livingston, J. & J., Baden, Ont.
- 2968—SEEDERS — Broadcast, Grass, Combination, Seeders & Harrows, Seeders & Sowers Combined.**  
 Moody Matthew & Sons, Terrebonne, Que. *Advt.* page 209.  
 Hamilton Mfg Co. (Peter), Peterboro, Ont. *Advt.* 209.  
 Noxon Bros. Mfg Co., Ingersoll, Ont.
- 2969—SEMIAPHORES—Railway.**  
 Brown, (G. & J.), Mfg Co., Belleville, Ont. *Advt.* 198.  
 Canada Spring & Switch Co., Montreal, Que. *Advt.* page 217.  
 Stewart, John, New Glasgow, N. S. *Advt.* page 222.  
 Piper, Noah L. & Son, Toronto, Ont.
- 2970—SEPARATORS—Cream.**  
 Robb Engineering Co. Ltd., Amherst, N. S. *See inside front cover.*  
 Lancaster Machine Works, Lancaster, Ont. *Advt.* page 248.  
 Richardson & Webster, St. Mary's, Ont.
- 2971—SEPARATORS—Potato (Hand).**  
 Moody, Matthew & Sons, Terrebonne, Que. *Advt.* 209.
- 2971a—SEPARATORS—Steam.**  
 Goubert Mfg Co. (The), Montreal, Que. *Advt.* p. 194.  
 Babcock & Wilcox Co., Montreal, Que. *Advt.* p. 194.
- 2972—SEPARATORS—Magnetic, Ore.**
- 2973—SEPARATORS—Milling.**
- 2974—SEPULCHRES—Artificial Stone.** *See No.* 3472.
- 2975—SETS—Croquet (Parlor & Lawn).**  
 Goulette, O. V., Gananoque, Ont. *Advt.* page 214.  
 Wesley, F. J. & Co., Toronto Junction, Ont.  
 Crawford, W. C., Tilbury Centre, Ont.
- 2976—SETS—Dessert (Plated) "Communion Servers".**  
 Simpson, Hall, Miller & Co., Montreal, Que. *Advt.* 203.  
 Ontario Silver Co., Humberstone, Ont.  
 Standard Silver Co., Toronto, Ont.
- 2977—SETS—"Perfect", Saw.**  
 Woodyatt, A. R. & Co., Guelph, Ont. *Advt.* p. 207.
- 2978—SETS—Saw.**  
 Woodyatt, A. R. & Co., Guelph, Ont. *Advt.* p. 207.

- Butterfield & Co., Rock Island, Que.  
 Drake, F. J., Belleville, Ont. *Advt. page 175.*  
 Dillon, R., Oshawa, Ont.
- 2979—SETS—Rivet, Self-Feeding Tubular, Bifurcated, Slotted.**  
 Parmenter & Bullock, Gananoque, Ont. *Advt. p. 199.*
- 2980—SETS—Rivet.**  
 Brown, Boggs & Co., Hamilton, Ont. *Advt. p. 193.*  
 Smart (Jas.) Mfg Co., Brockville, Ont. *Advt. p. 178.*  
 Parmenter & Bullock, Gananoque, Ont. *Advt. p. 199.*
- 2981—SETS—Brass Fire (Open Hearth).**  
 Hamilton Brass Mfg Co., Hamilton, Ont. *Advt. 168.*  
 Chadwick Bros., Hamilton, Ont. *Advt. page 206.*  
 Ives, H. R. & Co., Montreal, Que. *Advt. page 200.*  
 Morrison (Jas.) Brass Mfg Co., Toronto. *Advt. p. 157.*  
 Mitchell, Robert & Co., Montreal, Que. *Advt. p. 213.*
- 2982—SETS—Electrical, Testing.**  
 Royal Electric Co., Montreal. Que.
- 2983—SETS—(Iron) Fire.**  
 Dennis Wire & Iron Works, London, Ont. *Advt. 207.*
- 2984—SETTEES—Hall.** *See Hall Chairs No. 772.*
- 2985—SETTEES—Wire.**  
 Meadows, George B., Toronto, Ont.  
 Dennis Wire & Iron Works, London, Ont. *Advt. 207.*
- 2986—SHACKLES—Side Bar Spring.**  
 Gillies Geo. Mfg Co., Gananoque, Ont. *Advt. p. 156.*  
 Frost, W. H., Smith's Falls, Ont.
- 2987—SETTEES—Bamboo, Rattan.**  
*See No. 3156.*
- 2988—SETTEES—(Iron) Lawn, Park.**  
*See No. 2954.*
- 2989—SETTER—Axle.**  
 Jardine, A. B. & Co., Hespeler, Ont. *Advt. p. 217.*
- 2990—SHACKLES—(Log) Boom.**  
 Wallace, Wm., Three Rivers, Que. *Advt. page 216.*
- 2991—SHADES—(Window) Plain & Decorated.**  
 Menzie, Turner & Co., Toronto, Ont.
- 2992—SHADES—Glass Lamp, Fancy Glass.**  
 Lamont Glass Co., New Glasgow, N. S. *Advt. p. 231.*  
 Dominion Glass Works, Montreal, Que. *Advt. p. 221.*
- 2993—SHADES—Metal Lamp, Tin Electric Light & Gas.**  
 Garth & Co., Montreal, Que. *Advt. page 154.*  
 American Copper Co., Toronto, Ont. *Advt. p. 157.*  
 Mitchell, Robert & Co., Montreal, Que. *Advt. p. 213.*
- 2994—SHAFTING—Iron & Steel, Counter & Crank Shafts.**  
 Portland Rolling Mills, St. John, N.B. *Advt. p. 195.*  
 Brown, (G. & J.) Mfg Co., Belleville, Ont. *Advt. 198.*  
 Paxton, Tate & Co., Port Perry, Ont.  
 Myers, W. F. & J. W., St. John, N.B. *Advt. p. 163.*  
 Gardner, Rob't & Son, Montreal, Que.  
 Ontario Engine & Machine Co. Ltd., Toronto, Ont.  
*Advt. page 177.*  
 Bertram, John & Sons, Dundas, Ont. *Advt. page 161.*

- Fraser Bros., New Glasgow, N. S. *Advt. page 252.*  
 Miller Bros. & Toms, Montreal, Que. *Advt. page 197.*  
 Laurie Engine Co., Montreal, Que. *Advt. page 179.*  
 Carrier, Laine & Co., Levis, Que. *Advt. page 150.*  
 Kerr & Morgan, Montreal, Que. *Advt. page 220.*  
 Robb Engineering Co. Ltd., Amherst, N. S.  
*See inside front cover.*
- Macdonald & Co. Ltd., Halifax, N.S. *Advt. p. 256.*  
 Niel & Whitfield, Hamilton, Ont.  
 Three Rivers Iron Works, Three Rivers, Que.  
*Advt. page 179.*
- Nova Scotia Steel Co. Ltd., New Glasgow, N. S.  
 Matheson, I. & Co., New Glasgow, N.S. *Advt. 200.*  
 Mac Machine Co., Belleville, Ont. *Advt. page 194.*  
 Fleck, Alex. Jr., Ottawa, Ont. *Advt. page 252.*  
 Valleyfield Foundry & Machine Works, Valleyfield, Que. *Advt. page 191.*  
 Reney, Reed & Selby, Kingston, Ont.  
 McOuatt & McRae, Lachute, Que. *Advt. page 205.*  
 Bessette, J. & S., Iberville, Que.  
 Vidal, Fils & Cie., Quebec, Que. *Advt. page 205.*  
 Brush, Geo., Montreal, Que.  
 Young, Andrew, Montreal, Que. *Advt. page 248.*  
 Wilson, J. C. & Co., Glenora, Ont.
- 2995—SHAFTS—(Shoe Factory) Brush.**  
*See Boot and Shoe Machines 2119.*
- 2996—SHAFTS—Counter, Crank.**  
*See Shafting No. 2994.*
- 2997—SHAFTS—Locomotive Rocker.**  
 Canadian Locomotive & Engine Co. Ltd., Kingston, Ont. *Advt. page 175.*  
 Rathbun Co. (The), Deseronto, Ont. *Advt. p. 162.*
- 2998—SHAFTS—Conveyor.**  
 Miller Bros. & Toms, Montreal, Que. *Advt. p. 197.*  
 Kerr & Morgan, Montreal, Que. *Advt. page 220.*  
 Goldie & McCulloch, Galt, Ont. *Advt. page 159.*
- 2999—SHAKERS—Milk.**  
 Smart (Jas.) Mfg Co., Brockville, Ont. *Advt. p. 178.*
- 3000—SHAKERS—Stove.** *See No. 3316.*
- 3001—SHAMS—Pillow.**  
 Allen Mfg Co., Toronto, Ont.
- 3002—SHANKS—(Vehicle), Step.**  
 Swansea Forging Co. Ltd., Swansea, Ont. *Advt. 156.*
- 3003—SHANKS—(Wood) Shoe.**  
 Lewis, J. & Son, Truro, N.S.
- 3004—SHANKS—(Iron) (Steel) Shoe.**  
 Kieffer Bros., Montreal, Que.  
 Hocking, Thomas, Montreal, Que.
- 3005—SHANKS—(Leather) Shoe.**  
 Richard & Co., Quebec, Que.
- 3006—SHAPERS—(Iron) Attachments.**  
 Bertram, John & Sons, Dundas, Ont. *Advt. page 161.*  
 Stevens, Hamilton & Co., Galt, Ont.
- 3007—SHAPES—Hat & Bonnet.** *See No. 1683.*
- 3008—SHARPENERS—Knife (Mower & Reaper).**  
 Whitman & Barnes Mfg Co., St. Catharines, Ont.  
 Smart (Jas.) Mfg Co., Brockville, Ont. *Advt. p. 178.*

**3009—SHARPENERS—(Saw) Automatic.**

Ballantine, John & Co., Preston, Ont. *Advt. p. 205.*  
Hart Emery Wheel Co., Hamilton, Ont. *Advt. 166.*  
Drake, F. J., Belleville, Ont. *Advt. page 175.*  
Prescott Emery Wheel Co., Precott, Ont. *Advt. 237.*

**3010—SHARPENERS—(Emery Saw) "Toleman's", "Rogers".**

Hart Emery Wheel Co., Hamilton, Ont. *Advt. p. 166.*

**3011—SHARPENERS—Scythe.**

Cooke Hardware Co., Hamilton, Ont. *Advt. p. 166.*

**3012—SHAVES — Coopers, Barrel, Wagon Maker', Spoke.**

Smart (Jas.) Mfg Co., Brockville, Ont. *Advt. p. 178.*  
Wannock, James, & Co., Galt, Ont.  
Broad, E. Sons & Co. Ltd., St. Stephen, N.B.

**3013—SHAVINGS—Cork.**

Cork Co. of Canada Ltd., Toronto, Ont. *Advt. p. 187.*  
Doyle, J. E. & Co., Montreal, Que. *Advt. page 235.*

**3014—SHAWLS—Wool.**

Paton Mfg Co., Sherbrooke, Que.  
McLean, James, Pembroke, Ont.

**3015—SHAWLS—Lap.**

Campbell, A., Markham, Ont.

**3016—SHEARS—(Hand) Metal Workers'.**

*See No. 2630.*

**3017—SHEATHING—Straw.**

Dominion Leather Board Co., Montreal, Que.

**3018—SHEATHING — (Paper) Waterproof, Plain, Tarred.**

Paterson Mfg Co. Ltd., Toronto, Ont., Montreal, Que.

**3019—SHEATHING—Asbestos.**

Berry, M. B., Quebec, Que.  
Sclater Asbestos Mfg Co., Montreal, Que. *Advt. 172.*

**3020—SHEAVES—Sliding Door.**

Smart (Jas.) Mfg Co., Brockville, Ont. *Advt. p. 178.*

**3021—SHEAVES—Lignumvitae, Hawsing.**

Bradley Bros., St. John, N.B.  
Frizzell, Alexander, Halifax, N.S.

**3022—SHEARS—(Power) Alligator, Metal, Saw.**

Waring, White & Co., St. John, N.B. *Advt. page 256.*  
Bertram, John & Sons, Dundas, Ont. *Advt. p. 161.*  
Ballantine, John & Co., Preston, Ont. *Advt. page 205.*

**3023—SHEAVES—(Iron) Wire Rope, Chain, Rope, Block.**

Myers, W. F. & J. W., St. John, N.B. *Advt. page 163.*  
Brown (G. & J.) Mfg Co., Belleville, Ont. *Advt. 198.*  
Wilson, James, Merrittton, Ont.  
Mac Machine Co., Belleville, Ont. *Advt. page 194.*  
Dominion Wire Rope Co., Montreal, Que. *Advt. 171.*  
Beatty, M. & Sons, Welland, Ont. *Advt. page 173.*  
Parker, Moses, Montreal, Que. *Advt. page 197.*  
Lunenburg Iron Co. Ltd., Lunenburg, N.S.  
Fleck, Alex., Jr., Ottawa, Ont. *Advt. page 252.*  
Dobbie & Stuart, Thorold, Ont.

**3024—SHEETING—(Rubber) Nursery, Hospital.**

Canadian Rubber Co., Montreal, Que. *Advt. page 197.*  
Gutta Percha & Rubber Mfg Co. Ltd., Toronto, Ont.  
*See back cover.*

**3025—SHEETING—Woolen.**

Humphrey, John & Son, Moncton, N.B.

**3026—SHEETINGS—Cotton, Twill, Towelling.**

Dominion Cotton Mills Co., Montreal, Que. *Advt. 181.*  
Gibson, Alex. & Sons Ltd., Marysville, N.B.  
Montmorency Cotton Mfg Co., Montmorency Falls.

**3027—SHELLACS.**

Canada Paint Co., Montreal, Que. *Advt. page 221.*  
Ramsay, A. & Son, Montreal, Que. *Advt. page 211.*  
Farr, J. H. & Co., Toronto, Ont. *Advt. page 211.*  
McCaskill, Dougall & Co., Montreal, Que. *Advt. 245.*  
Dods, P. D. & Co., Montreal, Que.  
MacKenzie, D. A. & Co., Toronto, Ont. *Advt. p. 243.*  
Baylis Mfg Co., Montreal, Que.  
Scarfe & Co., Brantford, Ont.

**3028—SHELLERS—Corn.**

Moody, Matthew & Sons, Terrebonne, Que. *Advt. 209.*  
Walker Co'y. (The), Belleville, Ont.  
Otterville Mfg Co. Ltd., Otterville, Ont. *Advt. p. 259.*  
Goldie & McCulloch Co., Galt, Ont. *Advt. page 159.*

**3029—SHELLS—(Rubber) Telephone, Squillees.**

Canadian Rubber Co., Montreal, Que. *Advt. p. 197.*

**3030—SHELLS — (Ammunition) Brass & Paper, Loaded Paper.**

Dominion Cartridge Co., Montreal, Que. *Advt. 196.*

**3031—SHELLS—Push-Button, Brass, Copper.**

Chadwick Bros., Hamilton, Ont. *Advt. page 206.*

**3032—SHELVES—(Book) Bamboo.**

Gendron Mfg Co., Toronto, Ont. *Advt. page 187.*  
Thompson, Alex. & Co., Hamilton, Ont.

**3033—SHELVES—Veneere, Basket, Crate.**

Oakville Basket Co., Oakville, Ont. *Advt. page 234.*

**3034—SHELVES—Slate.**

Burns & Co., Halifax, N.S.

**3035—HELVINGS—(Dairy) Slate.**

New Rockland Slate Co., Montreal, Que. *Advt. 244.*

**3036—SHELVING—Cupboard, Office & Book.**

Rathbun Co. (The), Deseronto, Ont. *Advt. p. 162.*  
Edwards, W. C. & Co., Ottawa, Ont. *Advt. p. 219.*  
Rhodes, Curry & Co., Amherst, N.S. *Advt. p. 158.*

**3037—SHIELDS—Rubber & Nipple.**

*See No. 2869.*

**3038—SHIELDS—Dress.**

Williamson Rubber Co., Toronto, Ont.

**3039—SHIELDS—Spun Metal. *See No. 3031.*****3040—SHINGLES—Shaved (Hand Made.)**

Hay Bros., Lachute, Que.

**3041—SHINGLES.**

Atkinson, Henry, Etchemin, Que. *Advt. page 222.*

Cane & Sons Mfg Co. Ltd. (The Wm), Newmarket, Ont. *Advt. page 218.*  
 Dickson & Co. (The), Peterboro, Ont. *Advt. p. 250.*  
 Deutschmann, Fred., Teeswater, Ont. *Advt. p. 218.*  
 Edwards, W. C. & Co. Ltd., Ottawa, Ont. *Advt. 219.*  
 Pembroke Lumber Co., Pembroke, Ont. *Advt. 216.*  
 Playfair, Jas. & Co., Midland, Ont. *Advt. page 223.*  
 Rathbun Co.(The), Deseronto, Ont. *Advt. page 162.*  
 Rhodes, Curry & Co., Amherst, N.S. *Advt. p. 158.*  
 St. Anthony Lumber Co., Ottawa, Ont. *Advt. p. 216.*  
 Gravel, A. Lumber Co., Etchemin, Que. *Advt. p. 215.*  
 Eastman Lumber Co., Eastman, Que.  
 Hawkesbury Lumber Co. Ltd., Hawkesbury, Ont.  
 Klock, R. H. & Co., Aylmer, Que.  
 Murphy, J. E., Hepworth Station, Ont.  
 Vance, James, Hepworth Station, Ont. *Advt. p. 256.*  
 Cookshire Mills Co., Cookshire, Que.  
 Copping, William, Joliette, Que.  
 Champoux, John, D'Israeli, Que.  
 Cutler & Savidge Co., Kenabutch Station, Ont.  
 Davidson, D., Penetanguishene, Ont.  
 Conlin, J. & T., Thorold, Ont.  
 Bedard, Joseph, Richmond, Que.  
 King, S. T. & Sons, Millford, N. B.  
 Imperial Lumber Co. Ltd.(The), Toronto, Ont.  
 Hastings Shingle Mfg Co., Hastings, B. C.  
 Hutchison, E., Chatham, N. B.  
 Hickson, Wm. A., Newcastle, N. B.  
 Gilmour & Co., Trenton, Ont.  
 Gilmour & Hughson, Hull, Que.  
 Georgian Bay Lumber Co. Ltd., Waubaushene, Ont.  
 Gibson, Alex. & Sons Ltd., Marysville, N. B.  
 Comtois & Co., Drummondville, Que.  
 Fiske, Edward, Joliette, Que.  
 Estey, R. A., Fredericton, N. B.  
 Drummondville Lumber Co., Forestdale, Que.  
 Doig, John, Lindsay, Ont.  
 Cass Bros., Martinville, Que.  
 Church, Michell & Fee, Mitchell Station, Que.  
 Canada Lumber Co., Carleton Place, Ont.  
 Beck, C. Mfg Co., Penetanguishene, Ont.  
 Bronsons, & Weston Lumber Co., Ottawa, Ont.  
 Baril, F., Warwick, Que.  
 Brunette Saw Mill Co., New Westminster, B. C.  
 Basinet, Chas., St. Jean de Matha, Que.  
 Beausolois, E., St. Gabrielle de Brandon, Que.  
 Allen, I., Mississippi Station, Ont.  
 Kidd, John, Wiarton, Ont.  
 King, G. G. & W. C., Chipman, N. B.  
 Leonard & Morin, Garthly, Que.  
 Law, W. J., Victoria Harbor, Ont.  
 Lawson, W. H., Park Head, Ont.  
 Longford Lumber Co., Longford Mills, Ont.  
 Moore Fred. & Sons, Woodstock, N.B.  
 McLachlin Bros., Arnprior, Ont.  
 Miller & Woodman, St. John, N.B.  
 Maitland, Rixon & Co., Owen Sound, Ont.  
 McDonald, D. B., South Indian, Ont.  
 Mason, Wm. & Sons, Ottawa, Ont.  
 McGibbon, F. & Sons, Penetanguishene, Ont.  
 Sadler, Dundas & Flavell Milling Co., Lindsay, Ont.  
 MacLaren, James, (Estate of), Buckingham, Que.  
 Miller, Charles, St. John, N.B.  
 Meredith, J. K., South Indian, Ont.  
 Murray, W. H., St. John, N.B.  
 Miller, Chas., St. John, N.B.  
 Pickard & Rowan, Owen Sound, Ont.  
 Allen, Robert, Snow Road, Ont.  
 Rousseau, J. A., St. Anne de la Pérade, Que.  
 Ross Bros., Buckingham, Que.  
 Red Cedar Lumber Co., Victoria, B.C.  
 Sawyer, A. H., Benton, N.B.

Shuswap Milling Co., Kamlopps, B.C.  
 Spicer, H. H. & Co., Vancouver, B.C.  
 Shives, Kelgour, Campbellton, N.B.  
 Seaman & Newman, Wiarton, Ont.  
 Schell, Macpherson & Co., Sayabec, Que.  
 Stetson, Cutler & Co., St. John, N.B.  
 Taylor, John, Magog, Que.  
 Tanguay, Chas., Weeden, Que.  
 Tangua, N. P., Weeden, Que.  
 Thompson & Avery, Sharbot Lake, Ont.  
 Thompson, W. R., Teeswater, Ont.  
 Tait, W. L., Vancouver, B.C.  
 Tait, A., Orillia, Ont.  
 Victoria Harbor Lumber Co., Victoria Harbor, Ont.  
 Wilson, S. B. & Son, Louise, Ont.  
 White, A. & P., Pembroke, Ont.  
 Wenger, N. & Bros., Ayton, Ont.  
 Whaley Lumber Co. Ltd., Huntsville, Ont.  
 Young, Wm., Wiarton, Ont.

**3042—SHINGLES—Metal.** *See No. 2856.*

**3043—SHIPS—Steel & Iron.**

Matheson, I. & Co., New Glasgow, N.S. *Advt. p. 200.*  
 Carrier, Laine & Co., Levis, Que. *Advt. page 150.*  
 Rathbun Co. (The), Deseronto, Ont. *Advt. page 162.*  
 Hamilton Bridge Co., Hamilton, Ont.  
 Bertram Engine Works Co., Toronto, Ont.

**3044—SHIRTINGS—Cotton, Drill, Gingham.**

Parks, William & Sons, St. John, N.B. *Advt. p. 233.*  
 Dominion Cotton Mills Co., Montreal, Que. *Advt. page 181.*  
 Canadian Colored Cotton Mills Co., Montreal, Que. *Advt. page 181.*

**3045—SHIRTS—Knit, Top.**

Schofield Woolen Co. (The), Oshawa, Ont.

**3046—SHIRTS & DRAWERS—Balbriggan.**

Eagle Knitting Co., Hamilton, Ont. *Advt. page 184.*

**3047—SHIRTS, COLLARS & CUFFS—Laundried, Unlaundried, Cotton, Night, Working, Colored, White, Outing.**

Williams, Greene & Rome Co., Berlin, Ont.  
 Skelton, Bros. & Co., Montreal, Que.  
 Tooke Bros., Montreal, Que.  
 Standard Shirt Co., Montreal, Que.  
 Van Allen E. & Co., Hamilton, Ont.  
 Sims, A. H. & Co., Montreal, Que.

**3048—SHODDY—See No. 3281.**

**3049—SHOES—(Loom), Picking.**

Paul, Frind Woolen Machinery Co., Toronto, Ont. *Advt. page 249.*

**3050—SHOES—Sleigh.**

Swansea Forging Co. Ltd., Swansea, Ont. *Advt. 156.*

**3051—SHOES—Iron Brake, Car Brake.**

Carrier, Laine & Co., Levis, Que. *Advt. page 150.*  
 Brown (G. & J.) Mfg Co., Belleville, Ont. *Advt. 198.*  
 Fleck, A., Jr., Ottawa, Ont. *Advt. page 252*  
 Garth & Co., Montreal, Que. *Advt. page 154.*  
 Ives, H. R. & Co., Montreal, Que. *Advt. page 200.*  
 Fleming, James, St. John, N.B.

**3052—SHOES—Hunting, Cork Sole, Gymnasium, Athletic, Patent Leather.**

Ames, Holden Co. Ltd., Montreal, Que. *Advt. p. 228.*  
 Seguin, Lalime & Co., St. Hyacinthe, Que.

**3053—SHOES—Felt, Leather Fox, Felt Lined.**

Berlin Felt Boot Co. (The), Berlin, Ont.

**3054—SHOES—Canvas.** See No. 3052.

**3055—SHOES—Snow.** See No. 1354.

**3056—SHOES—(Rubber) Lumbermen's, Tennis.**

Granby Rubber Co. Ltd., Granby, Que.  
Canadian Rubber Co., Montreal, Que. *Advt. p.* 197.  
Globe Rubber Co. (The), Quebec, Que.  
Rubber Shoe Co. (The), Toronto, Ont.

**3057—HORSE SHOES.**

Abbott & Co., Montreal, Que. *Advt. page* 196.  
Montreal Rolling Mills Co., Montreal, Que. *Advt.* 174.  
Portland Rolling Mills Co., St. John, N.B. *Advt.* 195.

**3058—SHOOKS — (Knock Down) Veneer, Berry.** See *Baskets No.* 160.

**3059—SHOOKS—(Knock Down) Box, Crate.**

Rathbun Co. (The), Deseronto, Ont. *Advt. page* 162.  
Edwards, W. C. & Co. Ltd., Ottawa, Ont. *Advt. p.* 219.  
Ontario Box Co. Ltd., Hamilton, Ont.  
Gilmour & Co., Trenton, Ont.  
Firstbrook Bros., Toronto, Ont.  
Watson's Box Factory, London, Ont.  
Flewelling Mfg Co. (G. & G.), Hampton, N. B.  
Esplin, G. & J., Montreal, Que.  
Edson Fitch Co. (The), Etchemin, Que.  
Ainsley Bros., Comber, Ont.

**3060—SHOT—Buck & Chilled.**

Ontario Lead & Barb Wire Co. Ltd., Toronto, Ont. *Advt. page* 177.  
Montreal Rolling Mills Co., Montreal, Que. *Advt.* 174.

**3061—SHOVELS—Toy Seaside.**

Davidson Mfg Co. (Thos), Montreal, Que. *Advt.* 225.

**3062—SHOVELS—Steam.**

Beatty, M. & Sons, Welland, Ont. *Advt. page* 173.

**3063—SHOVELS—(Steel) Snow, Sawdust.**

Skinner & Co., Gananoque, Ont. *Advt. page* 255.  
Jones Mfg Co. Ltd. (D. F.), Gananoque, Ont.  
Halifax Shovel Co., Halifax, N. S.

**3064—SHOVELS—(Iron & Brass) Fire.**

See No. 2981.

**3065—SHOVELS—(Wood) Snow, Veneer.**

Cane & Sons Mfg Co. Ltd. (The Wm.), Newmarket, Ont. *Advt. page* 218.  
Otterville Mfg Co. Ltd., Otterville, Ont. *Advt. p.* 259.  
Gelinis, C. P. & Bro., Three Rivers, Que.  
Smith & Henderson, Blenheim, Ont.  
Still, J. H., St. Thomas, Ont.  
Strathroy Mfg Co. Ltd. (The), Strathroy, Ont.  
Wesley, F. J. & Co., Toronto Junction, Ont.

**3066—SHRINKERS—Tire.**

Jardine, A. B. & Co., Hespeler, Ont. *Advt. p.* 217.  
Smart (Jas.) Mfg Co., Brockville, Ont. *Advt. p.* 178.  
Butterfield & Co., Rock Island, Que.

**3067—SHUCKERS—Buckwheat.** See No. 2920.

**3068—SHUNTS—Galvanometer.**

Ness, McLaren & Bate, Montreal, Que. *Advt. p.* 240.

Canadian General Electric Co. Ltd., Toronto, Ont.  
Toronto Electrical Works, Toronto, Ont.

**3069—SHUTTERS—Wood.** See No. 2898.

**3070—SHUTTERS—Window (Fire-Proof).** See No. 2856.

**3071—SHUTTERS—(Iron) Rolling.**

Macdonald, J. K., Montreal, Que. *Advt. page* 247.  
Dominion Bridge Co., Montreal, Que. *Advt. p.* 195.  
Carrier, Laine & Co., Levis, Que. *Advt. page* 150.

**3072—SHUTTLES—Carpet, Woolen, Cotton.**

Hope, John, Lachute, Que. *Advt. page* 188.

**3073—SHUTTLES—(Sewing Machine).**

Raymond, Chas., Guelph, Ont.

**3074—SIDEBOARDS—Dining Room.**

See No. 1506.

**3075—SIDING—Car.** See No. 1436.

**3076—SIDING—Corrugated Metal, Iron, Steel, Sheet-Steel, Elevator.** See No. 528.

**3077—SIENNAS—Burnt & Raw.**

Canada Paint Co., Montreal, Que. *Advt. page* 221.  
Argall, J. & Sons, Three Rivers, Que.

**3078—SIEVES — (Wire Cloth) Ash, Coal, Druggists, Flour.**

Davidson Mfg Co. (Thos), Montreal, Que. *Advt.* 225.  
Meadows, George B., Toronto, Ont.

**3079—SIFTERS — Lozenge (Con'fy M'chy) Cream Mixers, Candy Cooler.**

Malloch, William & Co., London, Ont.

**3080—SIFTERS—Flour.**

Chown, W. W. & Co., Belleville, Ont. *Advt. p.* 233.  
Smart (James) Mfg Co., Brockville, Ont. *Advt.* 178.  
Davidson Mfg Co. (Thos), Montreal, Que. *Advt.* 225.

**3081—SIGNALS — Automatic Street, Automatic Block.**

Canada Spring & Switch Co. Ltd., Montreal, Que. *Advt. page* 217.  
Piper, Noah L. & Son, Toronto, Ont.

**3082—SIGNALS—Electric Mine.**

Kay Electric Works, Hamilton, Ont. *Advt. p.* 233.  
Starr, John Son & Co., Halifax, N. S.

**3083—SIGNS—Gold Lettered, Silver Lettered.**

Elliott & Son, Toronto, Ont.

**3084—SIGNS—Advertising, Illuminated.**

Davidson Mfg Co. (Thos.), Montreal, Que. *Advt.* 225.

**3085—SIGNS—Brass.**

Patterson & Heward, Toronto, Ont. *Advt. page* 201.  
Pritchard & Andrews, Ottawa, Ont. *Advt. page* 250.

**3086—SIGNS—Glass.**

Ramsay, A. & Son, Montreal, Que. *Advt. page* 211.  
Hobbs Mfg Co., London, Ont. *Advt. page* 212.  
Lyon, N. T., Toronto, Ont. *Advt. page* 321.

**3087—SIGNS—Wire.**

Munro Bros., New Glasgow, N. S. *Advt. page* 244.  
Dennis Wire & Iron Works, London, Ont. *Advt.* 207.

Meadows, George B., Toronto, Ont.  
Major Mfg Co., Montreal, Que.

**3088—SILKS—Spool, Upholstery, Rope, Knitting, Outline, Spun, Wash, Brocaded, Fancy, Raw, Printed, Organzine, Dress, Gros Grain, Broad, Surah, Filling, Crocheting, Lining, Tream, Thrown, Etching, Embroidery, Floss, Silk Threads, Silk Ribbens, Silk Mixtures.**

Belding, Paul & Co. Ltd., Montreal, Que. *Advt.* 183.  
Corticelli Silk Co Ltd., St. Johns, Que. *Advt.* p. 182.

**3089—SILLS—(Stone).** *See No.* 2235.

**3090—SILLS—(Iron) Door & Window.**

*See No.* 2013.

**3091—SILVERWARE—Stirling, Antique.**

Ontario Silver Co., Humberstone, Ont.

**3092—SILVERWARE—(Plated) Flat, Hollow, Hotel.**

Simpson, Hall, Miller & Co., Montreal, Que. *Advt.* 203.  
Ontario Silver Co., Humberstone, Ont.  
Meriden Britannia Co., Hamilton, Ont.  
Standard Silver Co. Ltd., Toronto, Ont.

**3093—SINKS—(Porcelain) Kitchen, Pantry.**

Dominion Sanitary Pottery Co., St. Johns, Que.  
Malcolm, W. B., Toronto, Ont.

**3094—SINKS—Enamelled, Galvanized, Japanned.**

Young & Bro. Co. Ltd., Hamilton, Ont. *Advt.* 257.

**3095—SINKS—(Iron) Stable.** *See No.* 1831.

**3096—SINKS—Copper.**

Booth Copper Co., Toronto, Ont. *Advt.* page 155.  
Coulter & Campbell, Toronto, Ont. *Advt.* page 201.  
Garth & Co., Montreal, Que. *Advt.* page 154.  
Parker, J. O. & Co., Toronto, Ont. *Advt.* page 253.

**3097—SINKS—Iron & Steel.**

Carrier, Laine & Co., Levis, Que. *Advt.* page 150.  
Rodden, Wm. & Co., Montreal, Que.  
Connell Bros., Woodstock, N.B.  
Joliette Foundry Co., Joliette, Que.  
Gurney Foundry Co. Ltd., Toronto, Ont.  
Gurney, Tilden Co. Ltd., Hamilton, Ont. *Advt.* 151.  
Garth & Co., Montreal, Que. *Advt.* page 154.  
Macdonald Mfg Co., Halifax, N.S. *Advt.* page 256,  
McOuat & McRae, Lachute, Que. *Advt.* page 205.  
Enterprise Foundry Co. (The), Sackville, N.B.  
Crossman & Laws, Amherst, N.S. *Advt.* page 226.  
Toronto Foundry Co., Toronto, Ont.  
Smart (James) Mfg Co., Brockville, Ont. *Advt.* 178.  
Morrison Brass Mfg Co. (James), Toronto, Ont.  
*Advt.* page 157.

Ives, H. R. & Co., Montreal, Que. *Advt.* page 200.

**3098—SIPHONS—Metal.**

Coulter & Campbell, Toronto, Ont. *Advt.* page 201.

**3099—SIZE—Dry, "Church's".**

Alabastine Co. Ltd., Paris, Ont. *Advt.* page 212.

**3100—SIZE—Painters.**

Stuart, E. J., Montreal, Que.  
Fox, T. M., Montreal, Que.

**3101—SIZERS—Ore.**

Jenckes Machine Co., Sherbrooke, Que. *Advt.* p. 165.

**3102—SKATES—Ice.**

Starr Mfg Co. Ltd., Halifax, N. S. *Advt.* page 199.  
Forbes Mfg Co. Ltd., Halifax, N. S.  
Whelpley, J. A. & Co., Greenwich, N. B.

**3103—SKEINS—Wagon, Thimble.**

Gurney, Tilden Co. Ltd., Hamilton, Ont. *Advt.* 151.  
Workman & Ward Mfg Co., London, Ont.  
Smart, (Jas.) Mfg Co., Brockville, Ont. *Advt.* p. 178.  
Burrow, Stewart & Milne, Hamilton, Ont.

**3104—SKEWERS—Butchers'.**

Canada Bung & Spile Factory, Manotick, Ont.  
*Advt.* page 248.

Crawford, W. C, Tilbury Centre, Ont.

**3105—SKEWERS—Cotton Mill.**

Hambleton & Co., Hampton, N. B.  
Lachute, Shuttle & Bobbin Works, Lachute, Que.  
*Advt.* page 188.

**3106—SKIFFS—Fishing, Rowing, Racing.**

Gilbert, (N.), Boat Co., Brockville, Ont. *Advt.* p. 254.  
Knapp, A. C., Kingston, Ont. *Advt.* page 229.  
Canadian Canoe Co. Ltd., Peterboro, Ont.  
Cockburn, John & Son, Pembroke, Ont.

**3107—SKILLETS—Match (Veneer).**

Edson, Fitch Co. (The), Etchemin, Que.

**3108—SKINS—Cured.** *See No.* 3857.

**3109—SKINS—(Fur) Raw & Dressed.**

Canadian Manufacturer of Furs, Hair Point, Que.

**3110—SKIPS—Coal.**

Brown, (G. & J.) Mfg Co., Belleville, Ont. *Advt.* 198.

**3111—SKIVERS—Leather.**

Lancaster Machine Works, Lancaster, Ont. *Advt.* 248.  
Kieffer Bros., Montreal, Que.  
Pettener, B. J., Montreal, Que.

**3112—SKIVERS—Bookbinders'.**

Clarke, A. R. & Co., Toronto, Ont.

**3113—SKYLIGHTS—Metallic.**

Douglas Bros., Toronto, Ont. *Advt.* page 204.  
Metallic Roofing Co. of Canada Ltd. (The), Toronto,  
Ont. *See front fly leaf.*

**3114—SLABS—Marble, Plumbers', Stone.**

Canadian Granite Co. Ltd., Ottawa, Ont.  
Lyll, Peter & Sons Montreal, Que.

**3115—SLATE—Steps, Sills, Sinks, Plumbers', Curriers', Roofing, School Slates.**

New Rockland Slate Co., Montreal, Que. *Advt.* 244.  
Danville Asbestos & Slate Co., Danville, Que.

**3116—SLASHERS—Slab.**

Hamilton Mfg Co. Ltd. (Wm.), Peterboro, Ont.

**3117—SLATE WORK, Sanitary.**

New Rockland Slate Co. Montreal, Ont. *Advt.* p. 244.  
Mitchell, Robert & Co., Montreal, Que. *Advt.* p. 213.  
Morrison Jas. Brass Mfg Co., Toronto, Ont. *Advt.* 157.  
Burns & Co., Halifax, N.S.

**3118—SLATING—Liquid.**Gage Co. Ltd. (W. J.), Toronto, Ont. *Advt. p. 189.***3119—SLEDGES—Coal, Blacksmiths', Farriers', Stone.** *See No. 1644.***3120—SLEDS—Coasting.**Gendron Mfg Co. Ltd., Toronto, Ont. *Advt. p. 187.*  
Goulette, O. V., Gananoque, Ont. *Advt. page 214.*  
Dominion Snath Co., Waterville, Ont. *Advt. p. 241.***3121—SLEEVES—Rubber.** *See No. 2866.***3122—SLEIGHS—Children's.**Gendron Mfg Co. Ltd., Toronto, Ont. *Advt. page 187.*  
Goulette, O. V., Gananoque, Ont. *Advt. page 214.*  
Wesley, F. J. & Co., Toronto Junction, Ont.  
American Rattan Co., Toronto, Ont.**3123—SLEIGHS—Vehicle, Sleighs (Bob) One & Two Horses.**Kingston Vehicle Co., Kingston, Ont. *Advt. p. 202.*  
Ashley Carriage Works, Belleville, Ont. *Advt. p. 204.*  
Bain Bros. Mfg Co., Brantford, Ont. *Advt. page 249.*  
Auld, J. W., Hamilton, Ont.  
Campbell, John, London, Ont.  
Tudhope Carriage Co., Orillia, Ont.  
Crothers, Henderson & Wilson, St. John, N.B.  
Price & Shaw, St. John, N.B.  
Kelly & Murphy, St. John, N.B.  
Gray, William & Sons, Chatham, Ont.  
Lariviere, N. & A. C., Montreal, Que.**3124—SLICERS—Root,**Maxwell, David & Sons, St. Mary's, Ont. *Advt. 250.*  
Walker Co'y. (The), Belleville, Ont.  
Bell, B. & Son, St. George, Ont.  
Gowdy Mfg Co., Guelph, Ont.**3125—SLICERS—Vegetable.**Acme Veneer Works, Orillia, Ont. *Advt. page 217.*  
Davidson Mfg Co. Ltd. (Thos.), Montreal. *Advt. p. 225.*  
Kemp Mfg Co., Toronto, Ont.**3126—SLICERS—Bread & Cake, Fruit, Meat.**Acme Veneer Works, Orillia, Ont. *Advt. page 217.***3127—SLIDES—Breast Strap (Iron).**Smart (Jas.) Mfg Co., Brockville, Ont. *Advt. p. 178.*  
Kyle, P., Merrickville, Ont.  
Burrough, Stewart & Milne, Hamilton, Ont.**3128—SLINGS—Hay & Grain.** *See No. 647.***3129—SLIPPERS—Carpet, Felt Lined, Leather.**Ames, Holden Co. Ltd., Montreal, Que. *Advt. p. 228.*  
Amherst Boot & Shoe Mfg Co., Amherst, N. S.  
*Advt. page 229.*Berlin Felt Boot Co. (The), Berlin, Ont.  
Thompson Shoe Co. (The), Montreal, Que.  
Whitney & Brown, Montreal, Que.  
Packard, L. H. & Co., Montreal, Que.  
Aherns, Charles, & Co., Berlin, Ont.  
Jobin & Rochette, Quebec, Que.**3130—SMELTERS—Copper, Ore.**Jenckes Machine Co., Sherbrooke, Que. *Advt. p. 165.***3131—SMOKERS—Bee.**Goold, Shapley & Muir Co., Brantford, Ont.  
*Advt. page 191.*Phillips, H. & Co., Orillia, Ont. *Advt. page 259.*  
Russell, W. G., Millbrook, Ont.**3132—SNATHS—Scythe.**Skinner & Co., Gananoque, Ont. *Advt. p. 255.*  
Dominion Snath Co., Waterville, Que. *Advt. p. 241.***3133—SNUFF—Catarrh.**

Hawker, William &amp; Sons, St. John, N. B.

**3134—SNUFF—Black, Macaboy.**Ritchie, D. & Co., Montreal, Que.  
Houde, B. & Co., Quebec, Que.  
LeMesurier, John & Sons, Quebec, Que.**3135—SOAP—Oatmeal.**

Guelph Soap Co., Guelph, Ont.

**3136—SOAP—Soft Oil,**Farr, J. H. & Co., Toronto, Ont. *Advt. page 211.***3137—SOAP—Cottonseed Oil.**

Taylor, John &amp; Co., Toronto, Ont.

**3138—SOAP—Century.**Century Co., Pictou, Ont. *Advt. page 246.***3139—SOAP—Vaseline.**Chesebrough Mfg Co., Montreal, Que. *Advt. p. 259.***3140—SOAP—(Special Brands) "The Master Mechanics", "Baby's Own", "Harry Lewis Dog", "Queen's".**Albert Toilet Soap Co., Montreal, Que. *Advt. p. 248.***3141—SOAP—Toilet.**Albert Toilet Soap Co., Montreal, Que. *Advt. p. 248.*  
Pure Gold Mfg Co., Toronto, Ont.**3142—SOAP—Castile, Carbolic, Medicinal, Sulphur, Tar, Whale Oil.** *See No. 3140.***3143—SOAP—Laundry, Electric.**Century Co., Picton, Ont. *Advt. page 246.*  
Albert Toilet Soap Co., Montreal, Que. *Advt. p. 248.*  
Pure Gold Mfg Co., Toronto, Ont.  
Guelph Soap Co., Guelph, Ont.  
Wanzer Pure Soap Co., Hamilton, Ont.  
Strachan, W. & Co., Montreal, Que.  
St. Croix Soap Mfg Co., St. Stephen, N.B.  
Mott, John P. & Co., Halifax, N.S.  
Watts, A. & Co., Brantford, Ont.  
Elliot, J. & R., Galt, Ont.  
Welcome Soap Co. Ltd., St. John, N.B.**3144—SOAP—Electric.** *See No. 3143.***3145—SOAP—Antiseptic, (Actherial Johnsons).**

Park, Davis &amp; Co., Walkerville, Ont.

**3146—SOCKETS—(Carriage) Pole, Shaft.**Smart (James) Mfg Co., Brockville, Ont. *Advt. 178.***3147—SOCKETS—Row Lock.** *See No. 2027.***3148—SOCKETS—Whip.**McKinnon Dash & Hardware Co., St. Catharines, Ont. *Advt. page 202.*  
Smart (James) Mfg Co., Brockville, Ont. *Advt. 178.*  
Ives, H. R. & Co., Montreal, Que. *Advt. page 200.*

**3149—SOCKETS—Drill.** See No. 3206.

**3150—SOCKETS—Electric Lamp.**

Ness, McLaren & Bates, Montreal, Que. *Advt. p. 240.*  
Toronto Electrical Works, Toronto, Ont.  
Royal Electric Co., Montreal, Que.

**3151—SOCKETS—(Carriage Top) Bow.**

Gillies, George Co., (The) Gananoque, Ont. *Advt. p. 156.*  
Topliff, I. N. Mfg Co., St. Catharines, Ont.

**3152—SOCKETS—Colter (Plow).**

Smart (James) Mfg Co., Brockville, Ont. *Advt. 178.*  
Frost, W. H., Smith's Falls, Ont.  
Kyle, P., Merrickville, Ont.

**3153—SOCKS—Felt, Lumbermen's, Tufted.**

Berlin Felt Boot Co. (The), Berlin, Ont.

**3154—SOCKS & STOCKINGS—Lumbermen's.**

Ever Ready Dress Stay Co. (The), Windsor, Ont.  
Berlin Felt Boot Co. (The), Berlin, Ont.  
Taylor, T. H. Co. Ltd., Chatham, Ont. *Advt. p. 236.*  
Granite Mills, St. Hyacinthe, Que.  
Forbes Co. Ltd. (R.), Hespeler, Ont.

**3155—SODIUM—Nitrate, Oxalate, &c.**

—SODA—(Sulphate of).

Canada Chemical Mfg Co. Ltd., London, Ont.  
Victoria Chemical Co. Ltd. (The), Victoria, B.C.

**3655a—SODA—Sal, Bi-Carbonate.**

Cowan, Jno., Montreal, Que. *Advt. page 240.*

**3156—SOFAS—(Bamboo, Rattan) "Settees".**

Gendron Mfg Co. Ltd., Toronto, Ont. *Advt. p. 187.*  
American Rattan Co., Toronto, Ont.  
Thompson, A., Hamilton, Ont.

**3157—SOLDER—Gold & Silver.** See No. 2805.

**3158—SOLDER—Block, Plate, Strip, Spelter,  
Wire, Lead, Drop-Plumbers.**

Robertson Co. Ltd. (Jas.), Montreal, Que. *Advt. 167.*  
do do do Toronto, Ont. *Advt. p. 167.*  
do do do St. John, N.B. *Advt. p. 167.*  
do do do Winnipeg, Man. *Advt. 167.*  
Young & Bro. Co. Ltd., Hamilton, Ont. *Advt. p. 257.*  
Toronto Smelting & Refining Works, Toronto, Ont.  
*Advt. page 255.*

Robertson, Thomas & Co., Montreal, Que.  
Langwell, George & Son, Montreal, Que.  
Harris, C. C., Toronto, Ont.  
Montreal Rolling Mills Co., Montreal, Que. *Advt. 255.*

**3159—SOLES—Cork (Shoe).**

Cork Co. of Canada Ltd., Toronto, Ont. *Advt. p. 187.*  
Doyle, J. E. & Co., Montreal, Que. *Advt. page 235.*

**3160—SOLING—Rubber.** See No. 393.

**3161—SOLUTIONS—Medicinal, Chemical.**

Lyman Bros & Co. Ltd., Toronto, Ont.  
Stearns, Fred'k & Co., Windsor, Ont. *See back cover.*

**3162—SOLUTIONS—Camphor.**

Parke, Davis & Co., Walkerville, Ont.

**3163—SOUNDERS—Telegraph.**

Ness, McLaren & Bate, Montreal, Que. *Advt. p. 240.*

**3164—SOWERS—(Seed) Hand, Broadcast,  
Drill, Double-Drill.**

Moody, Matthew & Sons, Terrebonne, Que. *Advt. 209.*  
Maxwell, David & Sons, St. Marys, Ont. *Advt. 250.*  
Bell, B. & Son, St. George, Ont.  
Hamilton Mfg Co. (Peter), Peterboro, Ont. *Advt. 209.*

**3165—SPADES—Butter.**

Wesley, F. J. & Co., Toronto Junction, Ont.

**3166—SPARS—Ship's.**

Flood, N., Quebec, Que.  
Brunette Saw Mill Co. Ltd., New Westminster, B.C.  
White, E. I. & Son, Sand River, N. S.

**3167—SPARS—Ship (Steel & Iron).**

Matheson, I. & Co., New Glasgow, N. S. *Advt. p. 200.*

**3168—SPECIALS—Water Works.**

Jenckes Machine Co., Sherbrooke, Que. *Advt. p. 165.*

**3169—SPECIALITIES—Druggists.**

Stearns, Fred's & Co., Windsor, Ont. *See back cover.*

**3170—SPECULUMS—Rubber.** See No. 2869.

**3171—SPELTER—Hard, Soft, Zinc.**

Coulter & Campbell, Toronto, Ont. *Advt. page 201.*  
Toronto Smelting & Refining Works, Toronto, Ont.  
*Advt. page 255.*

**3172—SPICES—Ground—Spice Mixtures.**

Ewing, S. H. & A. S., Montreal, Que. *Advt. page 238.*  
Dunn, W. G. & Co., Hamilton, Ont.  
Brown & Webb, Halifax, N. S.  
Dearborn & Co., St. John, N. B.  
Dyson, Gibson Co. (The), Winnipeg, Man.  
Snow Drift Co., Brantford, Ont.  
Hamilton Spice & Coffee Co., Hamilton, Ont.  
Pure Gold Mfg Co., Toronto, Ont.  
Mott, John & Co., Halifax, N. S.  
Todhunter, Mitchell & Co., Toronto, Ont.

**3173—SPIDERS—(Cooking) Steel.** See No. 1739.

**3174—SPIKES—(Cut) Steel, Iron, Railroad,  
Track, Sidewalk, Boat, Vessel, Ship,  
Reverse Point, Wharf.**

Abbott & Co., Montreal, Que. *Advt. page 196.*  
Portland Rolling Mills, St. John, N.B. *Advt. p. 195.*  
Montreal Rolling Mills Co., Montreal, Que. *Advt. 174.*  
Swansea Forging Co. Ltd., Swansea, Ont. *Advt. 156.*  
Starr Mfg Co. Ltd., Halifax, N.S. *Advt. page 199.*  
Cowan & Britton, Gananoque, Ont.  
Pender James & Co. Ltd., St. John, N.B. *Advt. 208.*  
Burpee, I. & E. R., St. John, N.B.

**3175—SPILES—Liquid, Vent, Tap.**

Doyle, J. E. & Co., Montreal, Que. *Advt. page 235.*  
Canada Cork Cutting Co., Montreal, Que. *Advt. 223.*  
Cork Co. of Canada Ltd., Toronto, Ont. *Advt. p. 187.*  
Dickinson, G. N., Manotick, Ont. *Advt. page 248.*

**3176—SPINDLES—Saw.**

Thompson, Joseph, St. John, N.B.

**3176a—SPIRITS—Tin.**

Cowan, Jno., Montreal, Que. *Advt. page 240.*

**3177—SPIRITS—Cologne, Medicinal.**

Stearns, Fred'k & Co., Windsor, Ont. *See back cover.*  
Hamilton Vinegar Works, Hamilton, Ont.



**3178—SPITTOONS—Rubber.**Canadian Rubber Co., Montreal, Que. *Advt. p. 197.***3179—SPITTOONS—Rockingham Ware.**Campbell, R., Hamilton, Ont. *Advt. page 230.***3180—SPITTOONS—Stoneware.**Brantford Stoneware Mfg Co., Brantford, Ont.  
*Advt. page 251.*Campbell, R., Hamilton, Ont. *Advt. page 230.*  
Glass, Bros. & Co., London, Ont.  
Hart Bros. & Lazier, Belleville, Ont. *Advt. page 230.*  
Farrar, E. L., Iberville, Que.**3181—SPITTOONS—Nickle & Brass.**Chadwick Bros., Hamilton, Ont. *Advt. page 206.***3182—SPITTOONS—Iron.**Ives, H. R. & Co., Montreal, Que. *Advt. page 200.*  
Joliette Foundry Co., Joliette, Que.**3183—SPLINTS—Surgical.**

Gross, F., Montreal, Que.

**3184—SPLINTS—Match.**Edson Fitch Co. (The), Etchemin, Que.  
MacLaren Match Co. Ltd. (The), Buckingham, Que.**3185—SPLITTERS—Wood.**Jenckes Machine Co., Sherbrooke, Que. *Advt. p. 165.*  
Forest City Machine Works, London, Ont.**3186—SPLITTERS—Leather.**Woon, Robt. & Co., Oshawa, Ont. *Advt. page 210.***3187—SPOKES—(Wood), Wheel Wagon.**Chatham Mfg Co. Ltd., Chatham, Ont. *Advt. p. 245.*  
McVean, O. & W., Dresden, Ont.  
Victoria Wheel Works, Galt, Ont.  
Hore's, F. W. Sons, Hamilton, Ont.  
Canada Wheel Works, Merritton, Ont.**3188—SPOOLERS—Bobbin, Drum, Worsted, Wool.**Goldie & McCulloch Co. Ltd., Galt, Ont. *Advt. p. 159.*  
Karch, H. W., Hespeler, Ont.**3189—SPOOLS—(Thread & Silk), "Prepared Spool Wood."**Palbert, D., Lake Bouchette, Que.  
Delisle Bros., Lake Bouchette, (Lake St. John Ry, Que).  
Lemay, D., Lotbiniere, Que.  
Kneeland, S. K., Tangier, N. S.  
Restigouche Spool Co., Jacquet Revier, N. B.  
Conway, G. O. S., Stonefield, Que.  
Clark, Skilling & Co., Newcastle, N. B.**3190—SPOOLS—Electric Wire, Woolen Mill, Cotton Mill, Rope, Wire.**Thompson & Co., Sherbrooke, Que. *Advt. page 228.*  
Hope, John, Lachute, Que. *Advt. page 188.*  
Hambleton & Co., Hampton, N. B.**3191—SPOOLWOOD.**

Bigelow, A. &amp; Son, Lower Stewiacke, N. S.

**3192—SPOONS—Plated, Sterling Silver.***See No. 3092.***3193—SPOONS—Post Hole.**Welland Vale Mfg Co., St. Catharines, Ont. *Advt. 241.***3194—SPOUTS—(Iron), Pump, Tap.**Davidson Mfg Co. (Thos.), Montreal, Que. *Advt. 225.*  
Smart (James) Mfg Co., Brockville, Ont. *Advt. 178.*  
Lancaster Machine Works, Lancaster, Ont. *Advt. 248.*  
Woodyatt, A. R. & Co., Guelph, Ont. *Advt. p. 207.*  
Ives, H. R. & Co., Montreal, Que. *Advt. page 200.*  
McDougall, R. & Co., Galt, Ont. *Advt. page 199.***3195—SPRING—Gaiter.**

Hocking, Thomas, Montreal, Que.

**3196—SPRINGS—Bird Cage.**Smart (James) Mfg Co., Brockville, Ont. *Advt. 178.***3197—SPRINGS—Bed (Knock Down)**Townshend, J. E., Montreal, Que. *Advt. page 247.*  
Currie, W. & F. P., Montreal, Que.**3198—SPRINGS—Harrow.**Steel Harrow Co., New Glasgow, N.S.  
Nova Scotia Steel Co., Ltd., New Glasgow, N.S.**3199—SPRINGS—Special. See No. 3203.****3200—SPRINGS—(Wire) Furniture, Bed, Car Seat, Sofa, Chair, Cushion.**Munro Bros., New Glasgow, N. S. *Advt. page 244.*  
Currie, W. & F. P., Montreal, Que.  
Ellis Furniture Co., Ingersoll, Ont. *Advt. page 208.*  
Dennis Wire & Iron Works, London, Ont. *Advt. 207.***3201—SPRINGS—(Ry.), Coach, Locomotive, Freight Car, Passenger Car, Elliptic, Coil, Clip, Spiral.**Canada Spring & Switch Co., Montreal, Que. *Advt. page 217.*  
Coghlin, B. J., Montreal, Que.  
Warnock, James & Co., Galt, Ont.**3202—SPRINGS—(Vehicle), Steel, Carriage, Tempered, Wagon, Wagon Seat.**Gananoque Spring & Axle Co., Gananoque, Ont. *Advt. page 233.*  
Coghlin, B. J., Montreal, Que.  
Warnock, Jas. & Co., Galt, Ont.  
Campbell Bros., St. John, N. B.  
Nova Scotia Steel Co. Ltd., New Glasgow, N. S.**3203—SPRINGS—(Machinery), all kinds.**Canada Spring & Switch Co., Montreal, Que. *Advt. page 217.***3204—SPRINGS—Door, Window.**Ness, McLaren & Bate, Montreal, Que. *Advt. p. 240.***3205—SPRINGS—Umbrella, Suspender.**

Dunn, Patrick, Cote St. Paul, Que.

**3206—SPRINGS—Bicycle, (Drill Sockets).**

Whitman &amp; Barnes Mfg Co., St. Catharines, Ont.

**3207—SPRINGS—Glove "Storey's Eureka".**

Storey, W. H. &amp; Son, Acton, Ont.

**3208—SPRINGS—(Rubber) Car, Wagon.**Gutta Percha & Rubber Mfg Co. Ltd., Toronto, Ont. *See back cover.*  
Canadian Rubber Co., Montreal, Que. *Advt. p. 197.*

**3209—SPRINKLERS—(Street) Wood & Steel Tank.**

Smith Bros., Toronto, Ont. *Advt. page 178.*  
Speight Wagon Co. (The), Markham, Ont. *Advt. 245.*

**3210—SPRINKLERS—Automatic, Hand.**

Mitchell, Robert & Co., Montreal, Que. *Advt. p. 213.*  
Morrison James Brass Mfg Co., Toronto, Ont. *Advt. 157.*

**3211—SPRINKLERS — Garden & Lawn, Suction.**

Mitchell, Robert & Co., Montreal, Que. *Advt. p. 213.*  
Garth & Co., Montreal, Que. *Advt. page 154.*  
Parker, J. O. & Co., Toronto, Ont. *Advt. page 253.*  
Smart (James) Mfg Co., Brockville, Ont. *Advt. 178.*  
Young & Bro. Co. Ltd., Hamilton, Ont. *Advt. p. 257.*  
Macdonald & Co. Ltd., Halifax, N.S. *Advt. page 256.*  
Hamilton Brass Mfg Co., Hamilton, Ont. *Advt. p. 168.*  
Morrison Jas. Brass Mfg Co., Toronto, Ont. *Advt. 157.*

**3212—SQUEEZERS—Glass Lemon.**

Lamont Glass Co., New Glasgow, N. S. *Advt. p. 231.*  
Dominion Glass Works, Montreal, Que. *Advt. p. 221.*

**3213—SQUEEZERS—Lemon, Metal.**

Smart, (Jas.), Mfg Co., Brockville, Ont. *Advt. p. 178.*  
Ives, H. R. & Co., Montreal, Que. *Advt. page 200.*

**3214—SQUARES—(Wrought Iron) Trace.**

Skinner & Co., Gananoque, Ont. *Advt. page 255.*

**3215—STACKERS—Straw (Pneumatic).**

Sawyer & Massey Co. Ltd., Hamilton, Ont.  
Waterloo Mfg Co. Ltd., Waterloo, Ont. *Advt. p. 218.*

**3216—STACKS—Smoke (Boiler Plate).**

*See No. 341.*

**3217—STAINS — Paper, Water, Shingle, Leather Board, Mortar, Cherry, Mahogany, Walnut, Wood.**

Canada Paint Co., Montreal, Que. *Advt. page 221.*  
Ramsay, A. & Son, Montreal, Que. *Advt. page 211.*  
Howe, William, Ottawa, Ont. *Advt. page 201.*  
Argall, J. & Sons, Three Rivers, Que.  
Henderson & Potts, Halifax, N. S.

**3218—STAIRS—Steel.**

Central Bridge & Engineering Co. Ltd., Peterboro, Ont. *Advt. page 214.*

**3219—STAIRS—Iron, Spiral.**

Loignon, A. & E., Montreal, Que. *Advt. page 247.*  
Dennis Wire & Iron Works, London, Ont. *Advt. 207.*  
Carrier, Laine & Co., Levis, Que. *Advt. page 150.*

**3220—STAIRS—Slate.**

New Rockland Slate Co., Montreal, Que. *Advt. p. 244.*  
Burns & Co., Halifax, N. S.

**3221—STAIRS—Wood.**

Rhodes, Curry & Co., Amherst, N. S. *Advt. p. 158.*  
Edwards, W. C. & Co., Ottawa, Ont. *Advt. page 219.*  
Gilmour & Co., Trenton, Ont.  
Rathbun Co. (The), Deseronto, Ont. *Advt. page 162.*

**3222—STAKES—Tinnners'. *See No. 2630.***

**3223—STALKS—Whip.**

Lay Whip Co., Rock Island, Que.  
Rock Island Whip Co., Rock Island, Que.

**3224—STALLS—(Stable) Box.**

Tisdale Iron Fitting Co., Toronto, Ont. *Advt. p. 202.*

**3225—STAMPS—Butter. *See No. 2641.***

**3226—STAMPS — Autograph, Post Office, Numbering, Railroad, Rubber, Dating, Self-Inking, Office.**

Pritchard & Andrews, Ottawa, Ont. *Advt. page 250.*  
Patterson & Heward, Toronto, Ont. *Advt. page 201.*  
Tingley & Stewart Mfg Co., Toronto, Ont.  
Montreal Stencil Works, Montreal, Que.  
Fell, I. C. & Co., Toronto, Ont.

**3227—STAMPS—Bookbinders', Brass, Steel, (Seals).**

Pritchard & Andrews, Ottawa, Ont. *Advt. page 250.*  
Patterson & Heward, Toronto, Ont. *Advt. page 201.*  
Fell, I. C. & Co., Toronto, Ont.  
Dawson, G. W., Montreal, Que.  
Cox, George, Ottawa, Ont.

**3228—STANDARDS—Electric, Gas, Lamp.**

American Copper Co. (The), Toronto, Ont. *Advt. 157.*  
Young & Bro. Co. Ltd., Hamilton, Ont. *Advt. p. 257.*  
Mitchell, Robert & Co., Montreal, Que. *Advt. p. 213.*  
Garth & Co., Montreal, Que. *Advt. page 154.*

**3229—STANDS—Biscuit.**

Tees & Co., Montreal, Que. *Advt. page 225.*

**3230—STANDS—Sewing Machine.**

Raymond Charles, Guelph, Ont.

**3231—STANDS—(Railway) Switch.**

Brown (G. & J.) Mfg Co., Belleville, Ont. *Advt. 198.*  
Canada Spring & Switch Co. Ltd., Montreal, Que.

*Advt. page 217.*

Stewart, John, New Glasgow, N.S. *Advt. page 232.*  
Piper, Noah L. & Son, Toronto, Ont.

**3232—STANDS—Emery Grinder.**

Prescott Emery Wheel Co., Prescott, Ont. *Advt. 223.*  
Hart Emery Wheel Co., Hamilton, Ont. *Advt. 166.*

**3233—STANDS—Wash Adjustable. *See No. 168.***

**3234—STANDS—(Iron) Hot Water Boiler.**

McAvity, T. & Sons, St. John, N.B. *Advt. page 153.*  
Smart (James) Mfg Co., Brockville, Ont. *Advt. 178.*  
Garth & Co., Montreal, Que. *Advt. page 154.*  
Young & Bro. Co. Ltd., Hamilton, Ont. *Advt. p. 257.*  
Carrier, Laine & Co., Levis, Que. *Advt. page 150.*  
Ives, H. R. & Co., Montreal, Que. *Advt. page 200.*  
Gurney Foundry Co. Ltd., Toronto, Ont.  
Toronto Foundry Co., Toronto, Ont.

**3235—STANDS—(Brass) Umbrella, Foot.**

Hamilton Brass Mfg Co., Hamilton, Ont. *Advt. 168.*  
Morrison (J.) Brass Mfg Co., Toronto. *Advt. page 157.*  
Garth & Co., Montreal, Que. *Advt. page 154.*

**3236—STANDS—(Clay) Umbrella.**

**3237—STANDS—(Art Stone) Umbrella.**

Brantford Stoneware Mfg Co., Brantford, Ont.  
*Advt. page 251.*

**3238—STANDS—(Iron) Umbrella.**

Young & Bro. Co. Ltd., Hamilton, Ont. *Advt. 257.*  
Smart (James) Mfg Co., Brockville, Ont. *Advt. 178.*  
Ives, H. R. & Co., Montreal, Que. *Advt. page 200.*

**3239—STANDS—(Bamboo & Rattan) Umbrella, Music, Hall, Hat Rack, Work, Book, (Tables).**

Gendron Mfg Co., Toronto, Ont. *Advt. page 187.*  
Thompson, Alex. & Co., Hamilton, Ont.  
American Rattan Co., Toronto, Ont.  
Windsor Furniture Co., Windsor, N.S.

**3240—STANDS—(Wire) Basket.** *See No. 159.*

**3241—STANDS—(Iron) Ink.**

Smart (James) Mfg Co., Brockville, Ont. *Advt. 178.*

**3242—STANDS—Glass, Ink.**

Dominion Glass Works, Montreal, Que. *Advt. p. 221.*

**3243—STANDS—Copying Press.**

Tees & Co., Montreal, Que. *Advt. page 225.*  
Office Specialty Mfg Co., Toronto, Ont.

**3244—STANDS—Tub, Wringer.** *See No. 3825.*

**3245—STANDS—(Iron) Fire, Sad Iron, Tea & Coffee Pot.**

Woodyatt, A. R. & Co., Guelph, Ont. *Advt. p. 207.*  
Carrier, Laine & Co., Levis, Que. *Advt. page 150.*  
Smart, (Jas.) Mfg Co., Brockville, Ont. *Advt. p. 178.*  
Gurney, Tilden Co. Ltd. Hamilton, Ont. *Advt. p. 151.*  
Davidson Mfg Co. (Thos.), Montreal, Que. *Advt. 225.*  
Paris Alectro Plating Co., Paris Station, Ont.  
Ives, H. R. & Co., Montreal, Que. *Advt. page 200.*

**3246—STANDS—Bee Hive.** *See No. 1724.*

**3247—STANDS—(Safety) Bicycle.**

Goold Bicycle Co. Ltd., Brantford, Ont. *Advt. p. 220.*

**3248—STAPLES—Wrought, Wagon, Box, Blind.**

Cowan & Britton, Gananoque, Ont.  
Dunn, Patrick, Cote St. Paul, Que.  
Smart, (Jas.) Mfg Co., Brockville, Ont. *Advt. p. 178.*

**3249—STAPLES—(Wire) Barbed.** *See No. 2272.*

**3250—STARCH—Laundry, Potato.**

Brantford Starch Co., Brantford, Ont. *Advt. p. 246.*  
Edwardsburg Starch Co., Montreal, Que. *Advt. 246.*  
Farquharson, D. & Son, Charlottetown, P. E. I.  
McKinnon & McLean, Charlottetown, P. E. I.  
Full, George E., Charlottetown, P. E. I.

**3251—STARCH—Corn, Rice, Wheat.**

Edwardsburg Starch Co., Montreal, Que. *Advt. 246.*  
Brantford Starch Co., Brantford, Ont. *Advt. p. 246.*

**3252—STATIONARY—Commercial.**

Gage, (W. J.) Co., Toronto, Ont. *Advt. page 189.*  
Doust, Joseph, Toronto, Ont. *Advt. page 229.*  
Rolland, J. B. & Sons, Montreal, Que. *Advt. p. 189.*  
Brown Bros. Ltd. (The), Toronto, Ont.

**3253—STATUARY—Italian Marble, Granite.**

Toronto Granite Co. Ltd. (The), Toronto, Ont.

**3254—STAVES—Nail Keg.**

Rousseau, J. A., St. Anne de la Parade, Que.

**3255—STAVES — (Slack) Barrel, (Barrel Heading).**

Vance, Jas. Hepworth Station, Ont. *Advt. page 256.*

Steinhoff & Gordon, Wallaceburg, Ont. *Advt. p. 192.*  
Rathbun Co. (The), Deseronto, Ont. *Advt. page 162.*  
Deutschmann Fred., Teeswater, Ont. *Advt. page 218.*  
Thompson, W. R., Teeswater, Ont. *Advt. page 233.*  
Pardo, T. L., Cedar Springs, Ont.  
Coleman, T. T. (Estate of), Seaforth, Ont.  
DeCew, T. H., Essex, Ont.  
Matthews, W. H., Trenton, Ont.  
McLean & Son, Wingham, Ont.

**3256—STAYS—Dress.**

St. Lawrence Steel & Wire Co., Gananoque, Ont.  
*Advt. page 183.*  
Ever Ready Dress Stay Co. (The), Windsor, Ont.

**3257—STAYS—Dress "Ever Ready"**

Ever Ready Dress Stay Co. (The), Windsor, Ont.

**3258—STAYS—Barn Door, Smoke, Stack.**

Carrier, Laine & Co., Levis, Que. *Advt. page 150.*  
Young & Bro. Co. Ltd., Hamilton, Ont. *Advt. p. 257.*

**3259—STEAMERS—(Passenger) Ocean, Lake, River, Steamboats.**

Matheson, I. & Co., New Glasgow, N.S. *Advt. p. 200.*  
Rathbun Co. (The), Deseronto, Ont. *Advt. page 162.*  
King, C. C., Shelburne, N.S.  
Bertram Engine Works Co. Ltd., Toronto, Ont.  
Dry Dock & Wrecking Co., Collingwood, Ont.

**3260—STEAMERS—(Tin) Bread & Vegetable. —STEEPERS—Tea.**

Chown, W. W. & Co., Belleville, Ont. *Advt. page 233.*  
Kemp Mfg Co., Toronto, Ont.  
Davidson Mfg Co. (Thomas), Montreal, Que. *Advt. 225.*

**3261—SEAMERS—(Metal).** *See No. 2630.*

**3262—STEEL—Harrow Frame.** *See No. 3265.*

**3263—STEEL—(Bridge).** *See No. 3265.*

**3264—STEEL—Sheet Corrugated.** *See No. 2856.*

**3265—STEEL — Agricultural, Machinery, Merchants, Open Hearth, Rolled, Soft, Tire, Spring, Toe-Calk.**

Montreal Rolling Mills Co., Montreal, Que. *Advt. 174.*  
Portland Rolling Mills Co., St. John, N.B. *Advt. 195.*  
Nova Scotia Steel Co. Ltd., New Glasgow, N.S.

**3266—STEELS—(Emery) Butchers', "Carvers Friend", Household.**

Hart Emery Wheel Co., Hamilton, Ont. *Advt. p. 166.*  
Cook Hardware Co., Hamilton, Ont. *Advt. page 166.*

**3266a—STEELS—Capping.**

Mac Machine Co., Belleville, Ont. *Advt. page 194.*

**3267—STEELS—(Corset) Covered, Japanned, Dress.**

St. Lawrence Steel & Wire Co. Ltd., Gananoque, Ont. *Advt. page 183.*

**3268—STEELYARDS.**

Smart (James) Mfg Co., Brockville, Ont. *Advt. 178.*  
Gurney Scale Co., Hamilton, Ont. *Advt. page 244.*  
Burrow, Stewart & Milne, Hamilton, Ont.

**3269—STENCILS—Metal.** *See No. 3226.*

**3270—STEPS—(Vehicle) Malleable Iron.**

Kyle, P., Merrickville, Ont.

- Frost, W. H., Smith's Falls, Ont.  
Burrow, Stewart & Milne, Hamilton, Ont.
- 3271—STEPS—(Forged) Carriage, Sleigh, Wagon.**  
Gillies, George Co.; (The) Gananoque, Ont. *Advt. p. 156.*  
Swansea Forging Co. Ltd., Swansea, Ont. *Advt. 156.*
- 3272—STETHOSCOPES — Veterinary Instruments.**  
Clute, Chas., Toronto, Ont.  
Gross, F., Montreal, Que.  
Schneider, A. & Co., Toronto, Ont.
- 3273—STICKS—Lacrosse.**  
Lally, F., Cornwall, Ont.
- 3274—STICKS—Walking.**  
Gross, F. W., Montreal, Que.
- 3275—STICKS—Hockey.**  
Hilbourn, William, Ayr, Ont.  
Still, J. H., St. Thomas, Ont.
- 3276—STICKS—(Woolen Mill) Picker.**  
Hope, John, Lachute, Que. *Advt. page 188.*
- 3277—STIFFENERS—Boot & Shoe, Taps.**  
Richard & Co., Quebec, Que.  
Rochette, C., Quebec, Que.  
Blouin, Fidèle, Quebec, Que.
- 3278—STILLS—(Copper) Brewers', " Stills & Worms ", Distillers.**  
Booth, Copper Co., Toronto, Ont. *Advt. page 155.*  
Garth & Co., Montreal, Que. *Advt. page 154.*  
Coulter & Campbell, Toronto, Ont. *Advt. page 201.*  
Parker, J. O. & Co., Toronto, Ont. *Advt. page 253.*
- 3279—STIRRERS—(Cheese) Curd.**  
Lancaster Machine Works, Lancaster, Ont. *Advt. 248.*  
Macpherson, D. M., Lancaster, Ont.
- 3280—STOCK—Nursery (Trees).**  
Nova Scotia Nursery, Halifax, N.S.  
Stone & Wellington, Toronto, Ont.  
Graham, E. O., Toronto, Ont.
- 3281—STOCK—Wool, Shoddy, Wool Flock.**  
Bauer, A. & Co., Waterloo, Ont. *Advt. page 185.*  
Crawford, E., Guelph, Ont.  
Duncan, W. S., Stratford, Ont.  
Pollock, W. C., Almonte, Ont.  
Smith Wool Stock Co., Toronto, Ont.  
Robert, J. B., Beauharnois, Que.  
Shepherd, David, Almonte, Ont.  
New Toronto Wool Stock Co. (The), New Toronto.  
Canada Garnetting Co., Montreal, Que.  
Harding & Son, Simcoe, Ont.
- 3282—STOCKS & DIES—Blacksmith's, Pipe.**  
Jardine, A. B. & Co., Hespeler, Ont. *Advt. p. 217.*  
Butterfield & Co., Rock Island, Que.
- 3283—STOKERS—Automatic, Mechanical.**  
Babcock & Wilcox Co., Montreal, Que. *Advt. p. 194.*
- 3284—STONE—Lime.** *See No. 1995.*
- 3285—STONE—Monumental, Sawn.** *See No. 2235.*
- 3286—STONE—Riprap.**  
Gibson, William, Beamsville, Ont.

- 3287—STONE—Sawn.** *See No. 2235.*
- 3288—STONE—Abutment, Dimension, Building, Quarry, Rubble, Foundation, Ry. Culvert.**  
Fish, C. E., Newcastle, N. B. *Advt. page 229.*  
Adams, John, Longford Mills, Ont.  
Longford, Quarry Co., Longford, Mills, Ont.  
Gibson, William, Beamsville, Ont.  
Canadian Granite Co. Ltd., Ottawa, Ont.  
Montreal Quarry Co. (The), Montreal, Que.  
Toronto & Orillia Stone Quarry Co., Orillia, Ont.  
Bras D'Or Marble Co. Ltd. (The), Halifax, N. S.
- 3289—STONEWARE—Chemical.**  
Hart Bros. & Lasier, Belleville, Ont. *Advt. p. 230.*  
Glass Bros. & Co., London, Ont.  
Farrar, E. L., Iberville, Que.
- 3290—STONEWARE—Salt Glazed.**  
Brantford Stoneware Mfg Co., Brantford, Ont. *Advt. page 251.*
- 3291—STONES—Curling.**  
Gardner, Rob't & Sons, Montreal, Que.
- 3292—STONES—(Emery), Oil, Rub.**  
Prescott Emery Wheel Co. Ltd., Prescott, Ont. *Advt. page 237.*  
Hart Emery Wheel Co., Hamilton, Ont. *Advt. 166.*
- 3293—STONE—Wood Pulp.**  
Fish, C. E., Newcastle, N. B. *Advt. page 229.*
- 3294—STONES—Scythe.**  
Cooke Hardware Co., Hamilton, Ont. *Advt. p. 166.*
- 3295—STONES—(Slate), Imposing.**  
New Rockland Slate Co., Montreal, Que. *Advt. 244.*
- 3296—STOOLS—Counter.** *See No. 772.*
- 3297—STOOLS—(Camp), Folding.** *See No. 769.*
- 3298—STOOLS—(Wooden)—Revolving Office, Store, Office High, Foot.** *See No. 772.*
- 3299—STOOLS—(Foot), Fancy, Parlor.**  
Gendron Mfg Co. Ltd., Toronto, Ont. *Advt. page 187.*
- 3300—STOOLS—(Iron), Store, Revolving.**  
Ives, H. R. & Co., Montreal, Que. *Advt. page 200.*  
Smart (James) Mfg Co., Brockville, Ont. *Advt. 178.*  
Lancaster Machine Works, Lancaster, Ont. *Advt. 248.*
- 3301—STOOLS—Piano.**  
Otterville Mfg Co. Ltd., Otterville, Ont. *Advt. 259.*  
Foisy, Thomas F. G., Montreal, Que.  
Smith, W. P. & Co., Toronto, Ont.  
Bell Organ & Piano Co. Ltd. (The), Guelph, Ont.  
Goderich Organ Co., Goderich, Ont.  
Stafford & Rudd, Arnprior, Ont.
- 3302—STOOLS—(Brass) Piano.**  
Hamilton Brass Mfg Co., Hamilton, Ont. *Advt. 168.*
- 3303—STOPPERS—Glass Bottle.**  
Lamont Glass Co., New Glasgow, N.S. *Advt. p. 231.*
- 3304—STOPPERS—Bottle.**  
Freyseng, P. & Co., Toronto, Ont. *Advt. page 235.*  
Canada Cork Cutting Co., Montreal, Que. *Advt. 223.*  
Cork Co. of Canada, Toronto, Ont. *Advt. page 187.*

**3305—STOPPERS—Flue.**

Chadwick Bros., Hamilton, Ont. *Advt. page 206.*  
Davidson Mfg Co. (Thos), Montreal, Que. *Advt. 225.*

**3306—STOPPLES—Rubber.**

Canadian Rubber Co., Montreal, Que. *Advt. p. 197.*  
Alpha Rubber Co., Montreal, Que.

**3307—STOPS—(Iron) Barn Door, Bench, Sliding Door.**

Woodyatt, A. R. & Co., Guelph, Ont. *Advt. page 207.*  
Gurney, Tilden Co. Ltd., Hamilton, Ont. *Advt. 151.*  
Peterboro Lock Mfg Co. Peterboro, Ont. *Advt. 219.*  
Smart (James) Mfg Co., Brockville, Ont. *Advt. p. 178.*

**3308—STOPS—(Iron) Rough Water Works.**

Kerr Engine Co. Walkerville, Ont. *Advt. page 208.*  
Stevens Mfg Co., London, Ont.  
Macdonald & Co. Ltd., Halifax, N.S. *Advt. page 256.*  
Garth & Co., Montreal, Que. *Advt. page 154.*  
Mitchell, Robert & Co., Montreal, Que. *Advt. p. 213.*

**3309—STOPS—(Wood) Door, Sliding Door.**

Edwards, W. C. & Co., Ottawa, Ont. *Advt. p. 219.*  
Wesley, F. J. & Co., Toronto Junction, Ont.  
Otterville Mfg Co. Ltd., Otterville, Ont. *Advt. p. 259.*

**3310—STOPS—Corporation, Steam.**

Morrison, Jas. Brass Mfg Co., Toronto, Ont. *Advt. 157.*  
McAvity, T. & Sons, St. John, N. B. *Advt. p. 153.*  
Mitchell, Rob't & Co., Montreal, Que. *Advt. p. 213.*

**3311—STOVES—Toy.**

Ives, H. R. & Co., Montreal, Que. *Advt. page 200.*  
Smart, (Jas.) Mfg Co., Brockville, Ont. *Advt. p. 178.*

**3312—STOVES—Open Grate.**

Gurney, Tilden Co. Ltd., Hamilton, Ont. *Advt. 151.*  
Gurney Foundry Co. Ltd., Toronto, Ont.  
Carrier, Laine & Co., Levis, Que. *Advt. page 150.*  
Ives, H. R. & Co., Montreal, Que. *Advt. page 200.*

**3313—STOVES—(Sheet Iron) Camp.**

Carrier, Laine & Co., Levis, Que. *Advt. page 150.*  
Davidson Mfg Co. (Thos), Montreal, Que. *Advt. 225.*

**3314—STOVES—(Iron & Sheet Iron Gas, Oil.**

Bigley, R., Toronto, Ont. *Advt. page 242.*  
Gurney Foundry Co. Ltd., Toronto, Ont.  
Kemp Mfg Co., Toronto, Ont.

**3315—STOVES & RANGES—(Special Favorites) "Champion", "Domestic", "Souvenir Base Burner", "Avon Souvenir", "Cottage Souvenir", "Home Souvenir", "Ranges", "Maple Souvenir", "Original & Bright Idea", "Cornet Book".**

Gurney, Tilden Co. Ltd., Hamilton, Ont. *Advt. 151.*

**3316—STOVES—(Cast Iron) Farmers' Box, Wood, Coal, Stove Parts, Dairy, Cooking, Car, Parlor.**

Gurney, Tilden Co., Hamilton, Ont. *Advt. page 151.*  
Carrier, Laine & Co., Levis, Que. *Advt. page 150.*  
Smart (James) Mfg Co., Brockville, Ont. *Advt. 178.*  
Ives, H. R. & Co., Montreal, Que. *Advt. page 200.*  
Clare Bros. & Co., Preston, Ont. *Advt. page 243.*  
Gurney Foundry Co., Toronto, Ont.

Stewart (Jas.) Mfg Co. Ltd., Woodstock, Ont.  
Burrow, Stewart & Milne, Hamilton, Ont.  
Crossman & Laws, Amherst, N.S. *Advt. page 226.*  
Entreprise Foundry Co. (The), Sackville, N.B.  
Windsor Foundry Co., Windsor, N.S.  
Truro Foundry & Machine Co., Truro, N.S. *Advt. 198.*  
Milton Foundry Co., Yarmouth, N.S.,  
Record Foundry Co., Moncton, N.B.  
Burrell-Johnson Iron Co., Yarmouth, N.S.

**3317—STRAINERS—(Wire Cloth) Cup, Coffee, Tea, Milk Pail, Wine.**

Davidson Mfg Co. Ltd. (Thos.), Montreal. *Advt. p. 225.*  
Kemp Mfg Co., Toronto, Ont.  
Chown, W. W. & Co., Belleville, Ont. *Advt. p. 233.*

**3318—STRAINERS—Brass, Faucet.**

Garth & Co., Montreal, Que. *Advt. page 154.*

**3319—STRAND—(For Terra Cotta Work).**

Dominion Wire Rope Co. Ltd., Montreal. *Advt. p. 171.*

**3320—STRAPS—Street Car Bell (Brass).**

Peterboro Lock Mfg Co., Peterboro, Ont. *Advt. 219.*

**3321—STRAPS—Carriage Curtain.**

McKinnon Dash & Hardware Co., St. Catharines, Ont. *Advt. page 202.*

**3322—STRAPS—Pipe.**

Young & Bro. Co. Ltd., Hamilton, Ont. *Advt. 257.*

**3323—STRAPS—Block.**

Bradley Bros., St. John, N. B.

**3324—STRAPS—Deckle.**

Canadian Rubber Co., Montreal, Que. *Advt. p. 197.*

**3325—STRAINERS—Faucet, Iron Pipe, Water Conductor.**

Macdonald & Co. Ltd., Halifax, N. S. *Advt. p. 256.*  
McAvity, T. & Sons, St. John, N. B. *Advt. page 153.*  
Dennis Wire & Iron Works, London, Ont. *Advt. 207.*  
Kerr Engine Co. Ltd., Walkerville, Ont. *Advt. 208.*

**3326—STRAPS—Harness (Textile) Loom.**

Frind, (Paul) Woolen Machinery Co. Ltd., Toronto, Ont. *Advt. page 249.*

**3327—STRETCHERS—Saw.**

Ballantine, John & Co., Preston, Ont. *Advt. p. 205.*

**3328—STRETCHERS—Cloth.**

Goldie & McCulluch Co. Ltd., Galt, Ont. *Advt. p. 159.*

**3329—STRETCHERS—(Meggs Pat.) Carpet.**

St. Lawrence Steel & Wire Co. Ltd., Gananoque, Ont. *Advt. page 183.*

**3330—STRETCHERS—Wire.**

Ontario Lead & Barb Wire Co. Ltd., Toronto, Ont. *Advt. page 177.*

Dominion Wire Mfg Co., Montreal, Que. *Advt. p. 176.*  
Ives, H. R. & Co., Montreal, Que. *Advt. page 200.*  
Safety Barb Wire Co. Ltd., Toronto, Ont. *Advt. 180.*  
Otterville Mfg Co., Otterville, Ont. *Advt. page 259.*

**3331—STRETCHERS—Artists'**

Woltz & McMahon, Toronto, Ont. *Advt. page 203.*

**3332—STRETCHERS—Belt.**

Goodhue, J. I. & Co., Danville, Que. *Advt. page 236.*  
Robin, Sadler & Haworth, Montreal, Que. *Advt. 226.*

**3333—STROPS—Razor.**

Hemming Bros. Co. Ltd., Toronto, Ont.

**3334—STUDS—Iron.**

Gillies, Geo. Co., (The) Gananoque, Ont. *Advt. page 156.*

**3335—STUDS—(Brass) Shoe.**

Parmenter & Bullock, Gananoque, Ont. *Advt. p. 199.*

**3336—STUDS—Shirt Rolled Gold. See No. 1866.****3336a—STRAIGHTNER—Axle.**

Jardine, A. B. & Co., Hespeler, Ont. *Advt. page 217.*

**3337—STUFFERS—Sausage.**

Ives, H. R. & Co., Montreal, Que. *Advt. page 200.*  
Smart (Jas.) Mfg Co., Brockville, Ont. *Advt. p. 178.*

**3338—SUGAR—Maple.**

Palmer, J. S., Sherbrooke, Que. *Advt. page 228.*  
Toronto Biscuit & Confectionery Co., Toronto, Ont.  
McCormick Mfg Co. Ltd., London, Ont.  
Clough, A. G., Ayers Flats, Que.  
Spofford, F., Stouffville, Ont.

**3339—SUGAR—(Cane) Granulated, Pulverised, Loaf, Lump, "Syrups".**

Acadia Sugar Refining Co. Ltd., Halifax, N.S.  
Canada Sugar Refining Co., Montreal, Que.  
St. Lawrence Sugar Refining Co., Montreal, Que.  
British Columbia Sugar Refining Co., Vancouver, B.C.

**3340—SUGARS—Beet.**

Lefebvre, Michel & Co., Berthierville, Que.

**3341—SUITINGS—Worsted, Woolen.**

Forbes Co. Ltd. (The R.), Hespeler, Ont.  
Rosamond Woolen Co., Almonte, Ont.  
Gillies, Son & Co., Carleton Place, Ont.  
Cornwall Mfg Co., Cornwall, Ont.  
Caldwell, Boyd & Co., Lanark, Ont.  
Grindrod, A. L. & Co., Sherbrooke, Que.  
Globe Woolen Mills Co., Montreal, Que.  
Auburn Woolen Co., Peterborough, Ont.  
Paton Mfg Co., Sherbrooke, Que.  
Yarmouth Woolen Mills Co. Ltd., Yarmouth, N.S.

**3342—SWINGS—Automatic, Lawn.**

*See No. 3591.*

**3343—SUITS—(Bathing) Ladies', Gents.**

Watson Mfg Co. Ltd. (The), St. Catharines, Ont.  
Schofield Woolen Co., Oshawa, Ont.

**3344—SUITS—Matted Parlor.**

Gendron Mfg Co. Ltd., Toronto, Ont. *Advt. p. 187.*  
American Rattan Co., Toronto, Ont.

**3345—SULKIES—Boys', Dog & Goat.**

Gendron Mfg Co. Ltd., Toronto, Ont. *Advt. p. 187.*

**3346—SULKYS—Trotting (Pneumatic Tire).**

Goold Bicycle Co. Ltd., Brantford, Ont. *Advt. p. 220.*

**3347—SULPHATE OF COPPER—Sodium.**

Canada Chemical Mfg Co. Ltd., London, Ont.  
Lyman Bros & Co. Ltd., Toronto, Ont.

**3348—SULPHUR.**

Canada Chemical Mfg Co. Ltd., London, Ont.

**3349—SUPPORTS—(Window) Sash.**

Cooke Hardware Co., Hamilton, Ont. *Advt. p. 166.*

**3350—SUPPOSITORIES—Glycerine.**

Parke, Davis & Co., Walkerville, Ont.

**3351—SURFACERS—Emery.**

Prescott Emery Wheel Co., Prescott, Ont. *Advt. 237.*  
Hart Emery Wheel Co., Hamilton, Ont. *Advt. 166.*

**3352—SUBSTRUCTURE—Monolithic.**

Central Bridge & Engineering Co. Ltd., Peterboro, Ont. *Advt. page 214.*

**3353—SULPHATE OF COPPER—Iron & Ammonium, Sodium, Zinc.**

Lyman, Bros. & Co. Ltd., Toronto, Ont.

**3354—SULPHIDE OF IRON.**

Lyman, Bros. & Co. Ltd., Toronto, Ont.

**3354a—SUPPLIES—Electrical.**

Packard Electric Co., St. Catharines, Ont. *Advt. 239.*  
Starr, Jno. Son & Co., Halifax, N.S. *Advt. page 222.*  
Canadian Electric Construction & Supply Co.  
Montreal, Que.  
Toronto Electrical Works, Toronto, Ont.  
Royal Electric Co., Montreal, Que.

**3355—SUNSHADES—Ladies', Children's.**

Irving & Co., Toronto, Ont.

**3356—SUPPORTERS—Thill, Shaft, Anti-Rattler (Vehicle). See No. 2751.****3357—SUPPORTERS—(Elastic) Sleeve, Skirt, Stocking.**

Vroom, C. N., St. Stephen, N.B. *Advt. page 257.*  
Globe Suspender Co., Rock Island, Que.  
Dominion Suspender Co., Niagara Falls, Ont.  
Wilmot Corset Co., South Farmington, N.S.  
Glassford Bros. & Pollock, Montreal, Que.

**3358—SUPPORTERS—Abdominal, Spinal.**

Authors & Cox, Toronto, Ont.  
Gross, F., Montreal, Que.  
Cluthe, Charles, Toronto, Ont.

**3359—SUSPENDERS—"Excelsior".**

Stouffer, J. R. Co. (The), Berlin, Ont. *Advt. p. 185.*

**3360—SUSPENDERS—"Chester & Workers."**

Hall, James & Co., Brockville, Ont. *Advt. page 227.*

**3361—SUSPENDERS—Elastic, Non-Elastic.**

Hall, James & Co., Brockville, Ont. *Advt. page 227.*  
Stouffer, J. R. Co. (The), Berlin, Ont. *Advt. page 185.*  
Vroom, C. N., St. Stephen, N. B. *Advt. page 257.*  
Montreal Suspender & Umbrella Mfg Co. (The),  
Montreal, Que.  
Globe Suspender Co., Rock Island, Que.

**3362—SWAGES—(Saw) Hand, Automatic, Power.**

Ballantine, John & Co., Preston, Ont. *Advt. p. 205.*  
Butterfield & Co., Rock Island, Que.

**3363—SWEATERS—Sportmen's Woolen.**

Watson Mfg Co. Ltd. (The), St. Catharines, Ont.

**3364—SWEDGE—Square Pan, Callender, Creasing, Elbow. See No. 2125.**

**3365—SWEDGES—(Blacksmiths') Top, Button.**

Whitman & Barnes Mfg Co., St. Catharines, Ont.

**3366—SWEEPERS—(Rotary) Street, Snow, Ry. Track.**

Speight Wagon Co., Markham, Ont. *Advt. p. 245.*  
Crossen Car Mfg Co. Ltd., Cobourg, Ont.  
Ottawa Car Co'y. Ltd. (The), Ottawa, Ont.

**3367—SWEEPERS—Carpet.**

Otterville Mfg Co. Ltd., Otterville, Ont. *Advt. p. 259.*  
Bissell Carpet Sweeper Co., Toronto, Ont.

**3368—SWITCHES—Hair.**

Dorenwend Co. Ltd., (The), Toronto, Ont.  
Palmer's, Montreal, Que.

**3369—SWITCHES—(Over Head Track) Packing House.**

Macdonald, J. K., Montreal, Que. *Advt. page 247.*

**3370—SWITCHES — (Electrical) Battery, Snap, Telegraph, Telephone, Jack Knife, Motor, Cut Out, Over Head.**

Ingersoll Rock Drill Co., Montreal, Que. *Advt. 198.*  
Kay Electric Works, Hamilton, Ont. *Advt. page 233.*  
Ness, McLaren & Bate, Montreal, Que. *Advt. p. 240.*

**3371—SWITCHES—Ry. Track, Interlocking, Automatic, Portable, Signaling, Split, Mine Track.**

Canada Spring & Switch Co., Montreal, Que. *Advt. 217*  
Stewart, John, New Glasgow, N.S. *Advt. page 222.*  
Central Bridge & Engineering Co., Peterboro, Ont.  
*Advt. page 214.*  
Brown (G. & J.) Mfg Co., Belleville, Ont. *Advt. 198.*

**3372—SWITCHES—Railway (Ramapo Patent).**

Central Bridge & Engineering Co., Peterboro, Ont.  
*Advt. page 214.*

**3373—SWIVELS—Iron & Steel.**

Dominion Bridge Co., Montreal, Que. *Advt. p. 195.*

**3374—SWIVELS—Jewelry. See No. 757.**

**3375—SYRINGES—Garden (Brass). S. No. 2691**

**3376—SYRINGES—Glass.**

Lamont Glass Works, New Glasgow, N.S. *Advt. 231.*  
Dominion Glass Works, Montreal, Que. *Advt. p. 221.*

**3377—SYRINGES — Eye & Ear, Fountain, Hypodermic.**

Cluthe, Chas., Toronto, Ont.

**3378—SYRINGES—Rubber, Bulb. See No. 2869.**

**3379—SYRUP—Glucose. See No. 3339.**

**3380—SYRUP—Maple.**

Palmer, J. S., Sherbrooke, Que. *Advt. page 228.*  
Toronto Biscuit & Confectionery Co., Toronto, Ont.

**3381—SYRUPS—Sorghum.**

Lefebvre, Michel, Berthierville, Que.

**3382—SYRUPS—Fruit.**

Pure Gold Mfg Co., Toronto, Ont.

Turner, Robert, Toronto, Ont.

Gurd, Chas. & Co., Montreal, Que. *Advt. page 235.*

Brown & Webb, Halifax, N.S.

Jonas, Henri & Co., Montreal, Que.

Rowe, Frank & Co., Montreal, Que. *Advt. page 235.*

**3383—SYRUPS—Medicinal.**

Parke, Davis & Co., Walkerville, Ont.

Stearns, Fred'k & Co., Windsor, Ont. *See back cover.*

**3384—SYRUPS—Trifoleum, Compound, Yerberba, Santa Aromat, Iron Chloride (Weld's).**

Parke, Davis & Co., Walkerville, Ont.

**3385—SYRUPS—Cough.**

Lyman, Sons & Co., Montreal, Que.

Kerry, Watson & Co., Montreal, Que.

**3386—TABLES—(Turn), Tramway, Railway, Mine Car, Locomotive, Steel, Portable.**

Jenckes Machine Co., Sherbrooke, Que. *Advt. p. 165.*

Rathbun Co. (The), Deseronto, Ont. *Advt. page 162.*

Brown, (G. & J.) Mfg Co., Belleville, Ont. *Advt. 198.*

Loignon, A. & E., Montreal, Que. *Advt. page 247.*

Dominion Bridge Co. Ltd., Montreal, Que. *Advt. 195.*

Canadian Locomotive & Engine Co. Ltd., Kingston, Ont. *Advt. page 175.*

Central Bridge & Engineering Co., Peterboro, Ont.

*Advt. page 214.*

Mathison, I. & Co., New Glasgow, N. S., *Advt. 200.*

Rhodes, Curry & Co., Amherst, N. S. *Advt. p. 158.*

**3387—TABLES—Folding Camp.**

Dominion Snath Co., Waterville, Que. *Advt. p. 241.*

**3388—TABLES—Wicker.**

Pelosse, P., Montreal, Que. *Advt. page 234.*

**3389—TABLES—Billiard, Pool, Pigeon Hole.**

Reid Bros. Mfg Co. of Toronto Ltd., Toronto, Ont.

May, Samuel & Co., Toronto, Ont.

Ethier, E. L. & Co., Montreal, Que.

Nightingale, D., Montreal, Que.

**3390—TABLES—(Saw) Automatic, Cut-up.**

Mayo, W. S., Ottawa, Ont. *Advt. page 205.*

**3391—TABLES—(Folding) Work.**

Otterville Mfg Co. Ltd., Otterville, Ont. *Advt. p. 259.*

**3392—TABLES—Brass.**

Hamilton Brass Mfg Co., Hamilton, Ont. *Advt. 168.*

Chadwick Bros., Hamilton, Ont. *Advt. page 206.*

**3393—TABLES—Oak, Enamelled, White.**

Thompson, Alex. & Co., Hamilton, Ont.

**3394—TABLES—(Iron) Saw.**

Bateman, William & Co., Montreal, Que. *Advt. 247.*

Ontario Wind Engine & Pump Co., Toronto, Ont.

*Advt. page 244.*

**3395—TABLES—(Steam) Hotel, Restaurant, Copper.**

Garth & Co., Montreal, Que. *Advt. page 154.*

Booth Copper Co., Toronto, Ont. *Advt. page 155.*

Parker, J. O. & Co., Toronto, Ont. *Advt. page 253.*

Coulter & Campbell, Toronto, Ont. *Advt. page 201.*

American Copper Co., Toronto, Ont. *Advt. page 157.*

Mitchell, Robert & Co., Montreal, Que. *Advt. p. 213.*

Gurney Foundry Co. Ltd., Toronto, Ont.

**3396—TABLES—(Saw) Spool Wood.**

Carrier, Laine & Co., Levis, Que. *Advt. page 150.*

**3397—TABLES—Multiplication.**

Allen, T. C. & Co., Halifax, N.S.

**3398—TABLES—Saw Brazing.**

Ballantine, John & Co., Preston, Ont. *Advt. p. 205.*

**3399—TABLETS—Slate.**

New Rockland Slate Co., Montreal Que. *Advt. 244.*

**3400—TABLETS—Marble.**

Toronto Granite Co. Ltd., Toronto, Ont.

**3401—TABLETS—(Medicinal) Compressed.**

Stearns, Fred'k & Co., Windsor, Ont. *See back cover.*

**3402—TABLETS—(Flavored) Fruit.**

McCormick Mfg Co. Ltd., London, Ont.

**3403—TABLETS—Cough.**

Armstrong & Co., St. John, N. B. *Advt. page 229.*

**3404—TABLETS—Hypo. *See No. 803.***

**3405—TABLETS.**

Parke, Davis & Co., Walkerville, Ont.

**3406—TABLETS—Brass.**

Chadwick Bros., Hamilton, Ont. *Advt. page 206.*

**3407—TABLETS—Memorandum (Paper).**

Gage Co. Ltd. (W. J.), Toronto, Ont. *Advt. p. 189.*  
Brown Bros. Ltd. (The), Toronto, Ont.  
Morton, Phillips & Co., Montreal, Que.

**3408—TACKLE—Chain Hoisting.**

Ingersoll Rock Drill Co., Montreal, Que. *Advt. 198.*  
Mac Machine Co., Belleville, Ont. *Advt. page 194.*  
Jenckes Machine Co., Sherbrooke, Que. *Advt. p. 165.*

**3409—TACKS—Brass, Copper, Wire.**

Ontario Tack Co. (The), Hamilton, Ont. *Advt. p. 180.*  
Parmenter & Bullock, Gananoque, Ont. *Advt. p. 199.*

**3410—TACKS — (Cut) Upholsters, Shoe, Miners', Gimp & Lace, Cheese Box, Basket, Carpet.**

Portland Rolling Mills, St. John, N. B. *Advt. p. 195.*  
Montreal Rolling Mills Co., Montreal, Que. *Advt. 174.*  
Ontario Tack Co. (The), Hamilton, Ont. *Advt. p. 180.*

**3411—TAGS—(Paper) Shipping.**

Wilson, J. C. & Co., Montreal, Que.  
Canada Paper Co. Ltd., Montreal, Que.  
Brown, D. F. & Co., St. John, N. B.

**3412—TAGS—(Dog) Brass, Nickle. *See No. 786.***

**3413—TALLOW. *See Merchants 3858.***

**3414—TANKS—(Cast Iron) Water, Water Closet (Iron Troughs).**

Ives, H. R. & Co., Montreal, Que. *Advt. page 200.*  
Young & Bro. Co. Ltd., Hamilton, Ont. *Advt. p. 257.*  
Garth & Co., Montreal, Que. *Advt. page 154.*  
Carrier, Laine & Co., Levis, Que. *Advt. page 150.*  
McAvity, T. & Sons, St. John, N.B. *Advt. page 153.*

**3415—TANKS — (Wood) Railroad, Water, Bridge, Factory, Wind Mill.**

Edwards, W. C. & Co., Ottawa, Ont. *Advt. page 219.*  
Butcher, F. E., St. Mary's, Ont.  
Plews, D. & Co., Toronto, Ont.  
Lendreville, J., Toronto, Ont.

**3416—TANKS—(Copper) Water, Brewers'.**

Booth Copper Co., Toronto, Ont. *Advt. page 155.*  
Coulter & Campbell, Toronto, Ont. *Advt. page 201.*  
Garth & Co., Montreal, Que. *Advt. page 154.*  
Morrison Brass Mfg Co. (Jas), Toronto, Ont. *Advt. 157.*  
Chadwick Bros., Hamilton, Ont. *Advt. page 206.*  
Parker, J. O. & Co., Toronto, Ont. *Advt. page 253.*

**3417—TANKS—(Boiler Plate) Steam, Cistern, Marine, Water, Ry. Oil, Ship, Sorghum, Slaughter House.**

Carrier, Laine & Co., Levis, Que. *Advt. page 150.*  
Matheson, I. & Co., New Glasgow, N.S. *Advt. 200.*  
Patterson, John, Halifax, N.S. *Advt. page 194.*  
White (W. C.) Boiler Works, Montreal, Que.  
Flemming, James, St. John, N.B.  
Nie & Whitfield, Hamilton, Ont.  
Central Bridge & Engineering Co., Peterbore, Ont. *Advt. page 214.*

Goldie & McCulloch Co., Galt, Ont. *Advt. page 159.*  
Macdonald & Co. Ltd., Halifax, N.S. *Advt. p. 256.*  
Dominion Bridge Co. Ltd., Montreal, Que. *Advt. 195.*  
Jenckes Machine Co., Sherbrooke, Que. *Advt. p. 165.*  
Brown (G. & J.) Mfg Co., Belleville, Ont. *Advt. 198.*

**3418—TANKS—(Tin) Grocers' Oil.**

Chown, W. W. & Co., Belleville, Ont. *Advt. p. 233.*  
Davidson Mfg Co. (Thos), Montreal, Que. *Advt. 225.*

**3419—TANKS—(on wheels), Asphalt.**

Nie & Whitfield, Hamilton, Ont.

**3420—TANKARDS—(Drinking), Sterling & Plated. *See No. 3092.***

**3421—TORPEDOS—Track.**

Dominion Cartridge Co., Montreal, Que. *Advt. 196.*  
Acadia Powder Co., Halifax, N.S. *Advt. page 240.*

**3422—TAPE—(Electric), Rubber.**

Toronto Rubber Co. Ltd. (The), Toronto, Ont.

**3423—TAPERS—Wax.**

Imperial Oil Co., Petrolia, Ont. *Advt. page 230.*  
Molleur, J. E., St. Johns, Que.

**3424—TAPES—(Cotton), Skirt, Shirt.**

Hamilton Cotton Co., Hamilton, Ont. *Advt. p. 188.*

**3425—TAPS—Pipe.**

Ives, H. R. & Co., Montreal, Que. *Advt. page 200.*

**3426—TAPS—Shoe. *See No. 3277.***

**3427—TAPS—(Brass), Ale.**

Mitchell, Rob't & Co., Montreal, Que. *Advt. p. 213.*

**3428—THRESHERS—Bean. *See No. 2077.***

**3429—TAPS—(Steel), Machine, Boiler Makers', Expansion, Taper, "Taps & Dies".**

Goldie & McCullough Co., Galt, Ont. *Advt. p. 159.*  
Jardine, A. B. & Co., Hespeler, Ont. *Advt. p. 217.*  
Bertram, John & Sons, Dundas, Ont. *Advt. p. 161.*



- Canada Screw Co., Hamilton, Ont. *Advt. page 226.*  
Butterfield & Co., Rock Island, Que.
- 3430—TAPS—Blacksmiths', Stay Bolt, Drill.**  
Jardine, A. B. & Co., Hespeler, Ont. *Advt. page 217.*  
Butterfield & Co., Rock Island, Que.
- 3431—TAPS—Wood.** *See Spiles No. 3175.*
- 3432—TAR—Wood.**  
Rathbun Co. (The), Deseronto, Ont. *Advt. page 162.*
- 3433—TARPAULINS—Oiled Duck.**  
Montreal Tent Awning & Tarpaulin Co., Montreal, Que. *Advt. page 232.*  
Pike, D., Toronto, Ont. *Advt. page 182.*  
Sonne, Thomas, Montreal, Que.  
Canadian Oiled Clothing Co. Ltd., Port Hope, Ont.  
Morris, J. W., Montreal, Que.  
Shirley, John K., Calgary, Alberta.
- 3434—TARPAULINS—Rubber.**  
Toronto Rubber Co. Ltd. (The), Toronto, Ont.
- 3435—TARTAR—Cream.**  
Ewing, S. H. & A. S., Montreal, Que. *Advt. p. 238.*  
Snow Drift Co., Brantford, Ont.  
Dearborn & Co., St. John, N. B.
- 3436—TARTAR EMETIC.** *See No. 803.*
- 3437—TASSELS—Carriage, Silk.**  
White, Allen Co. Ltd., (The) Toronto, Ont.  
Moulton & Co., Montreal, Que.
- 3438—TEES—(Pipe) Branch, Suction, Steel.**  
Drummond, McCall & Co., Montreal, Que. *Advt. 206.*  
Canada Pipe Foundry Co., Hamilton, Ont.  
Central Bridge & Engineering Co. Ltd., Peterboro, Ont. *Advt. page 214.*
- 3439—TEETH—Hand Rake.**  
Bushlin, S., Port Elgin, Ont.  
Still, J. H., St. Thomas, Ont.
- 3440—TEETH—Threshing Machine.**  
Swansea Forging Co., Swansea, Ont. *Advt. p. 156.*  
Whitman & Barnes Mfg Co., St. Catharines, Ont.
- 3441—TEETH — (Steel) Cultivator, Rake, Harrow.**  
Chalifoux, O & Sons, St. Hyacinthe, Que. *Advt. 232.*  
Nova Scotia Steel Co. Ltd., New Glasgow, N. S.  
Steel Harrow Co., New Glasgow, N. S.  
Whitman & Barnes Mfg Co. St. Catharines, Ont.
- 3442—TEDDERS—Hay.**  
Maxwell, David & Sons, St. Marys, Ont. *Advt. p. 250.*
- 3443—TELEGRAPHS—Ship.**  
Morrison, Jas. Brass Mfg Co. Ltd., Toronto, Ont. *Advt. page 157.*
- 3444—TELEPHONES—Long Distance, Flag-neto, Warehouse.**  
Ness, McLaren & Bate, Montreal, Que. *Advt. p. 240.*  
Bell Telephone Co. (The), Montreal, Que.  
Starr, John Son & Co., Halifax, N. S.
- 3445—TELESCOPES—Surveyors, Micrometer, Astronomical.**  
Foster, James, Toronto, Ont.

- 3446—TEMPLES—Loom, Woolen Mill.**  
Karch, H. W., Hespeler, Ont.  
Paul, Frind Woolen Machinery Co. Ltd., Toronto, Ont. *Advt. page 249.*
- 3447—TENONERS—Sash, Door & Blind.**  
*See No. 2072.*
- 3448—TENTS—Army, Camp, Lawn.**  
*See Sails No. 2888.*
- 3449—TERRA COTTA—Architectural, Construction, Plain, Porous.**  
Beamsville Pressed Brick Co., Beamsville, Ont. *Advt. page 215.*  
Rathbun Co. (The), Deseronto, Ont. *Advt. p. 162.*  
Montreal Terra Cotta & Lumber Co. Montreal, Que. *Advt. page 214.*
- 3450—TEREBENE.**  
Parke, Davis & Co., Walkerville, Ont.
- 3451—TERRETS & HOOKS—(Harness).**  
Smart, (Jas.) Mfg Co., Brockville, Ont. *Advt. p. 178.*  
Parmenter & Bulloch, Gananoque, Ont. *Advt. p. 199.*  
Gillies, Geo. (The) Co., Gananoque, Ont. *Advt. p. 156.*  
Kyle, P., Merrickville, Ont.  
Burrow, Stewart & Milne, Hamilton, Ont.  
Skinner & Co., Gananoque, Ont. *Advt. page 255.*
- 3452—TESTERS—(Farmers'), Milk.**  
Macpherson, D. M., Lancaster, Ont.  
Pearce, John & Co., London, Ont.  
Richardson & Webster, St. Marys, Ont.
- 3453—THERMOSTATS—Incubator, Heat Regulating, Fire Alarm.**  
Toronto Electrical Works, Toronto, Ont.
- 3454—THIMBLES—(Cast Iron) Pipe, Stove Pipe, Extension.**  
Young & Bro. Co. Ltd., Hamilton, Ont. *Advt. 257.*  
Smart (Jas) Mfg Co., Brockville, Ont. *Advt. p. 178.*  
Ives, H. R. & Co., Montreal, Que. *Advt. page 200.*
- 3455—THIMBLES—Asbestos Pipe, Asbestos Packed.**  
Collins Mfg Co., Toronto, Ont.
- 3456—THIMBLES—Stove Pipe, (Porus Tin).**  
Davidson Mfg Co. (Thos), Montreal, Que. *Advt. 225.*  
Gurney, Tilden Co., Hamilton, Ont. *Advt. page 151.*  
Collins Mfg Co., Toronto, Ont.  
Kemp Mfg Co., Toronto, Ont.
- 3457—THIMBLES—Rubber.** *See No. 2869.*
- 3458—THIMBLES—Silver.**  
Ellis, P. W. & Co., Toronto, Ont.
- 3459—THREADERS—Bolt, Pipe.** *See No. 3429.*
- 3460—THREADS—Iron Stair.** *See No. 2524.*
- 3461—THRESHERS—Grain, Clover, Separators.** *See No. 2077.*
- 3462—TICKINGS—Cotton.**  
Parks, Wm. & Son, St. John, N.B. *Advt. page 233.*  
Canadian Colored Cotton Mills Co., Montreal, Que. *Advt. page 181.*
- 3463—THYROIDS.**  
Park, Davis & Co., Walkerville, Ont.

**3464—TIES—(Lath & Shingle) Tarred.**

Kingston Cordage Co., Kingston, Ont.  
 Consumers Cordage Co., Montreal, Que.  
 Anderson, Robert, St. John, N.B.

**3465—TIES—(Wire) Bale.**

Pender, James & Co. Ltd., St. John, N.B. *Advt.* 208.

**3466—TIES—Railway.**

Rhodes, Curry & Co., Amherst, N. S. *Advt.* p. 158.  
 Edwards, W. C. & Co. Ltd., Ottawa, Ont. *Advt.* 219.  
 Rathbun Co. (The), Deseronto, Ont. *Advt.* page 162.  
 Pembroke Lumber Co., Pembroke, Ont. *Advt.* 216.  
 Dickson Co. (The), Peterboro, Ont. *Advt.* page 250.  
 King Bros., Quebec, Que. *Advt.* page 240.  
 Price, H. M. & Co., Quebec, Que. *Advt.* page 223.  
 Cargill, H. & Son, Cargill, Ont.  
 Deutschmann, Fred., Teeswater, Ont. *Advt.* page 218.  
 Playfair, Jas. & Co., Midland, Ont. *Advt.* page 223.  
 Schell, Macpherson & Co., Sayabec, Que.  
 Gilmour, & Co., Trenton, Ont.  
 Sumner Co., Moncton, N. B.  
 Ottawa Lumber Co. (The), Calumet, Que.  
 Cookshire Mills Co., Cookshire, Que.  
 Breakey, John, Chaudiere Mills, Que.  
 Hodge & Walley, Sherbrooke, Que.  
 Goodhue Bros., Danville, Que.  
 McRae Bros. & Co., Ottawa, Ont.  
 Fish, R. Y., Waterloo, Ont.  
 Witthun, C. H. & Co., Hepworth, Ont.  
 Smith, W. E., Lennoxville, Que.  
 Smith, J. F., Tara, Ont.  
 Victoria Harbor Lumber Co., Victoria Harbor, Ont.  
 Buchanan, J. A., Comber, Ont.  
 Holmes, Moore & Courtright, Inwood, Ont.  
 Beaudoin, Thomas, Broughton, Que.  
 Parker & Bishop, Marbleton, Que.  
 Seaman & Newman, Wiarton, Ont.  
 Church, Mitchell & Fee, Mitchell Station, Que.  
 Leonard & Morin, Garthly, Que.  
 Leigh, J. & Sons, Victoria, B. C.  
 Tangua, Chas., Weeden, Que.  
 Tangua, N. P., Weeden, Que.  
 Thompson & Avery, Sharbot Lake, Ont.  
 Kidd, John, Wiarton, Ont.  
 Leonard, M., Wickham West, Que.  
 Morgan, J. D., Dundalk, Ont.  
 Young, William, Wiarton, Ont.  
 Merick, S. S., Carleton Place, Ont.  
 Brunette Saw Mill Co. Ltd., New Westminster, B. C.  
 Tourville Lumber Mills Co. (The), Montreal, Que.  
 Sadler, Dundas & Flavelle Milling Co. Lindsay, Ont.  
 Ray & Robinson, St. Cyrille, Que.  
 McLachlin Bros., Arnprior, Ont.  
 Clough, A. G., Ayers Flats, Que.  
 Comtois & Co., Drummondville, Que.  
 Drummondville Lumber Co., Forestdale, Que.  
 Allen, I., Mississippi Station, Ont.

**3467—TIES—Back Stay, Carriage.**

Swansea Forging Co. Ltd., Swansea, Ont. *Advt.* 156.

**3467a—TIES—Wall.**

Mac Machine Co., Belleville, Ont. *Advt.* page 194.

**3468.—TIGHTENERS—Wire Fence.**

Scott, E. M., Ingersoll, Ont.  
 Otterville Mfg Co. Ltd., Otterville, Ont. *Advt.* 259.

**3469—TIGHTENERS—Guy.**

Mac Machine Co., Belleville, Ont. *Advt.* page 194.  
 Dobbie & Stuart, Thorold, Ont.

**3470—TIGHTENERS—Belt.**

Robin, Sadler & Haworth, Montreal, Que. *Advt.* 226.  
 Robb Engineering Co. Ltd., Amherst, N.S.  
*See inside front cover.*  
 Hamilton Mfg Co. (Wm), Peterboro, Ont.

**3471—TIGHTS—Equestrian.**

Montreal Silk Mill Co., Montreal, Que.  
 Turnbull, C. Co. Ltd., Galt, Ont.

**3472—TILE—Concrete.**

Anthistle, W. J., London, Ont.

**3473—TILE—Enamelled, Glazed.**

Burns & Co., Halifax, N.S.

**3474—TILES—(Stone) Floor.**

Canadian Granite Co. Ltd., Ottawa, Ont.

**3475—TILES—Encaustic.**

Rathbun Co. (The), Deseronto, Ont. *Advt.* page 162.

**3476—TILES—(Slate) Floor.**

New Rockland Slate Co., Montreal, Que. *Advt.* 244.  
 Danville Asbestos & Slate Co., Danville, Que.

**3477—TILES—Art, Open Hearth.**

Campbell, R., Hamilton, Ont. *Advt.* page 230.

**3478—TILES—(Sheet Iron) Roofing, Metallic, Plain, Ornamental. See No. 2856.****3479—TILES—(Clay) Agricultural, Drain & Floor, Vitrified, Terra Cotta.**

Rathbun Co. (The), Deseronto, Ont. *Advt.* page 162.  
 Beamsville Pressed Brick Co., Beamsville, Ont.  
*Advt.* page 215.  
 Montreal Terra Cotta & Lumber Co., Montreal, Que.  
*Advt.* page 214.

**3480—TILLS—Alarm.**

Gurney Scale Co., Hamilton, Ont. *Advt.* page 244.

**3481—TIMBER—Limits.**

Palmer, J. S., Sherbrooke, Que. *Advt.* page 228.

**3482—TIMBER—Bridg, Dimension.**

Rathbun Co. (The), Deseronto, Ont. *Advt.* page 162.  
 Rhodes, Curry & Co. Ltd., Amherst, N.S. *Advt.* 158.  
 Edwards, W. C. & Co., Ottawa, Ont. *Advt.* page 219.  
 Dickson Co. (The), Peterboro, Ont. *Advt.* page 250.  
 Pembroke Lumber Co., Pembroke, Ont. *Advt.* 216.  
 St. Anthony Lumber Co., Ottawa, Ont. *Advt.* p. 216.  
 Hawkesbury Lumber Co. Ltd., Hawkesbury, Ont.  
 Dickie, Alfred Lower Stewiacke, N.S.  
 Gale, George & Sons, Waterville, Que. *Advt.* p. 258.  
 Playfair, James & Co., Midland, Ont. *Advt.* p. 223.  
 Chatham Mfg Co., Chatham, Ont. *Advt.* page 245.  
 Cookshire Mills Co., Cookshire, Que.  
 Klock, R. H. & Co., Aylmer, Que.  
 Georgian Bay Lumber Co. Ltd., Waubaushene, Ont.  
 Copping, William, Joliette, Que.  
 Parker & Howe, Dixville, Que.  
 Cargill, H. & Son, Cargill, Ont.  
 Brunette Saw Mill Co., New Westminster, B. C.  
 Barnhill, B. B., Two Rivers, N.S.  
 Bronsons & Weston Lumber Co. Ltd., Ottawa, Ont.  
 Cutler & Savidge Lumber Co., Kenabutch, Ont.  
 Canada Lumber Co. Ltd., Carleton, Place, Ont.  
 Cushing, André & Co., St. John, N.B.  
 Gilmour & Co., Trenton, Ont.  
 Henderson Bros., Montreal, Que.

- Imperial Lumber Co. Ltd., Toronto, Ont.  
 Kelley Bros., River Hebert, N.S.  
 Beck, C. Mfg Co. Ltd., Penetanguishene, Ont.  
 Leigh, J. & Sons, Victoria, B.C.  
 McLachlin Bros., Arnprior, Ont.  
 Mason, Wm. & Sons, Ottawa, Ont.  
 Maitland, Rixon & Co., Owen Sound, Ont.  
 Pickard & Rowan, Owen Sound, Ont.  
 Parker & Bishop, Marbleton, Que.  
 Stetson, Cutler & Co., St. John, N.B.  
 Sadler, Dundas & Flavell Milling Co., Lindsay, Ont.  
 Thompson & Avery, Sharbot Lake, Ont.  
 Victoria Harbor Lumber Co., Victoria Harbor, Ont.  
 Warner, James R. & Co., St. John, N.B.  
 Witthun, C. H. & Co., Hepworth, Ont.  
 White, A. & P., Pembroke, Ont.  
 White, E. T. & Son, Sand River, N.S.  
 White, C. T., Apple River, N.S.
- 3483—TIN—Feathered & Bar.**  
 Canada Chemical Mfg Co. Ltd., London, Ont.
- 3484—TIN—Crystals, (Oximariate of).**  
 Montreal Chemical Works, Montreal, Que.
- 3485—TINS—Lithographed, Tinware, Lithographed, Decorated.**  
 Macdonald Mfg Co., Toronto, Ont.
- 3486—TINWARE—Pressed, Pieced, Stamped, Heavy, Embossed, Japanned.**  
 Chown, W. W. & Co., Belleville, Ont. *Advt. p. 233.*  
 Davidson Mfg Co. Ltd. (The Thos.), Montreal Que. *Advt. page 225.*  
 Kemp Mfg Co., Toronto, Ont.  
 Collins Mfg Co., Toronto, Ont.
- 3487—TINCTURES.**  
 Lyman Bros. & Co. Ltd., Toronto, Ont.  
 Stearns, Fred'k & Co., Windsor, Ont. *See back cover.*
- 3488—TINCTURES—(Warburg's).**  
 Parke, Davis & Co., Walkerville, Ont.
- 3489—TIPS—Pole & Thill, Neck Yoke, Shaft,**  
 Swansea Forging Co. Ltd., Swansea, Ont. *Advt. 156.*  
 Frost, W. H., Smith's Falls, Ont.
- 3490—TIPS — (Rubber) Chair, Furniture Crutch.**  
 Canadian Rubber Co., Montreal, Que. *Advt. p. 197.*  
 Toronto Rubber Co. Ltd. (The), Toronto, Ont.
- 3490a—TIPS—Syringe & Finger.** *See No. 2869.*
- 3491—TIRES—(Rubber) Solid, Pneumatic.**  
 Canadian Rubber Co., Montreal, Que. *Advt. p. 197.*
- 3492—TIRES—Steel.**  
 Abbott & Co., Montreal, Que. *Advt. page 196.*  
 Montreal Rolling Mills Co., Montreal, Que. *Advt. 174.*
- 3493—TISSUE—Gutta Percha.**  
 Toronto Rubber Co. Ltd. (The), Toronto, Ont.
- 3494—TOASTERS—Wire.**  
 Meadows, George B., Toronto, Ont.
- 3495—TOBACCO—Leaf.**  
 Walker Sons & Co., Walkerville, Ont.  
 Joliette Tobacco Co., Joliette, Que.

**3496—TOBACCO—Chewing, Smoking.**

Smith, A. & Co., London, Ont.  
 Hickey & Nicholson, Charlottetown, P. E. I.  
 Canadian Tobacco Co., Montreal, Que.  
 Empire Tobacco Co., Montreal, Que.  
 McDonald, W. C., Montreal, Que.  
 Joliette Tobacco Co., Joliette, Que.  
 McAlpin Tobacco Co., Toronto, Ont.  
 Riley, T. B., Charlottetown, P. E. I.  
 Tuckett & Son Co. Ltd. (Geo. E.), Hamilton, Ont.  
 Wurtele, E. C., Sorel, Que.  
 Ritchie, D. & Co., Montreal, Que.  
 Larue, J. Jr., Montreal, Que.  
 Houde, B. & Co., Quebec, Que.  
 LeMesurier, John & Son, Quebec, Que.

**3497—TOBOGGANS.** *See No. 1354.*

**3498—TOMBS—Marble.** *See No. 2235.*

**3499—TONGS—Ice, Hoisting.**

Dennis Wire & Iron Works, London, Ont. *Advt. 207.*  
 Smart, (Jas.) Mfg Co., Brockville, Ont. *Advt. p. 178.*  
 Miller Bros. & Toms, Montreal, Que. *Advt. p. 197.*  
 Kerr & Morgan, Montreal, Que. *Advt. page 220.*

**3500—TONGS—(Iron) Coal, Fire.**

Woodyatt, A. R. & Co., Guelph, Ont. *Advt. page 207.*  
 Smart, (Jas.) Mfg Co., Brockville, Ont. *Advt. p. 178.*  
 Ives, H. R. & Co., Montreal, Que. *Advt. page 200.*

**3501—TONGS—(Roofing) Double Seamer.**

Brown, Boggs & Co., Hamilton, Ont. *Advt. page 193.*

**3502—TONGS—Pipe.**

Butterfield & Co., Rock Island, Que.

**3503—TONGUES—Wagon.**

Chatham Mfg Co. Ltd., Chatham, Ont. *Advt. p. 245.*

**3504—TONGUES—Beef, Lamb.** *See No. 2577.*

**3505—TOOLS—Oil Well.**

Mckee & Marwick, Petrolia, Ont.  
 Oil Well Supply Co., Petrolia, Ont.

**3506—TOOLS—Tinner's.** *See No. 2636.*

**3507—TOP—(Soil Pipe) Anti-Freezing.**

Paddon & Nicholson, Montreal, Que. *Advt. p. 253.*

**3508—TOPS—(Wood) Bottle.**

Lewis, J. & Sons, Truro, N.S.

**3509—TOPS — (Slate) Furniture, Mantel, Radiator, Wash Stand, Butcher's Counter.** *See No. 3115.*

**3510—TOPS — Marble, Mantel, Furniture, Radiator.**

Canadian Granite Co. Ltd., Ottawa, Ont.

**3511—TOPS—(Iron) Metal, Ornamental, Pipe, Chimney, Revolving.**

Young & Bro. Co. Ltd., Hamilton, Ont. *Advt. p. 257.*  
 Garth & Co., Montreal, Que. *Advt. page 154.*  
 Metallic Roofing Co. of Canada, Ltd. (The), Toronto, Ont. *See front fly leaf.*  
 Rodden, Wm. & Co., Montreal, Que.

**3512—TOPS—Cork.**

Cork Co. of Canada, Ltd. (The), Toronto, Ont.

**3513—TOPS—(Canopy) Wagon.**

Dowell, Daniel, Montreal, Que. *Advt. page 203.*

**3514—TOPS—(Leather), Cab, Carriage.**

Dowell, Daniel, Montreal, Que. *Advt. page 203.*  
Rudd, George A. & Co., Brockville, Ont.  
Simpson, I. & Co., Brantford, Ont.  
Guelph Carriage Top Co., Guelph, Ont.  
Conboy, D., Toronto, Ont.

**3515—TOPS—(Salt Glazed), Chimney.**

Standard Drain Pipe Co., St. Johns, Que. *Advt. 251.*  
Beamsville Pressed Brick Co., Beamsville, Ont.  
Glass, Bros. & Co., London, Ont. [*Advt. p. 215.*]

**3516—TORCHES—(Tin), Oil, Alcohol, Gasoline.**

Davidson Mfg Co. (Thos), Montreal, Que. *Advt. 225.*  
Chadwick Bros., Hamilton, Ont. *Advt. page 206.*  
Piper, Noah L. & Son, Toronto, Ont.

**3517—TOW—Carded, Paper Stock, Upholsters'.**

Perine, M. B. & Co., Doon, Ont. *Advt. page 181.*  
Weir & Weir, St. Mary's, Ont.  
Livingstone, J. & J., Baden, Ont.  
Clark & Carman, St. Mary's, Ont.

**3518—TORCHES—Sulphur.**

Parke, Davis & Co., Walkerville, Ont.

**3519—TOWERS—(Steel), Wind Mill**

Ontario Wind Engine & Pump Co. Toronto, Ont. *Advt. page 244.*

**3520—TOYS—Tin.****3521—TOYS—Wood.**

Cosgrove, William, Berlin, Ont.

**3522—TOYS—Iron.**

Ives, H. R. & Co., Montreal, Que. *Advt. page 200.*

**3523—TRACKS—(Iron), Barn Door, Hay Carrier, Overhead.**

Woodyatt, A. R. & Co., Guelph, Ont. *Advt. p. 207.*  
Laing, Ritchie & Co., Essex, Ont. *Advt. page 209.*  
Whitman & Barnes Mfg Co., St. Catharines, Ont.  
Nie & Whitfield, Hamilton, Ont.

**3523 a—TRANSFORMERS—Telephone.**

Packard Electric Co. Ltd. (The), St. Catharines, Ont.

**3524—TRANSETS—Surveyors'. See No. 1806.****3525—TRANSMISSION—Wire Rope.**

Dominion Wire Rope Co. Ltd., Montreal, Que.  
Wilson, James, Merritton, Ont. [*Advt. page 171.*]  
Greening Wire Co. Ltd. (The B.), Hamilton, Ont.

**3526—TRANSMITTERS—Telephone, Transformers.**

Ness, McLaren & Bate, Montreal, Que. *Advt. p. 240.*  
Bell Telephone Co. (The), Montreal, Que.

**3527—TRAPS—Cess Pool. See No. 1831.****3528—TRAPS—Drone Bee. See No. 1724.****3529—TRAPS—(Steam), "Newton's Patent."**

Miller Bros. & Toms, Montreal, Que. *Advt. p. 197.*  
Kerr & Morgan, Montreal, Que. *Advt. page 220.*

**3530—TRAPS—Fly. See No. 3533.****3531—TRAPS—(Ventilator), Anti-Syphoning Back Air.**

Lessard & Harris, Montreal, Que. *Advt. p. 231.*

**3532—TRAPS—(Porcelain), Sanitary.**

Dominion Sanitary Pottery Co., St. Johns, Que. *Advt. page 253.*  
Campbell & Purvis, St. Johns, Que.

**3533—TRAPS—Rat & Mouse, (Iron Wire) Fly.**

Dennis Wire & Iron Works, London, Ont. *Advt. 207.*  
Major Mfg Co., Montreal, Que.  
Meadows, George B., Toronto, Ont.

**3534—TRAPS—(Cast Iron) Pipe), Steam, Sewer Gas, Balance Valve.**

Young & Bro. Co. Ltd., Hamilton, Ont. *Advt. p. 257.*  
Garth & Co., Montreal, Que. *Advt. page 154.*  
Mitchell, Rob't & Co., Montreal, Que. *Advt. p. 213.*  
Morrison, (Jas.) Brass Mfg Co., Toronto. *Advt. 157.*  
Lessard & Harris, Montreal, Que. *Advt. page 231.*  
McAvity, T. & Son, St. John, N. B. *Advt. page 153.*  
Robb Engineering Co. Ltd., Amherst, N. S.

*See inside front cover.*

Smart, (Jas.) Mfg Co., Brockville, Ont. *Advt. p. 178.*  
Carrier, Laine & Co., Levis, Que. *Advt. page 150.*  
Macdonald Mfg Co., Halifax, N. S. *Advt. page 256.*  
McKelvey & Birch, Kingston, Ont. *Advt. page 228.*

**3535—TRAPS—(Lead Pipe), Sink, Water Closet, Sewer.**

Montreal Rolling Mills Co., Montreal, Que. *Advt. 174.*  
Ontario Lead & Barb Wire Co., Toronto, Ont. *Advt. 177.*  
Robertson, (Jas.) Mfg Co. Toronto, Ont. *Advt. p. 167.*  
do do do St. John, N. B. *Advt. p. 167.*  
do do do Winnipeg, Man. *Advt. 167.*  
do do do Montreal, Que. *Advt. p. 167.*  
Lessard & Harris, Montreal, Que. *Advt. page 231.*  
Robertson, Thomas & Co., Montreal, Que.

**2536—TRAYS—(Brass.)**

Booth Copper Co., Toronto, Ont. *Advt. page 155.*  
Coulter & Campbell, Toronto, Ont. *Advt. page 201.*  
American Copper Co., Toronto, Ont. *Advt. p. 157.*  
Chadwick Bros., Hamilton, Ont. *Advt. page 206.*  
Parker, J. O. & Co., Toronto, Ont. *Advt. page 253.*

**3537—TRAYS—(Tin) Child's, Knife, Crumb,**

Davidson Mfg Co. (Thos.), Montreal, Que. *Advt. 225.*  
Kemp Mfg Co., Toronto, Ont.

**3538—TRAYS—Soap.**

Toronto Steel-Clad Bath & Metal Co., Ltd, (The), Toronto, Ont. *Advt. page 155.*

**3539—TRAYS—(Plated) Ash, Table Service, Communion Service. See No. 3092.****3540—TREADS—(Stair), Rubber. See No. 2170.****3541—TREES—Boot & Shoe, (Iron).**

Pettner, B. J., Montreal, Que.  
Lendon, William H., Toronto, Ont.

**3541 a—TREES—(Malleable Iron), Gig, Saddle**

Kyle, P., Merrickville, Ont.

**3542—TRELLISES—Wire.**

Dennis Wire & Iron Works, London, Ont. *Advt. 207.*  
Meadows, George B., Toronto, Ont.

**3543—TRIMMERS—Spoke.**Smart (James) Mfg Co., Brockville, Ont. *Advt. 178.***3544—TRIMMERS—Finger Nail.**

Metallic Novelty Mfg Co. (The), Toronto, Ont.

**3545—TRIMMERS—Cheese Box.**

McPherson, D. M., Lancaster, Ont.

**3546—TRITURATES.**Stearns, Fred'k & Co., Windsor, Ont. *See back cover.***3547—TROUGHES—Metal Eave.**Druvidson Mfg Co., (Thos.), Montreal, Que. *Advt. 225.*  
Douglass Bros., Toronto, Ont. *Advt. page 204.*  
Metallic Roofing Co. of Canada Ltd. *See front fly leaf.***3548—TROUGHES—(Iron), Sectional.***See Tanks No. 3414.***3549—TROUGHES—Oil Drip.**Morrison (Jas.) Brass Mfg Co., Toronto, Ont. *Advt. 157***3550—TROUGHES—(Iron), Grindstone, Swine, Watering.***See No. 3414.***3551—TROWELS—Garden.**Ives, H. R. & Co., Montreal, Que. *Advt. page 200.*  
Smart (Jas.), Mfg Co. Ltd., Brockville, Ont. *Advt. 178.***3552—TROUGHES—Portable, Scalding.**Garth & Co., Montreal, Que. *Advt. page 154.*  
Ives, H. R. & Co., Montreal, Que. *Advt. page 200.*  
Smart (Jas.) Mfg Co., Brockville, Ont. *Advt. p. 178.***3553—TROWELS—Plastering.**Shurley & Dietrich, Galt, Ont.  
Smith, R. H. Co. Ltd., St. Catharines, Ont.**3554—TRUCKS—(Iron Roller), Piano, Stove, Floor, Dry Goods, Platform.***See No. 3560.***3555—TRUCKS—(Hook & Ladder), Fire Department, Extension Ladder, Spiral Ladder.**Smith Bros., Toronto, Ont. *Advt. page 178.*  
Ronald, J. D., Brussels, Ont.**3556—TRUCKS—Log, Express, Wheel Baggage.**Chatham Mfg Co. Ltd., Chatham, Ont. *Advt. page 245.***3557—TRUCKS—Brick.**Gurney Scale Co., Hamilton, Ont. *Advt. page 244.***3558—TRUCKS—Freight.***See No. 3556.***3559—TRUCKS—Electric Car, (Brill Patent).**Rathbun Co (The), Deseronto, Ont. *Advt. page 162.***3560—TRUCKS—(Framed Hand, Barrel, Half Round, Baggage, Cotton, Warehouse, Bag**Gurney Scale Co., Hamilton, Ont. *Advt. page 244.*  
Gowdy Mfg Co., Guelph, Ont.  
Dominion Snath Co., Waterville, Que. *Advt. p. 241.*  
Bell, B. & Son, St. George, Ont.  
Smarth (James) Mfg Co., Brockville, Ont. *Advt. 178.*  
Brown (G. & J.) Mfg Co., Belleville, Ont. *Advt. 198.*  
Burrow, Stewart & Milne, Hamilton, Ont.  
Macdonald, J. K., Montreal, Que. *Advt. page 247.*  
Carrier, Laine & Co., Levis, Que. *Advt. page 150.*  
London Foundry Co., London, Ont.**3561—TRUMPETS—Firemen's, Ear.**Chadwick Bros., Hamilton, Ont. *Advt. page 206.*  
Simpson, Hall, Miller & Co., Montreal, Que. *Advt. 203.***3562—TRUMPETS—(Fire), Plated Silver,**

Standard Silver Co. Ltd., Toronto, Ont.

**3563—TRUNKS—Travellers', Tourists', Sole Leather, Sample, Canvas, Covered, Marbleized, Crystalized, Toy, Veneer Box.**Christie, Bros. & Co., Amherst, N.S. *Advt. page 232.*  
Borbridge, S. & H., Ottawa, Ont.  
Eveleigh, J. & Co., Montreal, Que.  
Dillingham, W. B., Quebec, Que.  
Langmuir, M. Mfg Co., Toronto, Ont.  
O'Shaugnessey, Edward, St. John, N.B.  
Taylor, Robert & Co., Halifax, N.S.**3564—TRUSSER—(Machine) Barrel, 'Gordon'**Steinhoff & Gordon, Wallaceburg, Ont. *Advt. p. 192.***3565—TRUSSES—(Steel) Roof, Bridge, Building.**Dominion Bridge Co. Ltd., Montreal, Que. *Advt. 195.*  
Central Bridge & Engineering Co. Ltd., Peterboro, Ont. *Advt. page 214.*  
Loignon, A. & E., Montreal, Que. *Advt. page 247.***3566—TRUSSES—(Rupture Appliances) Electric, Spring, Hard Rubber, Web.**Lindman, B., Toronto, Ont. *Advt. page 249.*  
Armstrong, J. L., Ottawa, Ont.  
Gross, F., Montreal, Que.  
Montreal Silver Truss Co., Montreal, Que.  
Cluthe, Charles, Toronto, Ont.  
Authors & Cox., Toronto, Ont.**3567—TRYERS—(Steel) Butter, Cheese, Flour**Donaldson, Rob't & Sons, Montreal, Que. *Advt. 251.***3568—TUBES—Cotton Mill.**

Hambleton &amp; Co., Hampton, N. B.

**3569—TUBES—Glass Water Gauge.**Lamont Glass Co., New Glasgow, N.S. *Advt. p. 231.*  
Dominion Glass Works, Montreal, Que. *Advt. 221.***3570—TUBES—(Tin), Speaking.**Davidson Mfg Co. (Thos), Montreal, Que. *Advt. 225.***3571—TUBES—Pneumatic Dispatch.**Garth & Co., Montreal, Que. *Advt. page 154.***3572—TUBES—Copper, Brass.**American Copper Co., Toronto, Ont. *Advt. page 157.*  
Booth Copper Co., Toronto, Ont. *Advt. page 155.*  
Garth & Co., Montreal, Que. *Advt. page 154.*  
Macdonald & Co. Ltd., Halifax, N.S. *Advt. page 256.*  
Hamilton Brass Mfg Co., Hamilton, Ont. *Advt. 168.*  
Coulter & Campbell, Toronto, Ont. *Advt. page 201.*  
Parker, J. O. & Co., Toronto, Ont. *Advt. page 253.***3573—TUBES—Mailing.**Barber & Ellis Co. Ltd., Toronto, Ont. *Advt. p. 192.*  
Kilgour Bros., Toronto, Ont.  
Teller Mfg Co., Toronto, Ont.**3574—TUBES—(Rubber), Grain Drill.**Gutta Percha & Rubber Mfg Co., Toronto, Ont.  
*See back cover.*  
Canadian Rubber Co., Montreal, Que. *Advt. p. 197.*

**3575—TUBES—Boiler.**

Montreal Rolling Mills Co., Montreal, Que. *Advt.* 174.  
Babcock & Wilcox Co., Montreal, Que. *Advt.* p. 194.

**3576—TUBES—Locomotive Boiler.**

Montreal Rolling Mills Co., Montreal, Que. *Advt.* 174.

**3577—TUBING—Dental.** *See No.* 2869.**3578—TUBING—(Clay Pipe), Well.**

Standard Drain Pipe Co., St. Johns, Que. *Advt.* 251.

**3579—TUBING—(Cast Iron) Oil Well.**

Canada Pipe Foundry Co., Hamilton, Ont.  
Three Rivers Iron Co., Three Rivers, Que. *Advt.* 179.  
Fleck, Alex. Jr., Ottawa, Ont. *Advt.* page 252.  
Drummond, McCall Pipe Foundry Co., Montreal,  
Que. *Advt.* page 206.  
Garth & Co., Montreal, Que. *Advt.* page 154.

**3580—TUBING—(Rubber) Chemical, Corrugated, Flexible, Acid, Hard, Gas, Fire Extinguisher.**

Gutta Percha & Rubber Mfg Co. Ltd., Toronto, Ont.  
*See inside front cover.*  
Canadian Rubber Co., Montreal, Que. *Advt.* p. 197.

**3581—TUBS—Slate Laundry.**

New Rockland Slate Co., Montreal, Que. *Advt.* 244.  
Burns & Co., Halifax, N. S.

**3582—TUBS—(Boiling) Brewers'.**

Booth Copper Co., Toronto, Ont. *Advt.* page 155.  
Conlter & Campbell, Toronto, Ont. *Advt.* page 201.  
Garth & Co., Montreal, Que. *Advt.* page 154.

**3583—TUBS—Stoneware, Laundry.**

Hart Bros. & Lazier, Belleville, Ont. *Advt.* page 230.  
Brantford Stoneware Mfg Co., Brantford, Ont.  
*Advt.* page 251.  
Farrar, E. L., Iberville, Que.

**3584—TUBS—(Tin Lined) Butter.**

Cane & Sons Mfg Co. Ltd. (Wm.), Newmarket, Ont.  
*Advt.* page 218.  
Phillips, T. & Co., Orillia, Ont. *Advt.* page 259.

**3585—TUBS—(Stave) Butter.**

Cane & Sons Mfg Co. Ltd. (Wm.), Newmarket, Ont.  
*Advt.* page 218.  
Biette & Co., Chesley, Ont. *Advt.* page 240.  
Eastman Lumber Co., Eastman, Que.  
Macpherson & Schell, Alexandria, Ont.  
Eddy Co. Ltd. (The E. B.), Hull, Que.  
Fuller, Willard, Bolton Center, Que.  
Menosh & Welcome, South Stukely, Que.  
Scott & Goddard, Nnowlton, Que.  
Fessendeau, L. E., Fulford, Que.

**3586—TUBS—Granite Laundry.**

Canadian Granite Co. Ltd., Ottawa, Ont.

**3587—TUBS—Folding Bath.**

Otterville Mfg Co., Otterville, Ont. *Advt.* page 259.

**3588—TUBS—Bath (Copper & Zinc).**

Toronto Steel-Clad Bath & Metal Co. Ltd., Toronto,  
Ont. *Advt.* page 155.  
American Copper Co., Toronto, Ont. *Advt.* page 157.  
Coulter & Campbell, Toronto, Ont. *Advt.* page 201.

**3589—TUBS—(Bath) Steel Clad, Sanitary.**

Toronto Steel-Clad Bath & Metal Co. Ltd., Toronto,  
Ont. *Advt.* page 155.

**3590—TUGS—(Steam Warping) Lumberman's,**

West & Peachy, Simcoe, Ont. *Advt.* page 215.

**3591—TURNINGS—Wood.**

Gardner Bros., Essex, Ont.  
Otterville Mfg Co., Otterville, Ont. *Advt.* page 259.  
Wesley, F. J. & Co., Toronto, Ont.  
Strathroy Mfg Co., Strathroy, Ont.  
McLeod Bros., Truro, N.S.

**3591a—TURNBUCKLES.** *See No.* 520.**3592—TUYERES & FITTINGS—Bronze.**

Fraser Bros., New Glasgow, N.S. *Advt.* page 252.

**3593—TWEEDS—Waterproof,**

Canadian Rubber Co., Montreal, Que. *Advt.* p. 197.

**3594—TWEEDS—Canadian, "Blanketing".**

Hamelin & Ayers, Lachute Mills, Que. *Advt.* p. 188.  
Lomas Adam & Son, Sherbrooke, Que.  
Paton Mfg Co., Sherbrooke, Que.  
Granite Mills Co., St. Hyacinthe, Que.  
Slingsby Mfg Co. Ltd. (The), Brantford, Ont.  
Stanfield, C. E., Truro, N. S.  
Taylor, T. H. Co. Ltd., Chatham, Ont. *Advt.* p. 236.  
Waterhouse, Thomas, Palmerston, Ont.  
Willett, S. T., Chambly Canton, Que.  
Gilmore Woolen Mills (The), Joliette, Que.  
Almonte Blanket Mills, Almonte, Ont.  
Brook Woolen Co. Ltd. (The), Simcoe, Ont.  
Brodie & Co., Hespeler, Ont.  
Berry, M. B., Quebec, Que.  
Cornwall Mfg Co., Cornwall, Ont.  
Cobourg Woolen Co. Ltd., Cobourg, Ont.  
Globe Woolen Mills Co., Montreal, Que.  
Gillies Son & Co., Carleton Place, Ont.  
Grindrod, A. L. & Co., Sherbrooke, Que.  
Hawthorne Woolen Co. Ltd., Carleton Place, Ont.  
Hodge, William, Cornwall, Ont.  
Humphrey John A. & Son, Moncton, N. B.  
McKay Woolen Co., Charlottetown, P. E. I.  
Oxford Mfg Co. Oxford, N. S.  
Rosamond Woolen Co., Almonte, Ont.  
Trenholm & Armitage Mfg Co., Coaticook, Que.  
McLean, James, Pembroke, Ont.

**3595—TWINE—Lath.** *See Ties No.* 3464.**3596—TWINE—Binder.**

Farmers' Binder Twine & Agricultural Implements  
Mfg Co. of Brantford Ltd. (The), Brantford, Ont.

**3597—TWINE—(Fiber) Manilla, Flax, Jute, Wrapping.**

Canada Jute Co., Montreal, Que. *Advt.* page 225.  
Perine, M. B. & Co., Doon, Ont. *Advt.* page 181.  
Lochrie James, Toronto, Ont.

**3598—TWINE—(Cotton) Seine, Wrapping, Sail, Bag, Upholsters.**

Dominion Cotton Mills Co., Montreal, Que. *Advt.* 181.  
Parks, Wm. & Son, St. John, N.B. *Advt.* page 233.  
Canada Jute Co., Montreal, Que. *Advt.* page 225.  
Yarmouth Duck & Yarn Co., Yarmouth, N.S.  
Perine, M. B. & Co., Doon, Ont. *Advt.* page 181.  
Dovercourt Twine Mills Co., Toronto, Ont. *Advt.* 184.

**3599—TWIST—(Silk) Tram, Button Hole, Machine, Purse.**

Belding, Paul & Co., Montreal, Que. *Advt. page 183.*  
Corticelli Silk Co. Ltd., St. Johns, Que. *Advt. p. 182.*

**3600—TWISTERS—Ring (Wool).**

Karch, H. W., Hespeler, Ont.

**3601—TYPE—(Metal) Printing.**

Toronto Type Foundry Co. Ltd., Toronto, Ont.  
Dominion Type Foundry, Montreal, Que

**3602—TYPE—Rubber.**

Pritchard & Andrews, Ottawa, Ont. *Advt. page 250.*  
Tingley & Stewart Mfg Co., Toronto, Ont.  
Fell, I. C. & Co., Toronto, Ont.

**3603—TYPE—Brass, Steel.**

Pritchards & Andrews, Ottawa, Ont. *Advt. p. 250.*  
Patterson & Heward, Toronto, Ont. *Advt. p. 201.*

**3604—TYPE—WRITERS—"Blickensderfer".**

Creelman Bros., Georgetown, Ont.

**3605—UMBERS—(Painters) Raw Burnt.**

Argall, J. & Sons, Three Rivers, Que.

**3606—UMBRELLAS—Cotton, Silk.**

Gross, F. W., Montreal, Que.  
Irving & Co., Toronto, Ont.  
Montreal Suspender & Umbrella Mfg Co. (The),  
Montreal, Que.

**3607—UMBRELLAS—Wagon.**

Pike, D., Toronto, Ont. *Advt. page 182.*

**3608—UNDERWEAR—(Silk) Lisle Thread.**

Montreal Silk Mills Co. Ltd., Montreal, Que.  
Watson Mfg Co. Ltd. (The), St. Catharines, Ont.

**3609—UNDERWEAR—(Cotton) White.**

Watson Mfg Co. Ltd. (The), St. Catharines, Ont.  
Penman Mfg Co. Ltd., Paris, Ont.  
Allen Mfg Co., Toronto, Ont.  
Gale Mfg Co., Toronto, Ont.

**3610—UNDERWEAR—(Woolen) Knit, Arctic, Tropic.**

Turnbull, C. Co. Ltd., Galt, Ont. *Advt. page 203.*  
Eagle Knitting Co., Hamilton, Ont. *Advt. page 184.*  
Granite Mills Co., St. Hyacinthe, Que.  
Stanfield, C. E., Truro, N. S.  
Watson Mfg Co. Ltd. (The), St. Catharines, Ont.  
Fraser, Donald M., Almonte, Ont.  
Almonte Knitting Co. Ltd., Almonte, Ont.  
Schofield Woolen Co., Oshawa, Ont.

**3611—UPSETTER—Bolt.**

Bertram, John & Sons, Dundas, Ont. *Advt. p. 161.*  
Stevens, Hamilton & Co., Galt, Ont.

**3612—UPSETTERS—Tire.**

Jardine, A. B. & Co., Hespeler, Ont. *Advt. p. 217.*  
Smart, (Jas.) Mfg Co., Brockville, Ont. *Advt. p. 178.*  
Butterfield & Co., Rock Island, Que.

**3613—URINALS—Iron.**

Young & Bro. Co. Ltd., Hamilton, Ont. *Advt. p. 257.*

**3614—URINALS—Slate.**

Danville Asbesto & Slate Co., Danville, Que.  
Burns & Co., Halifax, N. S.

**3615—URINALS—Rubber. See No. 2869.**

**3616—URINALS—(Rockingham Ware) Hand, Male & Female.**

Campbell, R., Hamilton, Ont. *Advt. page 230.*

**3617—URINALS—C. C. Ware.**

Dominion Sanitary Pottery Co., St. Johns, Que.  
Campbell & Purvis, St. Johns, Que. *Advt. page 253.*

**3618—URNS—(Cast Iron) Stove. See No. 3316**

**3619—URNS—Stove, Spun Metal, Hot Water.**

Chadwick Bros., Hamilton, Ont. *Advt. page 206.*  
Parker, J. O. & Co., Toronto, Ont. *Advt. page 253.*  
American Copper Co., Toronto, Ont. *Advt. page 157.*

**3620—URNS—Tea, Coffee.**

Mitchell, Robert & Co., Montreal, Que. *Advt. p. 213.*  
Booth Copper Co., Toronto, Ont. *Advt. page 155.*  
Parker, J. O. & Co., Toronto, Ont. *Advt. page 253.*  
Morrison Brass Mfg Co. (Jas.), Toronto, Ont. *Advt. 157.*

**3621—VALANCES.**

McKinnon Dash & Hardware Co., St. Catharines,  
Ont. *Advt. page 202.*

**3622—VALISES—(Leather) Travelers, Tourists, Sample. See No. 3563.**

**3623—VALVES—(Brass) Asbestos Packed, Ball, Corner, Cross, Float, Flushing, Globe, Locomotive, Quick Opening, Pop Safety, Lock.**

Mitchell, Robert & Co., Montreal, Que. *Advt. p. 213.*  
Garth & Co., Montreal, Que. *Advt. page 154.*  
Parker, J. O. & Co., Toronto, Ont. *Advt. page 253.*  
MacDonald & Co., Ltd., Halifax, N.S. *Advt. p. 256.*  
Robb Engineering Co. Ltd, Amherst, N.S.

*See inside front cover.*

Kerr Engine Co. Ltd., Walkerville, Ont. *Advt. 208.*  
Morrison Jas. Brass Mfg Co., Toronto, Ont. *Advt. 157.*  
McAvity, T. & Sons, St. John, N.B. *Advt. page 153.*  
Laurie Engine Co., Montreal, Que. *Advt. page 179.*  
Goldie & McCulloch Co., Galt, Ont. *Advt. page 159.*  
Ontario Engine & Machine Co. Ltd., Toronto, Ont. *Advt. page 177.*

**3624—VALVES—(Rubber) Acid, Air.**

Canadian Rubber Co., Montreal, Que. *Advt. page 197.*  
Gutta Percha & Rubber Co., Toronto, Ont.

*See back cover.*

**3625—VALVES—(Iron) "Lunken", Patent, Straight Way.**

Kerr Engine Co. Ltd., Walkerville, Ont. *Advt. 208.*

**3626—VALVES—(Automatic) "Van Suken", "Jenkin".**

Morrison Brass Mfg Co. (Jas.), Toronto, Ont. *Advt. 157.*

**3627—VALVES—(Radiator) Steam, Water.**

Toronto Radiator Mfg Co., Toronto, Ont. *Advt. 152.*  
McAvity, T. & Sons, St. John, N.B. *Advt. page 153.*  
Star Iron Co., Montreal, Que. *Advt. page 243.*  
Macdonald & Co., Ltd., Halifax, N.S. *Advt. p. 256.*  
Morrison Jas. Brass Mfg Co., Toronto, Ont. *Advt. 157.*  
Goldie & McCulloch Co., Galt, Ont. *Advt. page 159.*

- Robb Engineering Co. Ltd., Amherst, N.S.  
*See inside front cover.*
- Kerr Engine Co., Ltd., Walkerville, Ont. *Advt.* 208.
- 3628—VALVES—(Float) Water Closet.**  
Morrison Jas. Brass Mfg Co., Toronto, Ont. *Advt.* 157.  
McAvity, T. & Sons, St. John, N.B. *Advt. page* 153.  
American Copper Co., Toronto, Ont. *Advt. page* 157.  
Booth Copper Co., Toronto, Ont. *Advt. page* 155.  
Mitchell, Robert & Co., Montreal, Que. *Advt. p.* 213.  
Parker, J. O., Toronto, Ont. *Advt. page* 253.  
Young & Bro. Co. Ltd., Hamilton, Ont. *Advt. p.* 257.  
Coulter & Campbell, Toronto, Ont. *Advt. page* 201.  
Chadwick Bros., Hamilton, Ont. *Advt. page* 206.
- 3629—VALVES.—(J. M. T.)**  
Morrison Jas. Brass Mfg Co., Toronto, Ont. *Advt.* 157.
- 3630—VALVES—(Iron) Stop, Angle, Hydraulic, Water-Works, Gas Works, Straight-way, Gate, Y.**  
Ontario Engine & Machine Co. Ltd., Toronto, Ont. *Advt. page* 177.  
Macdonald & Co. Ltd., Halifax, N. S. *Advt. p.* 256.  
Carrier, Laine & Co., Levis, Que. *Advt. page* 150.  
Nie & Whitfield, Hamilton, Ont.  
Kerr Engine Co. Ltd., Walkerville, Ont. *Advt. p.* 208.  
Morrison, (Jas.) Brass Mfg Co., Toronto. *Advt.* 157.  
Goldie & McCulloch Co. Ltd., Galt, Ont. *Advt.* 159.  
Robb Engineering Co. Ltd., Amherst, N. S.  
*See inside front cover.*  
Star Iron Co., Montreal, Que. *Advt. page* 243.  
McAvity, T. & Sons, St. John, N. B. *Advt. page* 153.  
Laurie Engine Co., Montreal, Que. *Advt. page* 179.  
Garth & Co., Montreal, Que. *Advt. page* 154.  
Three Rivers Iron Works, Three Rivers, Que. *Advt. page* 179.
- 3631—VANES—Weather.**  
Ives, H. R. & Co., Montreal, Que. *Advt. page* 200.  
Dennis Wire & Iron Works, London, Ont. *Advt.* 207.
- 3632—VANS—Furnitures.** *See No.* 3679.
- 3633—VARNISH—Stove Pipe.**  
Domestic Specialty Co., Hamilton, Ont. *Advt. p.* 227.  
McCrea & Hanes, Toronto, Ont. *Advt. page* 248.
- 3634—VARNISH—Dipping, Rubbing, Black, Asphaltum, Body, Oil Cloth, Whip, Shellac.**  
Ramsay, A. & Son, Montreal, Que. *Advt. page* 211.  
Canada Paint Co. Ltd., Montreal, Que. *Advt. p.* 221.  
McCaskill, Dougall & Co., Montreal, Que. *Advt.* 245.
- 3635—3636 — VARNISHES — Agricultural, Brewers, Cabinet Makers', Carriage Makers', Car Shop, Furniture Makers, House Painters', Interior Japanners, Piano Makers', Printers', Spirit, "Japans", "Dryers", &c.**  
Canada Paint Co. Ltd., Montreal, Que. *Advt. p.* 221.  
Farr, J. H. & Co., Toronto, Ont. *Advt. page* 211.  
Jameison, R. C. & Co., Montreal, Que.  
McCaskill, Dougall & Co., Montreal, Que. *Advt.* 245.  
Scarfe & Co., Brantford, Ont.  
McArthur, Corneille & Co., Montreal, Que. *Advt.* 221.  
Ramsay, A. & Son, Montreal, Que. *Advt. page* 211.  
MacKenzie, D. A. & Co., Toronto, Ont. *Advt. p.* 243.  
Baylis Mfg Co., Montreal, Que.
- 3637—VARNISH—Shingle.**  
Paterson, J. W. & Co., Montreal, Que.
- 3638—VASELINE—Cold Cream.**  
Cheseborough Mfg Co., Montreal, Que. *Advt. p.* 259.
- 3639—VASES—Brass.**  
Chadwick Bros., Hamilton, Ont. *Advt. page* 206.
- 3640—VASES—(Stoneware) Park, Lawn.**  
Brantford Stoneware Mfg Co., Brantford, Ont. *Advt. page* 251.
- 3641—VASES—(Iron), Lawn, Garden.**  
Dennis Wire & Iron Works, London, Ont. *Advt.* 207.  
Ives, H. R. & Co., Montreal, Que. *Advt. page* 200.  
Nichols, Thomas E., Hamilton, Ont.
- 3642—VASES—(Sheet Iron) Coal.**  
Kemp Mfg Co., Toronto, Ont.
- 3643—VASES—Soap.** *See No.* 179.
- 3644—VASES—Plated.**  
Simpson, Hall, Miller & Co., Montreal, Co. *Advt.* 203.
- 3645—VASES—(Lawn) Terra Cotta.**  
Beamsville Pressed Brick Co., Beamsville, Ont. *Advt. page* 215.
- 3646—VATS — (Cheese Factory) Cheese, Cream, Cooling, Steam.**  
Bessette, J. & S., Iberville, Que.  
Chown, W. W. & Co., Belleville, Ont. *Advt. p.* 233.  
Lancaster Machine Works, Lancaster, Ont. *Advt.* 248.  
Richardson & Webster, St. Mary's, Ont.
- 3647—VAULTS—(Slate) Cemetery.**  
New Rockland Slate Co., Montreal, Que. *Advt.* 244.
- 3648—VAULTS—(Steel) Bank, Safe, Deposit.** *See No.* 2887.
- 3649—VAULTS—(Iron) Grave, "Gates".**  
Carricr, Laine & Co., Levis, Que. *Advt. page* 150.  
Dennis Wire & Iron Works, London, Ont. *Advt.* 207.
- 3650—VELOCIPEDES—Railway.**  
Brown (G. & J.) Mfg Co., Belleville, Ont. *Advt.* 198.  
Rhodes, Curry & Co., Amherst, N.S. *Advt. page* 158.  
Bessette, J. & S., Iberville, Que.
- 3651—VENEERS—Cheese Box.**  
Acme Veneer Works, Orillia, Ont. *Advt. page* 217.  
Macpherson & Schell, Alexandria, Ont.
- 3652—VENEERS—Mirror Back, House Decoration, Fancy, Berry Box, Desk, Cutter Body, Wash Board.**  
Acme Veneer Works, Orillia, Ont. *Advt. page* 217.  
Toronto Hoop & Veneer Co., Toronto, Ont. *Advt.* 234.
- 3653—VENEERS—Brush Back.**  
Acme Veneer Works, Orillia, Ont. *Advt. page* 217.  
Toronto Hoop & Veneer Co., Toronto, Ont. *Advt.* 234.  
Kaufman, Jacob, Berlin, Ont.  
Lewis, J. & Sons, Truro, N.S.
- 3654—VENEERS — Organ, Piano, Basket, Carriage, Car, Furniture, Fanning Mill, Dash, Trunk.**  
Toronto Hoop & Veneer Coy, Toronto, Ont. *Advt.* 234.



- Acme Veneer Works, Orillia, Ont. *Advt. page 217.*  
Ontario Basket Co. Ltd., Walkerville, Ont.
- 3655—VENSOLINE.**  
McCrea Hanes Coy., Toronto, Ont. *Advt. page 248.*
- 3656—VENTILATORS—Rotary “Æolian”.**  
Lessard & Harris, Montreal, Que. *Advt. page 231.*
- 3657—VENTILATORS—Stable.** *See No. 1831.*
- 3658—VENTILATORS—(Window), Church.**  
Elliott & Son, Toronto, Ont.
- 3659—VENTILATORS—(Iron Flue).**  
Lessard & Harris, Montreal, Que. *Advt. page 231.*  
Burrow, Stewart & Milne, Hamilton, Ont.  
Metallic Roofing Co., Toronto, Ont. *See front fly leaf.*  
Gurney, Tilden Co. Ltd., Hamilton, Ont. *Advt. 151.*  
Garth & Co., Montreal, Que. *Advt. page 154.*  
Carrier, Laine & Co., Levis, Que. *Advt. page 150.*  
Ives, H. R. & Co., Montreal, Que. *Advt. page 200.*
- 3660—VERMICELLI & MACARONI.**  
Catelli, C. H., Montreal, Que.  
Spinelli, D., Montreal, Que.
- 3661—VESSELS—(Rubber) Acid.** *See No. 2869.*
- 3662—VESSELS—Chemical (Stoneware).**  
Brantford Stoneware Mfg Co., Brantford, Ont.  
*Advt. page 251.*
- 3663—VESSELS—Sailing, Steel, Wood.**  
Rathbun Co. (The), Deseronto, Ont. *Advt. page 162.*  
Matheson, I. & Co., New Glasgow, N.S. *Advt. 200.*
- 3664—VESTS—(Ladies’), Ribbed, Knitted.**  
Eagle Knitting Co., Hamilton, Ont. *Advt. page 184.*  
Turnbull, C. Co. Ltd., Galt, Ont. *Advt. page 203.*
- 3665—VIADUCTS—Iron & Steel.** *See No. 495.*
- 3666—VINEGARS—Cider, Proof, Malt, Wine.**  
Haaz, A. & Co., Kingston, Ont.  
Hamilton Vinegar Works, Hamilton, Ont.  
Drouin Bros. & Co., Quebec, Que.  
Lefebvre, Michel & Co., Montreal, Que.  
Brousseau & Co., Montreal, Que.  
Brown & Webb, Halifax, N. S.  
Badgerow & Dixon, Toronto, Ont.  
Lytle, T. A. & Co., Toronto, Ont.
- 3667—VISES—Saw.** *See No. 3669.*
- 3668—VISES—Blacksmiths’, Pipe.** *S. No. 3669.*
- 3669—VISES—(Saw) Swivel, Solid Box, Parallel, Offset Jaw, Jewelers’, Heavy Chipping, Bench, Amateur.**  
Jardine, A. B. & Co., Hespeler, Ont. *Advt. page 217.*  
Smart, (Jas.) Mfg Co., Brockville, Ont. *Advt. p. 178.*  
Garth & Co., Montreal, Que. *Advt. page 154.*  
Brown, Bogg & Co., Hamilton, Ont. *Advt. page 193.*  
Ives, H. R. & Co., Montreal, Que. *Advt. page 200.*  
Woodyatt, A. R. & Co., Guelph, Ont. *Advt. p. 207.*  
Bessette, J. & S., Iberville, Que.  
Butterfield & Co., Rock Island, Que.
- 3670—VOLTMETERS.**  
Whitney Electrical Instrument Co., Sherbrooke, Que
- 3671—WADDING—Cotton.**  
Dominion Wadding Co., Montreal, Que. *Advt. 183.*

- 3672—WARPS—(Cotton) Blanket, Carpet, Chain Beam.**  
Hamilton Cotton Co., Hamilton, Ont. *Advt. p. 188.*  
Canadian Col. Cotton Mills Co., Montreal. *Advt. 181.*  
Parks, William & Son, St. John, N.B. *Advt. p. 233.*
- 3673—WAFERS—(Headache) Stearns.**  
Stearns Fred’k & Co., Windsor, Ont. *See back cover.*
- 3674—WAGONS—Holly Patent “Sloven” (low down Crank Axle).**  
Bain Bros. Mfg Co. Ltd., Brantford, Ont. *Advt. 249.*
- 3675—WAGONS—One Horse, Two Horse, Ice, Railway, Truck, Ore, Lumber, Log, Grain, Farm, Freight, Coal & Coke, Mountain, Lorrie, (Singletrees & Whiffletrees).**  
Chatham Mfg Co. Ltd., Chatham, Ont. *Advt. p. 245.*  
Speight Wagon Co., Markham, Ont. *Advt. page 245.*  
Smith Bros., Toronto, Ont. *Advt. page 178.*  
Jeffrey Bros., Cote Visitation, Que.  
Bain Bros. Mfg Co., Brantford, Ont. *Advt. page 249.*
- 3676—WAGONS—Coal, (Automatic Dump).**  
Smith Bros., Toronto, Ont. *Advt. page 178.*
- 3677—WAGONS—(Basket) Invalid.**  
Watts, Charles, Toronto, Ont.
- 3678—WAGONS—(Toy) Express.** *See No. 645.*
- 3679—WAGONS—Bakers’, Business, Brewers’, Butchers’, Democrat, Delivery, Express, Grocers, Laundry, Milk, Market, Mail, Patrol, Spring, Undertakers, (Vehicle Cutters) Sleighs.**  
Bain Bros. Mfg Co., Brantford, Ont. *Advt. page 249.*  
Chatham Mfg Co., Chatham, Ont. *Advt. page 245.*  
Campbell, John, London, Ont.  
Ashley Carriage Works, Belleville, Ont. *Advt. p. 204.*  
Auld, J. W., Hamilton, Ont. *Advt. page 223.*  
Kingston Vehicle Co., Kingston, Ont. *Advt. p. 202.*  
Smith Bros., Toronto, Ont. *Advt. page 178.*  
Edcombe Bros., Fredericton, N.B.
- 3680—WAGONETTES—Light.**  
St. Charles Omnibus Co., Belleville, Ont.  
Campbell, John, London, Ont.
- 3681—WAINSCOTTING—Slate.**  
New Rockland Slate Co., Montreal, Que. *Advt. 244.*
- 3682—WAINSCOTING—(Soft & Hardwood).** *See No. 727.*
- 3683—WAITERS—(Dumb) Hotel, Restaurant, Basement.**  
Myers, W. F. & J. W., St. John, N. B. *Advt. p. 163.*  
Fensom, John, Toronto, Ont.  
Ives, H. R. & Co., Montreal, Que. *Advt. page 200.*
- 3684—WALLETS—Leather.**  
Brown Bros. Ltd. (The), Toronto, Ont.
- 3685—WARDROBES—Office, Walnut, Stained**  
Canadian Office & School Furniture Co. Ltd. (The), Preston, Ont. *Advt. page 210.*  
Rhodes, Curry & Co., Amherst, N. S. *Advt. p. 158.*  
Tees & Co., Montreal, Que. *Advt. page 225.*

**3686—WARE—Chesterfield, Brown, Buff, Bristol.**

Brantford Stoneware Mfg Co. (The), Brantford, Ont.  
*Advt. page 251.*

**3687—WARE—Sanitary, Pottery.**

Dominion Sanitary Pottery Co., St. Johns, Que.  
*Advt. page 253.*  
St. Johns Stone Chinaware Co., St. Johns, Que.

**3688—WARE—(Porcelain) Electric.**

Peterboro Carbon & Porcelain Co. Peterboro, Ont.

**3689—YELLOW WARE.**

Campbell, R., Hamilton, Ont. *Advt. page 230.*  
Brantford Stoneware Mfg Co. Ltd. (The), Brantford, Ont. *Advt. page 251.*  
Hart Bros. & Lazier, Belleville, Ont. *Advt. page 230.*

**3690—WASTE—Wiping.**

Montreal Cotton & Wool Waste Co., Montreal, Que.

**3691—WATERS.**

Rowe, Frank W. & Co., Montreal, Que. *Advt. p. 235.*

**3692—WARMERS—(Stone) Foot. See No. 2586.**

**3693—WASHERS—Lead.**

**3694—WASHERS—Gauge Glass, Bottle.**

Mitchell, Rob't & Co., Montreal, Que. *Advt. p. 213.*  
Morrison, Jas. Brass Mfg Co., Toronto. *Advt. p. 157.*

**3695—WASHERS—(Clothes) "Dowswell".**

Dowswell Bros. & Co., Hamilton, Ont. *Advt. p. 243.*

**3696—WASHERS—(Rubber) Air Brake, Hose.**

Canadian Rubber Co., Montreal, Que. *Advt. p. 197.*

**3697—WASHERS—(Leather) Carriage.**

Robin, Sadler & Haworth, Montreal, Que. *Advt. 226.*

**3698—WASHERS—Cork.**

Cork Co. of Canada, Ltd., Toronto, Ont. *Advt. 187.*

**3699—WASHERS—(Cast) Brass.**

Parker, J. O. & Co., Toronto, Ont. *Advt. page 253.*  
Morrison, James. Brass Mfg Co., Toronto, Ont.  
*Advt. page 157.*

**3700—WASHERS—(Iron) Axle, Bolt, Car, Ry. Track, Steel, Special.**

Abbott & Co., Montreal, Que. *Advt. page 196.*  
Cowen & Britton, Gananoque, Ont.  
Carrier, Laine & Co., Levis, Que. *Advt. page 150.*  
Swansea Forging Co. Ltd., Swansea, Ont. *Advt. 156.*  
Starr Mfg Co. Ltd., Halifax, N. S. *Advt. page 199.*

**3701—WASHERS—(Woolen Mill) Cloth.**

Goldie & McCulloch Co., Galt, Ont. *Advt. page 159.*  
Karch, H. W., Hespeler, Ont.  
Young Bros., Almonte, Ont. *Advt. page 250.*

**3702—WASHERS—Carriage Prop.**

McKinnon Dash & Hardware Co., St. Catharines, Ont. *Advt. page 202.*

**3703—WASTE—Rare Cotton.**

Hamilton Cotton Co., Hamilton, Ont. *Advt. p. 188.*

**3704—WASTE—Wool.**

Bauer, A. & Co. Waterloo, Ont. *Advt. page 185.*

Montreal Cotton & Wool Waste Co., Montreal, Que.  
Canada Garnetting Co., Montreal, Que.  
Shepherd, David, Almonte, Ont.

**3705—WASTE—Cotton.**

Dominion Wadding Co., Montreal, Que. *Advt. 183.*  
Hamilton Cotton Co., Hamilton, Ont. *Advt. p. 188.*  
Montreal Cotton & Wool Waste Co., Montreal, Que.  
Parks, Wm. & Sons, St. John, N.B. *Advt. page 233.*  
Canadian Col. Cotton Mills Co., Montreal, Que. *Advt. 181.*  
Dominion Cotton Mills Co., Montreal, Que. *Advt. 181.*

**3706—WATERS—Distilled.**

Hamilton Vinegar Works, Hamilton, Ont.  
Kerry, Watson & Co., Montreal, Que.  
Lyman, Sons & Co., Montreal, Que.

**3707—WATERS—Medicinal.**

Stearns Fred'k & Co., Windsor, Ont. *See back cover.*

**3708—WATER—Vichy, Lithia, Table Waters.**

Gurd, Charles & Co., Montreal, Que. *Advt. page 235.*  
Wilson, Charles, Toronto, Ont.

**3710—WAX—Bottle.**

Canada Cork Cutting Co., Montreal, Que. *Advt. 223.*

**3711—WAX—Refined.**

Imperial Oil Co., Petrolia, Ont. *Advt. page 230.*  
Fairbank, Rogers & Co., Petrolia, Ont.

**3712—WAX—Paraffine, Tanners'.**

Rogers, Samuel & Co., Toronto, Ont. *Advt. p. 240.*  
Imperial Oil Co., Petrolia, Ont. *Advt. pag 230.*

**3713—WEANERS—(Calf) Adjustable.**

Woodyatt, A. R. & Co., Guelph, Ont. *Advt. p. 207.*

**3714—WEASANDS—Hog.**

Harris, W. & Co., Toronto, Ont.

**3715—WEBS—Saw.**

Robertson, (Jas.), Co., Toronto, Ont. *Advt. p. 167.*  
Pontbriand & Bros., Sorel, Que.  
Burns Saw Co. (E. R.), Toronto, Ont.  
Shurly & Deitrich, Galt, Ont.

**3716—WEBBINGS—(Elastic), Loom, Suspender, Garter.**

Canadian Elastic Webb Co., Niagara Falls, Ont.

**3717—WEBBINGS—(Non-Elastic) Halter, Girth, Bolt, Cloth, Boot & Shoe.**

Hamilton Cotton Co., Hamilton, Ont. *Advt. p. 188.*

**3718—WEDGES—Ry. Track.**

Brown (G. & J.) Mfg Co., Belleville, Ont.

**3719—WEDGES—Iron & Steel, Stone, Wood-Splitting.**

Whitman & Barnes Mfg Co., St. Catharines, Ont.  
Gardner Tool Co. (W. R.), Brockville, Ont.

**3720—WEIGHTS—(Iron) Scale. See No. 3721.**

**3721—WEIGHTS—(Scale) Beam, Bottom.**

Gurney Scale Co., Hamilton, Ont. *Advt. page 244.*  
Pritchard & Andrews, Ottawa, Ont. *Advt. page 250.*  
Burrow, Stewart & Milne, Hamilton, Ont.

**3722—WEIGHTS—(Glass) Paper, Advertising**

Hobbs Mfg Co., London, Ont. *Advt. page 212.*

**3723—WEIGHTS—(Lead) Hitching.**

Smart, (Jas.), Mfg Co., Brockville, Ont. *Advt. p. 178.*

**3724—WEIGHTS—(Lead) Sash.**

Ontario Lead & Barb Wire Co., Toronto, Ont.  
Brown, Boggs & Co., Hamilton, Ont. [*Advt. 177.*]  
Garth & Co., Montreal, Que. *Advt. page 154.*

**3725—WEIGHTS — (Iron) Clock, Dumb Waiter, Elevator, Sash, Hitching.**

Carrier, Laine & Co., Levis, Que. *Advt. page 150.*  
Gurney, Tilden Co. Ltd., Hamilton, Ont. *Advt. 151.*  
Kerr & Morgan, Montreal, Que. *Advt. page 220.*  
Miller Bros. & Toms, Montreal, Que. *Advt. page 197.*  
Smart, (Jas.) Mfg Co., Brockville, Ont. *Advt. p. 178.*  
Sleeper & Akhurst, Coaticook, Que. *Advt. page 241.*  
Garth & Co., Montreal, Que. *Advt. page 154.*  
Ives, H. R. & Co., Montreal, Que. *Advt. page 200.*

**3725a—WELLS—Ore.**

Mac Machine Co., Belleville, Ont. *Advt. page 194.*

**3726—WELLS—(Iron) Ink, Water, Copying.**

Smart, (Jas.) Mfg Co., Brockville, Ont. *Advt. page 178.*

**3727—WELTS—(Leather) Shoe.**

Porter, Henry, Montreal, Que. *Advt. page 239.*

**3728—WELTING—Goodyear Shoe.**

Robin, Sadler & Haworth, Montreal, Que. *Advt. 226.*

**3729—WHEELS—(Iron) Hub, Agricultural.**

Matheson, I. & Co., New Glasgow, N. S. *Advt. p. 200.*  
Bell, B. & Son, St. George, Ont.  
Gowdy Mfg Co., Guelph, Ont.

**3730—WHEELS—(Grinding) Clay.**

Goldie & McCulloch Co. Ltd., Galt, Ont. *Advt. p. 159.*

**3731—WHEELS — (Fifth) "Cincinnati", "Birdsalls", Derby.**

Gillies, Geo. (The) Co., Gananoque, Ont. *Advt. p. 156.*

**3732—WHEELS—Brass, Copper, Zinc, Tin.**

Chadwick Bros., Hamilton, Ont. *Advt. page 206.*

**3733—WHEELS—(Yarn) Spinning.**

Goulette, O. V., Gananoque, Ont. *Advt. page 214.*  
Connor, J. H., Ottawa, Ont.

**3734—WHEELS—(Mill) Bull.**

Canadian Locomotive & Engine Co. Ltd., Kingston, Ont. *Advt. page 175.*

**3735—WHEELS—(Oil Pump) Jerker.**

McKee & Marwick, Petrolia, Ont.  
Oil Well Supply Co., Petrolia, Ont.

**3736—WHEELS—Friction.**

Jenckes Machine Co., Sherbrooke, Que. *Advt. p. 165.*  
Hart Emery Wheel Co., Hamilton, Ont. *Advt. p. 166.*

**3737—WHEELS—(Bicycle) Pneumatic, Sulky**

Goold Bicycle Co. (The), Brantford, Ont. *Advt. p. 220.*  
Kingston Vehicle Co., Kingston, Ont. *Advt. p. 202.*  
Gendron Mfg Co. Ltd., Toronto, Ont. *Advt. p. 187.*

**3738—WHEELS—Sprocket.**

Matheson, I. & Co., New Glasgow, N. S. *Advt. p. 200.*  
Carrier, Laine & Co., Levis, Que. *Advt. page 150.*

**3739—WHEELS—(Barbers') Brush.**

Bryan, Thomas, London, Ont. *Advt. page 212.*  
Meakins & Co., Montreal, Que. *Advt. page 237.*

**3740—WHEELS—Fly.**

Brown (G. & J.) Mfg Co., Belleville, Ont. *Advt. 198.*  
Bertram, John & Sons, Dundas, Ont. *Advt. page 161.*  
Jenckes Machine Co., Sherbrooke, Que. *Advt. p. 165.*  
Gardner, Robt. & Son, Montreal, Que.

**3741—WHEELS — Propeller, Maganese, Bronze.**

Waring, White & Co., St. John, N.B. *Advt. page 256.*  
Canadian Locomotive & Engine Co., Kingston, Ont. *Advt. page 175.*  
Carrier, Laine & Co., Levis, Que. *Advt. page 150.*  
Raney, Reid & Selby, Kingston, Ont.  
Matheson, I. & Co., New Glasgow, N.S. *Advt. p. 200.*

**3742—WHEELS—Carriage & Wagon.**

Woodburn Sarven Wheel Co., St. Catharines, Ont.  
Victoria Wheel Works, Galt, Ont. [*Advt. page 241.*]  
Ontario Wheel Co., Gananoque, Ont.  
Hore's, F. W., Sons, Hamilton, Ont.

**3743—WHEELS—(Wood) Barrow.**

Walker, J. (Estate of), Toronto, Ont.  
McVean, O. & W., Dresden, Ont.

**3744—WHEELS—(Slush) Tanners'.**

Woon, Robert & Co., Oshawa, Ont. *Advt. page 210.*

**3745—WHEELS—Tire Measuring.**

Butterfield & Co., Rock Island, Que.

**3746—WHEELS —(Tanners') Paddle, Tin.**

Bateman, Wm., Montreal, Que. *Advt. page 247.*

**3747—WHEELS—Ship Steering, Yacht Steering.**

Bradley Bros., St. John, N.B.

**3748—WHEELS—Trolley.**

Ingersoll Rock Drill Co., Montreal, Que. *Advt. 198.*

**3749—WHEELS—(Emery) Polishing, Saw Sharpening, Saw Gumming, Tool Grinding, Foundry, Buffing.**

Hart Emery Wheel Co., Hamilton, Ont. *Advt. p. 166.*  
Prescott Emery Wheel Co., Prescott, Ont. *Advt. 237.*

**3750—WHEELS—Metal, Children's Carriage.**

Gendron Mfg Co., Toronto, Ont. *Advt. page 187.*

**3751—WHEELS—(Emery) "Crescent".**

Prescott Emery Wheel Co., Prescott, Ont. *Advt. 237.*

**3752—WHEELS—(Porcelain) Caster.**

Peterboro Carbon & Porcelain Co., Peterboro, Ont.

**3753—WHEELS—"Warner's Patent", "Sarven Patent".**

Woodburn Sarven Wheel Co., St. Catharines, Ont. *Advt. page 241*

**3754—WHEELS—(Water) Horizontal, Vertical, "Impulse".**

Jenckes Machine Co., Sherbrooke, Que. *Advt. p. 165.*  
Canadian Rand Drill Co., Sherbrooke, Que. *Advt. 165*

**3755—WHEELS—Water, “Leffel”.**

Paxton, Tate & Co., Port Perry, Ont.  
Woon, Robert & Co., Oshawa, Ont. *Advt. page 210.*

**3756—WHEELS — (Water) “Perfection”,  
“Vulcan”.**

Paxton, Tate & Co., Port Perry, Ont.

**3757—WHEELS — (Emery) Corundum,  
Waterproof, Household.**

Hart Emery Wheel Co., Hamilton, Ont. *Advt. 166.*  
Prescott Emery Wheel Co., Prescott, Ont. *Advt. 237.*

**3758—WHEELS—Water Turbine.**

Goldie & McCulloch Co. Ltd., Galt, Ont. *Advt. p. 159.*  
Fleck, Alex. Jr., Ottawa, Ont. *Advt. page 252.*  
Paxton, Tate & Co., Port Perry, Ont.  
Lloyd Mfg Co., Kentville, N. S.  
Woon, Robert & Co., Oshawa, Ont. *Advt. p. 210.*  
Hamilton Mfg Co. Ltd. (Wm.), Peterboro, Ont.  
Wilson, J. C. & Co., Glenora, Ont.  
Robb Engineering Co. Ltd., Amherst, N. S.

*See inside front cover.*

**3759—WHEELS—(Cast Steel), Car, Chilled  
Cast, Sectional, Street Car, Ry. Car,  
(Engine Drive).**

Montreal Car Wheel Co., Montreal, Que. *Advt. p. 206.*  
McDougall, John & Co., Montreal, Que. *Advt. 199.*  
Carrier, Laine & Co., Levis, Que. *Advt. page 150.*

**3760—WHEELS—(Iron), Propeller.**

Canadian Locomotive & Engine Co. Ltd., Kingston,  
Ont. *Advt. page 175.*  
Fleck, Alex. Jr., Ottawa, Ont. *Advt. page 252.*  
Waring, White & Co., St. John, N. B. *Advt. p. 256.*  
Matheson, I. & Co., New Glasgow, N.S. *Advt. p. 200.*  
Carrier, Laine & Co., Levis, Que. *Advt. page 150.*  
Bertram Engine Works Co., Toronto, Ont.

**3761—WHEELS—(Iron) Barrow, Hand Truck,  
Platform Truck, Mine Car, Hand Car.**

Carrier, Laine & Co., Levis, Que. *Advt. page 150.*  
Brown, (G. & J.) Mfg Co., Belleville, Ont. *Advt. 198.*  
London Foundry Co. Ltd., London, Ont.  
Ives, H. R. & Co., Montreal, Que. *Advt. page 200.*  
Garth & Co., Montreal, Que. *Advt. page 154.*

**3762—WHEELS—Ratchet, Worm.**

Robb Engineering Co. Ltd., Amherst, N. S.  
*See inside front cover.*  
Brush, Geo., Montreal, Que.  
Bertram, John & Sons, Dundas, Ont. *Advt. page 161.*  
Fleck, Alex. Jr., Ottawa, Ont. *Advt. page 252.*  
Goldie & McCulloch Co. Ltd., Galt, Ont. *Advt. 159.*  
Carrier, Laine & Co., Levis, Que. *Advt. page 150.*

**3763—WHEELS—(Iron), Gear.**

Brown, (G. & J.) Mfg Co., Belleville, Ont. *Advt. 198.*  
Robb Engineering Co. Ltd., Amherst, N. S.  
*See inside front cover.*  
Bertram, John & Sons, Dundas, Ont. *Advt. page 161.*  
Goldie & McCulloch Co. Ltd., Galt, Ont. *Advt. 159.*  
Macdonald & Co. Ltd., Halifax, N.S. *Advt. page 256.*  
Lancaster Machine Works, Lancaster, Ont. *Advt. 248*

**3764—WHEEL—BARROWS—Canal, Mortar,  
Railroad. *See No. 3765.*****3765—WHEEL-BARROWS—(Wood), Farm-  
ers', Garden, Side-Board.**

Maxwell, David & Sons, St. Mary's, Ont. *Advt. 250.*  
Coleman, T. T. (Estate of), Seaforth, Ont.  
Wilkinson Plow Co. Ltd, Toronto, Ont.  
Bell, B. & Son, St. George, Ont.  
Wesley, F. J. & Co., Toronto Junction, Ont.  
Garnder, N. R., Lyn, Ont.

**3766—WHIPS—Wire, Carpet.**

Goulette, O. V., Cananoque, Ont. *Advt. page 214.*  
Munro Bros., New Glasgow, N.S. *Advt. page 244.*  
Woodyatt, A. R. & Co., Guelph, Ont. *Advt. p. 207.*

**3767—WHIPS—Riding, Wagon, Whalebone,  
Rawhide, Rattan, Fancy, Farm, Coach,  
Carriage, Drivers'.**

Lay Whip Co. Branch, Rock Island, Que.  
Morgan Bros., Hamilton, Ont.  
Standard Whip Co., Toronto, Ont.  
Rock Island Whip Co., Rock Island, Que.

**3768—WHIP LASHES—Cotton.**

Lay Whip Co. Branch, Rock Island, Que.  
Brown, John E., Hamilton, Ont.  
Pett, James, Hamilton, Ont.  
Morgan Bros., Hamilton, Ont.

**3768 a—WHISKEY—“Club”.**

Walker, Hiram & Sons, Walkerville, Ont.

**3769—WHISKEY—Old Times, White Wheat.**

Seagram, Joseph E., Waterloo, Ont.

**3770—WHISKEY—Rye, Proof, High Wines.**

Walker, Hiram & Sons, Ltd., Walkerville, Ont.  
Hamilton Vinegar Works, Hamilton, Ont.  
Seagram, Joseph E., Waterloo, Ont.  
Corby, H., Belleville, Ont.  
McLaren, J. A., Perth, Ont.  
Spalding & Stewart, Perth, Ont.  
Gooderham & Worts Ltd., Toronto, Ont.  
Wiser, J. P. & Sons Ltd., Prescott, Ont.

**3771—WHISKS—Broom.**

Bryan, Thomas, London, Ont. *Advt. page 212.*  
Boeckh Charles & Sons, Toronto, Ont.  
Meakins & Co., Montreal, Que. *Advt. page 237.*

**3772 WHISTLES—Steam, Locomotive.**

Robb Engineering Co. Ltd., Amherst, N.S.  
*See inside front cover*  
Macdonald & Co. Ltd., Halifax, N.S. *Advt. page 256.*  
Morrison Jas. Brass Mfg Co., Toronto, Ont. *Advt. 157.*  
McAvity, T. & Sons, St. John, N.B. *Advt. page 153.*  
Mitchell, Robert & Co., Montreal, Que. *Advt. p. 213.*  
Garth & Co., Montreal, Que. *Advt. page 154.*

**3773—WHISTLES—(Cast Iron).**

Carrier, Laine & Co., Levis, Que, *Advt. page 150.*

**3774—WHISTLES—Toy.****3775—WICKS—(Cotton), Oil Stove, Candle,  
Lamp, Miners' Lamp, Ball.**

Hamilton Cotton Co., Hamilton, Ont. *Advt. p. 188.*

**3776—WICKING—Asbestos.**

Slater Asbestos Mfg Co., Montreal, Que. *Advt. 172.*

**3777—WIGS.**

Palmer's, Montreal, Que.  
Dorenwend Co. Ltd. (The), Toronto, Ont.

**3778—WINCHES—(Iron), Anchor, Steam, Hand, Horse=Power, Windlasses.**

Carrier, Laine & Co., Levis, Que. *Advt. page 150.*  
Miller Bros. & Toms, Montreal, Que. *Advt. page 197.*  
Kerr & Morgan, Montreal, Que. *Advt. page 220.*  
Macdonald Mfg Co., Halifax, N.S. *Advt. page 256.*  
Brown (G. & J.) Mfg Co., Belleville, Ont. *Advt. 198.*  
Robb Engineering Co. Ltd., Amherst, N. S.

*See inside front cover.*

Raney, Reid & Selby, Kingston, Ont.  
Burrell-Johnson Iron Co., Yarmouth, N.S.  
Matheson, I. & Co., New Glasgow, N.S. *Advt. 200.*

**3779—WINDERS—(Yarn) Hand, Power.**

Creelman Bros., Georgetown, Ont.

**3780—WINDERS—Bobbin.**

Tolton Bros., Guelph, Ont.

**3781—WINDLASSES—Ships, Chain, Rope, Hand.**

*See No. 3778.*

**3782—WINDERS—Car.**

Hobbs Mfg Co., London, Ont. *Advt. page 212.*  
Lyon, N. T., Toronto, Ont. *Advt. page 321.*

**3783—WINDOWS—(Ornamental) Memorial, Church, Stained.**

Lyon, N. T., Toronto, Ont. *Advt. page 321.*  
Hobbs Mfg Co., London, Ont. *Advt. page 212.*  
Elliott & Son, Toronto, Ont.  
McCausland, Jos. & Son, Toronto, Ont.

**3784—WINDVANES.**

*See No. 1806.*

**6785—WINE—(Claret) "Chateau Pelee".**

Pelee Island Wine Co., Brantford, Ont.

**3786—WINES—Medicinal.**

Stearns Fred'k & Co., Windsor, Ont. *See back cover.*  
Pelee Island Wine Co., Brantford, Ont.  
Hasking Wine Co. (The), Hamilton, Ont.

**3787—WINE—Of Cod Liver Oil with Peptonized Iron "Stearns".**

Stearns Fred'k & Co., Windsor, Ont. *See back cover.*

**3788—WINES—Pelee Island, Catawba (Sweet Dry) Isabella, Claret, Port, Sherry, Alicante, St. Augustine.**

Hamilton, J. T. & Co., Brantford, Ont.

**3789—WINES—High.**

*See Whiskey No. 3770.*

**3790—WINES—(Native) Brandy, Dry, Communion, Sweet.**

Gradot, E. Sandwich, Ont.  
Tournier, A. C., Sandwich, Ont.  
Bright, T. G. & Co., Toronto, Ont.  
Guindon, M., Sandwich, Ont.  
Hasking Wine Co. (The), Hamilton, Ont.  
Pequegnot, C. F., Sandwich, Ont.  
Hamilton, J. S. & Co., Brantford, Ont.

**3791—WINES—Medicated.**

Parke, Davis & Co. Ltd., Walkerville, Ont.

**3792—WIPERS—Machinery.**

Talbot, William & Co., Elora, Ont.

**3793—WIRE—Aluminum Brass.**

Ontario Tack Co., Hamilton, Ont. *Advt. page 180.*  
Greening Wire Co. Ltd. (The B.), Hamilton, Ont.

**3794—WIRE—(Iron) Fencing, Barb, Twist.**

Ontario Lead & Barb Wire Co. Ltd., Toronto, Ont. *Advt. page 177.*  
Dominion Wire Mfg Co., Montreal, Que. *Advt. 176.*  
Western Wire & Nail Co., London, Ont. *Advt. 177.*  
Safety Barb Wire Co., Toronto, Ont. *Advt. p. 180.*  
Greening Wire Co. Ltd. (The B.), Hamilton, Ont.

**3795—WIRE—(Iron) Baling, Electric Light, Telegraph, Telephone, Underground.**

Dominion Wire Mfg Co., Montreal, Que. *Advt. 176.*  
Montreal Rolling Mills Co., Montreal, Que. *Advt. 174.*

**3796—WIRE — (Bright) Annealed, Stove Pipe, Florists', Broom, Brush, Weaving, Bottling, Bonnet, Brass, Copper, Spring, Corset, Tinman's.**

Dominion Wire Mfg Co. Montreal, Que. *Advt. 176.*  
Ontario Tack Co., Hamilton, Ont. *Advt. page 180.*  
Montreal Rolling Mills Co., Montreal, Que. *Advt. page 174.*  
Canada Screw Co., Hamilton, Ont. *Advt. page 226.*

**3797—WIRE—Gold, Rolled Plate.**

Dominion Rolled Plate Co., Montreal, Que. *Advt. 236.*

**3798—WIRE—Silk Covered.**

Bell Telephone Co. (The), Montreal, Que.

**3799—WIRE—Silver.**

Dewdney, A. H. & Bros., Toronto, Ont.

**3800—WIRE—Fancy Fence, Ribbon, Galvanized, Clothes Line, Plain, Truss, Cable.**

*See No. 3795.*

**3801—WIRE WORK — Artistic, Builders', Diamond, Elevator, Ornamental.**

Dennis Wire & Iron Works, London, Ont. *Advt. 207.*  
Munro Bros., New Glasgow, N.S. *Advt. page 244.*  
Meadows, George B., Toronto, Ont.  
Major Mfg Co., Montreal, Que.

**3802—WIRES—(Electric) Connecting.**

Acadia Powder Co., Halifax, N.S. *Advt. page 240.*

**3803—WORKERS—Butter.**

Lancaster Machine Works, Lancaster, Ont. *Advt. 248.*  
Pearce, John S. & Co., London, Ont.

**3803a—WOOL STOCK.**

*See No. 3281.*

**3804—WORMS—(Copper) Brewers'.**

Coulter & Campbell, Toronto, Ont. *Advt. page 201.*

**3805—WORMS—Gearing.**

Carrier, Laine & Co., Levis, Que. *Advt. page 150.*  
Brush, George, Montreal, Que.  
Fleck, Alex., jr., Ottawa, Ont. *Advt. page 252.*  
Bertram, John & Sons, Dundas, Ont. *Advt. page 161.*  
Goldie & McCulloch Co., Galt, Ont. *Advt. page 159.*  
Wilson, J. C. & Co., Glenora, Ont.

**3806—WOOD—Spool (prepared).**

Palbert, D., Lake Bouchette, Que., (Lk. St. John R.R.)

**3807—WOOD—Cord, Slab.**

Pembroke Lumber Co., Pembroke, Ont. *Advt. 216.*  
McLean & Son, Wingham, Ont.

Goodhue Bros., Danville, Que. *Advt. page 236.*

**3808—WOOD—(Bundled), Kindling.**

Breakey, John, Chaudière Mills, Que.  
Batchelder, R. C. & Co., Hawkesbury, Ont.

**3809—WOOD—Bent.**

Hoers, F. W. Sons, Hamilton, Ont.  
Victoria Wheel Works, Galt, Ont.  
Canada Wheel Works, Merritton, Ont.  
Loughead, J. S. & Co., Sarnia, Ont.  
McVean, O. & W., Dresden, Ont.  
Crawford, W. C., Tilbury Centre, Ont.

**3810—WOOD—(Pulp), Prepared, Spruce, Poplar.**

King Bros., Quebec, Que. *Advt. page 240.*  
Price, H. M. & Co., Quebec, Que. *Advt. page 223.*  
Goodhue Bros., Danville, Que. *Advt. page 236.*  
Pembroke Lumber Co., Pembroke, Ont. *Advt. p. 216.*  
Lemay, Alphonse, Portneuf, Que.  
Ross, W. H., Sherbrooke, Que.  
Hodge & Walley, Sherbrooke, Que.  
MacLeay, A. & Riddle Bros., Danville, Que.  
Stearns, L. A., Magog, Que.

**3811—WOOD—(Pulp), In the Rough.**

Palmer, J. S., Sherbrooke, Que. *Advt. page 228.*  
Curtis, Warren, Three Rivers, Que.  
Champoux, John, D'Israeli, Que.  
Flood, N., Quebec, Que.  
Lyons, A., Blackwater Junction, Ont.  
Church, Mitchell & Fee, Mitchell Station, Que.  
Merrick, S. S., Charleton Place, Ont.  
Beaudoin, Theo., Broughton, Que.  
Beaudoin, Louis, Broughton, Que.  
Mason, William & Sons, Ottawa, Ont.  
Fish, R. Y., Waterloo, Ont.  
Godbout, Joseph, St. George de Windsor, Que.  
Wortman, W. F., Salisbury, N. B.  
Dupont, Louis, St. Jean de Neuville, Que.  
Dupont, Louis, St. Casimir, Que.  
McHart, H., Sheet Harbor, Halifax Co. N. S.

**3812—WOODS—Whiffletree, Neck Yoke, Singletree.**

Chatham Mfg Co. Ltd., Chatham, Ont. *Advt. p. 245.*  
Snider, Jesse, Hagersville, Ont.  
Hore's F. W. Sons, Hamilton, Ont.  
Canada Wheel Works, Merritton, Ont.  
Strathroy Mfg Co., Strathroy, Ont.  
Still, J. H., St. Thomas, Ont.  
McVean, O. & W., Dresden, Ont.

**3813—WOODWORK—Architectural, Ornamental.**

Otterville Mfg Co. Ltd., Otterville, Ont. *Advt. 259.*  
Paquet & Godbout, St. Hyacinthe, Que.  
Rathbun Co. (The), Deseronto, Ont. *Advt. page 162.*  
Rhodes, Curry & Co., Amherst, N. S. *Advt. p. 158.*  
Morin, L. P., St. Hyacinthe, Que.

**3814—WOOL—Mineral.**

Eureka Mineral Wool & Asbestos Co., Toronto, Ont. *Advt. page 242.*  
Canadian Mineral Wool Co. Ltd., Toronto, Ont.

**3815—WRAPS—Knee.**

Toronto Carpet Mfg Co., Toronto, Ont. *Advt. p. 186.*  
Waterloo Woolen Co. Ltd., Waterloo, Ont.

**3816—WRENCH—"Houghton's Seat Lock," Keylock.**

Paris Tool Mfg Co. Ltd. (The), Paris, Ont.

**3817—WRENCHES—Reamer, Adjustable Reamer**

Jardine, A. B. & Co., Hespeler, Ont. *Advt. page 217.*  
Butterfield & Co., Rock Island, Que.

**3818—WRENCHES—Bicycle.**

Goold Bicycle Co. Ltd., Brantford, Ont. *Advt. p. 220.*

**3819—WRENCHES—Buggy, Knife Handle.**

Whitman & Barnes Mfg Co., St. Catharines, Ont.

**3820—WRENCHES—Machinists', Pipe, Nut.**

Smart (Jas.), Mfg Co., Brockville, Ont. *Advt. p. 178.*  
Butterfield & Co., Rock Island, Que.  
Robb Engineering Co. Ltd., Amherst, N.S.

*See inside front cover.*

Paris Tool Mfg Co. Ltd. (The), Paris, Ont.

**3821—WRENCHES—(Malleable), Carriage.**

Malleable Iron Co., Montreal, Que.  
Burrow, Stewart & Milne, Hamilton, Ont.  
Frost, W. H., Smith's Falls, Ont.  
Kyle, P., Merrickville, Ont.

**3822—WRENCHES—"S", Alligator, Key, Monkey, Railroad Track, Square, Spanner.**

Smart, (Jas.) Mfg Co., Brockville, Ont. *Advt. p. 178.*  
Whitman & Barnes Mfg Co., St. Catharines, Ont.

**3823—WRINGERS—(Power) Cloth, Hosiery.**

Karch, H. W., Hespeler, Ont.

**3824—WRINGERS—Clothes, Centrifugal.**

Myers, W. F. & J. W., St. John, N. B. *Advt. p. 163.*  
Mac Machine Co., Belleville, Ont. *Advt. page 194.*

**3825—WRINGERS—(Hand)Clothes, "Stands"**

Dowswell Bros. & Co., Hamilton, Ont. *Advt. p. 243.*  
Brockville Wringer Co., (The), Brockville, Ont.  
Cowan, O. D., Gananoque, Ont. *Advt. page 233.*  
Connor, J. H., Ottawa, Ont.

**3826—YACHTS—Steam.**

Carrier, Laine & Co., Levis, Que. *Advt. page 150.*  
Bertram Engine Works Co., Toronto, Ont. *Advt. 161.*  
Knapp, A. C., Kingston, Ont. *Advt. page 229.*  
Gillies, John & Co., Carleton Place, Ont.

**3827—YACHTS—Sailing.**

Knapp, A. C., Kingston, Ont. *Advt. page 229.*  
\*Gilbert, N., Boat Co., Brockville, Ont. *Advt. p. 254.*

**3828—YARDSTICKS.**

Magee Bros., London, Ont.

**3829—YARN—Tarred Lath.**

Canada Jute Co., Montreal, Que. *Advt. page 225.*  
Kingston Cardage Co., Kingston, Ont.

**3830—YARN—(Spun) Housline, Hambroline, Marline, Russian Hemp.**

Canada Jute Co., Montreal, Que. *Advt. page 225.*

Perrine, M. B. & Co., Doon, Ont. *Advt. page 181.*  
 Overcourt Twine Mills Co., Toronto, Ont. *Advt. 184.*

**3831—YARNS—(Cotton) Colored, Carpet, Hosiery, White, Knitting.**

Hamilton Cotton Co., Hamilton, Ont. *Advt. p. 188.*  
 Parks, William & Son Ltd., St. John, N.B. *Advt. 233.*  
 Canadian Colored Cotton Mills Co. Ltd., and Dominion Cotton Mills Co. Ltd., Montreal. *Advt. p. 181.*

**3832—YARNS—Silk.**

Belding, Paul & Co., Montreal, Que. *Advt. p. 183.*  
 Corticelli Silk Co. Ltd., St. Johns, Que. *Advt. p. 182.*

**3833—YARNS—(Cotton) Electric Wire.**

Parks, William & Son, St. John, N. B. *Advt. p. 233.*

**3834—YARNS—(Woolen) Carpet.**

Hamelin & Ayers, Lachute Mills, Que. *Advt. p. 188.*  
 Turnbull, C. (The) Co., Galt, Ont. *Advt. page 203.*  
 Waterhouse, Thos., Palmerston, Ont.  
 Oxford Mfg Co., Oxford, N. S.  
 Grindrod, A. L. & Co., Sherbrooke, Que.  
 Humphrey, John A. & Son, Moncton, N. B.  
 Yarmouth Woolen Mills Co., Yarmouth, N. S.  
 Hodge, William, Cornwall, Ont.  
 Schofield Woolen Co., Oshawa, Ont.

**3835—YARNS—(Woolen) Knitting, Hosiery, Worsted, Fingering.**

Turnbull, C., Co. Ltd., Galt, Ont. *Advt. page 203.*

Hamelin & Ayers, Lachute Mills, Que. *Advt. p. 188.*  
 Slingsby Mfg Co. Ltd., Brantford, Ont.  
 Paton Mfg Co., Sherbrooke, Que.  
 Forbes, R., Co. Ltd. (The), Hespeler, Ont.  
 Almonte Blanket Mills, Almonte, Ont.  
 Talbot, Cockcroft & Harvey, Elora, Ont.  
 McLean, James, Pembroke, Ont.  
 Schofield Woolen Co., Oshawa, Ont.  
 Rosamond Woolen Co., Almonte, Ont.  
 Humphrey, John A. & Son, Moncton, N.B.  
 Hodge William, Cornwall, Ont.

**3836—YEAST—Compressed.**

Fleishmann & Co., Toronto, Ont.

**3837—YOKES—Axle.**

Frost, W. H., Smith's Falls, Ont.

**3838—YOKES—Neck.**

Chatham Mfg Co., Chatham, Ont. *Advt. page 245.*

**3839—ZINC—Seives, Perforated.**

Greening & Sons, Chatham, Ont.

**3840—ZINC—White.**

Howe, William, Ottawa, Ont. *Advt. page 201.*  
 Ramsay, A. & Son, Montreal, Que. *Advt. page 211.*  
 Henderson & Potts, Halifax, N.S.  
 Canada Paint Co., Montreal, Que. *Advt. page 221.*  
 McArthur, Corneille & Co., Montreal, Que. *Advt. 221.*

# NEWSPAPERS

## Representative List of Canadian Publications.

**3841—ONTARIO.**

Almonte—Gazette,	(W.)
Amherstburg—Echo,	(W.)
Aylmer—Express,	(W.)
Barrie—Northern Advance,	(W.)
Belleville—Sun,	(D. & W.) <i>Advt. page 261.</i>
Berlin—Record,	(D. & W.) <i>Advt. page 261.</i>
Brantford—Expositor,	(D. & W.) <i>Advt. page 261.</i>
Brockville—Recorder,	(D. & W.)
Chatham—Planet,	(D. & W.)
Cornwall—Standard,	(W.) <i>Advt. page 261.</i>
Galt—Reformer,	(D. & W.) <i>Advt. page 261.</i>
Goderich—Signal,	(D. & W.)
Guelph—Herald,	(D. & W.)
Hamilton—Herald,	(D.) <i>Advt. page 261.</i>
“—Times,	(D. & W.) <i>Advt. page 261.</i>
Ingersoll—Chronicle,	(W.) <i>Advt. page 261.</i>
Kingston—News,	(D. & W.)
“—Whig,	(D. & W.)
Lindsay—Post,	(D. & W.) <i>Advt. page 261.</i>
“—Warder,	(W.) <i>Advt. page 261.</i>
London—Advertiser,	(D. & W.) <i>Advt. page 261.</i>
Napanee—Beaver,	(W.)

Newmarket—Era,	(W.)
Orangeville—Post,	(W.)
Orillia—Times,	(W.)
Oshawa—Reformer,	(W.)
Ottawa—Citizen,	(D. & S.-W.)
Pembroke—Standard,	(W.) <i>Advt. page 261.</i>
Perth—Courier,	(W.)
Peterboro—Examiner,	(D. & W.) <i>Advt. page. 261.</i>
St. Catharines—Star,	(D. & W.)
St. Mary's—Argus,	(W.) <i>Advt. page 261.</i>
St. Thomas—Journal,	(D. & W.)
Sarnia—Post,	(D. & W.)
Stratford—Beacon,	(D. & W.)
Toronto—Globe,	(D. & W.)
“—Mail & Empire,	(D. & W.)
“—News,	(D.) <i>Advt. page 261.</i>
“—Star,	(D.) <i>Advt. page 262.</i>
“—Canada Baptist,	(W.)
“—Canada Presbyterian,	(W.) <i>Advt. page 261.</i>
“—Canadian Churchman,	(W.)
“—Canadian Manufacturer, (S. M.)	<i>Advt. page 260.</i>
“—Christian Guardian,	(W.)
“—Monetary Times,	(W.) <i>Advt. page 262.</i>
“—Presbyterian Review,	(W.)

Toronto—Saturday Night, (W.)  
 Trenton—Advocate, (W.) *Advt. page 262.*  
 Waterloo—Chronicle, (W.)  
 Welland—Telegraph, (W.)  
 Windsor—Record, (D. & W.)  
 Woodstock—Sentinel Review, (D. & W.)

### QUEBEC.

Cookshire—Chronicle, (W.)  
 Levis—Quotidien, (D. & W.)  
 Montreal—Gazette, (D. & W.)  
 “ —Herald, (D. & W.)  
 “ —Star, (D. & W.)  
 “ —Witness, (D. & W.)  
 “ —Monde, (D. & W.)  
 “ —Patrie, (D. & W.)  
 “ —Presse, (D. & W.)  
 “ —Prix Courant, (W.)  
 Quebec—Chronicle, (D. & W.)  
 “ —Mercury, (D.) *Advt. page 262.*  
 “ —Evenement, (D.) *Advt. page 262.*  
 Rock Island—Stanstead Journal, (W.) *Advt. page 262.*  
 St. Hyacinthe—Union, (D.)  
 St. John's—Canada Francais, (W.) *Advt. page 262.*  
 “ —News, (W.)  
 Sherbrooke—Examiner, (W.) *Advt. page 262.*  
 “ —Gazette, (W.) *Advt. page 262.*  
 Three Rivers—Trifluvien, (S. W.)

### NEW BRUNSWICK.

Fredericton—Gleaner, (D. & W.) *Advt. page 262.*

Moncton—Transcript, (D. & W.) *Advt. page 262.*  
 St. John—Sun, (D. & W.) *Advt. page 262.*  
 “ —Telegraph, (D. & W.) *Advt. page 262.*  
 Woodstock—Carleton Sentinel, (W.) *Advt. page 262.*

### NOVA SCOTIA.

Amherst—Press, (D. & S.-W.)  
 Halifax—Chronicle, (D. & W.)  
 “ —Herald, (D., & W.)  
 Truro—News, (D. & W.)  
 Yarmouth—Times, (S.-W.) *Advt. page 262.*

### PRINCE ED. ISLAND.

Charlottetown—Guardian, (D. & W.)  
 Summerside—Journal, (W.)

### MANITOBA.

Brandon—Times, (W.)  
 Portage La Prairie—Liberal, (S.-W.)  
 Winnipeg—Free Press, (D. & W.)  
 “ —Tribune, (D. & W.)

### NORTH WEST TERRITORIES.

Calgary—Herald, (D. & W.)  
 Regina—Leader, (W.)

### BRITISH COLUMBIA.

Nanaimo—Free Press, (D. & S.-W.)  
 New Westminster—Columbian, (D. & W.)  
 Vancouver—World, (D. & W.)  
 Victoria—Colonist, (D. & W.)

### 3842—HOPS.

Hudgin, A. A., Picton, Ont.  
 Moore, George, Waterloo, Ont.  
 McCuaig, Cheney & Co., Vankleekhill, Ont.  
 Walker & Sons, Walkerville, Ont.

### 3843—WOOL—Tub, Pulled.

Appeley, A. B., Peterboro, Ont.  
 Biggar, William & Son, Galt, Ont.  
 Cowards, S. M., Mitchell, Ont.  
 Cram, John F., Carleton Place, Ont.  
 Funnell, John, Trenton, Ont.  
 Fulton, Harlan, Halifax, N.S.  
 Galibert, C. & Son, Montreal, Que.  
 Hallam, John, Toronto, Ont.  
 Jago, W. H. & Son, Rockwood, Ont.  
 Johnson, J. M., St. John, N.B.  
 Kimble, John & Son, St. John, N.B. *Advt. No. 3857.*  
 Leadlay, E. & Co., Toronto, Ont.  
 Megeney, R., Halifax, Ont.  
 Mitchell, T. G., Watford, Ont.  
 Munroe, D., Carleton Place, Ont.  
 Turgeon, E., Quebec, Que.  
 McKay & Co., Orillia, Ont.

### 3844—WOOL—Merchant.

Annett, James, Watford, Ont.  
 Baker & McColl, Ayr, Ont.  
 Baker & Vanstone, Brussels, Ont.  
 Blackburn, J. D., Chatham, Ont.  
 Bogart, N. J., Chatham, Ont.  
 Berryman, Robert, Hamilton, Ont.  
 Brook, B. F. & Son, Listowel, Ont.

Butler, James, Strathroy, Ont.  
 Carter, G. Son & Co., St. Mary's, Ont.  
 Colby, C. D., Chatham, Ont.  
 Fisher, T. S., Toronto, Ont.  
 Fraser & Son, Pembroke, Ont.  
 Hallam, John, Toronto, Ont.  
 Hughes, D. W., Toronto, Ont.  
 Laing, Alex., Wyoming, Ont.  
 Lloyd & Scully, Owen Sound, Ont.  
 Long & Bisby, Hamilton, Ont.  
 Long, T. & Bros., Collingwood, Ont.  
 Lund, R. J., Woodstock, Ont.  
 McGillivray, William, Smith's Falls, Ont.  
 McNaughton, Walker & Co., Chatham, Ont.  
 Moore, George, Waterloo, Ont.  
 Robson, M., Ayr, Ont.  
 Sadler, Dundas & Flavelle Co., Lindsay, Ont.  
 Smith, C., Wallaceburg, Ont.  
 Smith, Bros., Renfrew, Ont.  
 Taylor, T. H. Co. Ltd. (The), Chatham, Ont.  
 Tiche & Stringer, Chatham, Ont.  
 Thomson, Walter, Mitchell, Ont.  
 Reiner, J. G., Wellesley, Ont.

### 3845—APPLES.

Cantlon, David, Clinton, Ont.  
 De Laport, Toronto, Ont. *Advt. No. 3850.*  
 Hogg Bros., Oakwood, Ont.  
 Ingersoll, Hunt & Co., Thornbury, Ont.  
 Miller & Co., Trenton, Ont.  
 Mahler, C., Delaware, Ont.  
 Waterloo Produce Co., Waterloo, Ont.  
 Zinkann, J. N., Wellesley, Ont.



# Hardware Merchants.



3846

## BRITISH COLUMBIA.

Archer, F. E., Kaslo  
Armstrong, W. J., Vernon  
Bibby, John, Barkerville  
Brown, R. A. & Co., Victoria  
Byers, H., Three Forks  
Byers, H., Kaslo  
Cawley, S. A. & Co., Chilliwack  
Coupland, Jos., Vancouver  
Cunningham, M. A. (Mrs. J.), New Westminster  
Dunn, Thos. & Co., Ltd. Vancouver  
Ferris, W. F., Chilliwack  
Godfrey, A., New Westminster  
Goudron, M. (Mrs. J.), Vancouver  
Langton, W. M., Nanaimo

Langton, W. M. Victoria  
McGregor, A. & Son, Victoria  
McLennan McFeely & Co., Lim., Vancouver  
Martin Bros., Vernon  
Marvin & Tilton, Victoria  
Nicholles & Renouf, Ltd., Victoria  
Nott, R. J., Victoria  
Prior, E. G. & Co., Ltd., Victoria  
Shirley & Hoy, New Westminster  
Shore, Sidney, Victoria  
Travers, J., Rossland  
Tye, T. H. & Co., Victoria  
Vair, James, Kamloops  
Van Houten, W. J., Nanaimo

## MANITOBA.

Abremovich, H., Winnipeg  
Anderson, C. E. (Mrs. C. V.), Oak Lake  
Ashdown, A. L., Portage La Prairie  
Ashdown, Geo., Morden  
Ashdown, J. H., Winnipeg  
Bagshawe, Walter, Minnedosa  
Bambridge, J. Y. & Co., Souris  
Baskerville, C. A. & Co., Winnipeg  
Beyers, Henry, McGregor Station  
Boyd, John F., Minnedosa  
Bridgett, Wm., Pipestone  
Brown, A. P., Morden  
Brown, C., Hilton  
Brown, H. W., Carberry  
Brown & Mitchell, Brandon  
Buettner Bros., Hartney  
Birbeck Jos., Boissevain  
Batchart & Somersall, Carman  
Cadham, John O., Portage La Prairie  
Campbell Bros., Winnipeg  
Chalmers Bros. & Bethune, Manitou and Pilot Mound  
Clegghorn, J. G. T., Winnipeg  
Cochrane, W. T., Oak River  
Craig, W. J. & Co., Winnipeg  
Dandy, J. F., Pierson  
Doig, A., Birtle  
Doig, A., Glenboro  
Doig, Wm., Russell  
Edwards, W. J., Reston  
Falconer & Martin, Deloraine  
Fisher, R. B., Gretna  
Frame & Miller, Vildon  
Fryier, H. B., McGregor Station  
Fullbrook, J. W., Stonewall  
Graham, C. W., Winnipeg  
Graham, D. B., Pilot Mound

Greenshaw, C. H., Shoal Lake  
Guilbault, E., St. Boniface  
Hamilton, B. R. & Co., Neepawa  
Hamilton, Robt. G., Carman  
Hamilton, S. A. (Mrs. Robt.), Emerson  
Hunter, Helen, Hartney  
Johnson & Co., Brandon  
Knaus, Wilhelmina, Selkirk West  
Laloan, C. W., Carberry  
Lamont, D. C., Neepawa  
Lawrence, W. M., Winnipeg  
Lawrence & Campbell, Miami  
Liddle, Thos., Killarney  
London, Mrs. W. P., Ninga  
McCrea & McLean, Gladstone  
McDougall & Co., Neepawa  
McGregor, D., Shoal Lake  
McLean, Robt., Lake Dauphin  
McLennan, C. W., Melita  
Mawhinney, Edward, Holland  
Meikle, Thos. B., Carman  
Millar, T. & W., Portage La Prairie  
Miller, Morse & Co., Winnipeg  
Montgomery, Weston, Stonewall  
Moody & Sutherland, Selkirk West  
Morse, H. V., Melita  
Murry & Mitchell, Souris  
Neithercutt, R. J., Wawanesa  
Parsons, Thos. J., Oak Lake  
Phillips & Co., Cartwright  
Phillips & Co., Killarney  
Phillips, R. Co. (The), Dominion City  
Pool, T. E., Baldur  
Rattray & Skelding, Pipestone  
Reimer, H. W., Steinbach  
Renwick, Wm., Arden

## HARDWARE MERCHANTS.

### MANITOBA.—Continued.

**ROBERTSON, JAS. & CO., Brandon,**  
Dealers in Harness, Carriage Stock, Paints, Oils,  
and Glass, Stoves and Hollow Ware, &c.

Robertson, Jas. & Co., Winnipeg  
Rollins, R., Crystal City  
Sawyer, O., Oak River  
Shilington & Co., Stockton  
Sparks, F. F., Balmont  
Strube, J. P., Trehern  
Steed, H. W., Winnipeg  
Taylor & Black, Minnedosa

Titus & Son, Napinka  
Wasdale, Jos., Winnipeg  
Weir, F. W. & Co., Winnipeg  
Wells, J. L. & Co., Winnipeg  
White, James, Rapid City  
Williams Bros., Gladstone

**WOOD, GEO. D. & CO., Winnipeg,**  
Wholesale Hardware Merchants.

Wyatt, R., Winnipeg  
Young, Jos., Hartney

## NORTH-WEST TERRITORIES.

Agnew, T. J., Prince Albert  
Baker, A. E. & Co., Moose Jaw  
Bradford, T., Saltcoals  
Brass, J., Moose Jaw  
Campbell, W. R., Moose Jaw  
Chapman, W. D., Calgary  
Dillon & Co., Fort Qu'Appelle  
Edmonton Hardware Co., Edmonton  
Ferguson, J. J., Edmonton  
Foulds, A. H., Carnduff  
Heaslip, J. J., Alameda  
Hinton, T. H., Pincher Creek  
Johnstone, W., Qu'Appelle  
Kerr, J. A., Regina

Lawrence, J., Lethbridge  
McBride A. & Co., Calgary  
McCaltum & Wallace, Wetaskewin  
McGee, G., Esteven  
McLean & Co., Edmonton  
Miller & Co., Moosomin  
Reid, A., Lacombe  
Ross Bros., Edmonton  
Shannon, S., Regina  
Smith, A., Moosomin  
Smith & Ferguson Co. (The), Regina  
Thompson, A. G., Wolseley  
Walker Bros., Olds

## NEW BRUNSWICK.

Baskin, W. D., St. John  
Beverly, F., St. John  
Casman, H. S., St. John  
Chase, Barker & Co., St. Stephen  
Chestnut, R. & Son, Fredericton  
Crawford, Henry, St. John  
DeBoo, Jacob, Sussex  
DeWolf, Andrew, St. Stephen  
DeWolf & Dinsmore, St. Stephen  
Dibblee, W. F. & Son, Woodstock  
Everett, Z. R., Fredericton  
Farren, Edward S., St. George  
Forster, W. D., St. Andrews  
Goggin, Jos. R., Chatham  
Hayward, S. & Co., St. John  
Horncastle, J. & Co., St. John  
Kerr & Robertson, St. John  
Legere, Clement M., Memramcook  
Lindsay, J. R. & R. J., Woodstock  
Jones, A. E., Woodstock  
Horton, H. & Son, St. John

**McAVITY & Sons, T., St. John,**  
Metal and Hardware Merchants.

McMonagle, M., St. Andrews  
Marquis, G. R., Chatham  
Martin, J. H. & Co., St. John  
Neill, James S., Fredericton  
Nicoll & Co., Chatham  
Pratt, H. J., St. John  
Regan, Daniel, St. Stephen  
Rowan, A. M., St. John  
Searle, Geo. P., Chatham  
Selfridge, R. J., St. John  
Steeves, Jordan, Hillsboro  
Stickney, G. H., St. Andrews  
Strathie, Jno., Harbour Grace  
Sumner & Co., Moncton

**THORNE, W. H. & CO., Ltd., St. John,**  
Wholesale Metals, Hardware,  
Paints, Oils, Glass.

Todd Bros., St. Stephen  
Wilson, John E., St. John  
Winter, F. W., Moncton  
Young, F. A., St. John

## NOVA SCOTIA.

Adams, E. D., Halifax  
 Archibald & Sweet, Antigonish  
 Arthur, W. B. & Co., Halifax  
 Austen, J. W., Halifax  
 Bell, A. W., Halifax  
 Bent & Cohoon, New Glasgow  
 Bill, Jos. S., Lockeport  
 Bromley, John, Halifax  
 Calkin, Geo. E., Kentville  
 Calkin, T. P. & Co., Kentville  
 Carson, Adam, Picton  
 Carson, William, Picton  
 Clish, Joseph, Stellarton  
 Cooper, J. & Son, North Sydney  
 Cragg Bros. & Co., Halifax  
 Cromwell, M. O., Halifax  
 Crowell, R. A. Bridgetown  
 Cromwell, Samuel & Co., Yarmouth  
 Davidson, Eyra, Halifax  
 Dawson, R. & Son, Picton  
 Dimmock, Wm., Windsor  
 Donkin, Levy B., Springhill  
 Dorman, W., Canning  
 Douglas & Co., Amherst  
 Dunsmore, Wm., Oxford  
 Elliott, H. E., Pugwash  
 Franklyn, J. L., Wolfville  
 Fuller, H. H. & Co., Halifax  
 Gibson, W. J., Parsboro  
 Grant, A. J. & Co., Halifax  
 Grant, Oxley & Co., Halifax  
 Gullivan, Lalia, Middleton  
 Hanson, T. D., Truro  
 Hardware & Stationery Co., North Sydney  
 Hood, J. Andrew, Westville

Illsley & Harvey, Port William  
 Knight & Black, Amherst  
 Langille, A., Mahone Bay  
 McGregor & Co., New Glasgow  
 McGregor, Hugh, Westville  
 McLennan, Fred., Picton  
 Magnus & Lownds, Halifax  
 Melvin & Co., Halifax  
 Mock, I. N. & Co., Liverpool  
 Parker, John M., Berwick  
 Patterson, Geo., Windsor  
 Pineo & Clark, Berwick  
 Powers, F., Lunenburg  
 Powers, Jas. T. & Co., Bridgewater  
 Robertson, Wm., Halifax  
 Rogers, W. L., Yarmouth  
 Russell, N. & Co., Dartmouth  
 Simonds, James & Co., Dartmouth  
 Sleep, Lewis W., Wolfville  
 Smith, Geo. E. & Co., Halifax  
 Spinney, Edgar K., Yarmouth  
 Stairs, John & Co., Halifax  
 Stairs, Wm. Son & Morrow, Halifax  
 Thompson, A. C. & Co., North Sydney  
 Tremaine, J. H., Truro  
 Turner, R. J., Truro  
 Walker, A. J. & Sons, Truro  
 Walker & Hanson, Truro  
 Walsh, P. (The) Hardware Co., Halifax  
 Weatherbee, Uriel J., Spring Hill  
 West, H. A. & Co., Annapolis  
 White, John & Co., Halifax  
 Wilcox Bros., Windsor  
 Wilson, J. E., Halifax

## ONTARIO.

Accomere, F. & Co., Collingwood  
 Acheson, James, St. Thomas  
 Ackerman & Rorke, Norwood  
 Acton, J. A., Eganville  
 Adam, J. D., Tavistock  
 Agar, Andrew B., Lion's Head  
 Aherns & Gruetzner, Hanover

### **A**IKENHEAD HARDWARE CO., Toronto.

**Builders and General Hardware,**

**Machinists' and Carpenters' Tools, Bar Iron and Steel,  
 Fine Table and Pocket Cutlery.**

Allan, G., Burlington  
 Allen, Jas., Ailsa Craig  
 Allan, J. A. W. & Co., Newmarket  
 Allen, J. W., Toronto  
 Alliss, J. H., Essex  
 Ames, G. P., Wiarton  
 Anderson Bros., Moorefield  
 Anderson, P. J., Cannington  
 Anderson, Wallace, Simcoe  
 Andrew, George, Oakville  
 Appleyard, R. H., Humberston  
 Arnold, F. J., Granton  
 Aubin, O., Sturgeon Falls

Aulph, Isaac B., Bracebridge  
 Bair, Alexander, Cayuga  
 Barsalow & Co., Brockville  
 Bartlett, J. W., London  
 Batty, T. & Co., Norwich  
 Beattie, Thos. J., Comber  
 Beek, C., Sault Ste. Marie  
 Bell, George M., Hamilton  
 Bell, W. J., Beeton  
 Bennett, Frank A., Tesselton  
 Bennett, I. W. & Son, Gananoque  
 Bertram, P., Hamilton  
 Bertram & Co., Toronto  
 Best, Henry, Peterboro  
 Bingham, R. E. & Co., Stayner  
 Binns, George A., Newmarket

### **B**IRKETT, THOS., Ottawa,

**General Hardware, Steel Iron,**

**Coals, Rope, Chains, &c.**

**Builders' & General Shelf Hardware, Glass, Paints, Oils, Putty**

Bishop, H. & Son, Exeter  
 Bishop, John & Son, Brantford  
 Blain, R., Brampton

HARDWARE MERCHANTS.

ONTARIO.—Continued.

Bogart & Carter, Picton  
Boles, Frank C., Ingersoll  
Bond, J. M. & Co., Guelph  
Bonnett & Bowyer, Listowel  
Bottum, A. E., Bobcaygeon  
Boulter & Gilmour, Hamilton  
Bowditch, Geo. & Co., Woodstock

**BOWMAN, KENNEDY & CO., London,**  
Wholesale dealers in Hardware and Sporting  
Goods, Coal, Glass, Paints, Oils, &c.

Boyd, C. E., Norwich  
Boyle & Son, Napanee  
Bradfield Bros. & Co., Morrisburg  
Bradfield, R. H. & Co., Morrisburg  
Bradt, A., Port Rowan  
Braund, Eli, Aurora  
Braund, William, Port Hope  
Bricker Hardware Co., Listowel  
Bright & Thayer, Brampton  
Bristone, W., Rodney  
Brock, Robert, Bellefontain  
Bruce, R. J., Port Perry  
Buchanan, J., Galt  
Buckham, Andrew G., Brampton  
Buckley, P., Paris  
Bungay, L. F., Norwich  
Butchart, William, Meaford  
Butler, Arthur, J., Arnprior  
Butler, W. G., Perth  
Butterworth, & Co., Ottawa  
Cain, J. J., Alliston  
Calder, George, Holstein  
Callaghan, D. J., Elmvale  
Calvin & Fraser, Galt  
Cameron & Cameron, Beaverton  
Campbell, F. A., Mitchell  
Campbell, R., Middlemiss  
Campbell & Granger, Wheatley  
Campbell & Spence, Kirkfield  
Carpenter & Ramsay, Hamilton  
Carscadden, T. J., Thornbury  
Carscallen Bros., Dresden  
Carter, D., Chesterville  
Carter, H. R., Chesley  
Casement, R. R. & Co., Madoc  
Casement, W. H., Lakefield  
Caslor, John, Toronto  
Chalmers, Jas., jr., St. Marys  
Chambers, Hiram, Springfield  
Chapman, Annie, Hastings  
Chappel, H. C., Hamilton  
Chipman, John, Drumbo  
Chown, A. & Co., Kingston  
Chown, Chas. D., Kingston  
Chown, S. C., Trenton  
Cinnamon, D., Oshawa  
Clarke, G. H. & Co., Niagara Falls  
Clark, J. M., Smith's Falls  
Clark, W. H., Port Perry  
Clegg, J. & Co., Wingham  
Cleland, James & Son, Meaford  
Cleland & Gray, Listowel  
Clement & Co., Bolton  
Clements, W. B., Milton  
Clifton, W. B., Alliston  
Cline, J. A. & Co., Wingham

Clunis, J. R., Galt  
Cochrane, F., Sudbury  
Codville, Jos., Woodstock  
Cole, E. A., Carleton Place  
Cole & McMurray, Niagara Falls  
Congdon & Marshall, Dunnville  
Conn, Wesley, Aylmer  
Connor & Richardson, Madoc  
Conrad, Jacob, Waterloo  
Conroy, P. A., Cornwall  
Corbett, John, Kingston  
Cowan Bros., London  
Coy Bros., St. Catharines  
Craddock, William, Warton  
Crapper, Frederick, Toronto  
Crawford, R., Arkona  
Crawford, W. C., Tilbury Centre  
Crosby & Hussey, High Gate  
Cross & Granger, Whitby  
Cullen, D. S., Drumbo  
Cunningham, M., Streetville  
Curle, George, Mildmay  
Cusack, William, Wallacetown  
Dagneau & King, Chatham  
Dalton & Strange, Kingston  
Davey, Richard B., Kincardine  
Davidson & Co., Goderich  
Davis, Charles, Schomberg  
Davis, G. N., Goderich  
Davis, Thomas W., Ripley  
Davis & Rowland, Clinton  
Dempsey Bros., Marmora  
Devine & McGarry, Renfrew  
Dewar Bros., Milton  
Dewar, J. S., Clifford  
Dickinson, Henry, Delhi  
Dillon, R. J., Oshawa  
Dingwall & Rose, Port Hope  
Dippel & Noecker, Drayton

**DOBBIE, A. G. & CO., Brockville,**  
Dealers in Shelf and Heavy Hardware,  
Wholesale and Retail.

Paints, Oils, Putty, Window Glass, Cutlery, Plated Ware.  
Carriage Goods a specialty.

Dobbyn Bros., Newbury  
Dougherty & Silvester, Stouffville  
Drew, M. C., Burk's Falls  
Driffill, Thos. & Sons, Bradford  
Drumm, Jacob, Neustadt  
Duffield, J. & Son, Wingham

**DUNLOP & COMPANY, Pembroke,**  
Shelf and Heavy Hardware,

Lumberman's Supplies a specialty.  
Manufacturers of Hand Made Axes.

Dunn, R. & Co., Port Hope  
Duston & Hoar, Bowmanville  
Ecclestone & Ramsay, Bracebridge  
Edwards, J. G. & Co., Lindsay  
Elliott, Thomas, Perth  
Elliott & Phin, Brantford  
Ellis, A. D., Simcoe  
Ellis, E. H., Gananoque

HARDWARE MERCHANTS.

ONTARIO.—Continued.

Emerson & Hawkins, Oshawa  
 Emery, W., Toronto  
 Evans, Geo., Bright  
 Evans, George, Toronto  
 Fair, R., Toronto  
 Falconer, W. J., Palmerston  
 Farmer, Henry, Toronto  
 Farwell & Co., Sault Ste. Marie  
 Fear, J. W. & Co., Waterloo  
 Feick, John R., New Hamburg  
 Fell, W. T., Toronto  
 Fennell, John & Son, Berlin  
 Ferguson Bros., Teeswater  
 Fero, Thos., Tilsonburg  
 Field, J. & H., Teeswater  
 Fisher, R. J. W., Elmwood  
 Fitzgerald & Co., Colborne  
 Fletcher R., Toronto  
 Foisy, H., Ottawa  
 Foley, W. S., Woodville  
 Folsetter, John R., Aylmer  
 Foncar, L. P., Toronto Junction  
 Forbes, William, Grimsby  
 Foster & Hobbs, Tilsonburg  
 Foulter, John J., Baden  
 Found, G. A., Whitechurch  
 Franks, John W., Woodbridge  
 Fraser, David, Norwood  
 Frauce, John, Toronto  
 Fuller, John W., Tamworth  
 Galbraith, R. H., Hillsburg  
 Gale, G., Toronto  
 Gardiner, John, Dundalk  
 Gardiner & Co., Woodstock  
 Gardiner & Mulligan, Millbrook  
 Garner, R. & Son, Niagara Falls South  
 Gerry, N. & N., Brussels  
 Gibbons, Peter, Port Colborne  
 Gibson & Jones, Pembroke  
 Giles, Janet, Toronto  
 Gillespie, C. S., Campbellford  
 Gillrie, H. W., Arthur  
 Gilpin Bros., Orillia  
 Clendinning, T. H. & Co., Sunderland  
 Glover, John H., Aylmer  
 Godden, C. P., Toronto  
 Goodhue, W. H., Port Stanley  
 Gordon, Wilbur, Tweed  
 Gower, J. & Co., Newmarket  
 Graham, Thomas & Sons, Toronto  
 Graham W., Ottawa  
 Grant Bros., Ottawa  
 Grant, J. M., Ottawa  
 Graven, Edward, Barrie  
 Graves Bros., Ottawa  
 Gray & Co., Orangeville  
 Green, F. S., Waterford  
 Green, H. M., Ridgetown  
 Greenhill, J. S., Leamington  
 Grise, D., Midland  
 Groskurth Bros., Grand Valley  
 Hadden, R., Picton  
 Hambly, W. H., Kingston  
 Hambly & Hodgson, Thamesville  
 Hamilton Hardware Co. Ltd. (The), Hamilton  
 Haney, F. & Co., Tilsonburg  
 Hannah, G. R., Shelburne  
 Hanton, J. D. & Co., Ottawa  
 Harkness, A. S., Brigden

Harland & Bros., Clinton  
 Hartleib, Chas., Zurich  
 Haskett & Bro., Markdale  
 Hatch & Co., Toronto  
 Hatch & Bros., Whitby  
 Hay, N. & G., Ottawa  
 Hayden, John, Cobourg  
 Heard, Joseph, Fenelon Falls  
 Hearle, Wm., Beamsville  
 Helwig, George W., Hanover  
 Hemphill, Thomas, Wroxeter  
 Henderson, J., Collingwood  
 Henderson, Jonathan, Barrie  
 Henderson, Joseph T., Niagara Falls  
 Henry, O. B. & Co., Drayton  
 Herbert C., Caledon East  
 Hewitson, J., Toronto  
 Hickox, Robert, St. Catharines  
 Hillhouse, J. & Co., Clifford  
 Hinds, Oswald, Manitowaning  
 Hoar, T. E. & Co., Toronto Junction  
 Hobbs, A., Elora  
 Hobbs, Samuel, Toronto  
 Hobbs Hardware Co., London  
 Hodge, William & Co., Newmarket  
 Hohmeier & Leitch, Waterloo  
 Hollingsworth, W. S., Picton  
 Holmes, James, Woodstock  
 Hope, Adam & Co., Hamilton  
 Horsey, R. M. & Co., Kingston  
 Hose, Jacob, Rat Portage  
 Hoskins, G. B., Melbourne  
 House, I. M., Gravenhurst  
 Howard, George, Guelph

**H**OWLAND, H. S. SONS & CO., Toronto,  
 Wholesale Hardware Merchants.

Huffman, D. E., Jarvis  
 Hunt, L. I., Alvinston  
 Hunter, A., Brussels  
 Hunter, James, Plattsville

**H**UNTER, S. S. M., Pembroke,  
 Shelf and Heavy Hardware,  
 House Furnishings, &c.

Husband, D. A. & Co., Hagarville  
 Huson, Horace & Co., Paris  
 Hutchison, G., Peterborough  
 Hymmen & Russell, Berlin  
 Ibbotson, B., Toronto  
 Ironside, W. N., Thedford  
 James, Jacqueline J., Courtright  
 James & Reid, Perth  
 Jeffrey Bros., Stratford  
 Jeffrey, A. & Sons, Toronto  
 Jewell S., Mount Albert  
 Johns, Wm. H., Southampton  
 Johnson Bros., Seaforth  
 Johnston, Thos., Napanee  
 Johnston & Fair, Millbrook  
 Jones, Henry, Uxbridge  
 Jones, James, York  
 Jones, W. H., Ingersoll  
 Joss & Co., Toronto  
 Kasting & Bruce, Watford

## HARDWARE MERCHANTS.

### ONTARIO.—Continued.

Kastner & Mock, Stratford  
 Kauffam, W., Drumbo  
 Keast, C. E., Clarksburg  
 Kelly, B. G., Clarksburg  
 Kelley, John, Oakville  
 Kelly, P. D. & Son, Alliston  
 Kelly & Marshall, Orangeville  
 Kemp, C. B., Brighton  
 Kennedy, J. W. & Co., Georgetown  
 Kerr, Robert, Fergus  
 Keys, Henry, Weston  
 Kilmaster, E. A., Port Rowan  
 Kilmer, E., Durham  
 Kilmer & Co., Kincardine  
 King, John, Cookstown  
 King, Stephen, Ingersoll  
 Kingan & Allen, Peterborough  
 Kingsboro, John, Kinmount  
 Kitchen, G. & J., Schomberg  
 Knox, T. A., Coldwater  
 Krees, M., Durham  
 Kreig, Herman, Hespeler  
 Laing, Joseph, Ridgetown  
 Laing & Meharry, Port Perry  
 Lamont, Allan, Mount Forest  
 Lauchrin, J. L., Mattawa  
 Laverdure, E. G. & Co., Ottawa  
 Lawrie, A. & Co., Sarnia  
 Leacy, Patrick, Cardinal  
 Lee, J. D., Arnprior  
 Leisemere, C., Mildmay  
 Lendon & McDonald, Florence  
 Lepad, F. N., Owen Sound  
 Leslie, Peter, Alexandria  
 Lewis, J. H., Smith's Falls

#### **L**EWIS, JOHN & CO., Belleville,

Hardware Merchants,

##### Fine Cutlery and Silverware, Paints, Oils, and Glass.

Lewis, Rice & Son, Ltd., Toronto  
 Liebeta, Gustave, Baden  
 Lillie, Robt., Sturgeon Falls  
 Lothead, Wm., Forest  
 Loucks, E. B., Kingston  
 Lynch, William, Palmerston  
 McArthur, J., Hensall  
 McBridge, W. J., Toronto Junction  
 McCallum, J., Vankleek Hill  
 McCarthy, G. R. & Co., Smith's Falls  
 McCartney & Reid, Orangeville  
 McClanahan Bros., Belwood  
 McClellan, Henry, Alton  
 McClellan, Henry, Hillsburgh  
 McConnel, M., Cayuga  
 McCurdy, Angus, Fordwich  
 McDonald, John & Son, Paisley  
 McDonald, J. W., North Bay  
 McDonald, Thos., Mitchell  
 McDonald, W. A., Parkhill  
 McDougal & Cuzner, Ottawa  
 McEdward & Moore, St. Catharines  
 McFarland, W. C., Toronto  
 McGaw, J., Markham  
 McGill, William, Thorold  
 McGowan Bros., Uxbridge  
 McGuire, Chas. E., Westport  
 McHardy, Jno. H., Teeswater

McIntyre, D. C., Forest  
 McKay, A. & Co., Brussels  
 McKay, John, Hepworth  
 McKay, S. L., Kingsville  
 McKenzie, R. W., Goderich  
 McKinley & Northwood, Ottawa  
 McLaren, Geo. & Co., Port Elgin  
 McLean, Hugh, Belgrave  
 McLennan & Co., Kingston  
 McLeod, W. C., Woodstock  
 McMurray, P., Welland  
 McMurtry, W. J., Galt  
 McPherson, Wm., Cannington  
 McSween, Hugh, Leamington  
 McVean & McVean, Dresden  
 Maas, Albert, Toronto  
 Mackenzie, Milne & Co., Sarnia  
 Macnab Bros. & Co., Orillia  
 MacNaughton & Co., Cobourg  
 Madole, M. S., Napanee  
 Mainer, R., Orillia  
 Manning, W. H., Coldwater  
 Marshall, James, Oil Springs  
 Marshall & Mason, Strathroy  
 Martin, D., Stirling  
 Martin, Robert, Arthur  
 Martindale & Co., Alliston  
 Martini, John, Rodney  
 Mason, Chas., Richmond Hill  
 May, H. S., Huntsville  
 May, John H., Cannington  
 May, W. A., Creemore  
 Meiklejohn, A. & J., Harriston  
 Meiklejohn, L., Stirling  
 Mennie, John, Fergus  
 Meredith, Thos. & Co., Toronto  
 Merrill, H. S., Lansdowne  
 Metcalfe, J. J., Shelburne  
 Nicks & Cox, Peterborough  
 Mickus, W. F., Preston  
 Middlemiss, J. F., Mitchell  
 Miller, M., Orillia  
 Mills, Stanley & Co., Hamilton  
 Mitchell, Alexander, Cayuga  
 Mitchell, Wm., Kingston  
 Moir, G. A. & Co., Almonte  
 Moir, J. S., Arnprior  
 Moonan, J. P., Mount Forest  
 Moore, H. E., Oakville  
 Moore, J. R., Richard's Landing  
 Moore, John T., Milton  
 Moore, Nelson, Warton  
 Moore, Robert, Listowel  
 Morgan, E., Delhi  
 Morris, G. B., Guelph  
 Morris, J. H. & Son, Forest  
 Morrison, W. H., Shedden  
 Morton, E. T., Campbellford  
 Morton, J. Y., Brantford  
 Morton & Adam, Chatham  
 Morton & Christie, Walkerville  
 Morton & Christie, Windsor  
 Moser, J. G., Blyth  
 Moses, Joseph, Toronto  
 Mowat & Co., Trenton  
 Moyer, C. E., Berlin  
 Muirhead, William, Carleton Place  
 Mullholland, R. A., Port Hope  
 Mullett, Wm. T. & Co., Toronto

ONTARIO.—Continued.

Mullett & Jackson, Seaforth  
 Murray, W. L., Toronto  
 Nelson, A. E., East Toronto  
 Nelson, James & Bro., Windsor  
 Nesbitt, D. J., Brighton  
 Neveux, Clinton & Baxter, Windsor  
 Nichlin, J. W., Moorefield  
 Nichols, A. E. & Co., Fergus  
 Noble, A. B. & Co., Shelburne  
 Noble, Charles E. & Co., Dundalk  
 Nott & Turnbull, Brantford  
 Occomore, F. & Co., Collingwood  
 Oenstedd Bros., Blythe  
 Old, F. W., Caledonia  
 Oram, John W., Toronto  
 Otton, H. H. & Son, Barrie  
 Ough, Wm., Aurora  
 Paget & Hay, Unionville  
 Parent, Noah, Bell River  
 Parish, W. L., Port Perry  
 Patmore, E. R., Elora  
 Patton & Bro., Paris  
 Peaker & Sons, Brampton  
 Percy & Knox, Cobourg  
 Pearsall, George, Toronto  
 Pellow, James, Oshawa  
 Peterborough Hardware Co., Ltd., (The), Peterborough  
 Peters, A. E., Sundridge  
 Peters, C. M., Midland  
 Peters, R., Elmvale  
 Phillips Bros., Havelock

**PHILLIPS, T. & CO., Orillia,**

**Tinsmiths, Plumbers and Steamfitters,**

**Dealers in Stoves, Hot Air Furnaces, House Furnishings,  
 Paints, Oils, Hardware, &c.**

Philip T. H. & Co., Port Perry  
 Pickup, W. S., Millbrook  
 Pierce, Jas. H., Chippawa  
 Pike, Wm., Toronto  
 Pincombe, J. L., Toronto  
 Pitts, R. J., Cornwall  
 Playfair, James & Co., Collingwood  
 Plummer & Young, Sault Ste. Marie  
 Porter, R., Harrow  
 Puddecombe, J., jr., Bothwell  
 Purvis Bros., North Bay  
 Purvis Bros., Sudbury  
 Purvis Bros., Webbwood  
 Rae, John, Alvinston  
 Rae & Sutton, Milverton  
 Ralph, John, Goderich  
 Ramsden, George, Erin  
 Rat Portage Hardware Co., Rat Portage  
 Reazin, W. J., Pickering  
 Redfern, J. W., Owen Sound  
 Reid, C. A., Hagersville  
 Reid, Dugald, Georgetown  
 Reid, J. & Co., London  
 Reid & Wilson, Seaforth  
 Rettenmeir, Jos., Duart  
 Reynolds & Co., Toronto

**RICE LEWIS & SON, Ltd., Toronto,**

**Hardware Merchants.**

Richardson, Geo. A., Guelph  
 Richardson, W. H., Essex  
 Riddell, John E., Hamilton  
 Risdon & Livesey, St. Thomas  
 Ritter, John, Newton  
 Robertson, J. M., Tweed  
 Robertson, J. S., Toronto  
 Robertson & McKay, Ingersoll  
 Rogers, Elizabeth A., Richards Landing  
 Rolston, James, Dunnville  
 Ross, Bros. & Co., Iroquois  
 Ross, R. W. & Co., Prescott  
 Rosser, Frank, Ailsa Craig  
 Rusk, Irwin, Southampton  
 Russland, A. M., Little Britain  
 Ruth Bros., Ridgetown  
 Rutherford, John, jr., Embro  
 Rutherford & Douglas, Gorrie  
 Rutherford & Munro, Wroxeter  
 Ryan, John J., Toronto  
 Samson, Wm. T., Blenheim

**SAMUEL, M. & L. BENJAMIN & CO.,**

**TORONTO.**

**Hardware and Metal Merchants.**

**LONDON, Eng. : Samuel, Sons & Benjamin, 104 Fenchurd St.**

Saunders, Albert, Toronto  
 Saurivl, Adelard, Lancaster  
 Schneiker Rothermel, Milverton  
 Schwidt, E., Schringville  
 Scott, W. G. & Co., Mount Forest  
 Scott, Wm. & Son, Forest  
 Sriver, J. E., Tilbury Centre  
 Seamon, William, Holstein  
 Sears, G., Kingston  
 Sehl, Frederick, Baden  
 Shalloe, M., Park Hill  
 Shannon, Isaac, Tara  
 Shaw, David, Almonte  
 Shaw & Wooliver, Wallaceburg  
 Sheldrick, James, Hagersville  
 Shepherd, Arthur, Toronto  
 Sheridan, W. & J., Brockville  
 Shoemaker, O. & F., Chatham  
 Simpson, W. G., Moorefield  
 Singleton, W. R., Delta  
 Sinclair, A., Paisley  
 Skeith, Wm., Cornwall  
 Skinner & Ryan, Pembroke  
 Smart, R. H., Brockville  
 Smiley Bros. & Co., St. Thomas  
 Smith, C. F. & Co., Belleville  
 Smyth, C. H., Wyoming  
 Smith & Pethick, Wingham  
 Snyder, Frederick, Berlin  
 Spackman, E. H., Blenheim  
 Spackman, H., Exeter  
 Sparling & Co., Neustadt  
 Sparrow, W. H., Toronto  
 Stacey Hardware Co., St. Thomas  
 Stanley, & McLaggan, Chesley  
 Startup, David, Toronto  
 Steacy, B. D., Brockville  
 Steele, John, Dunnville  
 Stephens, Geo., Chatham  
 Stephen, G. & Son, Peterborough

## HARDWARE MERCHANTS.

### ONTARIO.—Continued.

Stevenson, Francis, Toronto  
Stevenson, Hugh, Toronto  
Stewart, D. A., Stayner  
Stewart, James, Pembroke  
Stewart, M., Tilbury Centre  
Stewart, P. S. & Co., Renfrew  
Stewart, R. J., Norwood  
Storey & Freeman, Milton  
Strachan, A., Kingston  
Strachan, William, Ottawa  
Stutt & Armstrong, Orono  
Summerfeldt, M. R., Mount Albert  
Sutton, F. G., Erin  
Tait, A. H., Pakenham  
Tait & Douglas, Campbellford  
Taplin, E. W., Novar  
Taylor, D. C., Lucknow  
Taylor, Thomas, Toronto  
Taylor, William, Carleton Place  
Taylor William, Chatsworth  
Taylor & Crow, Welland  
Thomson Bros, Port Elgin  
Thompson, J., & Co., Thorold  
Thompson, T. I., Owen Sound  
Thorburn, William, Gore Bay  
Tillson & Whitten, Bracebridge  
Traill Bros., Walkerton  
Trelford, John E., Markdale  
Trull, Thos. E., Stouffville  
Tucker, W. J., Manitowaning  
Turner, Nelson & Son, Cornwall  
Unitt, Frederick W., Toronto  
Van Camp, F., Lindsay  
Van Dusen & McDonald, Tara  
Van Tuyl & Fairbank, Petrolia  
Vanzant, G. R., Markham  
Vokes Hardware Co., Ltd, (The), Toronto  
Vickers, William, Maganetewan  
Macksmuth, Wm., Elmira  
Waites, John, Owen Sound  
Walker, H. J. & Son, Warkworth  
Walker, Jno. W., Belleville  
Walker, Robert E., Caledonia  
Wallace, George W., Toronto  
Wallace & Buchanan, Galt  
Warren, H. & J., Stirling  
Warren & McCarthy, Perth  
Watkins, Charles, Toronto  
Webster, W. G., Streetsville  
Weichel, M. & Son, Elmira  
Wells & Emmerson, Port Arthur  
Welsh, John G., Bervie  
Weltz & Co., Elmira  
Wescott, H. & Son, Beaverton  
West & Davis, Wallaceburg

Westman, A., London  
Westman Bros., Chatham  
Westman, Elijah, Toronto  
Weston, J. E., Tilsonburg  
Wheeler & Bain, Toronto  
White Bros., Huntsville  
White, Geo. A., Trenton  
White, G. H., Orillia  
White, Thos. R., Almonte  
Whitten, W. J., Toronto  
Whitworth, C. H., Westport  
Wieler, Oscar, Huntsville  
Wigle, E. R., Ruthven  
Wigle, D. D. & Bro., Alvinston  
Wigle, D. L. Son & Co., Windsor  
Willard, Nelson, Prescott  
Wilkins & Co., Toronto  
Williams, J. S., Picton  
Wilson, Alex., jr, Hastings  
Wilson, G. C. & Co., Dundas  
Wilson, H. J., Niagara  
Wilson, Jos., Bright  
Wilson, W. R., Waterdown  
Wilton & Turnbull, Brussels  
Wittmaack, A. H., Hespeler

### **WOOD, VALLANCE & CO., Hamilton,**

**Iron Merchants**

**Importers of British and Foreign Hardware.**

Woods, W. G., Lindsay  
Woodsworth, Joseph, Toronto  
Woodward Bros., Cannington

### **WORKMAN, A. & CO., Ottawa,**

**Shelf and Heavy Hardware,**

**Carriage Woodwork, &c.**

Workman, W. & F., Stratford  
Worth, Richard, Bowmanville  
Wright, G. H., Penetang  
Wright, James & Co., London  
Wright, James & Son, Strathroy  
Wright & Allen, Aylmer  
Yates, James, Goderich  
Young, Alex., Wingham  
Zilliax & Sarvis, Listowel  
Zinge, A. E., Morriston  
Zyrd & Co., Hespeler

## PRINCE EDWARD ISLAND.

Crabber, S. W., Charlottetown  
Dawson, Wm. E., Chalottetown  
Dodd & Rogers, Charlottetown  
Fennell & Chandler, Charlottetown

McKay & Bruce, Summerside  
Norton, R. B. & Co., Charlottetown  
Richards, D. M. & Co., Charlottetown



## QUEBEC.

Amiot, Lecours & Lariviere, Montreal  
 Archambault, Ernest, Montreal  
 Barriere, Charles M., Montreal  
 Beaudry & Jourdain, Three Rivers  
 Beaudoin, J. O., Cookshire  
 Beland, Charles J., Montreal  
 Belanger, Elzear, Montreal  
 Belgian Syndicate, Comptoir Belgo-Canadien, Montreal  
 Bigaouette, J. E., Quebec  
 Boucher, A., Sherbrooke  
 Boulet, E. O., Quebec  
 Bourgeois, S. & Co., St. Hyacinthe  
 Brien, Ovide, Laurentide  
 Brissette, A., St. Felix de Valois  
 Brousseau, G., Quebec  
 Brunette, J. C., Montreal  
 Buzzell Nelson & Co., Cowansville  
 Cantin, A. A., Quebec  
 Cauchon, Oliver, Montreal  
 Cavanagh, Edward, Montreal  
 Caverhill, Learmont & Co., Montreal  
 Champagne, Onesime, Montreal

**CHINIC HARDWARE CO. (The), Quebec,**  
**Wholesale and Retail Hardware Merchants,**  
**Manufacturers of Cut Nails and Mill Stones.**

Chouinard, Calixte, Montreal  
 Chovinard, Wilfred, St. Louis de Mile End  
 Codere, Sons & Co., Sherbrooke  
 Coghlin, Bernard J., Montreal  
 Colletet, E. D., Montreal  
 Corbeille, O., Montreal  
 Cote & Frere, St. Johns  
 Couillard, Auguste, Montreal  
 Couillard, Louis, Montreal  
 Couillard, Louis, St. Cunegonde  
 Cowan, J. S. & Co., Montreal  
 Crathern & Caverhill, Montreal  
 Demers, Pierre, Montreal  
 Denis, J. A., Montreal  
 Denis, Louis N., Montreal  
 Depocas, Henri A., Montreal  
 Depocas, H. A., St. Henry  
 Desaulniers & Cie, St. Anne de la Parade  
 Deschamps, Alfred, Montreal  
 Desforges & Geoffrion, Montreal  
 Desilets, Joseph, Louiseville  
 Desjardins, Napoleon, Montreal  
 Dion, Joseph, Quebec  
 DomBrowski, A. L., Quebec  
 Dore, Alde, Buckingham  
 Dorken Bros., Montreal  
 Doyle, Wm., Quebec  
 Drysdale, David, Montreal  
 Ducondu, L. N., Joliette  
 Dumas, Mrs. F., Quebec  
 Emery, A. J., Barnston  
 Evans, J. A., Sawyerville  
 Faucher & Fils, Montreal  
 Fauteux Hercule, Montreal  
 Fatteaux, Hercule, St. Cunegonde  
 Feun, W. H., Montreal

**FOSS, A. H., Sherbrooke,**  
**Hardware, Sporting Goods, Plated Ware,**  
**Paints, Oils and Varnishes.**

Filion, Joseph, St. Therese  
 Fortier, Charles, Montreal  
 Fortier, Chas., St. Henri  
 Francis, W. & V., Montreal  
 Frothingham & Workman, Montreal  
 Garneau, J. Israel, Levis  
 Gates, E. & P., Waterloo  
 Gaucher, R. G., Montreal  
 Gaudet, Alf., Nicolet  
 Gauvin, E. E. & Co., Magog  
 Giguere, L. C., Quebec  
 Godin, Jos. & Fils, Three Rivers  
 Gosselin, J. A., Drummondville  
 Gougeon, F. X., Montreal  
 Gougeon, F. X., St. Henri  
 Gouin, P. A. & Cie, Three Rivers  
 Granger, Napoleon, Montreal  
 Granger, S. Jules, Montreal  
 Granger, Ulric, Montreal  
 Gravel, & Boulard, Montreal  
 Grenier, Hector, Quebec  
 Grenier, J. A., St. Thecle  
 Grose, Walter, Montreal  
 Hebert, L. H., Montreal  
 Holler & Hecker, Montreal  
 Howden, Starke & Co., Montreal  
 Huet & Cie., Montreal  
 Johnson, Copping & Co., Montreal  
 Jones, Harry, Westmount  
 Kane, J. R., Quebec  
 Kerouack, J. L., St. Ephrem d'Upton

**KERR, JAS. F., Sherbrooke,**  
**Dealer in General Shelf Hardware.**

**Paints, Oils, Varnishes, Bicycles, Stoves, Tinware.**

Kerr, R. & W., Montreal  
 Laberge, Alphonse, Montmagny  
 Lafleur, I. L., Montreal  
 Lallemand, Amable, Montreal  
 Lalonde, Jos. H., Coteau Landing  
 Lamarce, Henri, Montreal  
 Lambert, J. H., Montreal  
 Langlois, P. N., Quebec  
 Lapointe & Lapointe, Quebec  
 Laporte, Napoleon & Son, Montreal  
 Laurendeau, P., Magog  
 Laveau, Chas., Quebec  
 Laviolette, S. G., St. Jerome  
 Leblanc, Armand, Montreal  
 Leblanc, Chas., Joliette  
 Lemieux, N. & Fils, Quebec  
 Lemoine, P. C., Sorel  
 Leprohon, M. H. & Cie., Joliette  
 Leroux, A., sr., Montreal  
 Leroux, Alphonse, Montreal  
 Letang, Letang & Co., Montreal  
 Letourneau & Auger, Victoriaville  
 Le Tourneux Bros. & Co., Montreal

**LEWIS BROS. & CO., Montreal,**  
**Hardware Merchants.**

Loiselle, H., Valleyfield  
 Lortie, Cyrille, Montreal  
 Lucke & Mitchell, Sherbrooke

## HARDWARE MERCHANTS.

### QUEBEC.—Continued.

McGillis, N., Lachute  
 Macpherson, Alex. & Son, Montreal  
 Madore, David, Montreal  
 Marceau & Letourneaux, Montreal  
 Marceau & Letourneaux, St. Henri  
 Marston, G. J., Hull  
 Martineau, J. E., Quebec  
 Martinette, Alf., St. George East  
 Massicotte, J. N. & Cie., Montreal  
 Mason & Co., Montreal  
 Mathieu, Napoleon, Montreal  
 Millen, John & Son, Montreal  
 Millot, Philip, Montreal

**MITCHELL, J. S. & CO., Sherbrooke,**  
 Successors to Luke & Mitchell,  
**Iron and Hardware Merchants,**

Importers of Anthracite and Bituminous Coal.  
 Carriagemakers' and Blacksmiths' Stock, Paints, Oils, Varnishes,  
 Mining and Mill Supplies, Gunpowder and Dynamite.

Mohr, Geo. T., Guyon  
 Morin, J. H., St. Hyacinthe  
 Naireux, L. N. & J. E., Montreal  
 Nobert, L. A., Louiseville  
 Noel & Cie, Quebec  
 Noel & Dagneau, Quebec  
 Norman, August, Montmagny  
 Page, Remi, Les Ecoreuils  
 Pallascio, Alphonse, Montreal  
 Panneton & Blouin, Three Rivers  
 Papillon, Eugene, Les Ecoreuils  
 Papineau, Joseph B., St. Cunegonde  
 Paquette, Jean, Montreal  
 Parent, Chas. A., Quebec  
 Patry, J. H., Quebec  
 Pauze & Lamouche, Montreal  
 Perrin, E. & Co., Montreal  
 Philbin, Michael, Montreal  
 Picard, Henri, Montreal  
 Ponton, Louis, Montreal  
 Provost & Fleury, Montreal  
 Prowse, G. R., Montreal  
 Prud'homme, A. & Frere, Montreal

Prud'homme, Gedeon, Montreal  
 Quipp, J. W., Montreal  
 Raitt, Jno., Lachute  
 Rastoul, F. X., Montreal  
 Reaume, P. F., Quebec  
 Renaud, Adolph, Montreal  
 Renaud, J. H., Joliette  
 Robb, Geo., Knowlton  
 Robert & Chouinard, St. Henri  
 Robertson, Thomas & Co., Montreal  
 Robitaille & Picher, Quebec  
 Rock Island Hardware Co., Rock Island  
 Rollin, Pariseau & Cie., Montreal  
 Rousseau, E., Nicolet  
 Roussin, Calixte, Montreal  
 Roy Freres, Montreal  
 Royer & Rougier Freres, Montreal  
 Samson & Filion, Quebec  
 Samuel, M. & L. Benjamin & Co., Montreal  
 Saucier & Co., Louiseville  
 Sayer, Thos. D., Aylmer  
 Scott, H. S. & Co., Quebec  
 Seybold, Son & Co., Montreal  
 Sharpe, C. A., Montreal  
 Shaw, S. J. & Co., Quebec  
 Sigouin & Watts, Montreal  
 St. Amour, Napoleon C., Montreal  
 St. Jean Freres, Montreal  
 Surveyer, L. J. A., Montreal  
 Sylvester, H. & Son, Laprairie  
 Thompson, B. & S. H., Montreal  
 Tobin, Edward, Montreal  
 Tremblay, P. O., Montreal  
 Valiquette, H. R., Montreal  
 Vanvliet, Geo. M., Lacolle  
 Walker, James & Co., Montreal  
 Wallace, J. I. & Son, Waterloo  
 Webster, W. C. & Son, Coaticook  
 Wilson Bros., Danville  
 Wilson, J. H., Montreal  
 Wilson, William & Co., Montreal  
 Woodburn, Ed. J., Richmond  
 Wright, C. P., Aylmer  
 Young, H. & J., Quebec

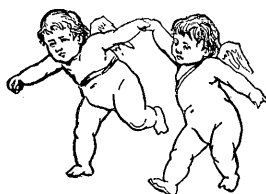

**3847—FLOUR & FEED MERCHANTS — In  
Province of Quebec, New Brunswick,  
Nova Scotia & Prince Edward Island.**

Allan, Robert & Co., Montreal, Que.  
Asselin, E., Joliette, Que.  
Austin, M. D., St. John, N. B.  
Bachand, Stanislas, Coaticooke, Que.  
Baldwin, Bruce, R., Dixville, Que.  
Baldwin, P. T. & Son, Coaticooke, Que.  
Barbour, Geo. L., St. John, N. B.  
Bayley, C. F., Beebe Plains, Que.  
Bell, A. C., New Glasgow, N.S.  
Benoit, F. X., Montreal, Que.  
Bent, G. & Sons, St. John, N. B.  
Bernier & Cie., St. Hyacinthe, Que.  
Bertrand, Nazaire, St. Liboire, Que.  
Bishop, J. H., Wolfville, N.S.  
Black & Co., Truro, N.S.  
Boisvert Frères, Montreal, Que.  
Bourbeau, D. O., Victoriaville, Que.  
Bourbeau, J. O., Victoriaville, Que.

**B**OURGEOIS, L. N. & CO., Danville, Que.

**General Merchants in Groceries, Dry Goods,  
Flour, Grain, Feed, Seeds, &c.  
Boots & Shoes.**

Bournival, Thos. & Cie., Trois-Rivières, Que.  
Bousquet, M., St. Hyacinthe, Que.  
Bowman, I. C., St. John, N. B.  
Brodeur, Joseph, St. Hyacinthe, Que.  
Brodeur, Wilfrid, Montreal, Que.  
Brodie, W. & R., Quebec, Que.  
Brodie & Harvey, Montreal, Que.  
Brouillard, O., Carmel, Que.  
Bruneau, Currie & Co., Montreal, Que.  
Brunelle, L. & Frère, Trois-Rivières, Que.  
Burrill, W. & Co., Yarmouth, N.S.

**B**USSIERES, P. G. & CO., Quebec, Que.

**Flour, Grain, Fish & Provisions. Seed Grain of  
all kinds. Correspondence Solicited.**

Cameron, A. D., Buckingham, Que.  
Cameron, A. E., Brockville, Ont.  
Carignan, O. & Fils, Three Rivers, Que.  
Carrier, William, Quebec, Que.

**C**ARRIER, A. & FILS, Levis, Que.

**General Wholesale Merchants & Importers.  
Groceries, Wines & Spirits, Heavy  
Hardware, Flour & Produce.**

Carvell, Bros., Charlottetown, P. E. I.  
Chanell, H. A., Stansted, Que.

**C**HASSE, T. N., Quebec, Que.

**Broker in Flour, Grain & Provisions.  
Correspondence Solicited.**

Chipman, J. A. & Co., Halifax, N.S.,  
Clough, C. R. & Co., Lennoxville, Que.  
Cotnoir, L. N., St. Germain de Grantham, Que.  
Cowan, Joshua E., St. John, N. B.  
Cox, J. P., Halifax, N.S.  
Coyette, B., Magog, Que.

Craig, E. F., Montreal, Que.  
Craig, R. T. & Co., Truro, N.S.

**C**REAM, ROBERT F. & CO., Quebec, Que.

**Dealers in Flour, Grain & Mill Feed.**

Creswell, R., Lachute, Que.  
Crosby, A. R., Yarmouth, N.S.  
Crosby, L. G., Yarmouth, N.S.  
Cunningham & Curren, Halifax, N.S.  
Daigle, J. & P., Montreal, Que.  
Daignault, P., Montreal, Que.  
David, W., Montreal, Que.  
De Forest, Geo. S. & Sons, St. John, N. B.  
DeWolf, J. E. & Co., Kentville, N.S.  
Douglas & Co., Amherst, N.S.  
Drolet, D. E., Quebec, Que.

**D**ROUIN, BROS. & CO., Quebec, Que.

**Manufacturers of Spices.  
Sole Manufacturers of the Celebrated  
Baking Powder "Cook's Delight".**

Drummond Lumber Co. (The), Forestdale, Que.  
Dufresne, Napoleon, Three-Rivers, Que.  
Dunlap, Bros. & Co., Amherst, N.S.  
Dunlap & Co., Moncton, N. B.  
Dupuis, O., St. Eugene de Grantham, Que.  
Durocher, E. & Co., Montreal, Que.  
Eisenhauer, James & Co., Lunenburg, N.S.

**E**PHRAIM ERB & CO., Halifax, N.S.

(Ephraim Erb.,—W. B. Rankin.)

**Brokers, Millers' and Manufacturers' Agents.**

Farquharson, J. A. & Co., Charlottetown, P. E. I.  
Finley, Joseph, St. John, N. B.  
Fitzgibbons, Michael, St. Ephrem d'Upton, Que.  
Fraser, A. E., Springhill, N.S.  
Gendreau, G., Arthabaskaville, Que.  
Gendron, Denault & Co., Sherbrooke, Que.

**G**ENEST, C. O. & FILS, Sherbrooke, Que.

**Dealers in Pork, Flour, Grain, Provisions,  
Kerosene, Coal Oil, Machine Oil, &c.**

Gibson Bros., Danville, Que.  
Girard & Co., St. Liboire, Que.  
Gorman, Thomas, St. John, N. B.  
Griffith & Thompson, Montreal, Que.  
Gunn, A. & Co., Halifax, N.S.  
Hall & Fairweather, St. John, N. B.  
Harrison, Jeremiah & Co., St. John, N. B.  
Harrison, W. F. & Co., St. John, N. B.  
Harris, T. R., Wolfville, N.S.  
Harris, J. H. & Co., Moncton, N. B.

**H**ARTY, JOHN B., Yarmouth, N.S.

**General Commission Merchant,  
Ship Broker and Shipping Agent,  
Groceries, Provisions,  
Flour, Feeds, Hay, &c., &c.**

Hatheway, W. F., St. John, N. B.  
Hay & Bros., Lachute, Que.  
Hill, C. D. & Co., St. Stephen, N. B.  
Hurtubise, A. L. & Co., Montreal, Que.  
Ingraham, J. W., North Sydney, C. B.

Jardine & Co., St. John, N.B.  
Jourdain, N., Three-Rivers, Que.  
Judge, Edgar, Montreal, Que.  
Kathan, C. H., Rock Island, Que.

## **KIROUAC, F. & FILS, Quebec, Que.**

**Dealers in Flour & Wholesale Grocers.**

**Bakers' Strong Flour a Specialty,**

**Large Stock of Grain & Provisions.**

Lafontaine, E., Drummondville, Que.  
Lamy, J. & J. R., Amherst, N.S.  
Laforest, S., St. Cyrille, Que.  
Lafortune, R., Acton, Que.  
Laganière, T. H., St. Anne de la Pérade, Que.  
Lake of the Woods Milling Co., Montreal, Que.  
Lamothe, J., Three-Rivers, Que.  
Laroche, A., Quebec, Que.  
Levec & Cola, South Durham, Que.  
Leonard, M., Wickham West, Que.  
L'Hereux, E., St. Liboire, Que.  
Lovitt & Lovitt, Yarmouth, N.S.  
McAfee & Loomer, St. John, N.B.  
McAllister Bros., St. Stephen, N.B.  
McCallum & Lahaie, Buckingham, Que.  
McGregor, R. & Sons, New Glasgow, N.S.  
McKee & Armstrong, Richmond Station, Que.  
McLaughlin, J. F., Quebec, Que.  
McManus, J. B., Memramcook, N.B.  
McNicol, John, Sherbrooke, Que.  
Mackenzie, A., Richmond, Que.  
MacLeay & Riddle Bros., Danville, Que.  
MacMichael, C. & E., St. John, N.B.  
Mahew, T., Arthabaskaville, Que.  
Malcolm, Andrew, St. John, N.B.  
Manson & Boright, Magog, Que.  
Marcil, J. E., Acton, Que.  
Martin, W. G., Dixville, Que.  
Martin & Violette, St. Leonard, N.B.  
Martin & Warnock, Hull, Que.  
Merrill, J. H., Smith's Mills, Que.

## **MICHAUD BROS. & Co., Montreal, Que.**

**Receivers and Shippers of**

**Hay, Grain & Feed.**

Migué, Ed., Joliette, Que.  
Mills, H. C., Summerside, P.E.I.  
Milot, Chas., St. Monique, Que.  
Moore, A. H. & Co., Magog, Que.  
Morse, Jas. S., Wolfville, N.S.  
Muir, Wm. & Son., Halifax, N.S.  
Nase, P. & Son, St. John, N.B.  
Northrup & Co., St. John, N.B.  
Pape, C. E., Kingsey Station, Que.  
Parker, Eakins & Co., Yarmouth, N.S.  
Payzant & King, Halifax, N.S.  
Pepin, Honoré, Warwick, Que.  
Pepin, L. O., Arthabaskaville, Que.  
Peters, Chas. H., St. John, N.B.  
Piche, E. A., Drummondville, Que.

## **PLAMONDON, J. A., Quebec, Que.**

**Flour, Grain & Provisions, Wholesale.**

Plamondon, L. S., Acton, Que.  
Planche, H. A. & Co., Cookshire, Que.

## **POITRAS, OCT. T. & Co., Quebec, Que.**

**Wholesale, Flour, Crain Seeds,**

**Produce and Provision.**

Prefontaine, J. B. I., South Durham, Que.  
Provancher, H., St. Monique, Que.  
Ralston, B. W., Amherst, N.S.  
Randolph, A. F. & Sons, Fredericton, N.B.  
Rattenbury, N., Charlottetown, P. E. I.  
Reid, F. P. & Co., Moncton, N.B.

## **RENAUD, J. B. & Co., Quebec, Que.**

**Wholesale, Flour, Grain, Provision,**

**Fish & Fish Oil, Salt, Pressed Hay**

**& Maple Sugar.**

Rider, T. B., Fitch Bay, Que.  
Rivest, Frs., Joliette, Que.  
Robertson, Geo. & Co., St. John, N.B.

## **ROUSSEAU, J. A., Ste Anne de la Perade, Que.**

**Manufacturer of Furniture, Lumber,**

**Matches, Nail Keg Staves.**

**Shingles, Mouldings,**

**Flour Mill & General Merchant.**

Rousseau, T., Nicolet, Que.  
St. Jacques, Fremont, St. Hyacinthe, Que.  
Sayers, R. H., Aylmer, Que.  
Schwartz, W. O., Moncton, N.B.  
Scott, James & Co., Montreal, Que.  
Shand Bros., Windsor, N.S.  
Sinclair & Stewart, Summerside, P.E.I.  
Slipp & Harding, St. John, N.B.

## **SMITH, B. J., Coaticook, Que.**

**Dealer in Flour, Grain, Feed, Produce,**

**Hardware, Seeds, Wholesale & Retail.**

Steel, M. & Co., Melbourne, Que.  
Stoneman, A. F. & Co., Yarmouth, N.S.

## **SWENERTON, B., Halifax, N. S.**

**Millers and Manufacturers Agents,**

**Flour, Oatmeal, Peas, Barley, Split Peas,**

**Round Peas, Beans, Oats & Feed,**

**Bought & Sold in Car Lots.**

**Also Dealers in Cured and Fresh Meats.**

## **TANGUAY, ALF. T., Quebec, Que.**

**Wholesale, Flour, Grain & Feed, Provisions.**

## **TANGUAY, GEO., Quebec, Que.**

**Dealer in Flour, Grain, Pork, Fish, Oil, &c.**

Taylor, C. H., Stanstead, Que.  
Taylor, James E., Georgeville, Que.  
Thompson, Joshua, Levis, Que.  
Thompson, J. D., Buckingham, Que.  
Thompson, O. A., Magog, Que.  
Thompson, W., Yarmouth, N.S.  
Tourigny, P., Victoriaville, Que.

Tufts, F. & Co., St. John, N.B.  
 Turnbull & Co., St. John, N.B.  
 Turner, R. J., Truro, N.S.  
 Wallace, J. M. & Co., Moncton, N.B.  
 Watters, H. G. & Co., St. John, N.B.  
 Williams, H. E., Knowlton, Que.  
 Wilson, F. J., Buckingham, Que.  
 Winfield, J., Quebec, Que.

**3848—EGGS—Preserved.**

Auld Bros., Charlottetown, P. E. I.  
 Brown, F. A., Simcoe, Ont.  
 Doering & Co., Waterloo, Ont.  
 Dunseith, W., St. Mary's, Ont.  
 Hamilton, J., Baie Verte, N.B.  
 Hennigan, D., Vankleek Hill, Ont.  
 Hogg Bros., Oakwood, Ont.  
 Lloyd & Scully, Owen Sound, Ont.  
 Meldrum, Wm. & Co., Montreal, Que.  
 Moore, J. D., St. Mary's, Ont.  
 Nash & Lightizer, Charlottetown, P. E. I.  
 Scott & Hogg, Galt, Ont.  
 Sparling, George, Meaford, Ont.  
 Sparling, R. C., Wingham, Ont.  
 Spratt & Killen, Lindsay, Ont.  
 Swan, H. S. & Co., St. Hyacinthe, Que.  
 Waterloo Produce Co., Waterloo, Ont.  
 Zinkann, J. N., Wellesley, Ont.

**3849—EGGS—Fresh.**

Alexander, J. Montreal, Que.  
 Auld Bros., Charlottetown, P. E. I.  
 Ballantyne, Mrs & Son, Brussels, Ont.  
 Benson, Richard, Picton, Ont.  
 Booth & Co., Trenton, Ont.  
 Brankin, P., Ottawa, Ont.  
 Briggs, C. H., Hamilton, Ont.  
 Clark, J. W., Wellington, Ont.  
 Carr & Powers, Picton, Ont.  
 Carpenter, R., Ottawa, Ont.  
 Cowards, S. M., Mitchell, Ont.  
 Denne, Charles, Newmarket, Ont.  
 Dennis, G. H., Hamilton, Ont.

Duckett, H., Montreal, Que.  
 Fish, R. Y., Waterloo, Ont.  
 Gillanders, D., Wellington, Ont.  
 Gould Bros., Uxbridge, Ont.  
 Graham, R. J., Belleville, Ont.  
 Grant, A. W., Montreal, Que.  
 Hawley, John, Toronto, Ont.  
 Hislop & Hunter, Montreal, Que.  
 Hogg Bros., Oakwood, Ont.  
 King, A. J., Toronto, Ont.  
 Kirkpatrick & Cooksen, Montreal, Que.  
 Laraque, C., Glen Robertson, Ont.  
 Low, J. W., Alexandria, Ont.  
 McIntosh, George, Kirkhill, Ont.  
 McLennan, John, Dalkeith, Ont.  
 McPherson, D. A. & Co., Montreal, Que.  
 Meldrum, Wm. & Co., Montreal, Que.  
 Paxton, A. & Co., Toronto, Ont.  
 Young, J. F., Toronto, Ont.  
 Wait, Geo. & Co., Montreal, Que.  
 Ware, Wm. & Sons, Montreal, Que.

**NASH & LIGHTIZER, Charlottetown, P.E.I.**

**Eggs and Produce.**

Park, Blackwell & Co. Ltd., Toronto, Ont.  
 Paterson, Geo., Almonte, Ont.  
 Robertson, James, Almonte, Ont.  
 Scott, Gillies & Co., Strathroy, Ont.  
 Schummer, Peter F., St. Clements, Ont.  
 Smith, J. A., Brodie, Ont.  
 Sparling, R. C., Wingham, Ont.  
 Spratt & Killen, Lindsay, Ont.  
 Stewart Bros., Renfrew, Ont.  
 Stewart, J. H., Antigonish, N. S.  
 Swan, H. S. & Co., St. Hyacinthe, Que.  
 Waterloo Produce Co., Waterloo, Ont.  
 Wenger, Isaac, Ayton, Ont.  
 Whyte, John & Son, Mitchell, Ont.  
 Wilson, D. D., Seaforth, Ont.  
 Wright, A. A. & Co., Renfrew, Ont.

NOTE.—THE BUYERS' AND SELLERS' GUIDE OF CANADA, 1895-6 will be revised again in 1899. Canada's Merchants and Manufactures, by a little effort, can make this work the most useful medium, between Buyer and Seller, ever published for Canada ; it has come to stay and we expect you to help us.

**THE MANUFACTURES' LIST CO.,**

**MONTREAL, Que.**

**3850. MERCHANTS—Barley, Oats and Wheat.**

Ainsley, J. H., Port Dover, Ont  
Allison, H. H., Adolphustown, Ont  
Anderson & Coghill, Wyoming, Ont  
Andrews, T. & J. N., Thornbury, Ont  
Annett, James, Watford, Ont  
Argue, T. E., Carp, Ont  
Apps, Wm., Brantford, Ont  
Ball, O., Bath, Ont  
Beattie, James, Seaforth, Ont  
Bishop, A., Exeter, Ont  
Bogart, N. J., Chatham Ont  
Bothwell, J. M., Barrie, Ont  
Bramm, Bros., Berlin, Ont  
Brill, S. R., Teeswater Ont  
Brink, L. A., Teeswater Ont  
Brown & Co., Barrie, Ont  
Browne, W. B. & Co., Simcoe, Ont  
Bruce, G. F., Beaverton, Ont  
Buckles, James, Osgoode Station, Ont  
Campbell, A. J., Arnprior, Ont  
Campbell, & Rutherford, Blenheim, Ont  
Carruthers, Jas. & Co., Toronto, Ont  
Carter, G. Son & Co., St. Marys, Ont  
Carter, William, Guelph, Ont  
Chapman, R. G., Teeswater, Ont  
Chase, G. A., Orillia, Ont  
Chase & Frawley, Orillia, Ont  
Chisholm, H., Meaford, Ont  
Chisholm, Kenneth, Brampton, Ont  
Clegg, Wm., Wingham, Ont  
Coffee, L. & Co., Toronto, Ont  
Colby, Geo. E., Chatham, Ont  
Colliston, Preston & Prain, Harriston, Ont

**COLE, F. F., Toronto, Ont.,  
Grain, Commission, &c.,**

**Grain Store Houses in Ontario—Trenton,  
Brighton, Belleville, Kingston.  
In Manitoba—Boissevain, Whitewater, Kil-  
larney, Holmfield.  
37 Yonge Street.**

Cook, William, Meaford, Ont  
Cornell & Mitchell, Strathroy, Ont  
Cowdry, N. H., Lindsay, Ont  
Crane & Baird, Toronto, Ont.  
Crowe, H. & Co., Winnipeg, Man  
Dauncey & Brown, Exeter, Ont

**DAVIDSON & STEWART,  
Wallaceburg, Ont.,  
Wholesale and Retail dealers in  
Grain, Flour, Seeds, Pork and  
Produce,**

Dean, N., Renfrew, Gnt  
Delahey Bros., Cobden, Ont

**DE LAPORTE, A. V. & CO.,  
Toronto, Ont.,  
Commission Merchants,  
Grain, Flour, Oatmeal, Hay and Straw,  
Dried Apples, Butter, Eggs, and all kinds  
of Farm Produce.  
Advances made on Grain, Flour, etc.  
82 Front Street.**

**3850. Barley, Oats and Wheat—Continued.**

Denne, Charles, Newmarket, Ont  
Duñcombe & Shannon, Waterford, Ont  
Dunlop, James, Hamilton, Ont  
Dunnett, B. W., Kinburn, Ont.  
Excelsior Roller Mills (The), Hagersville, Ont  
Finkle, R. R., Bath, Ont  
Fowlds & Son, Hastings, Ont  
Gibson, Yeoman, Whitby, Ont  
Glenn, Samuel & Son, Chatham, Ont  
Goodall, James, Toronto, Ont  
Gordon, John D., Brampton, Ont

**GOULD BROS., Uxbridge, Ont.,  
Star Roller Mills,  
Manufacturers of Finest Grades of Roller  
Flour Dealers in Potatoes, Dressed  
Hogs, etc.**

Graham Bros., Aurora, Ont  
Graham, Geo., Clinton, Ont  
Graham Thos., Smiths Falls, Ont  
Graves, Campbell & Co., Crystal City, Man  
Gregory, Thos., Wingham, Ont  
Guy & Co., Oshawa and Brooklin, Ont  
Hall Bros., L'Orignal, Ont  
Hargraft & Co., Cobourg, Ont  
Harold, S., Brantford, Ont  
Hayne, Thos., Brigden, Ont  
Hay Bros., Listowel, Ont  
Hay, Robert, Toronto, Ont  
Heimbecker, —, Hanover, Ont  
Hemphill, Thos., Wroxeter, Ont  
Hewer, James, Guelph, Ont  
Hill, W. H., Sarnia, Ont  
Hinde, Wm., Harriston, Ont  
Horne, A. & Co., Charlottetown, P.E.I.  
Howney & Vanluven, Napanec, Ont

**HUME, JOHN, Port Hope, Ont.  
Seeds and Grains,  
Grain Buyer, Seed Grower, (Ex-  
ports) Wool.**

Hunter, A. S., Durham, Ont  
Irwin, Richard, Clinton, Ont  
Kemp, T. O., Seaforth, Ont  
Laing, Alex., Wyoming, Ont  
Lake of the Woods Milling Co., Keewatin, Ont  
Lake of the Woods Milling Co., Montreal, Que  
Lake of the Woods Milling Co., Portage La  
Prairie, Man  
Lake of the Woods Milling Co., Winnipeg, Man  
Lamont, James, Chatham, Ont  
Laurie, James, Seaforth, Ont  
Lazier, S. A. & Sons, Belleville, Ont  
Leitch Bros., Oak Lake, Man  
Legett, W., Exeter, Ont

**LEONARD, M.,  
West Wickham,  
General Merchant,  
Dealer in Railway Ties, Lumber, Timber,  
Telegraph Poles, Cord Wood, Flour,  
Feed, Grain, etc.**

**3850. Barley, Oats and Wheat—Continued.**

Lindsay, J., Orangeville, Ont  
Lockhart Bros., Bowmanville, Ont  
Long, J. H., Whitby, Ont  
Long, T. & Bro., Collingwood, Ont  
Lukes, Samuel, Bradford, Ont  
Lund, R. J., Woodstock, Ont  
Lundy, Chs., Newmarket, Ont  
Lyle, John, Bowmanville, Ont  
Matthews, W. D. & Co., Toronto, Ont  
Martin Bros., Mount Forest, Ont  
Maybee, R. Y., Vittoria, Ont

**McBAIN, JOHN J.,**  
Peterborough, Ont.

Grain and Produce Merchant,  
Office and Elevator, Charlotte Street.

**McBEAN, ARCH. & SON,**  
Toronto and Winnipeg,  
Grain Exporters.

Toronto Office, Board of Trade Bldg.

McCall, Alex., Simcoe, Ont  
McClellan & Co., Bowmanville, Ont  
McCuaig, Cheney & Co., Vankleek Hill, Ont  
McDougald, S., Renfrew, Ont  
McElroy, H. & Son, Carp, Ont  
McGinnis, W. G., Emerald, Ont  
McGregor, J. F., Alexandria, Ont  
McIntosh, P. & Son, Toronto, Ont  
McKay, E. P. & Co., Toronto, Ont  
McLaren, G. & Co., Port Elgin, Ont  
McLaughlin, J. F., Toronto, Ont  
McLean, W. A. & Co., Owen Sound, Ont  
McMurtrye & Co., Bowmanville, Ont  
McRae, Peter & Co., Ottawa, Ont

**MERRICK, S. S.,**  
Carleton Place, Ont.,

Dealer in all kinds of Grain, Pressed Hay and Farmers' Produce.  
Telegraph and Hop Poles, Pulp Wood, etc.  
Stove Coal.

Merilees & Co., Almonte, Ont  
Mitchell, T. G., Watfod, Ont  
Moore, J. D., St. Marys, Ont  
Morgan Bros., Hamilton, Ont  
Moyer, A. & Co., Listowel, Ont  
Murphy, E., Mount Forest, Ont

**NAIRN, STEPHEN,**  
Winnipeg, Man.,

Oatmeal Mills, Mfr. of Rolled Oats,  
Granulated and Standard Oatmeal, Pot  
and Pearl Barley, and other Breakfast  
Cereals.

Nelson & Co., Sandhurst, Ont  
Parrish & Lindsay, Brandon, Man

**PEER & CO., Toronto, Ont.,**  
Flour and Grain Merchants.

**3850. Barley, Oats and Wheat—Continued.**

Pembroke Milling Co. (The), Pembroke, Ont  
Perkins, James, Gorrie, Ont  
Perrin, W., Clinton, Ont  
Poehlman & Co., Hanover, Ont  
Powell, Geo., Blythe, Ont  
Pye, Charles, Clarksburg, Ont

**RICHARDSON, JAS. & SONS,**  
Kingston, Ont.,

Grain Merchants,  
Barley and Manitoba Wheat a Specialty.  
Richardson, W. B., Aurora, Ont

**ROBERTSON, JAMES,**  
Almonte, Ont.,

Wholesale dealer in Grain, Butter, Eggs  
and Poultry.

Richardson, John, Kent Bridge, Ont  
Robinson, A., Lansdowne, Ont  
Robinson, Henry, Chatham, Ont  
Robson, M., Ayr, Ont  
Ross, A., Port Perry, Ont  
Ross & Scott, Tilsonburg, Ont  
Ruttan, T. F., Prinyer, Ont

**SADLER, DUNDAS & FLAVELLE**  
MILLING CO. (The),  
Lindsay, Ont.

Proprietors of the Lindsay Flour and Saw  
Mills.

Salter, John, Hagersville, Ont  
Sanderson, John, Wroxeter, Ont  
Sheridan, John, Oakwood, Ont

**SHIPPING WAREHOUSE CO.,**  
William Wright, Mgr.  
BRADFORD, Ont.

Buyers and Shippers—Wheat, Oats, Barley,  
Peas; Hay, Rye, Clover, and Timothy  
Seeds; Dressed Hogs, etc.  
Local Dealer in Coal and Salt.

Simmons, S., Brantford, Ont  
Smith Bros., Aurora, Ont  
Spratt & Killen, Lindsay, Ont

**SPROULE, J. H. & CO.,**  
Toronto, Ont.,  
General Grain Dealers,

Barley a specialty.  
Elevator Capacity, Country Points, 300,000  
bush.; City, on G. T. Ry., 160,000 bush.  
Millers supplied with Manitoba and On-  
tario Wheat. Correspondence solicited.

Squier, J. G., Trenton, Ont  
Stark Bros. & Co., Toronto  
Stephen, C. & Co., Collingwood, Ont  
Stevens, N. H., Chatham, Ont  
Stewart Bros., Renfrew, Ont  
Stewart, Heward & Co., Orangeville, Ont

**3850. Barley, Oats and Wheat—Continued.**

**STEWART, THOS., Belleville, Ont.**

**Coal and Wood Merchant,**

**Hay, Grain, Seed and Produce.**

**STEWART BROS., Renfrew, Ont.**

**Wholesale & Retail Grain Mehts.  
(Elevator.)**

Stringer, J. B. & Co., Chatham, Ont  
Sutton, Wm., Simcoe, Ont  
Tait, Alex., Wanstead, Ont  
Tallman, Wm. & Son, Beamsville, Ont  
Taylor, T. H. Co. (The), Chatham, Ont  
Thompson, R. & A., Owen Sound, Ont  
Thomson, Walter, Mitchell, Ont  
Tiche & Stringer, Chatham, Ont  
Tiffin & Scott, Orillia, Ont  
Todd, Joseph A., Stouffville, Ont  
Touchburn, Richard, Lindsay, Ont  
Touchburn, Robert, Lindsay, Ont  
Touchburn & Preston, Bethany, Ont  
Tuffy, E., Cobden, Ont  
Uttley, J., Elmira, Ont  
Vick, George & Son, Orillia, Ont  
Wales, John, Oakville, Ont  
Wenger Bros., Ayton, Ont  
Western Milling Co. (The), Regina, N.W.T.  
Whitlaw, Baird & Co., Paris, Ont  
Wilkinson, A. W., Barrie, Ont  
Wood, W. W. B., Brantford, Ont  
Wright, A. A. & Co., Renfrew, Ont  
Wylie, John B., Almonte, Ont  
Wylie, James W., Almonte, Ont

**3851. MERCHANTS. — Buckwheat and Rye.**

Argue, T. & E., Carp, Ont  
Buckles, James, Osgoode Station, Ont  
Campbell, A. J., Arnprior, Ont  
Carruthrs, Jas. & Co., Toronto, Ont  
Coffee, L. & Co., Toronto, Ont

**COLE, F. F., Toronto, Ont**

Crane & Baird, Toronto, Ont  
Dean, N., Renfrew, Ont  
Delhay Bros., Cobden, Ont

**DE LAPORTE, A. V. & CO.,  
Toronto, Ont**

Dunnett, B. W., Kinburn, Ont

**GOODALL JAS., Toronto, Ont**

**GOULD BROS., Uxbridge, Ont**

Graham Thos., Smiths Falls, Ont  
Hall Bros., L'Original, Ont

**LAZIER, S. A. & SON,  
Belleville, Ont**

Lukes, Samuel, Bradford, Ont  
Lund, R. J., Woodstock, Ont  
Lundy, Chas., Newmarket, Ont  
Matthews, W. D. & Co., Toronto, Ont

**McBEAN A. & SON, Toronto, Ont.**

**3851. Buckwheat and Rye—Continued.**

McDougall, S., Renfrew, Ont  
McElroy, H. & Son, Carp, Ont  
McIntosh, P. & Son, Toronto, Ont  
McKay, E. P. & Co., Toronto, Ont  
McLaughlin, J. F., Toronto, Ont  
Merilees & Co., Almonte, Ont

**MERICK, S. S.,  
Carleton Place, Ont.**

Morgan Bros., Hamilton, Ont

**PEER & CO., Toronto Ont.**

Tembrock Milling Co. (The), Pembroke, Ont

**RICHARDSON, JAS. & SONS,  
Kingston, Ont.**

**ROBERTSON, JAS. Almonte Ont.,**

**SADLER, DUNDAS & FLAVELLE  
MILLING CO., Lindsay, Ont.**

**SPROULE J. H. & CO.,  
Toronto, Ont.**

Squier, J. G., Trenton, Ont  
Stark Bros. & Co., Toronto, Ont  
Touchburn, Richard, Lindsay, Ont  
Touchburn, Robert, Lindsay, Ont  
Tuffy, E., Cobden, Ont  
Vick, Geo. & Son, Orillia, Ont  
Wales, John, Oakville, Ont

**WYLIE, JAMES W., Almonte, Ont.**

**3852. MERCHANTS—Bean.**

Allan, John H. Seed Co. (The), Picton, Ont  
Bogart, N. J., Chatham, Ont  
Case, E. T., Blenheim, Ont  
Cleveland Seed Co. (The), Picton, Ont  
Colby, Geo. E., Chatham, Ont  
Cummings, Robt., Blenheim, Ont  
Glenn, Samuel & Son, Chatham, Ont  
Gilbert, M., Blenheim, Ont  
Haggart, Peter, Blenheim, Ont  
Lamont, James, Chatham, Ont

**ROBERTSON, JAMES,  
Almonte, Ont.**

Robinson, Henry, Chatham, Ont  
Stevens, N. H., Chatham, Ont  
Stringer, J. B. & Co., Chatham, Ont

**TAYLOR, T. H. CO. (The),  
Chatham, Ont.**

Tighe & Stringer, Chatham, Ont  
Tyhurst, R., Blenheim, Ont

**3853. MERCHANTS—Corn.**

Carruthers, Jas. & Co., Toronto

**COLE, F. F., Toronto.**

**DE LAPORTE, A. V. & CO.,  
Toronto, Ont.**

Glenn, Samuel & Son, Chatham, Ont



**3853. Corn—Continued.**

**RICHARDSON, JAS. & SONS,**  
Kingston, Ont.

**SPROULE, J. H. & CO.,**  
Toronto, Ont.

Stark Bros. & Co., Toronto, Ont  
Stevens, N. H., Chatham, Ont  
Stringer, J. B. & Co., Chatham, Ont

**TAYLOR, T. H. CO., (The),**  
Chatham, Ont.

Tighe & Stringer, Chatham, Ont

**3854. MERCHANTS—Hay.**

Baker & Vanatine, Brussels, Ont  
Blachford Bros., Exeter, Ont  
Bernard, Cresus, St. Basile, Que.  
Campbell, A. J., Arnprior, Ont  
Charon, Francois, jr., St. Hubert, Que  
Delahey Bros., Cobden, Ont  
Dunnett, B. W., Kinburn, Ont  
Gould Bros., Uxbridge, Ont  
Graham Bros., Smiths Falls, Ont  
Hall Bros., L'Original, Ont  
Hay, Robert, Toronto, Ont  
Honey, R., Mitchell, Ont  
Long, T. & Bro., Collingwood, Ont  
McIntosh, P. & Son, Toronto, Ont  
McGregor, J. F., Alexandria, Ont  
McKenzie, Geo., Wingham, Ont  
Merick, S. S., Carleton Place, Ont  
Morgan Bros., Hamilton, Ont  
Parker, Wm., Lyn, Ont  
Rattenbury, N. B. & M., Charlottetown, P.E.I.  
Rousseau, J. A., St. Anne de la Perade, Que  
Parrish & Lindsay, Brandon, Man  
Plews, Chas., Toronto, Ont  
Sinkann, J. N., Wellesley, Ont  
Stephens, C. & Co., Collingwood, Ont  
Thexton, R. D., Lindsay, Ont  
Thomson, Walter, Mitchell, Ont  
Tuffy, E., Cobden, Ont  
Whitlaw, Baird & Co., Paris, Ont

**3855. MERCHANTS—Peas.**

Ainsley, J. H., Port Dover, Ont  
Allan, John H. Seed Co. (The), Picton, Ont  
Allison, H. H., Adolphustown, Ont  
Andrews, T. & J., Thornbury, Ont  
Annett, James, Watford, Ont  
Argue, T. E., Carp, Ont  
Ball, O., Bath, Ont  
Beattie, James, Seaforth, Ont  
Bramm Bros., Berlin, Ont  
Brill, S. R., Teeswater, Ont  
Brink, L. A., Teeswater, Ont  
Bruce, G. F., Beaverton, Ont  
Campbell, A. J., Arnprior, Ont  
Carruthers, Jas. & Co., Toronto, Ont  
Carter, G. Son & Co., St. Mary's, Ont  
Carter, William, Guelph, Ont  
Chase, G. A., Orillia, Ont  
Chase & Frawley, Orillia, Ont  
Chisholm, H., Meaford, Ont

**2855. PEAS—Continued.**

Cleveland, Seed Co. (The), Picton, Ont  
Coffee, L. & Co., Toronto, Ont  
Cole, F. F., Toronto, Ont  
Cook, William, Meaford, Ont  
Cowdry, N. H., Lindsay, Ont  
Crane & Baird, Toronto, Ont  
Dean, N., Renfrew, Ont  
Delahey Bros., Cobden, Ont  
DeLaporte, A. V. & Co., Toronto, Ont  
Dunlop, Jas., Hamilton, Ont  
Dunnett, B. W., Kinburn, Ont  
Excelsior Roller Mills (The), Hagersville, Ont  
Finkle, R. R., Bath, Ont  
Goodall, James, Toronto, Ont  
Gould Bros., Uxbridge, Ont  
Graham, Thomas, Smiths Falls, Ont  
Hall Bros., L'Original, Ont  
Hay, Robert, Toronto, Ont  
Hewer, James, Guelph, Ont  
Hilburn & Brubacher, Berlin, Ont  
Kemp, T. O., Seaforth, Ont  
Laing, Alex., Wyoming, Ont  
Laurie, James, Seaforth, Ont  
Lazier, S. A. & Sons, Belleville, Ont  
Legett, W., Exeter, Ont  
Long, T. & Bro., Collingwood, Ont  
Lukes, Samuel, Bradford, Ont  
Lund, R. J., Woodstock, Ont  
Lundy, Chas., Newmarket  
Matthews, W. D. & Co., Toronto, Ont  
McBean A. & Son, Toronto, Ont  
McCuaig, Cheney & Co., Vankleek Hill, Ont  
McDougall, S., Renfrew, Ont  
McElroy, H. & Son, Carp, Ont  
McGinnis, W. G., Emerald, Ont  
McIntosh, P. & Son, Toronto, Ont  
McKay, E. P. & Co., Toronto, Ont  
McLaughlin, J. F., Toronto, Ont  
McRae, Peter & Co., Toronto, Ont  
Merick, S. S., Carleton Place, Ont  
Merilees & Co., Almonte, Ont  
Mitchell, T. G., Watford, Ont  
Moore, J. D., St. Marys, Ont  
Nelson & Co., Sandhurst, Ont  
Peer & Co., Toronto, Ont  
Pembroke Milling Co. (The), Pembroke, Ont  
Richardson, Jas. & Sons, Kingston, Ont  
Robertson, James, Almonte, Ont  
Robson, M., Azrout, Ont  
Ross & Scott, Tilsonburg, Ont  
Ruttan, T. F., Prinyer, Ont  
Sadler, Dundas & Flavelle Milling Co., Lindsay, Ont  
Sheridan, John, Oakwood, Ont  
Spratt & Killen, Lindsay, Ont  
Sproule, J. H. & Co., Toronto, Ont  
Squier, J. G., Trenton, Ont  
Stark Bros. & Co., Toronto, Ont  
Stephens, C. & Co., Collingwood, Ont  
Stewart Bros., Renfrew, Ont  
Thomson, Walter, Mitchell, Ont  
Tiffin & Scott, Orillia, Ont  
Todd, Joseph A., Stouffville, Ont  
Tuffy, E., Cobden, Ont  
Vick, George & Son, Orillia, Ont  
Wales, John, Oakville, Ont  
Whitlaw, Baird & Co., Paris, Ont  
Wilkinson, A. W., Barrie, Ont  
Wright, A. A. & Co., Renfrew, Ont

3856—MERCHANTS—Seed.

**BRUCE, JOHN A. & CO.,** Hamilton, Ont.

Seed Merchants.

Export Specialties.—Red Clover, Alsike Clover,  
Canadian Blue Grass and Timothy Seeds.

Evans, Robert & Co., Hamilton, Ont.  
Evans, Wm., Montreal, Que.  
Ewing, Wm. & Co., Montreal, Que.  
Ferry, D. M. & Co., Windsor, Ont.

**GOODALL, JAMES,** Toronto, Ont.

Produce Commission Merchant.

Grain, Grass, Clover Seeds, &c.

Gould Bros., Uxbridge, Ont.  
Keith, George, Toronto, Ont.  
Merrick, S. S., Carleton Place, Ont.  
Long, T. & Bros., Collingwood, Ont.  
Pearce, John S., London, Ont.  
Rennie, W., Toronto, Ont.  
Simmers, J. A., Toronto, Ont.  
Spratt & Killen, Lindsay, Ont.

**STEELE, BRIGGS SEED (The) CO. Ltd.,**

Toronto, Ont.

Seed Growers, Importers & Exporters,

Plant, Rose & Bult Growers,

Garden & Hand Tools, &c.

**ROYAL CITY SEED STORE, (The),**

New Westminster, B.C.

John King, Proprietor.

3857—HIDES & SKINS—(Green & Cured),  
Calf, Lamb, Sheep, Cow.

Appleley, A. R., Peterboro, Ont.  
Bickell & Wickett, Toronto, Ont.  
Burton, John, Listowel, Ont.  
Carrington, Joseph, Kingston, Ont.  
Chapman & Co., Pembroke, Ont.  
Clough, A. G., Ayers Flats, Que.  
Cook, H. & Co., Montreal, Que.  
Cloutier & Cie, Quebec, Que.  
Collins, Isaac, Strathroy, Ont.  
Cowards, S. M., Mitchell, Ont.  
Crain, John F., Carleton Place, Ont.  
Deguise, C., St. Geneviève, Que.  
Ewart, Wm., Smith's Falls, Ont.  
Fulton, Harlan, Halifax, N.S.  
Funnell, Jesse, Jr., Trenton, Ont.  
Goyer, B., Montreal, Que.  
Galibert, C. & Son, Montreal, Que.  
Grant, T. & Sons, Eureka, N. S.  
Hallam, John, Toronto, Ont.  
Humphrey, Nelson & Co., Hamilton, Ont.  
Jackson, G. & J., Egmondville, Ont.  
Jamieson, S., Racine, Que.

**KIMBLE, JOHN & SON, St. John, N.B.**

(Established 1872.)

Wool Pullers and Wool Merchants,  
dealers in

Hides, Calfskins and Wool Skins.

Laing, Alex., Wyoming, Ont.  
Leadlay, E. & Co., Toronto, Ont.  
Leclerc, A. & Co., Ottawa, Ont.  
Lloyd & Scully, Owen Sound, Ont.  
Long, T. & Bros., Collingwood, Ont.  
McLean, H., Ottawa, Ont.  
Mason, Wm. & Son, Dundas, Ont.  
Moss, T. & H., Pembroke, Ont.  
Munroe, D., Carleton Place, Ont.  
Murry, T. & W., Pembroke, Ont.  
Ogle, E., Orillia, Ont.  
Ott, John, Brantford, Ont.  
Price, J. & Son, Montreal, Que.  
Poole, I. & Son, Strathroy, Ont.  
Robinson, A., Lansdowne, Ont.  
Sanders, W. B., Stouffville, Ont.  
Scott, John, (Estate of), St. Catharines, Ont.  
Smith, C., Wallaceburg, Ont.  
Spring, L. L., Eastman, Que.  
Taylor, G. G., Chatham, Ont.  
Vine, James, St. Catharines, Ont.  
White, T. R., Almonte, Ont.  
Wood, James, St. Catharines, Ont.  
Wright, A., Pembroke, Ont.  
Wright, Edgar, Pembroke, Ont.

3858—TALLOW.

Bell & Co., Tilsonburg, Ont.  
Bickell & Wickett, Toronto, Ont.  
Cowards, S. M., Mitchell, Ont.  
Leadlay, E. & Co., Toronto, Ont.  
Lloyd & Scully, Owen Sound, Ont.  
Hallam, John, Toronto, Ont.  
Harris, W. & Co., Toronto, Ont.  
Taylor, G. G., Chatham, Ont.  
Vine, James, Jr., St. Catharines, Ont.

3859—HOGS—Dressed.

Annette, James, Wafford, Ont.  
Baeker & Vanstone, Brussels, Ont.  
Canadian Packing Co., London, Ont.  
Cantlon, David, Clinton, Ont.  
Carter, G. Son & Co., St. Mary's, Ont.  
Clark, Wm., Montreal, Que.  
Coleman, H., Paisley, Ont.  
Davies Co. Ltd. (Wm.), Toronto, Ont.  
DeLaporte, A. V. & Co., Toronto, Ont.  
Denne, Charles, New Market, Ont.  
Dinsley, E., Clinton, Ont.  
Evans, Samuel, Ottawa, Ont.  
Fearman, F. W., Hamilton, Ont.  
Glenn, Samuel & Son, Chatham, Ont.  
Gould Bros., Uxbridge, Ont.  
Griffin, F. W., St. Thomas, Ont.  
Gunn, Flavell & Co., Toronto, Ont.  
Harris, W. & Co., Toronto, Ont.  
Hatley, J. J., Orillia, Ont.  
Hay Bros., Listowel, Ont.  
Hogg Bros., Oakwood, Ont.  
Ingersoll Packing Co., Ingersoll, Ont.  
Laing, Alex., Wyoming, Ont.  
Laing Packing & Provision Co. Ltd., Montreal, Que.  
Lamont, Archibald, Chatham, Ont.  
Lawry, Thos. & Son, Hamilton, Ont.  
Lloyd & Scully, Owen Sound, Ont.

Masterman, A. S. & W. H., Montreal, Que.  
 Mathews, Geo. (The) Co., Peterboro, Ont. *Advt. p. 224*  
 McKenzie, Geo., Wingham, Ont.  
 McLean, W. A. & Co., Owen Sound, Ont.  
 Mitchell, T. G., Toronto, Ont.  
 Murphy, E., Mount Forest, Ont.  
 Park, Blackwell & Co., Toronto, Ont.  
 Ross & Scott, Tilsonburg, Ont.  
 Ryan, William, Toronto, Ont.  
 Rattenbury, N. B. & M., Charlottetown, P.E.I.  
 Stevens, N. H., Chatham, Ont.  
 Stringer, J. B. & Co., Chatham, Ont.  
 Whyte, John & Son, Mitchell, Ont.  
 Wylie, James W., Almonte, Ont.

**3860—IMPORTERS.**

	<i>Advt. page</i>
Bellhouse, Dillon & Co . . . . .	Montreal, Que. 264.
Benson, W. T. & Co . . . . .	Montreal, Que. 264.
Bickell & Wickett . . . . .	Toronto, Ont. 264.
Bishop, Geo. H. . . . .	Montreal, Que. 264.
Bremner, Alex . . . . .	Montreal, Que. 264.
Bushnell Co. Ltd. (The) . . . . .	Montreal, Que. 264.
Cavanagh, Edward (The) Co. . . . .	Montreal, Que. 264.
Chapleau, G. . . . .	Montreal, Que. 264.
Copland & Co . . . . .	Montreal, Que. 264.
Corby, H. . . . .	Belleville, Ont. 264.
Cormier, Z. P. . . . .	Sherbrooke, Que. 264.
Dewdney, A. H. & Bro . . . . .	Toronto, Ont. 264.
Dominion Foundry Supply Co. . . . .	Montreal, Que. 266.
Douglass, J. M. & Co . . . . .	Montreal, Que. 264.
Evans and Sons, Ltd . . . . .	Montreal, Que. 264.
Fleming, W. A. . . . .	Montreal, Que. 264.
Foisy, Thos. F. G. Piano Mfg Co . . . . .	Montreal, Que. 264.
Forman, John . . . . .	Montreal, Que. 264.
Forrester, Thos . . . . .	Montreal, Que. 266.
Fraser, Robert, S. . . . .	Montreal, Que. 264.
Hamel, Joseph & Co . . . . .	Quebec, Que.
Garland, J. M. . . . .	Ottawa, Ont.
Garneau, P. & Co . . . . .	Quebec, Que.
Henderson, Robt. & Co . . . . .	Montreal, Que. 266.
Hodgson, Sumner & Co . . . . .	Montreal, Que. 265.
Hudon, Hébert & Cie . . . . .	Montreal, Que. 265.
Hutton, James & Co . . . . .	Montreal, Que. 265.
Hyde, Francis & Co . . . . .	Montreal, Que. 265.
Laporte, Martin & Cie . . . . .	Montreal, Que. 265.
Leslie, A. C. & Co . . . . .	Montreal, Que. 265.
Macfarlane, J., Duncan & Co . . . . .	Montreal, Que. 265.
McCall, Strehyn & Co . . . . .	Quebec, Que.
McIntyre, C. J. & Co . . . . .	Montreal, Que. 265.
McLaren & Co . . . . .	Montreal, Que. 266.
McLimont, W. & Son . . . . .	Quebec, Que.
Meighen, A. & Bros . . . . .	Perth, Ont.
Montreal Printers' Supply Ag'cy . . . . .	Montreal, Que. 265.

	<i>Advt. page</i>
Montreal Stencil Works . . . . .	Montreal, Que. 265.
Morin, A. O. & Co . . . . .	Montreal, Que. 265.
Munderloh & Co . . . . .	Montreal, Que. 265.
Murdochs, Nephews . . . . .	Halifax, N.S.
Nelson, H. A. & Sons . . . . .	Montreal, Que. 265.
Nowell, B. L. & Co . . . . .	Montreal, Que. 265.
Paquet, Z . . . . .	Quebec, Que.
Pyke, Jas. W. & Co . . . . .	Montreal, Que. 265.
Rattray, D. & Son . . . . .	Quebec, Que. 266.
Robert and Compano . . . . .	Montreal, Que. 266.
Rose, J. Mackay . . . . .	Montreal, Que. 265.
Ross & Co . . . . .	Quebec, Que.
Sutherland & Campbell . . . . .	Winnipeg, Man.
Tellier, Rothwell & Co . . . . .	Montreal, Que. 265.
Thibaudeau Bros. & Co . . . . .	Montreal, Que. 265.
Thibaudeau, Bros. & Co . . . . .	Quebec, Que.
Thorpe, George A. & Co . . . . .	Toronto, Ont. 265.
Watterson & Auldjo . . . . .	Montreal, Que. 266.
Weightman Sporting Goods Co . . . . .	Montreal, Que. 265.
Wilson, Paterson & Co . . . . .	Montreal, Que. 365.

**3861—HOTELS.**

	<i>Advt. page</i>
Albion Hotel . . . . .	Montreal, Que. 266.
Arlington Hotel . . . . .	Tilsonbury, Ont. 263.
Arlington Hotel . . . . .	Warton, Ont. 267.
Balmoral Hotel . . . . .	Montreal, Que. 267.
Battersby House . . . . .	Simcoe, Ont. 263.
Brunswick Hotel . . . . .	Moncton, N.B. 267.
Brunswick House . . . . .	Wingham, Ont. 263.
Campbell House . . . . .	Napanee, Ont. 263.
Commercial Hotel . . . . .	Hamilton, Ont. 263.
Grand Union Hotel . . . . .	Ottawa, Ont. 263.
Hermann Howse . . . . .	Hepworth, Ont. 267.
Hotel Del Monte . . . . .	Preston, Ont. 263.
Hotel Dufferin . . . . .	Windsor, N.S. 263.
Lincoln House . . . . .	Grimsby, Ont. 263.
Mississippi Hotel . . . . .	Carleton Place, Ont. 263.
Oriental Hotel . . . . .	Peterborough, Ont. 263.
Paterson House . . . . .	Owen Sound, Ont. 263.
Prince of Wales Hotel . . . . .	Truro, N.S. 263.
Queen's Hotel . . . . .	Ch'lottet'n, P.E.I. 263.
Queen's Hotel . . . . .	Listowel, Ont. 263.
Queen's Hotel . . . . .	Montreal, Que. 267.
Queen's Hotel . . . . .	Port Hope, Ont. 267.
Reid House . . . . .	Hanover, Ont. 263.
Riendeau Hotel . . . . .	Montreal, Que. 267.
St. Lawrence Hall . . . . .	Brockville, Ont. 263.
St. Lawrence Hall . . . . .	Montreal, Que. 266.
Terrace Hotel . . . . .	Amherst, N.S. 267.
The Queen's . . . . .	Palmerston, Ont. 263.
Thompson House . . . . .	London, Ont. 267.
Waverley House . . . . .	Montreal, Que. 267.

**NOTE.**

This list contains a Representative List of Canada's Manufacturers and Products. Any who think there is no field for such a work are would-be-monopolists.

THE MANUFACTURERS' LIST CO.,  
 MONTREAL.

# CARRIER, LAINE & CO.,

LEVIS, P. Q.

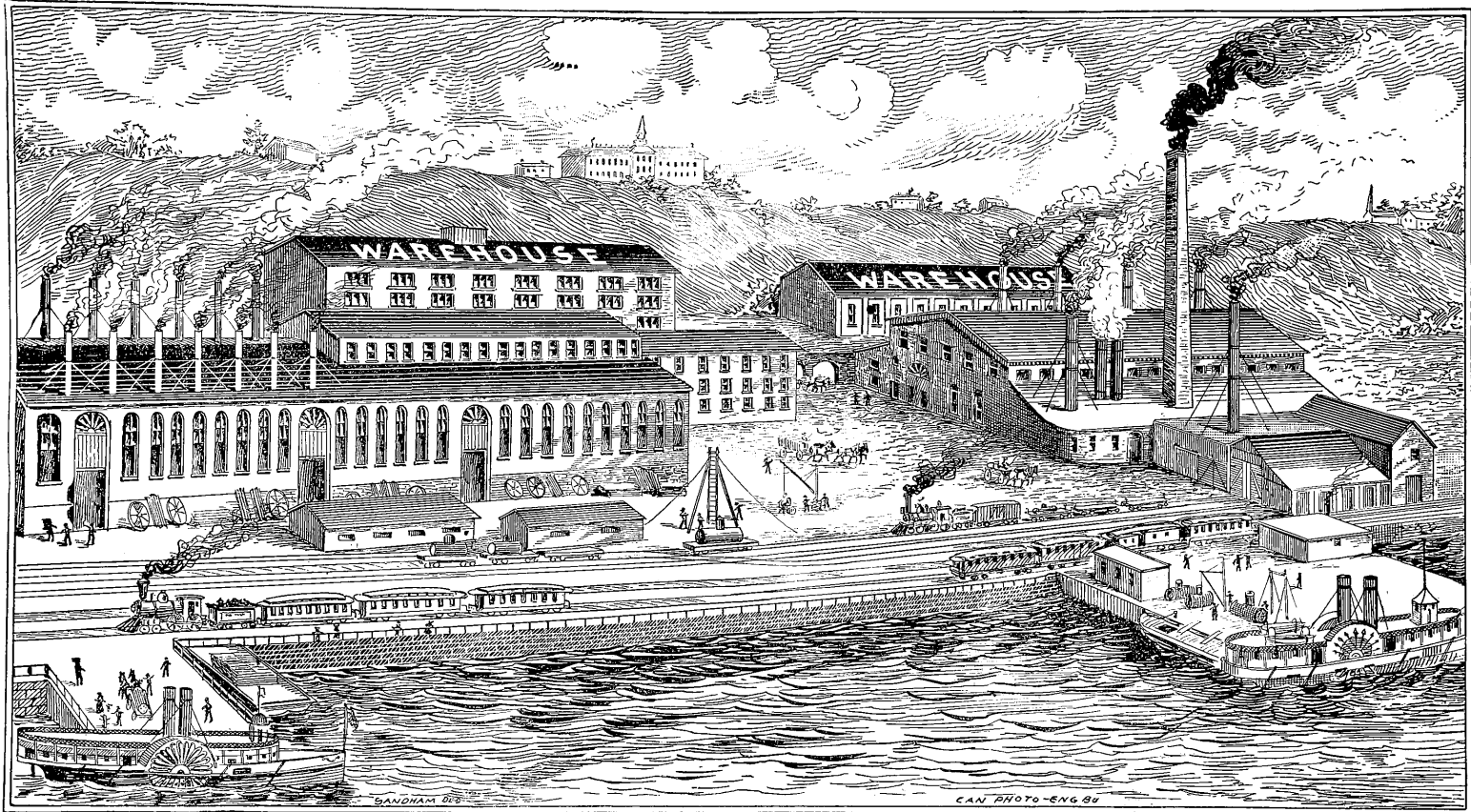

**Engineers, Founders, Machinists, Boiler-Makers, Bridge, Steamboat  
and Dredge Builders, Stove Manufacturers, General Contractors.**

*NOTE.—THE INDEX OF THIS BOOK WILL REFER YOU TO US IF WE MANUFACTURE ANY ARTICLE YOU MAY WANT.*

# The Gurney, Tilden Co., Ltd.

• • MANUFACTURERS OF • •



## “SOUVENIR”

### STOVES

### AND RANGES,



• • • AND OF EVERY DESCRIPTION OF • • •

## Cooking and Heating Stoves,

FOR WOOD AND COAL,

“PERFECT” GAS TIGHT	} FURNACES,
AND “MONARCH” HOT AIR	
	FOR COAL,

AND

## NEW HARRIS HOT AIR FURNACES,

FOR WOOD.

HOT AIR REGISTERS AND VENTILATORS,  
 HOLLOW WARE, - GENERAL CASTINGS,  
 - - - LOCKS, KNOBS, Etc. - - -

# The Gurney, Tilden Co., Ltd.,

HAMILTON, ONT.

The Largest Radiator Manufacturers under the  
 . . . British Flag . . .

"TRUTH IS MIGHTY AND MUST PREVAIL."

# Safford Patent Radiators

FOR HOT WATER AND STEAM

— — —  
 LEAD THE WORLD.

**NO** —

*Bolts, Packing, Leaks. . . . .*

**ALL** —

*Gnaranteed Carefully Cleaned.*

*Screwed Connections. . . . .*

*Tested to 180 lbs. . . . .*

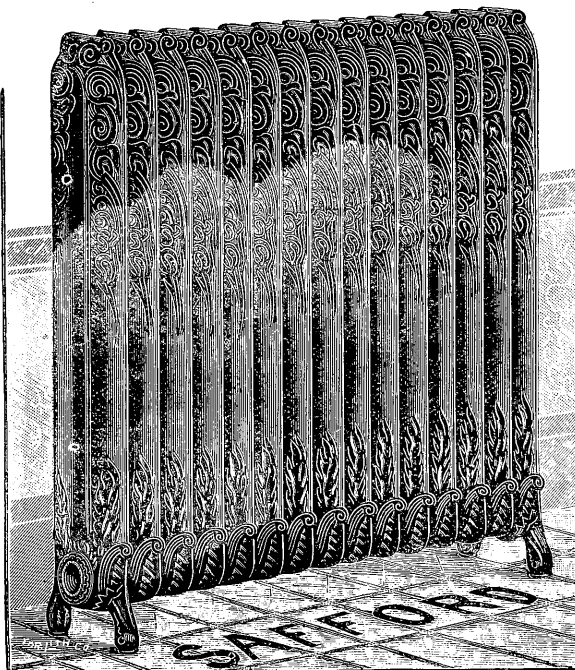

MANUFACTURERS AND EXPORTERS:

**THE TORONTO RADIATOR MF'G CO., LTD.**  
**TORONTO, Ontario.**

BRANCH WAREHOUSES:

MONTREAL,  
 QUEBEC,

ST. JOHN, N.B.,  
 HAMILTON,

WINNIPEG, MAN.  
 VANCOUVER, B.C.

# T. McAVITY & SONS,

MANUFACTURERS OF AND DEALERS IN

## Plumbers', Engineers' and Steamfitters' Goods

OF EVERY DESCRIPTION,

ST. JOHN, N.B.

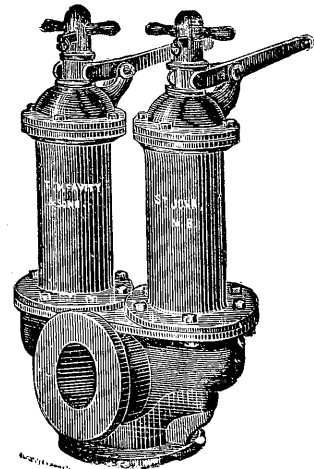
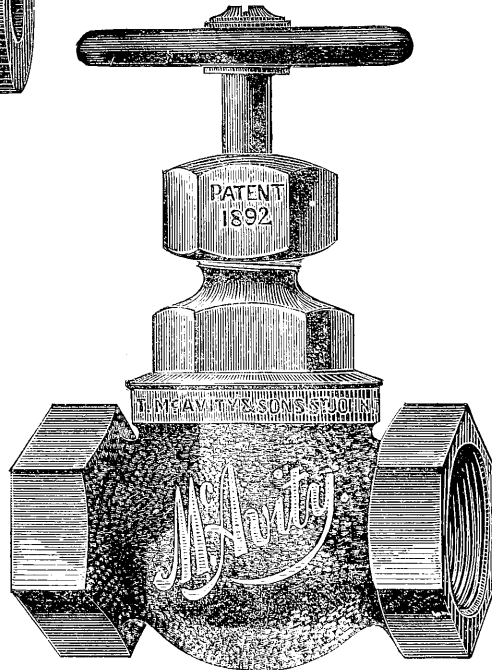
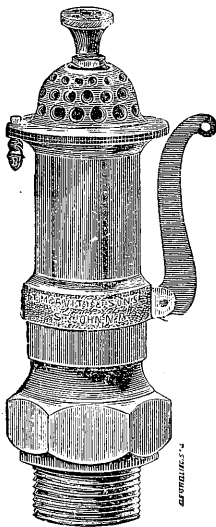
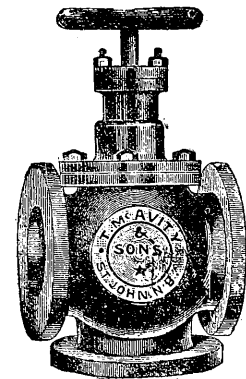
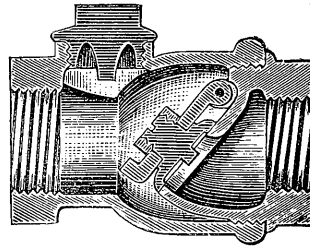
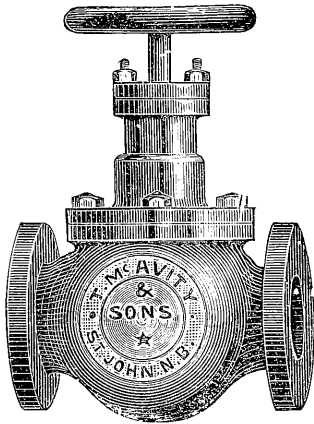
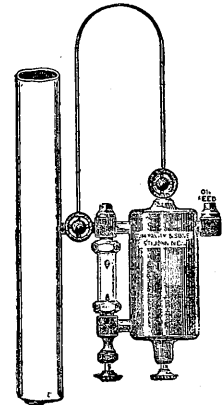
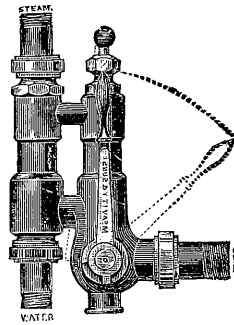
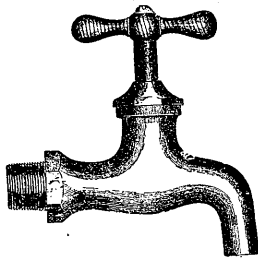

# DOMINION METAL WORKS

536 TO 542 CRAIG ST.,

**MONTREAL.**

H. W. GARTH.

GARTH & CO.

JOHN H. GARTH.

## Hot Water and Steam Engineers,

ESTABLISHED 1826.

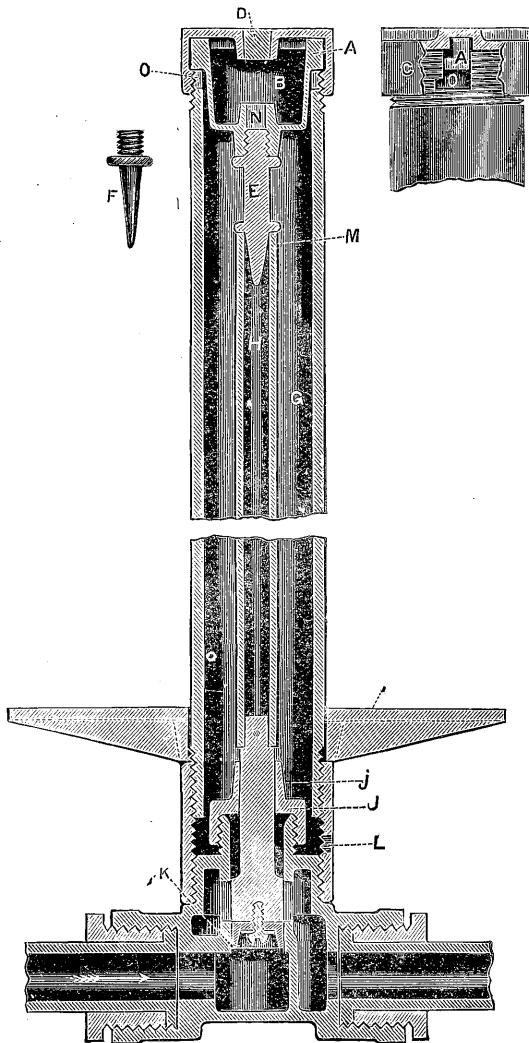

IMPERIAL STOP COCK—Section view showing water cut off.



### AGENTS FOR

- National Meter Co., New York.
- Vanduzen Steam Jet Pump, Cincinnati.
- Buckeye Bell Foundry Co., Cincinnati.
- Penberthy & Korting Injectors.
- Watson & McDaniels' Steam Specialties.
- Watson's Pressure Regulator.
- Chapman's Steam Trap Fittings, &c.
- Jenkin's Globe Valves.
- Fairbanks' Asbestos Packed Cocks and Valves.
- Chapman Valve Mfg. Co.
- Wilhelmi Copper Bath Boilers.
- Braender's Jet Pump and Water Elevator
- Fellows' Little Giant and Twin Comet Lawn Sprinklers.
- Newton's Sanitary Traps.

### SUPPLIERS OF

- Fire Departments.
- Water " "
- Railroad Supplies.
- Steamboat " "
- Electric " "
- Mill " " **Supplies.**
- Brewery " "
- Cotton and Woollen Mills " "
- Steamship " "



... MANUFACTURERS OF THE ...

**Imperial Street Stop Cock,**



**Gas Governors, Radiators.**

Cast Iron Steam Water and Soil Pipe Fittings, Malleable Iron Fittings, Bushings, Plugs, &c.; Iron and Brass Steam and Water Stop Cocks; Iron and Brass Globes, Water Valves, &c.; Steam Whistles, Steam Pumps, Injectors, Coils, Radiators, Hot Water Furnaces Sanitary Earthenware and Baths, Telsonget Iron Pipe. &c.

ESTIMATES AND PLANS FURNISHED. SEND FOR PRICE LIST.

IRON FOUNDRY.—COR. MAISONNEUVE AND LAGAUCHETIERE STS.



# The Booth Copper Co.

(ESTABLISHED 1854.)

**..COPPERSMITHS..**



— AND —

**METAL SPINNERS**



.. MANUFACTURERS OF ..

**“RESISTO”** COPPER RANGE  
♦ BOILERS. ♦

PATENTED IN CANADA AND UNITED STATES.



THE BOOTH COPPER CO.,

TORONTO, ONT.

**Steel-Clad Baths**  
BOOTH'S PATENT.

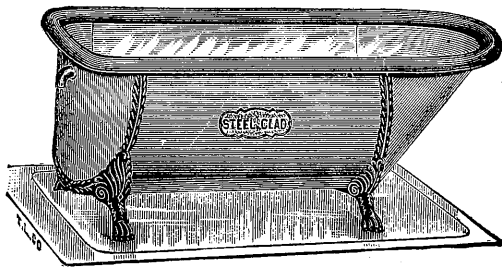

A FINISHED ARTICLE READY FOR IMMEDIATE USE.

H. McLAREN & CO., Agents,  
706 CRAIG STREET,  
MONTREAL, Que.

These Baths embrace the highest and best principles of Sanitary Science.

The price is no more than old style boxed-in bath set up.

1895 Catalogue on application.

We also carry full line of Bath Fittings, and attachments.

Correspondence Solicited.

THE TORONTO  
STEEL-CLAD BATH & METAL CO.  
(LIMITED.)

123 QUEEN STREET EAST,

A. C. BOOTH, Manager.

TORONTO, Ont.

# The Geo. Gillies Co., Ltd.

... GANANOQUE, ONT. ...

MANUFACTURERS OF

BOLTS COACH SCREWS, TIRE and FANCY BOLTS NUTS  
OF ALL DESCRIPTIONS.

FULL LINES OF

## CARRIAGE HARDWARE

GEAR IRONS, FIFTH WHEELS, STEEL TUBULAR BOW SOCKETS.

... ALSO ...

FORGINGS OF IRON and STEEL MADE TO ORDER.

# THE SWANSEA FORGING CO., Ltd,

MANUFACTURERS OF

BOLTS

Washers, Rivets, Wire Nails . . .  
 Hinges, and forgings of all kinds.  
 Herbrand Gear Irons, &c. . . . .  
 Particular attention to Bridge and  
 Roof Rods . . . . .  
 Turnbuckles, Wharf, Ship & Drift  
 Spikes or Bolts . . . . .  
 Track Spikes and Bolts, &c . . .

NUTS

NEAR  
TORONTO,

*Swansea, Ont.*

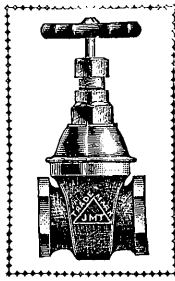

J.M.T. GATE VALVE.

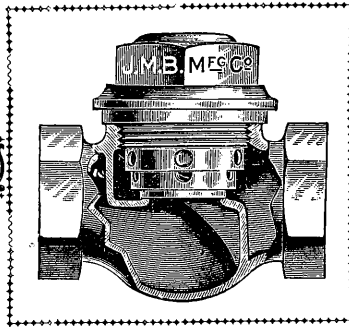

J.M.T. CUSHION CHECK VALVE.

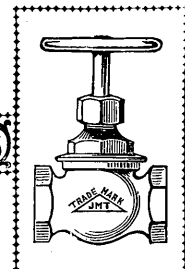

J.M.T. GLOBE VALVE.

THE . . .

# James Morrison Brass Mfg. Co., Ltd.,

MANUFACTURERS OF

Plumbers', Engineers' and  
Steamfitters' . . . . .

## BRASS GOODS

Note.—Get our "J. M. T." Valve with Special  
Metalic Disc for High Pressure.

And all descriptions of BRASS & COPPER WORK.

. . . DEALERS IN . . .

### WROUGHT AND CAST IRON PIPE

Malleable and Cast Fittings,

Plumbers' Sanitary Earthenware and Appliances, etc.

ILLUSTRATED CATALOGUE AND PRICE LIST ON APPLICATION.

# THE AMERICAN COPPER CO.



COPPERSMITHS.

. . . MANUFACTURERS OF . . .

Chandeliers,  
Gas, Electric and  
Construction.

THE LIGHTING AND FITTING UP OF  
Churches and  
Public Buildings  
A Specialty,



89 to 97 Adelaide St. West,

Toronto, Ont.

# Rhodes, Curry & Co.

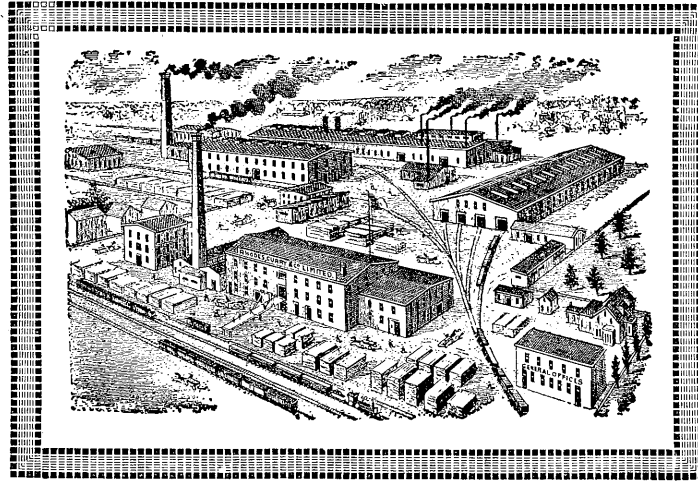

Manufacturers of 

Railway, Mining  
.... And  
Street . . . .

# CARS,

**SNOW PLOWS, FLANGERS,  
CAR WHEELS AND CASTINGS,**

.... ALSO ....

## Fittings for Banks, Schools, Stores, Offices, etc.



AND BUILDING MATERIALS  
. . . . GENERALLY . . . .



**LARGEST WORKS OF THE KIND IN CANADA.**

Write for Prices.

 **Amherst, N.S.**

# IMPORTANT TO



Manufacturers and all Parties Using Machinery.

THE

# Goldie & McCulloch Co. LIMITED.

Beg to thank the public for the long and liberal patronage extended to them and would call particular attention to the following:

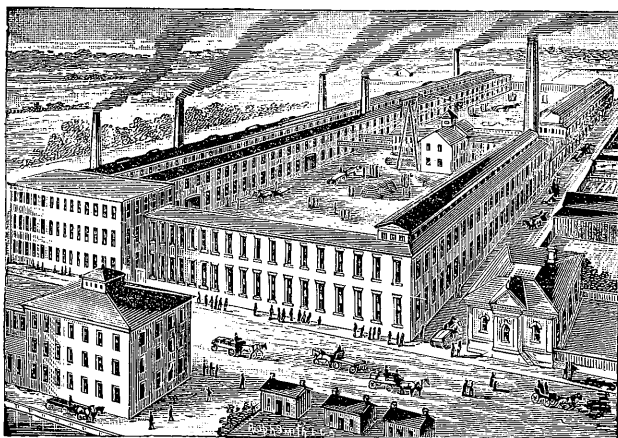

## THE WHEELOCK IMPROVED AUTOMATIC ENGINE.

This Engine has given the most complete satisfaction, and can safely be pronounced to be unsurpassed.

BOILERS,   
WITH ALL CONNECTIONS,

## Flour Mill Machinery

of the latest and most approved designs.  
Estimates furnished for new, or remodelling  
of Flour Mills. SATISFACTION GUARANTEED.

## WOOD-WORKING MACHINERY,

*Saw Mill, Shingle and Barrel Machinery, Turbine Wheels, Wool Machinery, Patent Wood Rim Split Pulleys, Fire and Burglar Proof Safes and Vault Doors, etc., etc., etc.*

 CIRCULARS WITH PARTICULARS  
FURNISHED ON APPLICATION.

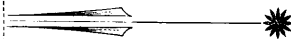

 GALT, Ontario.

W.M. J. CROSSEN,  FRED. J. CROSSEN  
 GEN. MANAGER. SEC.-TREAS.

The  
**Crossen-Car Mfg. Co.**  
**of Cobourg**

(LIMITED.)

**COBOURG, ONT.**

Builders of  
**High Class Equipment**

FOR ALL KINDS OF

**Steam and Electric  
 Railroads . . . .**

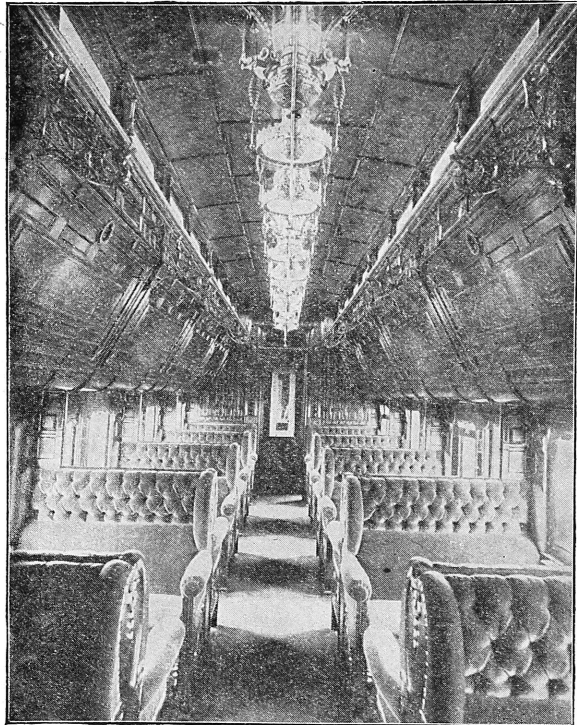

INTERIOR BUFFET SLEEPING CAR—BUILT FOR  
 INTERCOLONIAL RY.

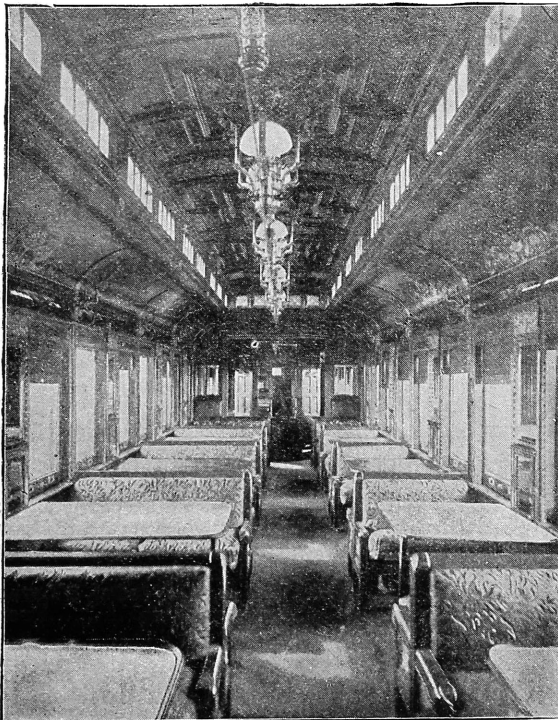

INTERIOR DINING CAR—BUILT FOR CAN. PACIFIC RY.

**Sleeping Cars,  
 Parlor Cars,  
 Coaches,  
 Freight Cars,  
 Electric Cars of all kinds,  
 Castings and Forgings,  
 Supplies for all cars.**

Special attention given to Narrow Gauge  
 Work, and Sectional Work for Export.

# John Bertram & Sons, DUNDAS, ONT.

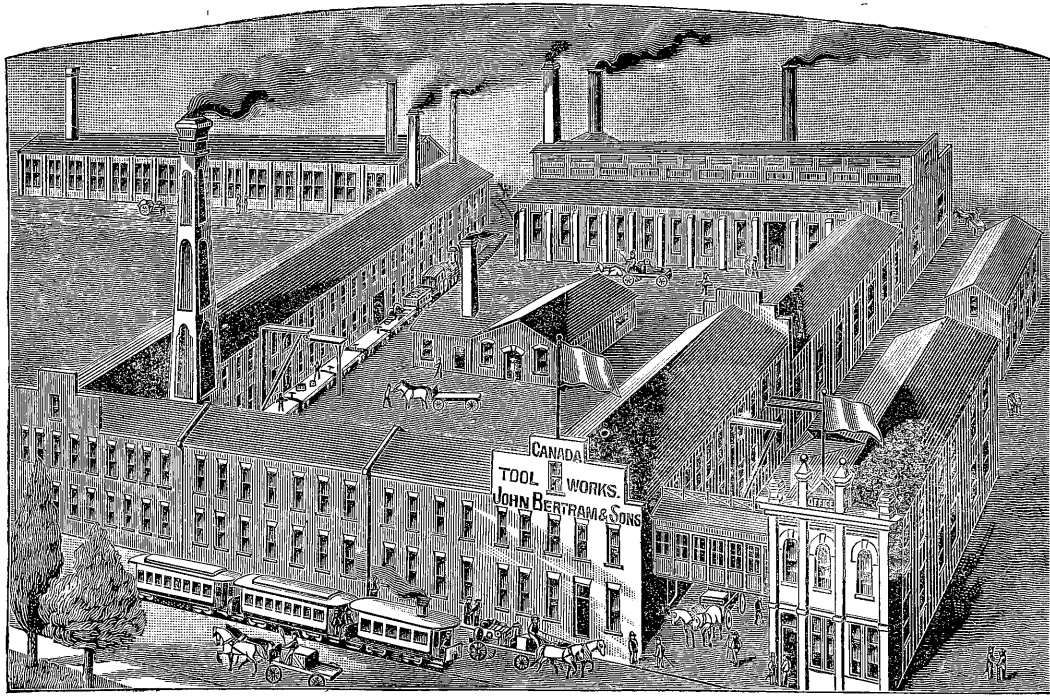

MANUFACTURERS AND BUILDERS OF

## MACHINE TOOLS for working - - IRON AND STEEL.



*EQUIPMENTS* for Machine Shops, Locomotive and Car Works, Boiler Shops, Ship Yards, Steam Forges, Repair Shops, Bridge Works, Rolling Mills, Bicycle Factories.

*WOOD-WORKING TOOLS* and *SPECIAL MACHINERY* built to order.

*AWARDS of MEDALS* at all the leading Exhibitions in Canada and abroad :

1868—Provincial Exhibition, Hamilton .....	Gold	1884—Dominion Exhibition, Montreal .....	Gold
1875—“ “ Ottawa .....	Gold	1876—Centennial Ex., Phila... Silver and Bronze	
1876—“ “ Hamilton .....	Gold	1886—Col. & Indian Ex., London, Eng.....	Bronze
1878—“ “ Toronto .....	Gold	1887—Industrial Exhibition, Toronto.....	
1879—Dominion Exhibition, Ottawa .....	Gold	1893—Worlds Fair, Chicago.... Medal, 3 Awards	
1883—Centennial Exhibition, St. John .....	Silver	1894—Quebec Industrial, Quebec.....	Bronze

**Oldest, Largest and Best Equipped Works in Canada.**

CATALOGUES ON APPLICATION.

CORRESPONDENCE SOLICITED.

THE  
**RATHBUN COMPANY**  
 DESERONTO, ONT.

**PORTLAND CEMENT**

STAR BRAND—OUR OWN MANUFACTURE.  
 GUARANTEED  
 EQUAL TO THE BEST ENGLISH BRANDS.  
 QUALITY ALWAYS THE SAME.  
 Write us for Prices and Tests.

**FLOUR**

FULL ROLLER PROCESS.

CELEBRATED BRANDS.

“CROWN JEWEL,” “DIADEM,” “WHITE  
 LILLY,” “COTTAGE,” and “STRONG  
 BAKERS,” “JUNO,” “RATHBUN’S  
 BEST,” “HASTINGS.”

BOLTED CORN MEAL.  
 BRAN, SHORTS and FEED.

**TERRA COTTA**

FOR

FIRE PROOFING AND HOUSE BUILDING. FIRE,  
 VERMIN, HEAT, COLD AND NOISE PROOF.

CHEAP AND RELIABLE.

FOR OLD AND NEW WORK.

ENDORSED BY THE LEADING ARCHITECTS.

**BRICK**

PRESSED AND COMMON,  
 HOLLOW, POROUS, OR SOLID.

FARM DRAIN TILE.

**LUMBER**

OF ALL KINDS MANUFACTURED, BOUGHT AND SOLD.

PINE AND CEDAR SHINGLES, LATH, POSTS. BILL TIMBER CUT TO ORDER.

RAILWAY TIES, PAVING POSTS,

TELEGRAPH AND ELECTRIC LIGHT POLES.

MANUFACTURERS OF SASH, DOORS, BLINDS, STAIR WORK, ALL KINDS.

MANTELS, MOULDINGS, FANCY FENCING, ALL DESCRIPTIONS OF

HOUSE BUILDING, WOOD GOODS, BARRELS, HEADING,

STAVES, HOOPS.

PASSENGER, FREIGHT AND **ELECTRIC CARS, STEAMERS AND VESSELS** BUILT AND REPAIRED.

ELECTRIC RAILWAY TRUCKS, BRILL PATENT, SOLID FORGED FRAME.

ANTHRACITE AND BITUMINOUS COAL, CHARCOAL.

DEALERS IN SALT, PLASTER PARIS, LIME, BUILDING PAPER, ETC.

CORRESPONDENCE SOLICITED.



# Myers Machine Shop.

...ESTABLISHED 1854...

M. F. & J. W. MYERS, PROPRIETORS.

ST. JOHN, N.B.

MANUFACTURERS OF

## ELECTRIC MOTORS

1-2 to 25 Horse Power.

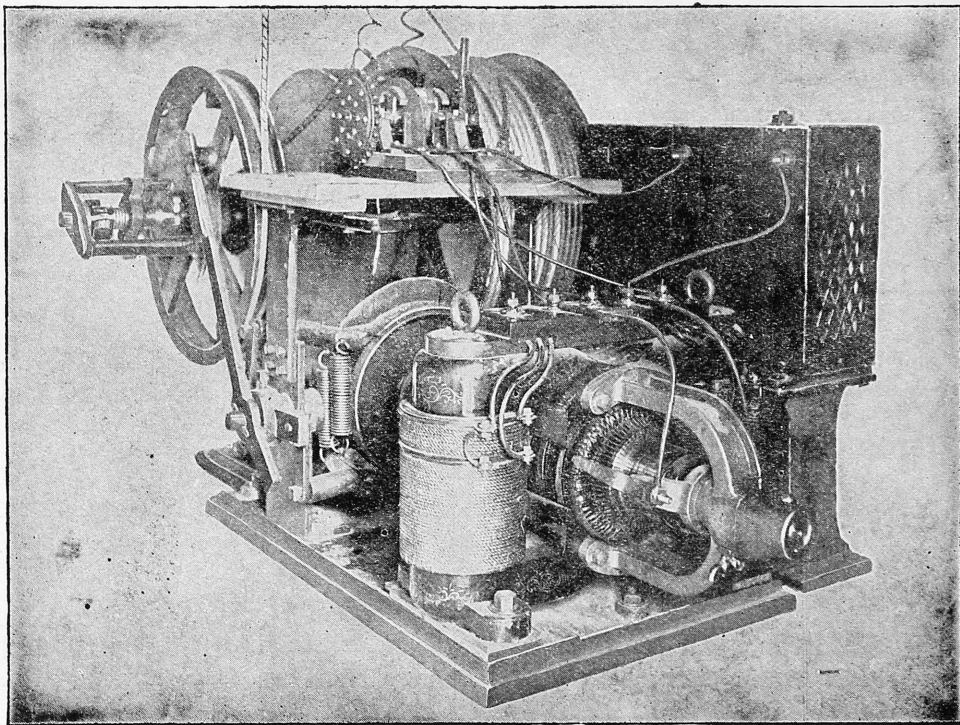

Electric, . . .  
Hydraulic, Steam  
and Hand-Power

Passenger and Goods

## ELEVATORS

VESSEL PUMPS AND STEERING GEAR,

. . . AND . . .

GENERAL MACHINERY.

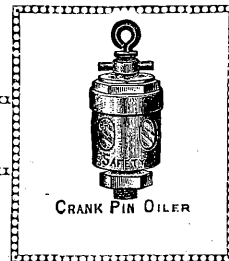
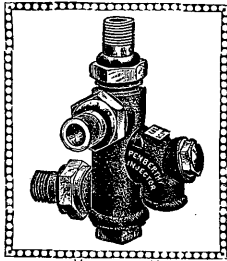

...THE....

# PENBERTHY

SPECIALTIES FOR  
THE BOILER AND  
ENGINE GIVE  
BETTER SATISFACTION  
THAN ANY OTHERS.

Our Catalogue Sent Free Tells  
all about them.

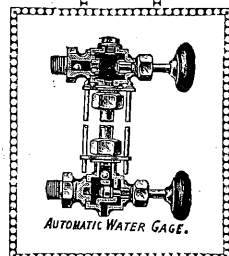
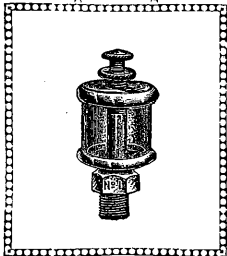

## PENBERTHY INJECTOR CO.

....DETROIT, MICHIGAN.

Branch Factory at

.....WINDSOR, ONTARIO.

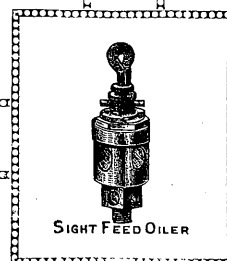
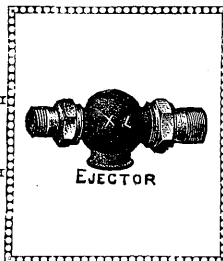

# The Fenckes Machine Co.,



— SHERBROOKE, QUE., CANADA.

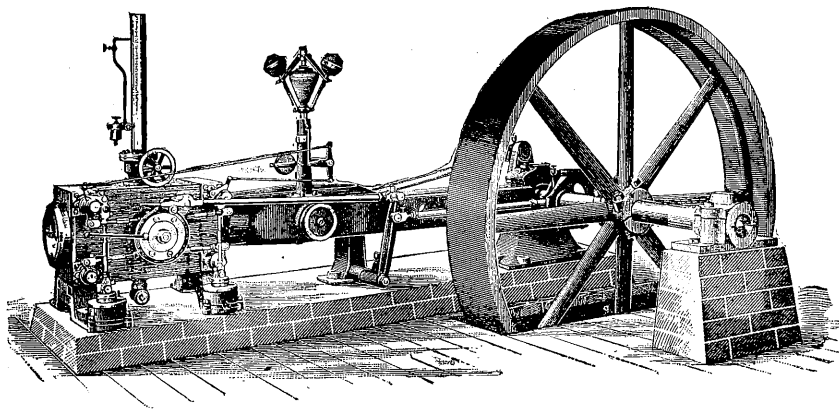

BUILDERS OF

**CORLISS  
ENGINES  
BOILERS,**

**MINING  
AND...  
HOISTING  
MACHINERY.**

*Pulp Mill Plants and Machinery for Saw Mills.*

16 Victoria Sq., Montreal. {BRANCHES} 129 Hollis St., Halifax, N.S.

# The Canadian Rand Drill Co.

SHERBROOKE, QUE., CANADA.

STEAM AND BELT  
DRIVEN

Compressors, .

Rock Drills, .

Quarry Bars, .

And...

General . . .

Mining . . .

Machinery . .

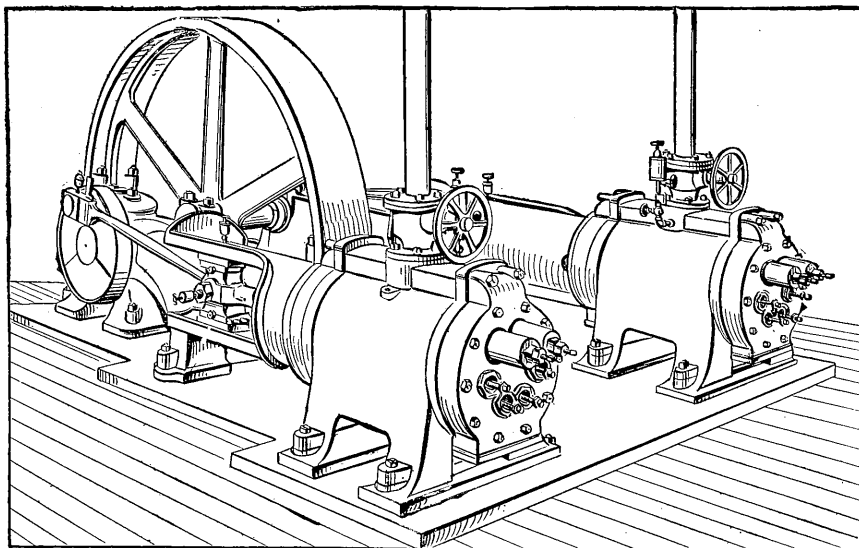

12 x 16 Belt Driven Compressor.

16 Victoria Sq., Montreal. - BRANCHES - 129 Hollis St., Halifax, N.S.

# HART EMERY WHEEL CO. LIMITED.

Specialties :

SEMI-AUTOMATIC AND  
AUTOMATIC  
Circular and Band-Saw  
Sharpeners.

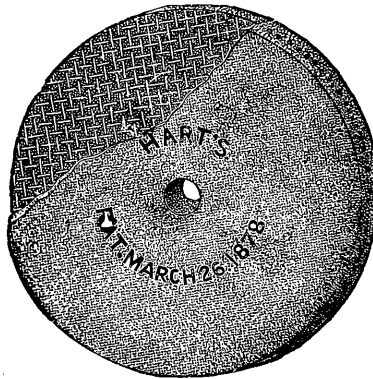

Specialties :

AUTOMATIC  
Planer Knife Grinders,  
Shiner Head Grinders,  
Moulding Bit Grinders.

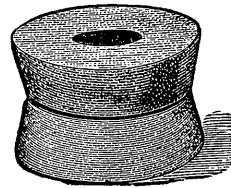
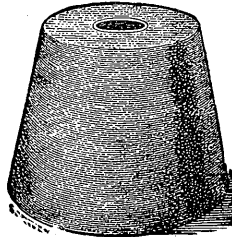
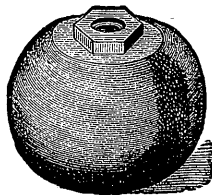

## HAMILTON, ONT.

EMERY WHEELS AND EMERY WHEEL MACHINES.

*Catalogues furnished on application.*

# The James Robertson Co. (Limited). . . . .

Lead Pipe  
 Lead Traps  
 Barb Wire  
 Wire and Bar  
     Solder  
 Window Lead  
 Drop and Buck  
     Shot  
 Tin-lined Lead  
     Pipe  
 Block-tin Pipe  
 Lead Wire  
 Pig Lead  
 Bar Lead  
 Earthenware  
 Iron Pipe  
 House Boilers  
 Ingot Tin  
 Copper  
 Boiler Plates  
 Angle Iron  
 Boiler Tubes  
 Boiler Rivets  
 Canada Plates  
 Galvanized Iron  
 Tin Plates  
 Tinware  
 Dry Colors  
 White Lead  
 Ready-mixed  
     Paints  
 Colors in Oil  
 Colors in Japan  
 Colors in  
     Distemper  
 Oxidized  
     Enamels  
 Wall Finish  
 Tube Colors  
 Varnishes  
 Whiting  
 Putty  
 Pine Tar  
 Red Lead  
 Glue  
 Resin  
 Babbit Metal  
 Baths  
 Plumbers'  
     Supplies  
 Gasfitters'  
     Supplies  
 Engineers'  
     Supplies  
 Saws  
     (All Descriptions)  
 Straw Knives  
 Files  
 Mill Supplies

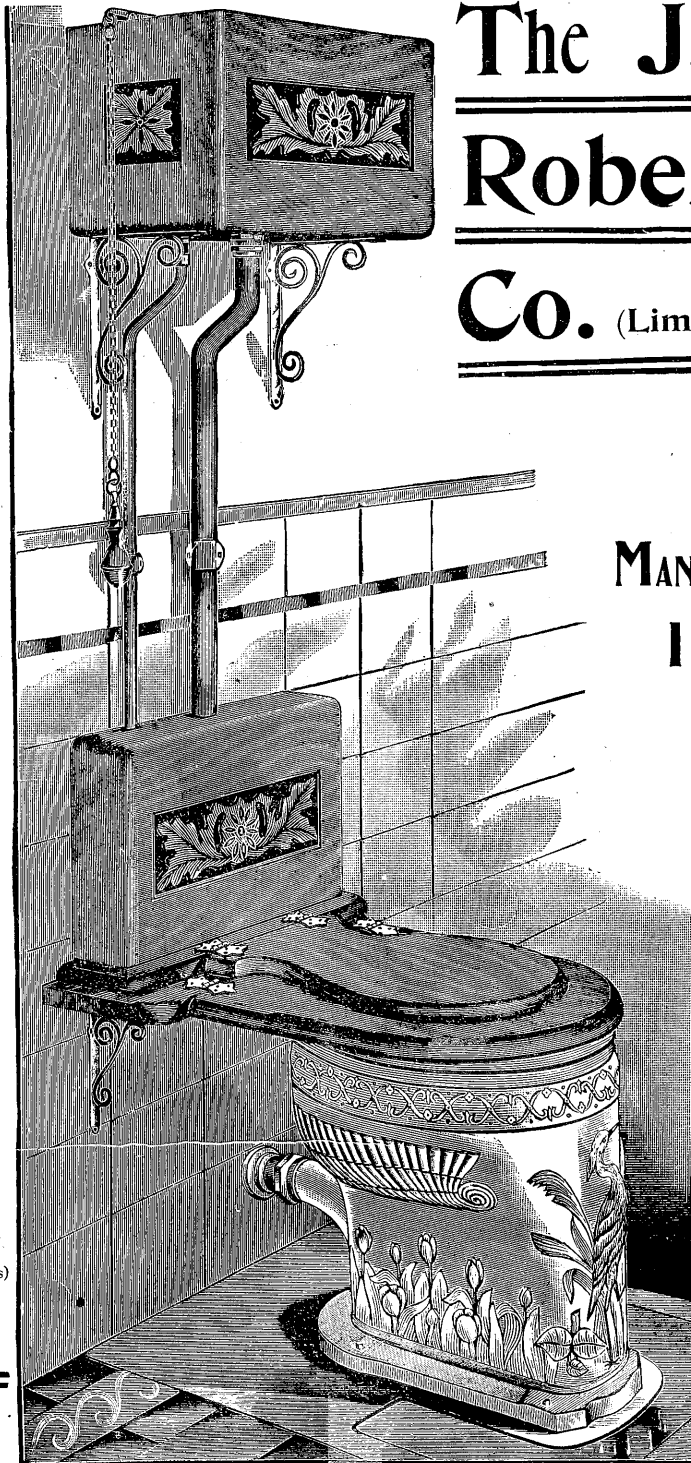

MANUFACTURERS,

IMPORTERS

.. AND ..

.. JOBBERS.

We will be pleased  
to furnish. . . . .

Prices

and . . . . .

Catalogues

on application.

MONTREAL,  
 TORONTO,  
 WINNIPEG,  
 ST. JOHN, N.B.

Robertson's Combination—Plate B.

# Above all Competitors!

Coal is money, why not save it by using the . . .

## T. J. C. INJECTOR

the most economical Boiler Feeder in the world.

**20** *per cent.* ↘

saved in coal over any other make; absolutely automatic; easily attached; applicable to all kinds of Boilers.

### **NOT EXPENSIVE.**

Will outwear any other make and is simple in construction. It is easy to operate, and is the most powerful feeder in the world.

THE

## T. J. C. INJECTOR

is the best because you cannot possibly go wrong with it. With high or low steam the result is equally satisfactory. It combines the utmost simplicity with perfect efficiency, and any boy can operate it.

	No.	PRICE.	HORSE POWER.	
Price	7	\$ 7 00	4 to 8	
	10	7 00	8 to 16	
List.	15	10 50	16 to 40	
	20	15 00	40 to 72	
	25	22 50	72 to 120	
	35	30 00	100 to 220	
	45	38 00	220 to 300	

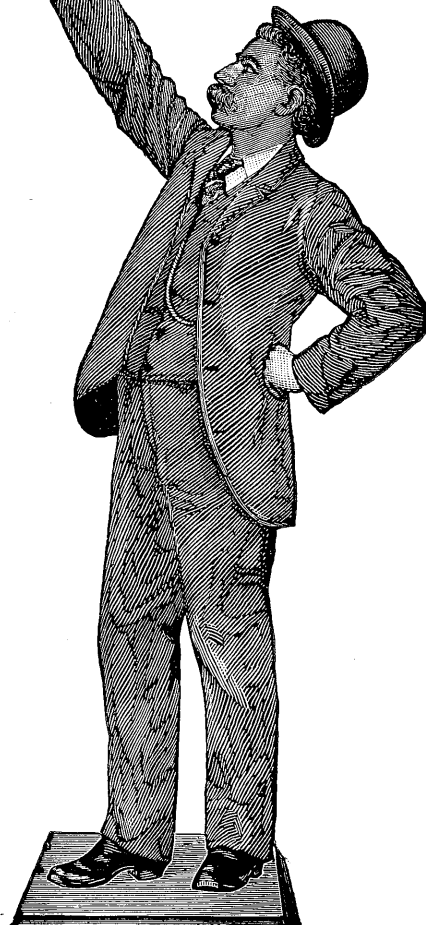
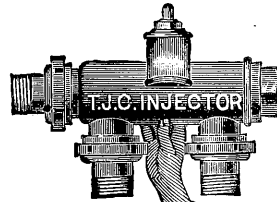

**Hamilton Brass Manufacturing Co., Ltd.**

**HAMILTON, Ont.**

# Wm. Barber & Bro.



## PAPER...

## MAKERS



... MAKERS OF ...

### *Machine Finished*

- Book Papers, . . . . .
- Lithographic & Label Papers
- Almanac & Catalogue Papers
- Colored Cover & Job Papers
- . . . .in five Colors, . . . .
- Box Covers and Linings, . .
- Paper for Coating and Card
- . . . Covers . . . . .
- Biscuit & Druggists' Blues. .
- Paper Specialties of every
- kind not made by other Mills

# GEORGETOWN, Ont.

# Buntin, Reid & Co.

... WHOLESALE STATIONERS,



## PAPER AND ENVELOPE

... MANUFACTURERS.

HEADQUARTERS FOR

### Printers' and Stationers' Supplies.

No. 1 & 2 Book Papers a specialty.

All regular sizes and weights constantly in stock, in White and Toned shades.

Coated Book Papers a specialty.

We are now offering to the trade an exceptionally fine line of Coated Book Paper, which we call our No. 1 Coated Catalogue; price 10c. per pound. This is the cheapest Coated Paper on the market. Quality A1; Samples submitted.

Boxmakers' Supplies

In Straw Board, Mill Board and an Endless variety of Box Papers in dull and glazed finish.

Poster Papers and Colored Papers,

and a large variety of all qualities of flat papers, both in Whites and Tints.

Our Envelope Factories

have the facilities for turning out special work at the very shortest notice, and we specially cater to hand-made work.

The Largest Assortment of Stationers' Staples and Novelties ever shown in Canada.

WRITE FOR PRICE LISTS OF OUR REGULAR STOCK.

ALL CORRESPONDENCE CHEERFULLY ATTENDED TO.

Warehouse & Envelope Factories: 29 Wellington St. West,

Mills:   
VALLEYFIELD, P.Q.

# TORONTO, Ont.



**CHAS. CAMMELL & Co.**  
SHEFFIELD, ENGLAND. (LIMITED.)

## STEEL RAILS,

ALL SECTIONS AND WEIGHTS.

**FISH PLATES, BOLTS AND SPIKES.**

Lowest Prices on application to

**JAMES COOPER, = = Agent,**  
164 St. James St., MONTREAL.

### JAMES COOPER,

AGENT FOR

CHAS. CAMMELL & Co., Lim., SHEFFIELD, ENG.  
*Steel Rails, Car Axles, Tyres, &c.*

JOHN HY. ANDREW & CO., SHEFFIELD, ENG.  
*Cast Steel for Tools and Drills.*

INGERSOLL ROCK DRILL CO. OF CANADA,  
*Mining Machinery, &c.*

DOMINION WIRE ROPE CO., Lim.,

ONTARIO WIRE FENCING CO.,

PATENT PLEATED ELBOW CO., Lim.

Manufacturers of the

WELLS LIGHT, 800 & 2000 CANDLE POWER.

164 St. James St., MONTREAL.

The . . . .

**Patent Elbow Co.**   
(Limited.)

MANUFACTURERS OF

THE ONE PIECE PLEATED



**Corrugated**

And . . . .

**Bisset**

# ELBOWS

• • •

164 St. James St., - MONTREAL

## JAMES COOPER,

DEALER IN

*Railway,*

*Miners' and*

*Contractors'*

# SUPPLIES

. . . ALSO . . .

Shovels, Picks, Ploughs, Mattocks, Woven  
and Barb Fencing, Press Bowl, Wheel and  
Drag Scrapers, Wheelbarrows and  
Wire Rope, &c., &c., &c.

• • •

Office : 164 St. James St., MONTREAL.

THE **DOMINION**  
**WIRE ROPE CO.**  
(LIMITED.)

MANUFACTURERS OF

# WIRE ROPE

FOR

HOISTING, MINING, UNDERGROUND HAULAGE,  
TRANSMISSION OF POWER, CANAL TOW-  
AGE, AERIAL CABLEWAYS, SHIPS'  
RIGGING, &c., &c.

ALSO

“LANG'S PATENT WIRE ROPE”

FOR UNDERGROUND HAULAGE, HOISTING  
AND COLLIERY PURPOSES.

• • •

164 St. James St., Montreal.

# Sclater.

## Asbestos Mfg. Co.

WILLIAM SCLATER. MANAGER.

35 St. Peter Street, corner Foundling,

.. MONTREAL ..



### COVERINGS.

Steam Pipe, Sectional-Block, Cement  
and Boiler.

### CEMENTS.

Magnesia, - Magnabestos, - Plastic,  
Retort, Stove Lining and Furnace.

### BUILDING MATERIALS.

Roofing, Fire Felt, Sheathing, Paper  
Mill Board, &c.

Asbestos

ENGINEERS' SUPPLIES—Packings, Oils, Waste, Rubber Hose,  
Leather Belting, &c.

GALVANIZED RANGE BOLERS a specialty.

CRUDE and FIBRIZED ASBESTOS, ex our Factory or Mine.

Proprietors—CYCLONE FIBRIZING CO'S WORKS.

TELEPHONE 494.

ST. GABRIEL LOCKS

MONTREAL.

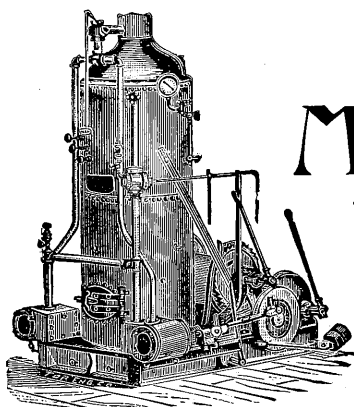

# M. BEATTY & SONS

MANUFACTURERS OF

## HOISTING ENGINES

AND

## HORSE POWER HOISTERS

(With either Clutch or Patent Friction Drums)

For Earth or Rock Work, Quarrying and Laying Stones, Mining, Pile Driving,  
Unloading Coal, Iron Ore, &c., &c.

STEAM  
• DREDGES  
DERRICKS •

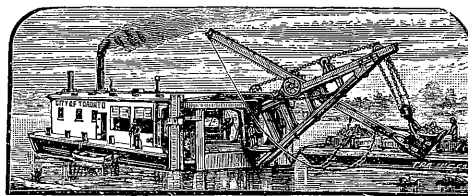

STEAM SHOVELS  
DITCHING •  
• DREDGES

## Stone Sawing Machinery

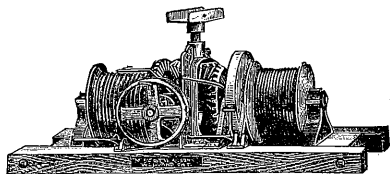

CENTRIFUGAL  
PUMPS

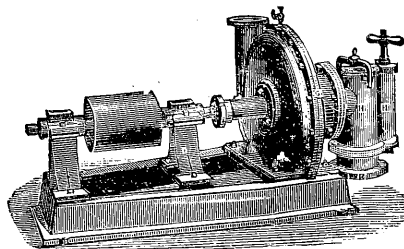

For Contractors, Quarries, Dry Docks, Wrecking and Fire Purposes, Brewers, Distillers,  
Tanners, Paper Makers, etc., also

OTHER MACHINERY FOR CONTRACTORS' AND BUILDERS' USE

Welland, Ontario

# MONTREAL ROLLING MILLS CO.

*OFFICES :*

Room 65, Temple Building,  
3080 Notre Dame St. West,  
MONTREAL.

18 Front Street West,  
TORONTO.



TRADE MARK.

*SELLING AGENTS :*

**JAMES CRAWFORD,**  
VICTORIA and VANCOUVER, B.C.

**JOHN PETERS & CO.,**  
HALIFAX, N.S.

**W. D. TAYLOR,**  
WINNIPEG, MAN.

COMPRISING :

ROLLING MILLS	}	One 18 inch train.
		" 12 " "
		" 9 " "

WIRE DRAWING MILL,

WROUGHT IRON PIPE MILL,

CUT NAIL FACTORY,

WIRE NAIL FACTORY,

TACK FACTORY,

HORSE SHOE FACTORY,

HORSE NAIL FACTORY,

LEAD WORKS AND SHOT TOWER.

Works: Lachine Canal, Montreal.

**. . The Canadian . .**  
**Locomotive and Engine Co.**  
 (LIMITED),

 BUILDERS OF —  
**LOCOMOTIVES**  
 FOR ALL PURPOSES.



Marine Engines and Boilers, Stationery Boilers for all  
 purposes, - Gas and Oil-Gas Engines, - Drakes' Patent  
 Shingle and Saw Mill Machinery, - Castings, - Forgings,  
 Pulleys, Shafting, Hangers and Mill Supplies. . . . .



Correspondence Solicited 

...

**KINGSTON, Ont.**

ESTABLISHED 1880

INCORPORATED 1883

# DOMINION WIRE MAN'F'G CO <sup>o</sup> (Limited)

F. FAIRMAN, PRESIDENT.  
 JAMES COOPER, VICE-PRES.  
 J. C. MCCORMICK, SECY-TREAS.

OFFICES: { 185 ST. JAMES ST., MONTREAL, QUE.  
 27 FRONT ST. EAST, TORONTO, ONT.

WORKS: { AT LACHINE, QUE.  
 NEAR MONTREAL.

## Manufacturers of Iron, Steel, Brass AND Copper

**MARKET WIRE**

—OF—  
 Iron and Steel,  
 Bright,  
 Annealed,  
 Oiled,  
 Coppered,  
 Galvanized,  
 Tinned,  
 —ALSO—  
 Copper, Brass  
 and Brass  
 Spring Wire.

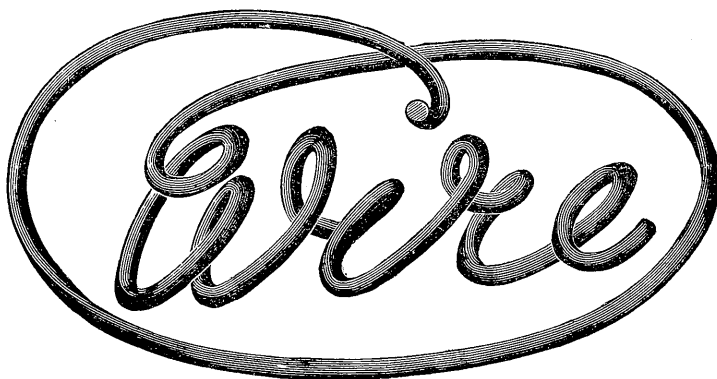

Iron and Steel  
 Tinned Wire  
 for  
 Bookbinders',  
 Broom and  
 Mattress  
 Makers' Use  
 Coppered  
 Spring Wire  
 for Mattress  
 Makers' and  
 Upholsterers'  
 Use.

**FOR ALL PURPOSES**

Wire for Nail, Rivet and Bolt Makers' Use.

Homo Rods cut to any length required.

2 and 4 Point "Lyman" Barb Wire }  
 Thorn, Ribbon, Plain Twist (2 and 3 wires) } **FENCING**

Japanned AND Coppered, Steel AND Brass "Crescent" Coat AND Hat Hooks  
 Bale Ties, Staples, Steel Spring Cotter Pins, Gate Hooks  
 and Eyes, and other Bright Goods

**WIRE NAILS** } STEEL & BRASS { **WOOD SCREWS**

• • • ALSO • • •

Galvanized Telephone and Telegraph Wire  
 Copper Wire of Highest Conductivity for Electrical Purposes

A. J. SOMERVILLE,  
PRES. & MANAGER.

T. R. WOOD,  
VICE-PRES.

JAMES GEORGE,  
SEC'Y. & TREAS.

T. S. BAYLES,  
SUPT. OF WORKS.

# Ontario Lead and Barb Wire Co.

MANUFACTURERS OF THE IMPROVED

"Lockbarb" 4-Point Fence Wire.      The Glidden 2-Point Wire,  
and Truss-Cable Fence Wire.

ALSO MANUFACTURERS OF

## WIRE NAILS,

WHITE LEAD, PUTTY, LEAD PIPE, SASH LEAD, SHOT, BABBIT METAL.  
DU BOIS SEAMLESS DRAWN LEAD TRAPS,

Made in the same manner as Lead Pipe, WITHOUT SEAMS, and of uniform thickness, smooth inside and outside. The best Trap in the World.

ADDRESS

Telephone No. 763.

### Ontario Lead and Barb Wire Co., Ltd.

WORKS: 55 & 57 RICHMOND ST.,  
NEAR CHURCH.

TORONTO, ONT.

OFFICE AND WAREHOUSE:  
54 & 56 LOMBARD STREET.

## STEAM PUMPS

OF EVERY DESCRIPTION,

... AND ...

WATER  
WORKS  
SUPPLIES.



◆ ● ◆

ONTARIO ENGINE & MACHINE CO.,

59 Richmond St. E.      Office, 122 Church St.  
TORONTO, Ont.

## WIRE NAILS

## BARB WIRE

• • •

The Western Wire and Nail Co.  
(LIMITED.)

LONDON, Ont.

# THE JAMES SMART MFG. CO.

(LIMITED.)

BROCKVILLE,  
ONTARIO, Canada.

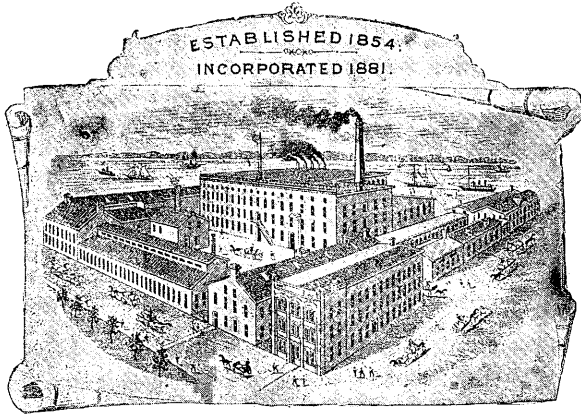

## HARDWARE

**"PERFECTION" STOVES, RANGES**  
- - - **AND FURNACES.**

Hardware Catalogue, 250 pages; Stove Catalogue, 150 pages, furnished on application to any dealer, with best trade prices.

## Street Sprinkler,

(LISCHER  
PATENT.)

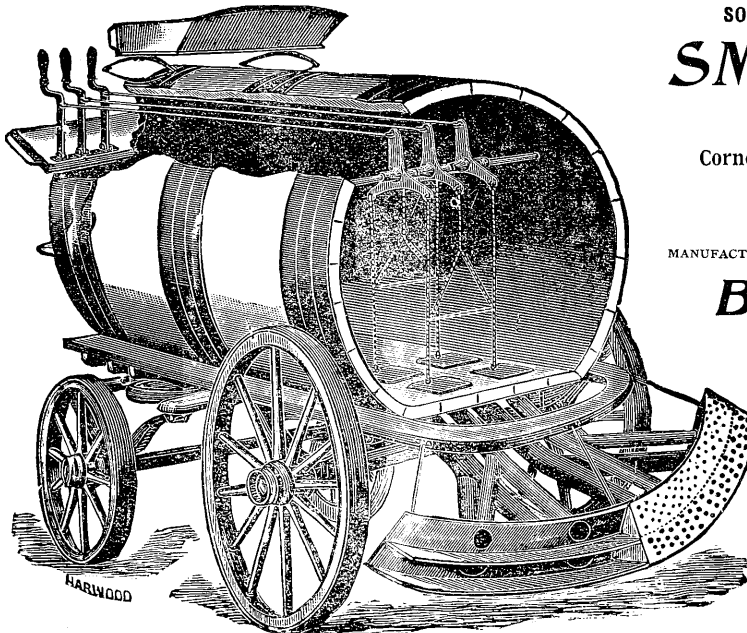

SOLE MANUFACTURERS IN CANADA:

### SMITH BROS.

(ESTABLISHED 1843)

Corner Duke and Parliament Streets,  
TORONTO.

MANUFACTURERS OF

**Buggies,**  
**Carriages and**  
**Waggons.**

Brewery Waggons, Lorries, Timber  
and Lumber Trucks, etc.,  
built to order.

**Chemical Engines and all kinds**  
**of Fire Apparatus Specialities.**

We also make a specialty of  
**Lager Beer Delivery Waggons.**



# Laurie Engine Co.

. . MONTREAL.

**ENGINEERS,  
FOUNDERS,  
CONTRACTORS.**

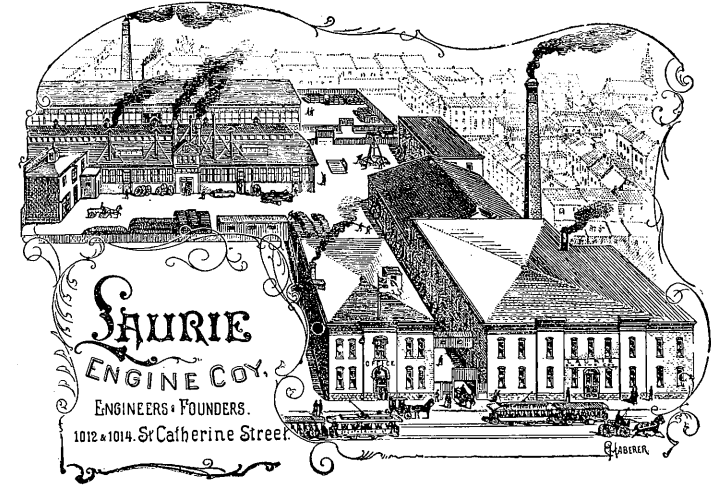

**Complete Motive Plants**

FOR ALL PURPOSES.

**Corliss Automatic Engines,**

HIGH PRESSURE, CONDENSING and  
COMPOUND CONDENSING.

**Patent Feed Water  
Heaters and Purifiers,**

◆ **Heavy Fly Wheels a specialty**

AGENTS IN CANADA FOR  
**HOLLY GRAVITY  
RETURN SYSTEM,**

AND IN PROVINCE OF QUEBEC FOR  
**NORTHEY CO., LTD.,**  
MANUFACTURERS OF

*Pumps, Condensers and  
Hydraulic Machinery.*

**PIPES.**

**PIPES.**

## THREE RIVERS IRONWORKS COMPANY

THREE RIVERS, P.Q.

**FOUNDRY AND MACHINISTS**

CAST IRON GAS, WATER and  
SOIL PIPES and necessary  
connections from two inches  
and upwards. — Hydrants. —  
Stop Valves, etc., etc., — Gen-  
eral Iron and Brass Castings.

Makers of improved Bark-  
ing. — Double Edgers. — Slab  
Splitters. — Scantling and other  
Saw Mill Machinery. — Friction  
and other Pulleys. — Couplings.  
Bearings, Gearing, etc., etc.

**PIPES.**

**PIPES.**

H. H. ROSS, PRES.

CHAS. H. HOWARD, VICE-PRES.

A. R. BEERS, SEC.-TREAS.

# The Safety Barb-Wire Co., Ltd.

- - MANUFACTURERS OF - -

**THE SAFETY BARB WIRE, THE TEXAS 2-POINT FLAT BARB WIRE**

The ordinary 4-point Barb-Wire.

Plain and Ribbon Twist Wire.

WIRE FENCE STAPLES, WIRE STRETCHERS,

- - ONLY MAKERS OF - -

## THE ROSS BRAID FENCE WIRE,

The Most Economical! The Most Durable Fancy Wire Made.

ALSO MANUFACTURERS OF

GALVANIZED WIRE CLOTHES LINES, . . . .

- - - AND - - -

ALL GOODS GUARANTEED  
BEST QUALITY AND MAKE.

† **WIRE NAILS** OF EVERY VARIETY...

ADDRESS •• The Safety Barb Wire Co., Ltd. ••TEL. 2681

WORKS NEW TORONTO. ✻ TORONTO, ONT. ✻ OFFICE AND WAREHOUSE: 50 COLBORNE ST.

## Ontario Tack Co.

HAMILTON, ONT.

MANUFACTURERS OF

### WIRE

WIRE NAILS and SPIKES.

### TACKS

BRADS and SHOE NAILS,  
and RIVETS of every size  
and description.

Sole Licensees and manufacturers of the  
**BROOKLYN WIRE NAIL MACHINE**

AND

**STARR'S PATENT  
CORRUGATED STEEL FASTENERS**

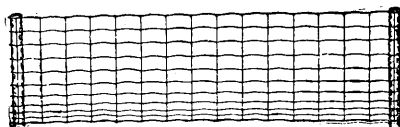

**THE PAGE**

✻ Woven Wire... **FENCE**

Leads everywhere. Adopted as standard Fence on all the leading Railroads of the United States and Canada. The favorite among Farm Fences - more miles being used each year than of any other Farm Fence. All users are well satisfied and refuse to buy other Fences. The Page has stronger wires, more of them, and tied together better than in any other Fence that can be sold as cheap. Send for Catalogue and prices.

**THE PAGE WIRE FENCE CO. OF ONT., LTD.**  
WALKERVILLE, ONT., CAN. . . . .

We also make Fine Iron and Wire Gates, Ornamental Lawn Fence, and Fence which can be used for Foot Bridges. We carry in stock Staples, Common Wire and other Supplies and Tools used in Fence Building.

We take Contracts for Fence Building.

# The Doon Linen Mills,

... M. B. PERINE & CO. ...

MANUFACTURERS OF EVERY VARIETY OF

FLAX, HEMP,  
JUTE AND  
COTTON

Twines.

FLAX AND  
RUSSIAN HEMP

Cordage.

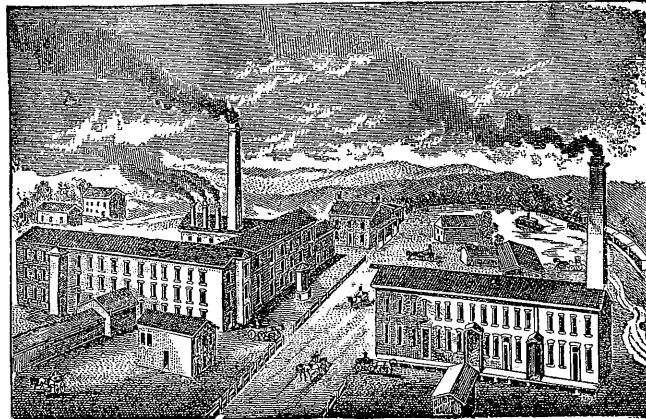

LINEN AND JUTE

Yarns.

TOW BATTING.

GREEN AND  
CARDED

Tow.

Correspondence Solicited.

DOON, Ont., Can.

## D. MORRICE, SONS & CO.

... MONTREAL AND TORONTO.

Manufacturers' Agents and General Merchants.

### The Dominion Cotton Mills Co., Ltd., Montreal.

Mills at Hochelaga, Coaticook, Chambly, Brantford, Kingston, Halifax, Moncton, Windsor, N.S., Magog (Print Works.)

Grey Cottons, Bleached Shirtings, Bleached and Grey Sheetings, Cotton Bags, Drills, Ducks, Yarns, Twines, Wicks, Prints, Regattas, Printed Ducks, Cretones, Sleeve Linings, Printed Flannelettes, Shoe Drills, &c.

### The Canadian Colored Cotton Mills Co., Ltd., Montreal.

Mills at Milltown, Cornwall, Hamilton, Merritton, Dundas, also A. Gibson & Sons, Marysville, N.B., and Hamilton Cotton Co., Hamilton,

Shirtings, Gingham, Oxfords, Flannelettes, Tickings, Awnings, Sheetings, Yarns, Cottonades, &c.

... ALSO ...

**Tweds**—Fine, Medium and Coarse; ; Etoffes, Blankets, Horse Blankets, Saddle-felt, Glove Linings.

**Flannels**—Grey and Fancy, in all Wool and Union; Ladies' Dress Flannels.

**Serges, Yarns.**

**Knitted Underwear**—Socks and Hosiery, in Men's, Ladies' and Children's.

**Cardigan Jackets**—Mitts and Gloves.

**Braid**—Fine Mohair for Tailoring, Dress Braids and Linens, Corset Laces.

**Carpet Rugs.**

THE WHOLESALE TRADE ONLY SUPPLIED.

# Corticelli Silk Co., Ltd.

## MILLS: . . .

NORTHAMPTON, Mass, U.S.  
ST. JOHNS, P.Q., Canada.  
NEW LONDON, Conn., U.S.

HARTFORD, Conn.. U.S.  
FLORENCE, LEEDS and  
HAYDENVILLE, Mass., U.S.

**MANUFACTURERS**  
OF THE  
**CELEBRATED**  
**BRANDS** OF

◆ **CORTICELLI Spool Silk and Twist, Corticelli Embroidery**  
◆ **Silk, Brainerd & Armstrong Co.'s Knitting, Crochet, and**  
◆ **Wash Silks, Arasene and Chenilles, Machine Twists, Sewing**  
◆ **Silks, Button Hole Twists, Silk Serges, Satin Linings, Art**  
◆ **Fabrics in Terrys, Brocades, Satin Sheetings, etc., Corticelli**  
◆ **Pure and Spun Silk Hosiery, Mittens and Underwear, Silk**  
◆ **Braids, Silk and Mohair Braids, and Pure Mohair Braids**  
◆ **Tubulars, Cord Edge, etc.**

## OFFICES: . . .

MONTREAL, TORONTO and WINNIPEG, Canada.  
NEW YORK, BOSTON, CHICAGO, ST. LOUIS, CINCINNATI, ST. PAUL, BALTIMORE,  
PHILADELPHIA, SAN FRANCISCO AND GLOVERSVILLE, U.S.

TELEPHONE No. 1291.

**D. PIKE,**

THE LEADING MANUFACTURER OF

 **Tents, Awnings,**  
**FLAGS AND SAILS.**

*Horse and Waggon Covers,*  
*Life Preservers,*  
*Tents to Rent*

FOR ALL PURPOSES.

*Special attention given to Family and Large*  
*Camping Parties.*

Different Grades of **CANVAS** always on hand.

157 King St. East, Toronto, Ont.

**W. H. JAGO & SON,**

 **Wool Pullers**  
and . . .  
**Tanners,**

MANUFACTURERS OF

**SHEEPSKIN MATS,**  
**DUSTERS,**

.. AND ..

ALL KINDS OF

**GLOVES AND MITTENS.**

*Rockwood, Ont.*

# PATENT ROLL COTTON BATTING



--- FOR ---

*Packing Fragile Ware and Art Goods,  
Mattress Stuffings and Linings,  
Furniture Upholstery, Cushions,  
Stair Pads, Etc., Etc.*

Three Qualities: { NORTH STAR,  
CRESCENT,  
PEARL.

SELLING AGENTS: . . . .

R. HENDERSON & CO.,  
MONTREAL.

JAS. STANBURY & CO.,  
TORONTO.

## W. H. CODDINGTON,



### Hat and Cap Manufacturer,

SPECIALTIES OF

*HATS, CAPS, HELMETS, Etc., for  
UNIFORMED SOCIETIES, BANDS,  
FIREMEN, YACHT and BICYCLE  
CLUBS, Etc., Etc.*

ALSO

*EMBROIDERY, in Gold and Silver  
Bullion, such as Badges, Wreaths,  
Lettering, Etc., for Military, Yacht  
Club, Society, and other purposes.*

PRICE LIST ON APPLICATION.

215 King Street East, HAMILTON.

**Belding, Paul & Co.**  
Limited.  
of Montreal,

Manufacture all kinds of

**Silk** Threads  
Yarns

and to order

also

**Ribbons** of all kinds.



- - Correspondence Invited.



The **St. Lawrence**  
**Steel & Wire Co., Ltd.**  
GANANOQUE, ONT.

MANUFACTURERS OF

**CORSET STEELS,**  
ALL KINDS OF **FLAT WIRE SPECIALTIES**

*Covered Flat Wire of all descriptions,  
Safety Door and Transom Locks,  
Megg's Patent Carpet Stretchers,  
Trousers Guards for Bicyclists, &c., &c.*

GENERAL CANADIAN AGENTS FOR THE

*Schott Button Making Machines and  
Button Moulds.*



Price Lists and Catalogues on application.

# The Jacob Y. Shantz & Son Co. Ltd.

... MANUFACTURERS OF ...

## FINE BUTTONS

VEGETABLE IVORY, PEARL,  
PEARLETTES, HORN.

• • •

**O**UR IVORY and PEARLETTE BUTTONS are acknowledged superior to any others manufactured or shown on the American continent.

• • •

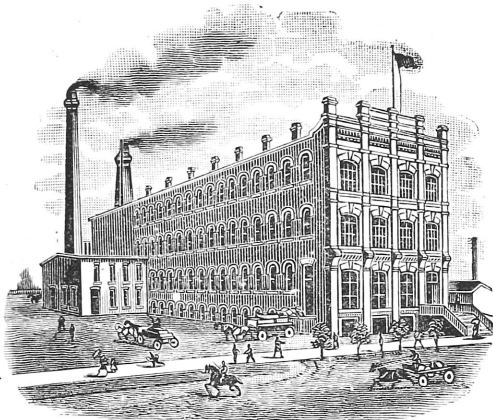

FACTORY: BERLIN, ONT., CANADA.

• • •

**FACTORIES:**

BERLIN, ONTARIO, CANADA.  
54 WELLS ST., BUFFALO, N.Y.

**THE JACOB Y. SHANTZ & SON CO. LTD.**

### **EAGLE KNITTING CO.,** HAMILTON, ONT.



TORONTO ENGRAVING CO.

MANUFACTURERS OF THE CELEBRATED BRAND OF  
**HYGEIAN UNDERWEAR,**  
In Children's and Ladies' Vests, Drawers,  
Combinations, etc. Also Gents' Balbriggan  
and Arctic Underwear.

PRESIDENT:  
J. M. YOUNG, HAMILTON.

MANAGING DIRECTOR:  
G. HUTCHISON.

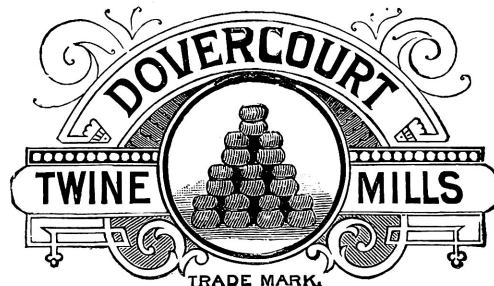

MILLS AND OFFICE: 1078 BLOOR ST. WEST. TELEPHONE 5112.  
SELLING AGENT: WM. B. STEWART, 18 FRONT ST. EAST.

**DOVERCOURT TWINE MILLS CO.**  
**OF TORONTO, LTD.**

MANUFACTURERS OF  
COTTON, JUTE, HEMP and FLAX

## TWINES AND CORDAGE

Mill Banding and Driving Ropes,  
Chalk and Fishing Lines, Seine Twine,  
Hammocks, Tennis, Cricket and Fly Nets,  
Cotton Rope and Clothes Lines. Plough Lines,  
&c., &c., &c.

# THOS. MEALEY & CO.

MANUFACTURERS OF

WADDED . . .

**Carpet Lining,**



NOVELTY . . .

**Stair Pads,**

AND

**Mattresses,**

MIXED AND ALL COTTON WOOL.

PURE CLEAN STOCK GUARANTEED.

FACTORY—DUNDAS.

OFFICE—HAMILTON, ONT.

(24 Catharine St. North.)

COBOURG MAT & MATTING  
.. WORKS ..



## WILLIAM : MITCHELL,

MANUFACTURER OF

**COCOA MATTINGS,**

All Widths and Qualities.

**COCOA MATS,**

Every Description and Size.

**Napier and Twine Mattings.**  
**Jute, Venetian and Persian Carpets,**  
**Wool Dutch and Imperial**  
**Stair and Hall Carpets.**

**Wool Rugs and Mats.**

Special Sizes, Cocoa Mats, Lettered.  
Fancy Designs, and Plain made to order.



WILLIAM MITCHELL. COBOURG, ONT.

# A. KLIPSTEIN & COMPANY,

ANILINE COLORS,

CHEMICALS AND DYE STUFFS

NEW YORK,  
PHILADELPHIA,

BOSTON,  
CHICAGO.



AGENTS FOR CANADA:

**WRIGHT & DALLYN,**

24 Catharine Street, North,  
HAMILTON, Ont

Complete Stock on hand.

The Berlin Suspender &  
Button Co. : Manufacturers,

BERLIN, ONT.

Our SUSPENDERS second to none in the market.

THE EXCELSIOR <sup>GRIP</sup> <sub>BACK</sub> BRACE AND  
TAILORS' BUTTONS

— A SPECIALTY. —

## A. BAUER & CO.,

MANUFACTURERS OF

ALL GRADES OF

UPHOLSTERERS' AND  
MATTRESS MAKERS'

## BATTINGS and FLOCKS

WATERLOO, Ont.

# Toronto Carpet Mfg. Co. Limited.

... TORONTO, ONT.

MAKERS OF

MAPLE LEAF BRAND ALL-WOOL CARPET.

STANDARD BRAND CARPET.

IMPERATRIX ADMINISTER CARPETS.

*IN BODIES, BORDERS, STAIRS, RUGS AND MATS.*

TORONTO CARPET MFG. CO., Ltd.

TORONTO, ONT.

**DOMINION ENGRAVING CO. LTD.**

WE HAVE THE LARGEST AND BEST FACILITIES FOR TURNING OUT WORK OF A SUPERIOR QUALITY AT LOWEST PRICES

phone 1204

DESIGNERS, ILLUSTRATORS, AND GENERAL PHOTO ENGRAVERS.

SAMPLES & ESTIMATES PROMPTLY FURNISHED

15 O'CONNOR ST. OTTAWA, CAN.



# The Gendron Mfg. Co., Ltd.

**TORONTO AND MONTREAL.**

Capital \$150,000

Manufacturers of

Children's Vehicles . . . . .	Close & Open Weave Hammocks
High Grade Safety Bicycles , .	Reed & Bamboo Furniture . .

WE GRADE OUR CATALOGUES AS FOLLOWS :

Grade A—Contains Children's Carriages.

“ B— “ Reed Furniture & Bamboo Novelties

“ C— “ Bicycles.

“ D— “ Velocipedes, Tricycles, Express Wagons, Dog Sulkies.

Grade D *Continued*—Toy Barrows, Doll Carriages, Rocking Horses, Shoo Fly Rockers.

“ E—Hammocks.

“ F—Sleighs.

In writing for them please mention grade required.  
Discounts will be made known on application.

FACTORY AND HOME OFFICE:

133-141 DUCHESS & 54-82 ONTARIO ST.,

**TORONTO.**

EASTERN OFFICE:

1906, 1908 & 1910 NOTRE DAME ST.,

**MONTREAL.**

# The Cork Company of Canada, Limited,

Capital:

\$150,000.00.

**Toronto and Montreal.**

MANUFACTURERS, IMPORTERS AND DEALERS IN

## CORKS and CORKWOOD

Bicycle Handles, Cork Life Preservers, Cork Dust and Shavings, Mats, Bottle Capsules, Corking Machines, Bottling Wire, Tin Foil, Willow and Cane Bottle Baskets, Bottle Racks, &c. . . . .

Catalogues and Prices mailed on application.

FACTORY AND HOME OFFICE:

42-52 ONTARIO STREET,

**TORONTO. . .**

EASTERN OFFICE:

1906, 1908 & 1910 NOTRE DAME STREET,

**MONTREAL. . .**

ENGLISH CORRESPONDENT—THE CORK COMPANY OF LONDON, ENG.

# Hamilton Cotton Co.

HAMILTON, Ont.

MANUFACTURERS  
OF  
**Cottonades,  
Denims,**

**Hosiery  
Yarns,**  
White  
and Colored,  
IN COP OR SKEIN.

**Warp Yarns,**  
Single  
and Doubled.

STAR



BRAND.

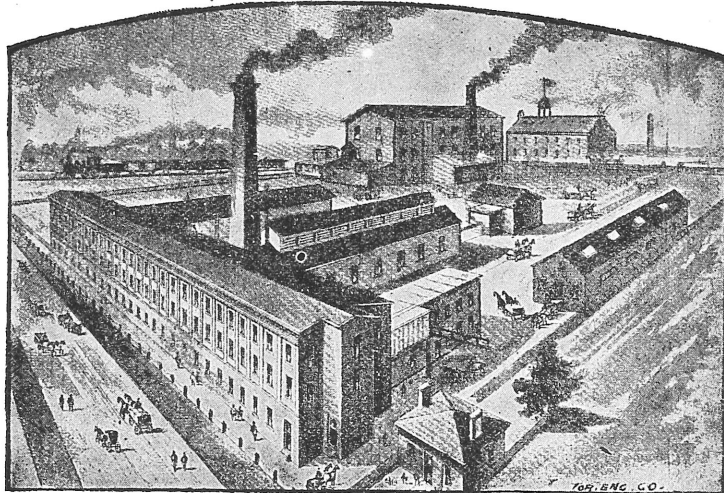

**Twine,**  
White  
and Colored.

**Lamp  
AND  
Stove Wicks,**

**Girth, Halter  
AND  
Gaiter Webs,  
etc., etc.**

STAR



BRAND.

**Dyers of Stainless Fast Black.**

## *Cascade Narrow Fabric Co.*

COATICOOK, P.Q.

MANUFACTURERS OF

**Cascade Roll Braid,**

The Best Skirt Binding Made.

**Lama Skirt Braid,**

200 Shades.

**Fine Tailoring Braids,**

**Tubular Braids,**

**Corset Laces,**

## HAMELIN & AYERS,

LACHUTE MILLS, P.Q.

MANUFACTURERS OF

**Tweeds, Blankets, Flannels, Yarns**

**Paper and Pulp Manufacturers, Felts and  
Gackets, Lubricating and Printers' Felts,  
... Linen Fire Hose and Dryer Felts ...**

... ALSO ...

**MECHANICAL PULP** from Spruce and Poplar Wood.

**SAMPLES AND PRICES ON APPLICATION.**

ESTABLISHED 1868.

## JOHN HOPE & CO..

.... LACHUTE, Que.

MANUFACTURERS OF

**SHUTTLES, BOBBINS, SPOOLS.**

**Skewers, Picker Sticks, Cloth Rolls,  
Paper Mill Plugs, Button Moulds.**

AND ALL KINDS OF

**WOOD TURNINGS.**

Orders by Mail promptly attended to.

# THE W. J. GAGE CO. LTD.

*Educational Publishers*  *Wholesale Booksellers, Stationers, and Paper Dealers*

... MANUFACTURERS OF ...

**ENVELOPES**—Court, Commercial, Counter, Legal, Official, &c. Special sizes made to order.  
**BLANK AND MEMO. BOOKS** of all kinds. Books of any size or pattern made to order.  
**COMMERCIAL BLANK FORMS**, Notes, Drafts, Receipts, &c.  
**BOOKKEEPING BLANKS** and School Blanks of every description. Exercise, Composition, Dictation, Work, Writing, Scribbling, Note, Practice Books.  
**WRITING TABLETS**, Scribbling Pads, Reporters' Note Books, Book Covers, Liquid Slating, Numeral Frames.

SAMPLES, QUOTATIONS AND ESTIMATES PROMPTLY FURNISHED.

52-54 FRONT ST. WEST, TORONTO, ONT.

## WHALEY, ROYCE & CO.

Music Engravers

AND PUBLISHERS.

Manufacturers and Importers of everything Musical.

SPECIALTIES:

The 'Imperial' Band Instrum'ts  
 Guitars, Mandolins,  
 'Duplex' Drums and Banjos,  
 Fairbanks & Co.'s Banjos,  
 Band Caps and Uniforms,  
 Band, Orchestra & Sheet Music,

Write for Catalogues, mentioning goods required.

We want the address of every Music Teacher, Bandmaster and Band Secretary in America.

**WHALEY, ROYCE & CO.,**

158 Yonge St., TORONTO, Canada.

## RITCHIE & RAMSAY,

MANUFACTURERS OF

Coated Papers & Cardboards

P. O. BOX 565, TORONTO.

SPECIALTIES:

Coated Chromo, Litho and Book.  
 Coated Duplex Art and Cover.  
 Surface and Glazed.   
 Alkali-proof Soap Wrapper Papers.  
 Pasted Printers' Blanks.  
 Coated Litho and Calendar Blanks.  
 Photo Mount Boards.  
 Translucent and Pasted Bristol.  
 Folding Box Boards.

## The Rolland Paper Co.

MILLS AT ST. JEROME, P. Q.

MANUFACTURERS OF

TUB SIZED AND LOFT DRIED

Ledger and Writing **PAPERS,**

AZURE, WHITE or CREAM.

ENGINE SIZED BOOK AND WRITING PAPERS.

Special Grades and Sizes made to order.  
 Paper Ruling in all Branches.

• HEAD OFFICE, MONTREAL,

.. It Makes the Carpet , .  
**WEAR BETTER, FEEL BETTER,  
 LOOK BETTER.**



**The FOLDED PAPER . . .  
 CARPET LINING**

saves more than its cost every year in the wear of the Carpet. It is three thicknesses of heavy paper folded in such a way that the folds absorb the dust that sifts through the carpet.

Costs no more than other Carpet Linings.  
 When you buy your next Carpet Lining be sure that it is the **Folded Paper Carpet Lining.**

**For Sale by Best Carpet Dealers.**

**Insist** on having the "Folded Paper Carpet Lining" and if your dealer will not supply you, it can be ordered direct from the factory in any quantity over 20 yards.

**FREE**—A sample large enough to show its value will be mailed free to any address.

**S. A. LAZIER & SONS,**  
 Sole Manufacturers . . . for Canada, **Belleville, Ont.**

THE CELEBRATED

**“OTTO  
 HIGEL”**



Pianoforte  
**Action**

Gives the best satisfaction wherever used.

When buying a Piano be sure to have one in it.

Absolutely the highest grade Piano Action of this age.

OTTO HIGEL,

MANUFACTURER.

OFFICE and FACTORY:

91 & 93 Richmond  
 St. West.

**Toronto, Ont.**

# J. FORD & CO.

... MANUFACTURE ...

Manilla and Brown Wrapping  
News, Lining and Wall . . . **PAPERS**

.. Strawboard—Plain and Lined ..  
.. Woodboard and Wood Pulp ..  
Roofing, Carpet and Lining Felts.  
.. and STRAW SHEATHING ..



## PORTNEUF, P.Q.

TELEPHONE NO. 2.

P. O. Box 3.

**The Valleyfield Foundry and  
Machine Works.**

**M. O. DESPOCAS, PROPR.**

MANUFACTURER OF

*Iron, Brass and Copper Casting, Shafting, Hangers,  
Pulleys. Also, Friction Clutch Pulleys, Napping,  
and Beaming Machines, Section and Loom  
Beams, Church and School Seats, &c.*

ALL KINDS OF CONTRACTOR WORK.  
HEAVY WORK ON SHORTEST NOTICE.

Particular attention paid to Repairs.

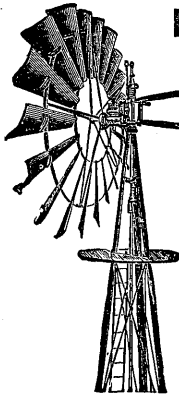

**BRANTFORD**

...STEEL...

**Wind Mills,**

GALVANIZED.

**For Pumping and Power.**

Galvanized  
Steel Towers  
and Wheels,  
The best in America.  
Ideal Spray Pumps,  
Iron Pumps,  
Water Tanks,  
Piping, etc.



**Wall..** Decorations from the  
Cheapest Brown Blanks  
... up to the most ..

**ARTISTIC EMBOSSED  
GILTS and INGRAINS.**

WITH ONE AND TWO BAND FREIZES.

**NEW DESIGNS.**

**NEW COLORINGS.**

If our Travellers do not reach you, your  
Sample request will have our attention.

Ask your dealer for our  
goods. The firm's name  
on the margin of each roll.

# Paper

...

**Colin McArthur & Co.**

1030 Notre Dame St. **MONTREAL.**

**THE BARBER & ELLIS CO. LTD.**

MANUFACTURERS OF

**ENVELOPES & PAPER BOXES.**

WHOLESALE DEALERS IN

WRITING PAPERS of all kinds,  
BILL HEADS, STATEMENTS, NOTE PAPER, RULED and PACKED in OUR FACTORY.

***Our Envelope Works***

ARE THE ONLY COMPLETE FACTORY IN THE DOMINION  
FOR THE MANUFACTURE OF ALL KINDS OF ENVELOPES.

SELLING AGENTS FOR

**THE ROLLAND PAPER CO'Y,**

The only makers in Canada of TUB SIZED and LOFT DRIED PAPERS.

Nos. 43, 45, 47, 49 Bay Street,

*Toronto, Ont.*

**STEINHOFF & GORDON,**

MANUFACTURERS OF

PATENT

**HOOPS,  
STAVES  
and HEADINGS**

OF EVERY KIND.

***Wallaceburg, Ont.***

**MILLER BROS. & CO.,  
Collar and Box Factory,**

MANUFACTURERS OF

Fine Linen Faced Collars and Cuffs,  
Paper Boxes of every description, Egg Cases, Etc.  
30 to 38 Dowd St., MONTREAL, Que.

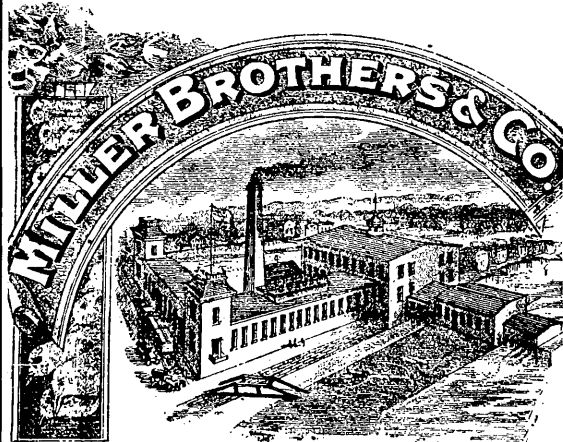

Glen Miller Pulp and Paper Mills,  
GLEN MILLER, NEAR TRENTON, ONT.  
Manufacturers of STRAW BOARD, WOOD BOARD,  
BUILDING BOARD, ROOFING FELT, Etc.  
TORONTO BRANCH: G. B. FRASER, AGENT, 42 SCOTT STREET, TORONTO.

# CLAPPISON PIPE AND BOILER COVERING CO.

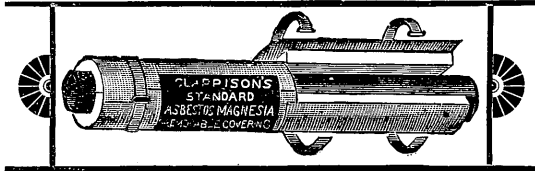

MANUFACTURERS OF

## Clappison's Standard Asbestos Magnesia Sectional Covering,

For Steam Pipes, Boilers, Domes, Heaters, Tanks, Stills, etc. The best non-conductor and handsomest appearing Covering in the market, and the only Company in Canada that makes fittings for covering Elbows, Tees, Globe Valves, etc.

**Asbestos Goods** of every description, including Cement, Packing, etc.

Contractors for Covering Marine and Stationary Boilers, Heaters, Pipes, etc.

Estimates furnished upon application. Write for Catalogue and Price List.

54 & 56 ALANSON ST., HAMILTON, ONT.

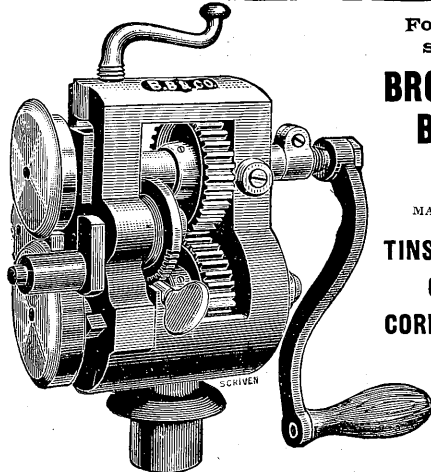

SOLID FRAME SMALL MACHINE.

## Tools and Machines

... ALSO ...

DIES, PRESSES, ETC.

HAMILTON, = Canada.

For prices send to  
**BROWN, BOGGS & CO.**  
MANFRS. OF  
TINSMITHS',  
CANNERS',  
CORNICEMAKERS'  
...AND...  
RANGEMAKERS'

# THE HAMILTON ENGINE PACKING CO.

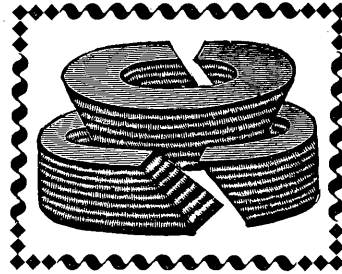

MANUFACTURERS

CLAPPISON'S IMPROVED

EXPANSION RING, SECTIONAL RING AND COILPACKINGS.

EXCLUSIVE AGENTS IN CANADA FOR

THE SMITH ADJUSTABLE RAINBOW GASKET,

FOR MAN AND HAND HOLES.

54-56 ALANSON ST., HAMILTON, ONT.

Rainbow Sheet and Gasket, Vulcanizing Plumbago, Wire Insertion and Common Rubber Sheet Packings, Square Flax Water Packing, Asbestos Wick and Millboard; Eureka, Peerless and Square Metallic Wound Asbestos Packings, for High-Pressure Engines, Lace Leather, Flue Scrapers, Cotton Waste, etc., etc.

# HAMILTON FACING MILL CO., LTD.

... MANUFACTURERS OF ...

FOUNDRY FACINGS,  
CORE COMPOUND,  
CEYLON PLUMBAGO,  
And all kinds of ...  
FOUNDRY SUPPLIES.

... SHIPPERS OF ...

MOULDING SAND,  
FIRE BRICK  
And ...  
FIRE CLAY.



OFFICE AND MILLS:

HESS ST. N., HAMILTON, ONT.

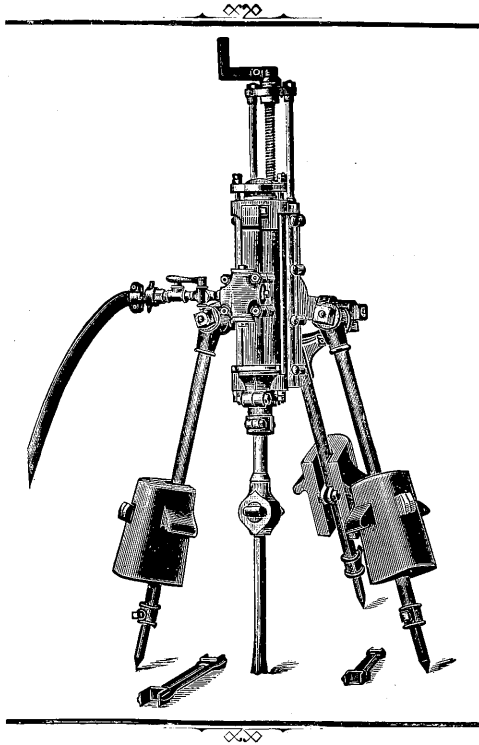

— THE —  
**Mac Machine Co'y,**

**BELLEVILLE, ONT.**

**Iron & Brass Founders.**

MANUFACTURERS OF

ROCK DRILLS, . . .



AIR COMPRESSORS,



HOISTING ENGINES.

. . . AND . . .

**Mining and Quarrying Machinery.**

**OVER 1,600,000 HORSE POWER OF THE  
 BABCOCK & WILCOX WATER TUBE STEAM BOILERS**

**. . . ARE IN SUCCESSFUL USE . . .**

WM. T. BONNER,  
 General Agent for Canada.

**HEAD OFFICE:** 415 Board of Trade Bdg.  
 MONTREAL.

CANADIAN SHOPS.  
 BELLEVILLE, ONT.

Large Book on Steam sent free on application.

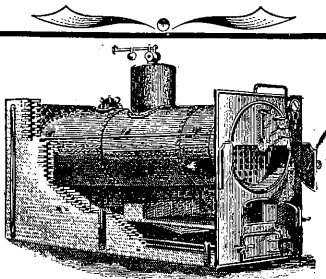

**JOHN PATTERSON,**

. . . MANUFACTURER OF . . .

**STEAM BOILERS,**

FOR MARINE AND LAND PURPOSES.

**IRON SHIPS REPAIRED** AND ALL KIND OF **SHEET IRON WORK**

488 and 490 UPPER WATER STREET,

Estimates given  
 on application.



**HALIFAX, N.S.**

**THE GOUBERT WATER TUBE FEED WATER HEATER**

Built in all sizes from 50 to 6,000 Horse Power. Is EASILY CLEANED, DURABLE and CHEAP.

**THE STRATTON SEPARATOR,**

For REMOVING ALL ENTRAINED WATER FROM STEAM.

Send for Catalogues.

**THE GOUBERT MFG. CO., SOLE MANUFACTURERS.**

WM. T. BONNER, Genl. Agent for Canada.

Head Office, 415 Board of Trade, MONTREAL.



J. C. ROBERTSON,  
PRESIDENT.

S. H. HAYWARD,  
VICE-PRESIDENT.

JAMES MOWAT,  
TREASURER.

THE  
**Portland Rolling Mills Co.**

(LIMITED.)

SUCCESSORS TO

J. HARRIS & Co., ESTABLISHED 1828. S. R. FOSTER & SON, ESTABLISHED 1858.

MANUFACTURERS OF

Refined and Common Bar Iron,  
Rivet Iron, Car Axles, . . . . .  
Shaped Car Truck Bars, . . . . .  
Hammered Shafting, . . . . .  
Steel and Iron Nail Plate, . . . . .

Street and Mine Rails, . . . . .  
Fish Plates, Railway Spikes, . . . . .  
Cut Steel Nails and Spikes, . . . . .  
Clinch Nails, Tacks, Brads, . . . . .  
Shoe Nails, etc. . . . .

Office and Mills :  
STRAIT SHORE,

St. John, N.B.

**Dominion Bridge Co., Ltd.**

MONTREAL, P. Q.

Builders of

RAILWAY and HIGHWAY BRIDGES of all Designs in IRON and STEEL, PLATE and LATTICE GIRDERS, PIN and LINK or RIVETED TRUSS WORK, TRESTLES, SWING BRIDGES, TURN-TABLES, ROOFS, ELECTRIC POLES, HOUSE GIRDERS, TRUSS RODS, EYE BARS, FORGINGS, and all kinds of STRUCTURAL METAL WORK FOR BUILDINGS.

Dealers in

STEEL BEAMS, ANGLES, TEES, CHANNELS, PLATES, ROLLED EDGE FLATS, BARS, RIVETS, Etc.  
IRON BEAMS, TURNBUCKLES, RIVETS, Etc.

Works at Lachine Locks, P. Q. (Dominion Station, G. T. R'y.)

P. O. Address : MONTREAL, P. Q.

**ABBOTT & CO.**

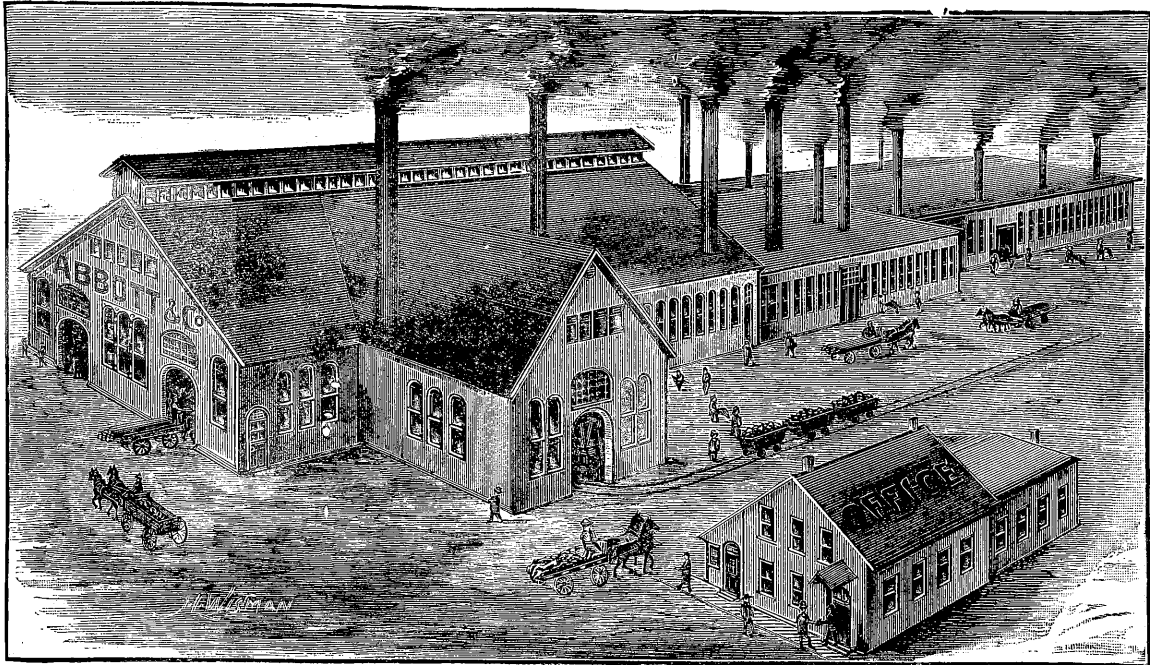

**ROLLING MILLS, MONTREAL.**

**DOMINION  
CARTRIDGE  
COMPANY,  
MONTREAL.** LTD.

MANUFACTURERS OF HIGHEST GRADES

**AMMUNITION**

FOR SPORTING, MILITARY AND TARGET  
RIFLES, REVOLVERS, ETC.

**PAPER SHOT SHELLS,**  
LOADED AND EMPTY.

**BRASS SHOT SHELLS,  
PRIMERS, ETC.**

DOMINION AMMUNITION CAN BE PROCURED  
FROM RELIABLE HARDWARE AND  
SPORTING-GOODS DEALERS.

**QUALITY GUARANTEED UNEXCELLED.**

**Hamilton Powder Co.**

MANUFACTURERS OF

**EXPLOSIVES.**

Dominion Agents for ...

**Ensign Bickford Safety Fuse,**

**The Smith Electrical Co's -**

**Blasting Apparatus, Etc. - -**

••

OFFICE:

103 St. Francois Xavier Street,  
**MONTREAL.**

BRANCH OFFICES AND MAGAZINES AT

**TORONTO, HAMILTON, PORT ARTHUR, WINNIPEG,  
VANCOUVER, VICTORIA, NELSON.**

A. ALLAN, Pres.

F. SCHOLLES, Man. Director.

I. O. GRAVEL, Sec.-Treas.

# THE CANADIAN RUBBER CO.

Of MONTREAL, TORONTO and WINNIPEG.

CAPITAL, - - \$2,000,000.

MANUFACTURERS OF

First Quality Rubber Boots and Shoes, Superior Quality Rubber Beltings, including the Forsyth Patent (Boston Belting Co.) Seamless Rubber Belting, for which we are Sole Agents and Manufacturers in Canada.



We hold the Patent and Sole Right to Manufacture in Canada

## The Patent Process Seamless Tube Hose.

We make all our Hose by this Process.

ASK THE MERCHANT YOU DEAL WITH FOR IT AND TAKE NO OTHER.  
**RUBBER PACKINGS, VALVES, GASKETS, ETC.**

HEAD OFFICE AND FACTORY:

...MONTREAL.

J. J. MCGILL, GEN. MANAGER.

WESTERN BRANCH:

Corner Front and Yonge Sts.,

TORONTO.

J. H. WALKER, MANAGER.

## MOSES PARKER

Iron  
Founder

19 to 29 Dalhousie St.  
Montreal

Estimates Furnished.

All Orders will receive Personal Attention.

## MILLER BROS. & TOMS

(ESTABLISHED 1869.)

Machinists,  
Millwrights and  
Engineers,

STANDARD ELEVATORS

FOR ALL PURPOSES.

Derricks, Hand and Steam Power,  
Hoisting Engines,  
Foundry and Machine Shop Cranes,

Shafting, Pulleys,  
Hangers, Gearing, etc.

CORRESPONDENCE SOLICITED.

122 KING STREET,

Montreal.

# INGERSOLL ROCK DRILL CO. OF CANADA,

**Mining**  
And . . .  
**Contractors'**  
**Plant.**



164 St. James Street,

**Montreal.**

ESTABLISHED 1863.

A. CLISH, Manager.

D. McDONALD, Supt.

S. R. TUPPER, Sec.-Treas.

• • •  
**TRURO FOUNDRY AND  
MACHINE CO.**

**Engineers,  
Boilermakers  
And . . .  
Founders.**



MANUFACTURERS OF

**STOVES,  
IRON BRIDGES,**

Ship, Mill and General Castings  
in Iron and Brass.

ROTARY SAW MILLS,  
SHINGLE AND LATH MACHINES,  
GANG EDGES, ETC.

## Gold Mining Machinery,

WITH LATEST IMPROVEMENTS A SPECIALTY,

 **TRURO, N. S.**

— FOR —

**Railway** ••

AND **Contractors'**

•• **Supplies,**

SEND TO . . .

## G. & J. Brown Mfg. Co.

LIMITED,

BELLEVILLE, Ont.

BRIDGE BUILDERS, ENGINEERS, BOILER MAKERS,

MACHINISTS AND FOUNDRYMEN.

MANUFACTURERS OF . . .

Frogs, Diamond Crossings, Switches, Hand Cars,  
Lorries, Velocipede Cars, Jim Crows, Track  
Drills, Semaphores, Rail Cars, Double and  
Single Drum Hoists, Etc. . . . .

# PARMENTER & BULLOCH,

MANUFACTURERS OF

- Iron, Steel, Copper and Brass
- Rivets and Burs, Wire Nails,
- Felloe Plates, Counter Sunk,
- Wagon - box and Hinge Nails,
- Carpenters' Braces, the Patent
- Tubular and Patent Bifurcated
- or Slotted Rivets, Shoe Lacing
- Studs, Shoe and Overshoe Buck-
- les, etc. . . . .

HEAD OFFICE AND WORKS, - GANANOQUE.

BRANCH WAREHOUSES.

32 & 34 St. Dizier St.  
MONTREAL.

18 Front Street,  
TORONTO.

## R. McDougall & Co.

GALT, ONT.

MANUFACTURERS OF

### HOT WATER BOILERS,

For Heating Purposes.

### PUMPS, IRON BRASS . . . . .

For all Specifications.

### WIND-MILLS, . . . . .

For Pumping.

Our Catalogue is yours for the asking.

THE STARR MANUFACTURING CO., LTD.  
DARTMOUTH, - NOVA SCOTIA.

### Skates.

THE GENUINE ACME.  
Hockey, Racing,  
Special Skates for Figure  
Skating.

*Our Catalogue tells all about them*

### Bolts

Of every description.

### Nuts.

- Square and Hexagon.  
Whitworth and Manufac-  
urers' Standards.

### Lag Screws

From Refined Iron.

### Washers

Punched true to gauge  
perfectly flat and with  
hole in centre.

### Bolt Ends.

With Square or Hexagon  
Nuts.

### Rivets

Steel or Iron, for Boiler-  
makers and Bridge Build-  
ers. Any pattern.

### Wrought Spikes.

Railway and Ships, Black  
or Galvanized. Special  
Shapes made to pattern  
or design furnished.

### Electroplating.

Gold, Silver and Nickel, the  
highest quality only.

### Machinists.

Difficult Machine Work,  
Sheet Metal Punching,  
Forgings, etc., etc.

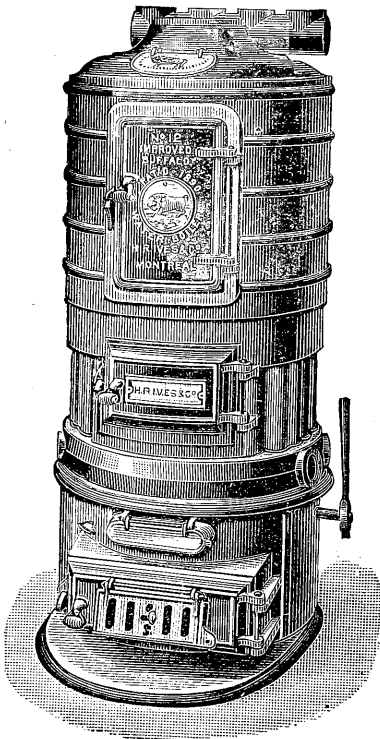

... THE ...  
**BUFFALO**  
 ... HOT WATER HEATER ...

Adopted by the Dominion Government.  
 In use at Rideau Hall, Ottawa.  
 Custom House, Moncton, N.B.  
 And in Banks, Churches, Convents  
 And Hundreds of Dwellings. . . .

THIS Boiler has now been in use for four years, a period of trial sufficient to demonstrate all of its good points as well as its defects. We claim to have overcome any of the latter, as they have developed, and added many useful improvements, so that at the present time we confidently recommend it as the

**BEST AND MOST ECONOMICAL HEATER IN THE MARKET.**

One of its best points is the ease with which it is managed. It does not require an Engineer to run it. An intelligent domestic can manage it.

PLEASE SEND  
 FOR  
 CATALOGUE.

**H. R. IVES & CO.**

QUEEN STREET, MONTREAL.

**Engines.**

SIMPLE  
 COMPOUND  
 MARINE  
 CORLISS

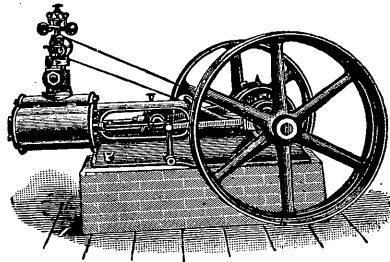

**Boilers...**

STATIONARY  
 MARINE  
 LOCOMOTIVE  
 ANY STYLE

**GOLD MINING MACHINERY**

OF THE VERY LATEST MODERN TYPE.

**I. MATHESON & CO., Engineers,**  
 NEW GLASGOW, NOVA SCOTIA.

ANDREW ALLAN, J. O. GRAVEL, JOHN BAILLIE,  
 President. Vice-President. Man.-Director.

THE . . .  
**Dominion Oil-Cloth Co.**

MANUFACTURERS OF ALL KINDS OF

FLOOR OIL-CLOTH,  
 TABLE OIL-CLOTH,  
 STAIR OIL-CLOTH,  
 CARRIAGE OIL-CLOTH,  
 ENAMELLED OIL-CLOTH,  
 SHELF OIL-CLOTH.



&c., &c.: &c.

THE TRADE ONLY SUPPLIED.

ALSO SOLE MANUFACTURERS OF THE CELEBRATED

**"D. O. C."** WHITE LEAD,  
 PAINT AND PUTTY.

OFFICE AND WORKS:

Cor. Parthenais and St. Catherine Streets,

BRANCH OFFICE:

COR. FRONT & YONGE STS.,  
 TORONTO.

**MONTREAL.**

Telephone 2489.

**DOMINION**  
**COPPER AND**  
**BRASS WORKS,**

COULTER & CAMPBELL, Props.

MANUFACTURERS OF

DISTILLERS', BREWERS' AND CONFECTIONERS'

**Copper** and  
**Brass Work,**

Marine, Dyers and Varnish, Copper and  
 Brass Work to Order, and all kinds of  
 Metal Spinning.

WE ALSO MANUFACTURE

Copper Range Boilers, Baths, Copper Tea  
 Kettles, Wash Boilers, Cuspidors, Lawn  
 Sprinklers, in fact if you want anything in  
 Copper or Brass, it will pay you to order  
 direct from us.

BRASS RAILING A SPECIALTY.

All orders and applications for Tenders  
 receive personal and prompt attention.

SATISFACTION GUARANTEED.

155 to 157 George Street  
 and 2 to 12 Britain Street,

**TORONTO, ONT.**

**PATTERSON & HEWARD**

. . . MANUFACTURERS OF . . .

Brass Stamps,  
 Memorial Brasses  
 Brass Signs,  
 Etc.,

MACHINE NAME PLATES.

40 WELLINGTON ST. W.

**TORONTO, Ont.**

**WM. HOWE,**

MANUFACTURER OF

**White Lead, Zinc White**  
 ETC., ETC.,

READY MIXED PAINTS,  
 DRY COLORS,  
 PURE COLORS IN OIL,  
 SUPERFINE COACH COLORS,  
 FLAT BRICK PAINTS,  
 OILS, TURPENTINE, VARNISHES  
 BRUSHES, &c., &c.,

**Window and Photo Glass**  
 PLATE GLASS,

WHOLESALE AND RETAIL.

HOWE BLOCK,

**OTTAWA, ONT.**

ST. CATHARINES, ONT., CAN.

BUFFALO, N.Y.

COLUMBUS, OHIO.

# McKinnon Dash & Hardware Co. of St. Catharines, Ltd.

MANUFACTURERS OF



ALL KINDS

## Buggy, Carriage and Phaeton Dashes and Fenders.....

A complete line of Carriage Trimmings, Tin Prop Nuts, and Rivets, Buckle Loops, Curtain Lights, Solid Leather Washers, Metal Rim Washers, Valances, and the **All Steel Whip Socket.**

ALSO

Complete line of Suspender Buckles and Trimmings, Wire, Tin and cast-off Buckles, Grip Backs, Fronts, square, half-round and triangle Rings

WRITE FOR...

SAMPLES AND  
CATALOGUES.

St. Catharines, Ontario, Can.

## Tisdale's Iron Sanitary Stable Fittings.

BEFORE FITTING UP YOUR STABLE,  
WRITE FOR OUR ILLUSTRATED  
CATALOGUE OF

## SANITARY IRON STABLE... FITTINGS.

We Manufacture a Complete Line.  
"The Best is always the Cheapest."

## THE TISDALE IRON STABLE FITTINGS Co., LTD.

6 ADELAIDE STREET EAST,  
TORONTO...

## THE WOMAN THAT DID

Not advise her Husband or Sweet  
heart to buy only a BICYCLE or  
BUGGY trade-marked

## "FRONTENAC"

Was not posted. Even our com-  
petitors sorrowfully admit that they  
are "FINISHED TO PLEASE"—  
those who use them know they are  
"BUILT TO WEAR."

KINGSTON VEHICLE CO.,  
KINGSTON, Ontario, Canada.

MANUFACTURERS FOR THE TRADE HIGH GRADE

## BICYCLES AND BUGGIES



**ST. CATHARINES  
BOX AND BASKET CO.,**  
(LIMITED.)  
ST. CATHARINES, Ont.

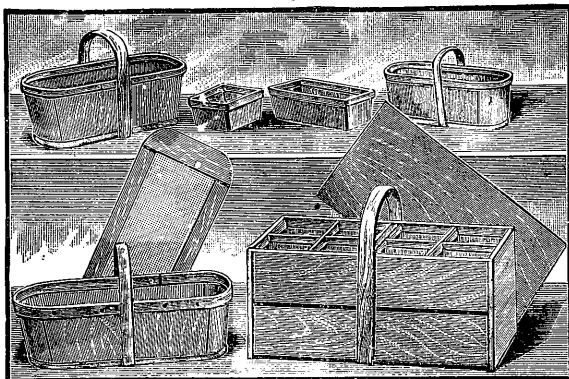

MANUFACTURERS OF  
**Baskets, Crates, etc.,  
Cheese Box Hoops.**

HEADQUARTERS FOR

**BERRY BOXES.**

**D. DOWELL,** 624 St. Paul Street,  
(Near Hay Market.)

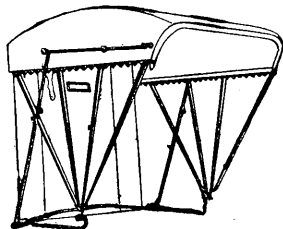

Fancy Leather and Ribbon.

MONTREAL,  
MANUFACTURERS OF ..  
Carriage Tops  
OF ALL KINDS.  
Carriage Trimmings  
OF ALL KINDS.  
Express Tops and all  
kinds of Cushions.  
Saddle Houseings,  
Breast Plate Houseings.  
Fronts and Rosettes.

ALL KINDS OF REPAIRS.

**SIMPSON, HALL, MILLER & CO.**

.. MANUFACTURERS OF .

STERLING SILVER

**Electro = Plated Ware,**

AND ALSO PROPRIETORS AND MANUFACTURERS OF THE

**Celebrated WM. ROGERS' Knives,  
Forks and Spoons.**

• • •  
HEAD OFFICE & FACTORIES: WALLINGFORD, CONN.  
CANADA BRANCH: MONTREAL.

A. J. WHIMBEY, Manager.

**ALMONTE ROLLER MILLS.**

TRY OUR

**"Strong Bakers" and "Family"**

**.. FLOUR ..**

Shipping Mixed Cars a specialty.  
We handle all kinds of Coarse Grain.  
Write for prices.

J. W. WYLIE, Prop.

**WOLTZ & McMAHON,**

.. MANUFACTURERS OF ..

**PICTURE & ROOM MOULDINGS**

.. AND DEALERS IN ..

**PICTURES AND  
PICTURE FRAMES,**

130 Richmond St. West,

**TORONTO, Ont.**

THE

**C. TURNBULL CO.**

OF GALT, (LIMITED.)

MANUFACTURERS OF

**FULL - - FASHIONED Underclothing**

*Hosiery and Knitting Yarns,*

*Men's Shirts and Drawers,*

*Ladies' Vests,*

*Ladies' and Children's Combination Suits,*

*Boys' and Girls' Vests and Drawers,*

*Jerseys, Sweaters, Knickers,*

*Plain, Striped, or Colors.*

THE **EUREKA** Refrigerator Co. of Toronto,  
W. HOOEY, Mgr.

OFFICE & WAREHOUSES: 54 & 56 NOBLE ST.,  
**Toronto, Ont.**

MANUFACTURERS OF  
**Cold Storage Houses**  
... AND ...  
**Refrigerators**  
OF ALL SIZES, FOR

Butchers,  
Grocers,  
Hotels,  
Restaurant  
and . . .  
Domestic  
Use.

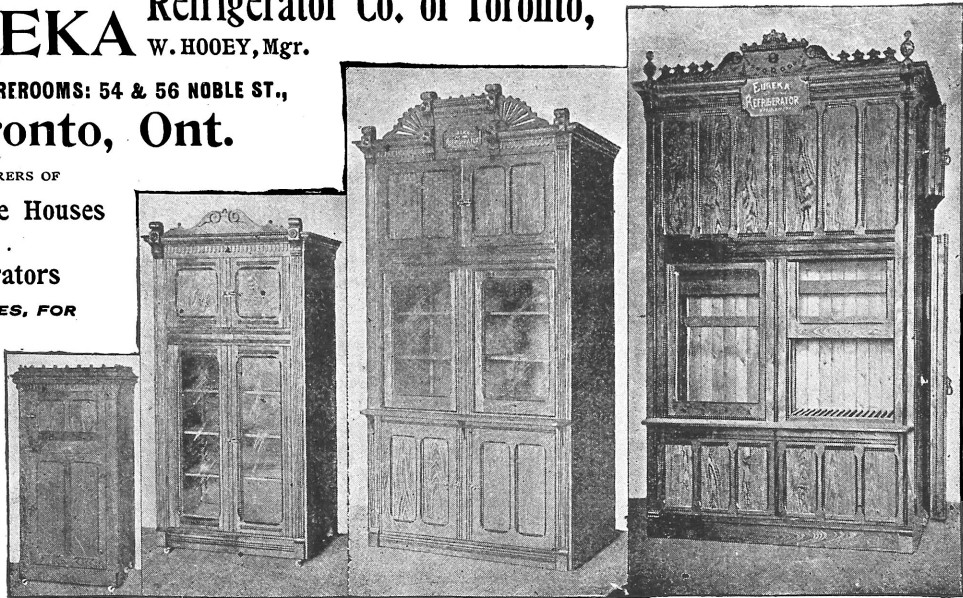

**DOMESTIC    DOMESTIC & GROCER.    GROCERS    BUTCHERS.**  
*Refrigerators of all descriptions built to order, also COLD STORAGE.*

THE EUREKA REFRIGERATOR CO. OF TORONTO, Ont., Can.

SEND FOR CATALOGUE AND PRICE LIST.

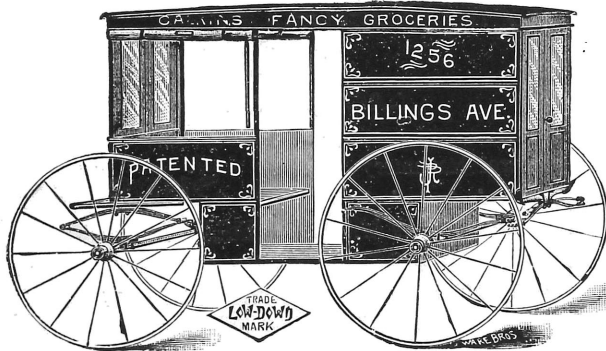

THE FAMOUS  
**Low-Down Milk Wagons**

Bread, Meat and Grocery Wagons,  
*Are in keeping with the PROGRESSIVE  
SPIRIT of the AGE.*  
**EASY TO LOAD.    EASY TO GET IN AND OUT.**  
**CONVENIENT FOR CUSTOMERS.**  
All built in our Patent Short Turn Gear.    Sell on Sight.  
Special Prices to the Trade on application.

**BUILT ONLY BY**  
**THE ASHLEY CARRIAGE WORKS,**  
**BELLEVILLE, ONT.,**

**DOUGLAS BROS.,**  
Roofing and Sheet Metal Work,  
Slate, Tile, Felt,  
Gravel and Metal Roofers,  
Metallic Ceilings, Metallic Shingles, Metallic Sky-  
lights, Corrugated Iron, Patent Wood Glass,  
SOLE AGENTS FOR THE CELEBRATED  
**BLACKMAN VENTILATING WHEEL.**  
124 ADELAIDE STREET WEST,  
**TORONTO, Ont.**

TELEPHONE 2672.    J. M. DOWNER.  
**The Downer**  
• **Pattern Works,**  
Patterns and Models made for  
Engines, Pumps and Furnaces,  
*Agricultural and Architectural Work and Machines of  
Every Description.*  
ESTIMATES FURNISHED.    DESIGNS CAREFULLY PREPARED.  
**89 WELLINGTON STREET WEST.**  
**TORONTO, Ont.**

**SPECIAL NOTICE TO USERS OF**

**Wood-working Machinery**

**THROUGHOUT THE DOMINION.**

**J. BALLANTINE & CO...**

 **W**E beg to call your attention to our latest improved Woodworking Machinery . The Machines are constructed from the best material and are built by the most skilled machinists of long experience, thus ensuring your unbounded satisfaction.

We respectfully call your attention to our **CUT GEAR** for Woodworking Machinery. **CUT GEARS** have no equal for the nice even and smooth feed which are obtained by the use of them.

We are the **ONLY FIRM** in the Dominion who have adopted the use of Cut Gears for Wood-working Machinery.

Our Foundry is one of the largest and best equipped shops (devoted to this special line) in the Dominion, covering 20,000 square feet.

Write for Descriptive Sheet and price of any machinery you may require

N.B.—Get our prices before buying elsewhere. **IT WILL PAY YOU.**

Yours Respectfully,

**J. BALLANTINE & CO.,**

**PRESTON, ONT., CANADA.**

**VIDAL, FILS**  
**& CO.,**

...QUEBEC, P.Q.

Manufacturers of 

Rotary Saw Mills,  
Log Mills, Shingle Mills and  
 Re-sawing Machines,  
Shaftings, Hangers and  
Cast Pulley Hubs.



**ON HAND** 

All Sorts of Machinery.

**VICTORIA**  
**FOUNDRY,**  
**LACHUTE, P.Q.**



General Machinery  
and . . . . . **Mill Supplies,**

**GRIST, SAW AND PAPER MILL MACHINERY,**  
**CHEESE FACTORY OUTFITS,**  
**PUMPS AND PUMPING MACHINERY - A SPECIALTY.**  
**McOUAT & McRAE.**

**W, S. MAYO,**  
...MACHINERY BROKER...

DEALER IN 



**NEW AND SECOND HAND**  
**MACHINERY,**

AND MANUFACTURER OF

**POWER FEED Box Machinery**

**OTTAWA, ONT., CANADA.** 



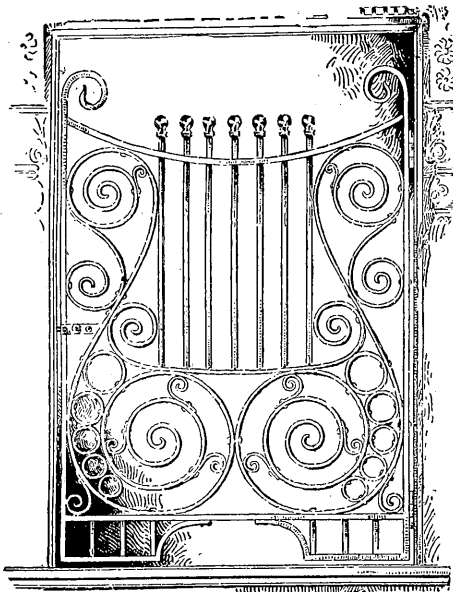

# Art Metal Work



Architectural Iron Work.  
Wire Work and Wire Goods.

## Electro-Plating

 IN ANY FINISH.

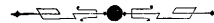

When you want anything made  
... in any metal, write ...

The DENNIS WIRE & IRON WORKS,

CATALOGUES ON APPLICATION.

LONDON, CANADA.

THE

# Woodyatt Lawn Mower.

PATENTED IN

England, May 15th, 1893.

Canada, May 29th, 1893.

United States, Dec. 12th, 1893.

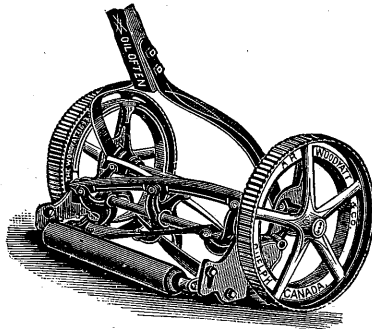

CANNOT BE SURPASSED  
FOR 

SMOOTH WORK,  
LIGHT RUNNING  
AND DURABILITY.

MANUFACTURED BY

A. R. WOODYATT & Co., = GUELPH, Can.

# THE "LUNKEN" GATE VALVE

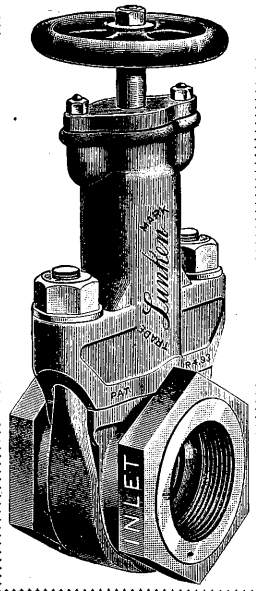

Iron Body screwed 2" to 12" for 200 lbs. working pressure. Heavy,

With Balanced Disc and Renewable Seat.

**SOMETHING NEW. SOMETHING GOOD,  
A LONG FELT WANT.**

## A Valve

whose Seat and Disc are renewable without disconnecting pipes.  
with balanced Disc, frictionless and operating easily under high pressure.  
although with straightway, is more compact than a Globe Valve.  
provided with rising Spindle, thus indicating whether it is open or shut.  
such as all users have thought a necessity.  
you will use continually after trying the first one.

Write for Prices also on "Weber" Patent Straightway Valves and "Kerr's" Quick Opening Radiator Valves.

MANUFACTURED ONLY BY

**The Kerr Engine Company, Ltd.,**

**WALKERVILLE, ONT.**

## The Ellis Furniture Co.

... MANUFACTURERS OF ...

**Parlor Suites, Floor Rockers,  
Easy Chairs, Barber Chairs,  
Lounges, Lodge and  
Cobbler Rockers, Church Chairs.**

... IMPORTERS AND JOBBERS OF ...

**Upholsterers' Goods and Supplies.**

**Mohair and Silk Plushes,  
Brocatelles and Silk Tapestries,  
Cotton Tapestries, Jutes,  
Curled Hair, Moss Tow,  
Silk Gimp, Cords and Buttons,**

... MANUFACTURERS OF ...

**Mattresses and Furniture Springs.**

**INGERSOLL, Ont., Canada.**

## JAMES PENDER & CO.

... MANUFACTURERS OF ... (Limited.)

Bright . . .  
Tinman's . . .  
Annealed, and  
Oiled and . . .  
Annealed . . .

**Wire** "BULL DOG" STEEL  
WIRE NAILS,  
FOR ALL PURPOSES.

POINTED AND FINISHED

**SWEDES IRON HORSE NAILS,**

COMMON AND CLINGING POINT BRASS AND STEEL

**Shoe Rivets.**

BEST ANNEALED

STEEL WIRE FOR HAY BALE TIES,  
In Bundles,  
or Straightened and Cut to Length.

• • •

OFFICE AND WORKS:  
CHARLOTTE STREET EXTENSION.



**ST. JOHN, N.B.**

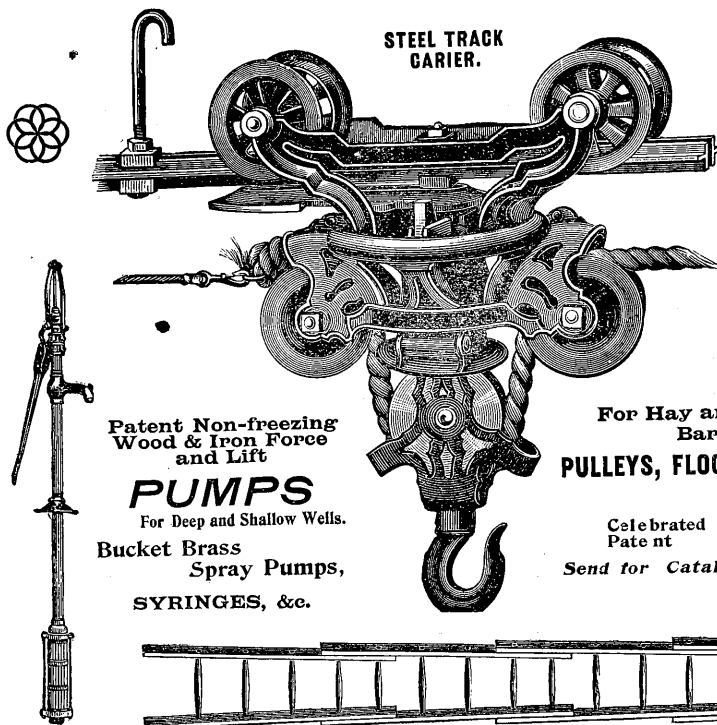

STEEL TRACK  
CARRIER.

Patent Non-freezing  
Wood & Iron Force  
and Lift

**PUMPS**

For Deep and Shallow Wells.  
Bucket Brass  
Spray Pumps,  
SYRINGES, &c.

**LAING,  
RITCHIE & CO.**

MANUFACTURERS OF  
STEEL AND MALLEABLE  
**Horse Forks & Carriers**

FOR WOOD AND STEEL TRACK.

Long & Short Rope  
and Centre Trip **SLINGS**

For Hay and Sheaves of all kinds, Loose  
Barley, Pease, Beans, &c., &c.

**PULLEYS, FLOOR HOOKS, HANGER HOOKS,  
. . . RAFTER BRACKETS, ETC., ETC.**

Celebrated  
Patent **EXTENSION LADDERS.**

Send for Catalogue and Price List.

**ESSEX, ONT., CAN.**

PETER HAMILTON.

R. D. HAMILTON.

**PETER HAMILTON M'FG Co.**

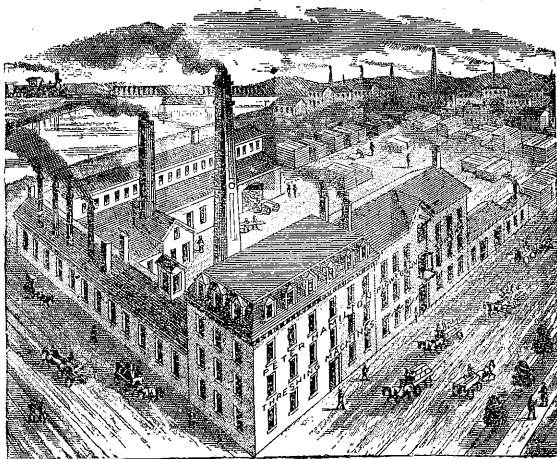

MANUFACTURERS OF ALL KINDS OF

**HARVESTING • MACHINERY  
AND AGRICULTURAL IMPLEMENTS.**

Peterborough, Ont., Canada.

Send for our Illustrated Catalogue.

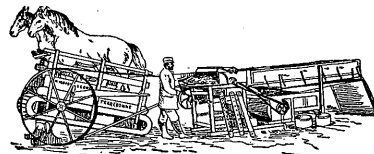

OUR THRESHING MACHINE.

WE MANUFACTURE EVERY COMPLETE LINE OF  
LABOR  
SAVING **FARM MACHINES.**

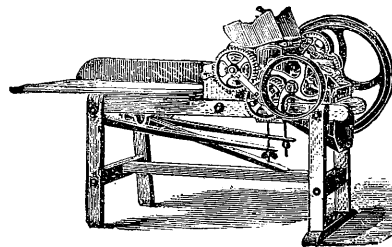

OUR FEED CUTTER.

MANUFACTURERS OF

**RAKES, MOWERS, REAPERS, BINDERS,  
POTATO MACHINES, FLAX BREAKER,  
ROAD MACHINE, CIRCULAR SAWS, &c., &c., &c.**

**MATTHEW MOODY & SONS,  
TERREBONNE, Que.**

# The Canadian Office & School Furniture Co.

(Successors to W. STAHLSCHMIDT & Co.)

PRESTON, ONTARIO.

**MANUFACTURERS OF OFFICE, SCHOOL, CHURCH AND LODGE FURNITURE.**

BANK, DRUG STORE AND COURT HOUSE FITTINGS

*A SPECIALTY.*

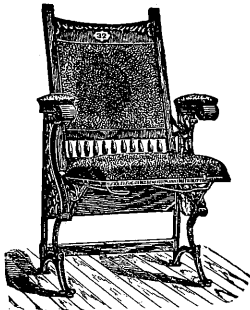

No. 53. OPERA CHAIR.

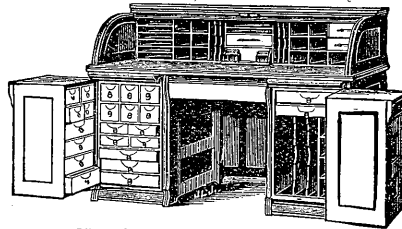

No. 56. LATEST OFFICE DESK.

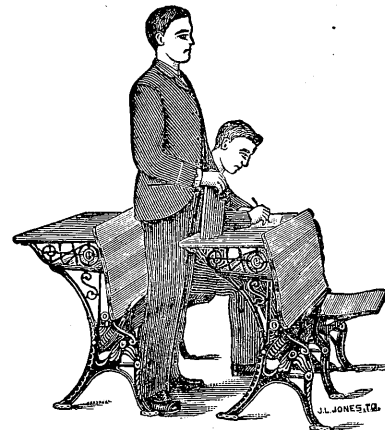

THE "PERFECT AUTOMATIC" SCHOOL DESK.  
*Awarded Gold Medal at Jamaica Exhibition.*

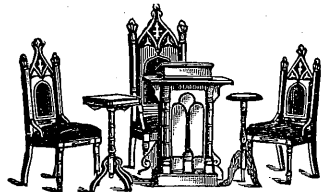

No. 5. PULPIT SET.

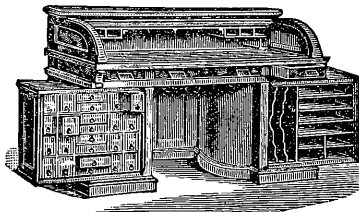

No. 51. ROTARY OFFICE DESK.

Send for Catalogues and Price Lists.

**THE JOSEPH HALL MACHINE WORKS.**

## ROBERT WOON & CO.

...PROPRIETORS...

(SUCCESSORS TO THE JOSEPH HALL MANUF'G CO.)

MANUFACTURERS OF

### AGRICULTURAL and GENERAL MACHINERY,

Lffel Double Turbine Water Wheels,  
Leather Splitters, Knife Grinders,  
Glassing and Pebbling Jacks,  
Slush Wheels, Shafting, Hangers, Pulleys,  
Couplings, Champion Mowers,  
Improved Clover Mills, Hall Threshers,  
Horse Powers, Band Jacks, etc., etc.

*Special attention given to the furnishing of REPAIRS for all  
MACHINES and MACHINERY made at the*

**JOS. HALL MACHINE WORKS, MASSON MFG. CO.  
AND DINGLE ESTATE,**

*Having bought their Patterns, Templates, Drawings, Flasks, etc.*

**OSHAWA, ONT.**

ESTABLISHED 1885

## JAS. W. PROVAN,

OSHAWA, Ont.,

### HAY CARRIERS, FORKS AND SLINGS.

*Sole Manufacturer and Patentee;*

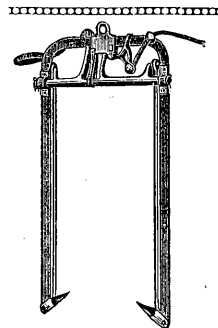

**LATEST IMPROVED**

Carrier for Iron Track  
Carrier for Wood Track  
Carrier for Angle Steel Track  
Double Harpoon Steel Fork  
Slings (End or Centre Tip)

**BEST MATERIAL AND  
WORKMANSHIP.**

*SEND FOR PRICES.*



# A. RAMSAY & SON,

MANUFACTURERS OF

Unicorn Mixed Paints,  
Unicorn White Lead,  
Unicorn Oil Stains,  
Coach & Carriage Varnish's  
Furniture Varnishes,  
Japans and Lacquers,  
Dry Colors,  
Kalsomines,  
Coach Colors in Japan,  
Colors in Oil and Water,  
Ornamental Glass,  
&c., &c., &c.



TRADE MARK.

OUR SPECIALTIES:

PLATE GLASS MIRRORS,  
GERMAN MIRRORS,  
BEVELED GLASS,  
PRINTERS' INKS,  
LITHO. INKS.

IMPORTERS OF

Window Glass,  
Enamelled Glass,  
Fancy Glass,  
Artists' Materials,  
Glaziers' Diamonds,  
Glues,  
Sponges,  
Chamois,  
Brushes,  
Painters' Tools,  
Chalks, Whittings,  
&c., &c.; &c.

OFFICE & WAREHOUSE—37-41 Recollet St.  
COLOR FACTORY—141-151 Frontenac St.  
VARNISH FACTORY—106 William St.  
STORES—16-22 Inspector St.



## Montreal, Que.

## J. H. FARR & CO.

MANUFACTURERS OF

### FINE • VARNISHES

Maple Leaf Brand of Coach Varnish,  
Peerless Furniture Varnish, Japans,  
Shellacs, - Asphaltums, - Eureka  
Armature Baking Black Japan,  
Mica Paste, Insulating Compound.

... ALSO ...

Armature & Field Insulating Compound

... AND ...

Roofing & Paving Pitch.

• • •

8 TO 16 MORSE STREET,

TORONTO, ONT.

LATEST STYLES OF

## WALL PAPERS,

MANUFACTURED BY

## WATSON, FOSTER & CO.,

Montreal,

Canada.

• • •

EVERY SIDE WALL HAS FREIZE AND  
CEILING TO MATCH.

• • •

Office & Works, - 86 to 94 Grey Nun St.

MONTREAL.

Capacity—40,000 Rolls per day

# CHURCH'S COLD WATER ALABASTINE

THE PERMANENT WALL COATING.

**JELLSTONE** { *THE NEW COLD WATER WALL COATING,*  
 Made especially for Painters' use and sold in bulk at a low price.  
 Not advertised to the general public. . . . .

**Church's Potato Bug Finish** *NO MIXING REQUIRED,  
 READY FOR USE DRY.*

**PARISTONE WALL PLASTER,  
 CALCINED AND LAND PLASTER.**

Save freight by buying from the manufacturers. Prices and freight rates quoted to all points west and north of Toronto.

The only manufacturers of Calcined Plaster in Ontario.

**THE ALABASTINE CO., Ltd., PARIS, Ont.**

## The London Brush Factory

61 to 65 Dundas Street,

LONDON, ONT.

AWARDED  
 GOLD  
 AND  
 SILVER  
 MEDALS.

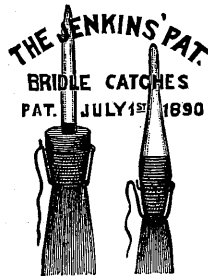

Canadian Pat. July 29, '91

PAINTERS  
 ALL  
 PREFER  
 TWINE  
 BRIDLES.

*Having secured the right to use JENKINS' PATENT BRIDLE CATCH, they will be attached to all our large Paint Brushes without extra cost.*

**THOS. B. RYAN,**

**Brush Manufacturer, LONDON, Canada.**

## Hobbs' Glass Works, LONDON, Ont.

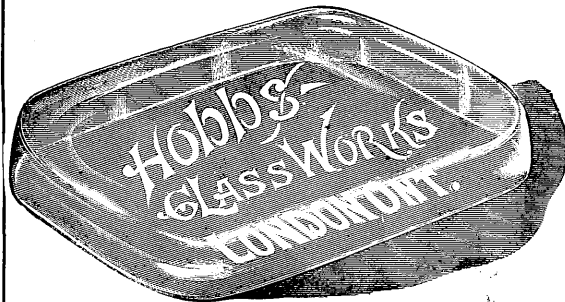

WE MANUFACTURE

Mirrors, Paper Weights,  
 Advertising Signs,  
 Brewers', and Distillers' Signs,  
 Patent Medicine Signs,  
 Sand Cut Work, Mitred Glass,  
 Church Windows,  
 Enamelled and Obscured Glass.  
 Mitred Glass.



**Wire Nails and Barbed Wire.**

**Montreal Brass Works.**

**ROBERT MITCHELL & CO.**

- - MANUFACTURERS OF - -

**Gas <sup>AND</sup> Electric Light Fixtures,**

**GAS METERS,**

**ENGINEERS', PLUMBERS',**

**GAS and STEAM FITTERS'**

**BRASS GOODS.**

Office and Show Room: 8 Bleury Street,  
MONTREAL.

Factory: ST. CUNEGONDE.

**HORSE NAILS**

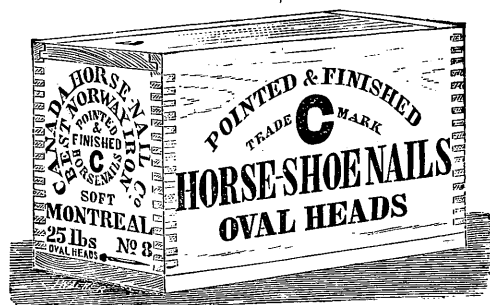

.. Canada ..

**Horse Nail Company.**

**MONTREAL.**

**CARLETON WIRE AND WIRE  
NAIL WORKS.**

Manufacturers  
of . .  
Extra Quality

**STEEL  
WIRE  
NAILS**

OF ALL DESCRIPTIONS.

J. J. GORDON, Propr.

**St. John, N.B.**

HON. A. DESJARDINS, Pres.

JOS. BARSALOU, Vice-Pres.

HUBERT DESJARDINS, Man. Dir.

N. T. GAGNON, Secretary.

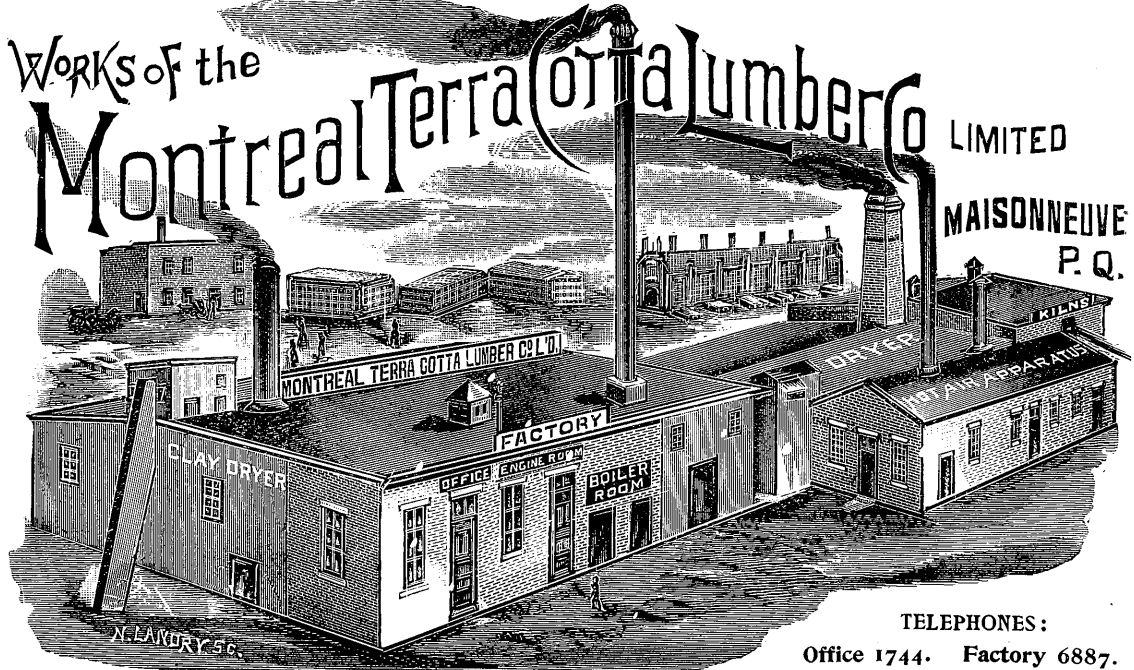

TELEPHONES:

Office 1744. Factory 6887.

Fire Proofing Tiles in all sizes and Shapes. For prices and estimates apply to  
N. T. GAGNON, 86 St. Peter St., Montreal, Can.

Red Oak, White Oak, Cottonwood, White Ash,  
Black Ash, Sycamore, Soft Maple, Elm.

**T. H. DECEW,**  
**HARDWOOD LUMBER,**

Sugar, Flour, Apple and Salt . .

• **BARREL STAVES,**

Also Charcoal and Cordwood.

MILLS AT ESSEX AND COLCHESTER. YARDS AT HARROW

**ESSEX, ONT.**

**O. V. GOULETTE,**

MANUFACTURER OF

*Tool Handles, Windmills, Croquet, Wheel  
Heads, Spinning Wheels, Buggy Bodies,  
also all kinds of turnings  
done to order.*

Send for Illustrated Catalogue.

**GANANOQUE, ONT.**



**CENTRAL BRIDGE AND**   
**ENGINEERING CO.**  
(LIMITED.)

**PETERBOROUGH, ONT.**

**Bridges** of all designs,  
RAILWAY and HIGHWAY.  
**ALL STRUCTURAL WORK IN IRON  
AND STEEL.**

**Power Hammers.**  
THE "OPTIMATES." LAW'S PATENT.  
The most perfect Power Hammer made.

**Surface Cattle Guards.**  
LAW'S PATENT.

**Safety Switches.**  
Sole manufacturers in Canada of the  
**RAMAPO PATENT SAFETY SWITCH STANDS.**

**Flexible Joints for Water Works.**  
LAW'S PATENT.

Any Diameter, 2 feet and upwards.  
Used by Toronto and Rochester, N.Y. in Water Works  
Conduits.

THE

# A. Gravel Lumber Co.

ETCHEMIN, P.Q. LIMITED.

WHOLESALE DEALERS IN

## Canada Lumber.

Manufacturers of Portable Houses, Doors, Sashes,  
Blinds, Mouldings, Packing Cases, Clothboards, etc.

DRY KILNS AND STEAM MILLS FOR DRESSING.

SPECIALTIES

Spruce Lumber and Box Shooks for Export,

SHIPMENTS BY RAIL AND WATER.

### BEAMSVILLE PRESSED BRICK CO.

MANUFACTURERS OF

HIGH GRADE

### Pressed Brick

OF ALL COLORS.

... ALSO ...

FLOORING, ROOFING AND FARM DRAIN

### TILE.

We are also the largest manufacturers in Canada of  
**Ornamented Terra Cotta**, making a specialty  
of this line.

Write us for Catalogue and information.

**BEAMSVILLE PRESSED BRICK CO.,**  
WM. TALLMAN & SON, Props. **BEAMSVILLE, ONT.**

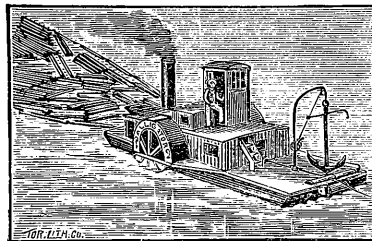

### THE ALLIGATOR STEAM WARPING TUG,

MANUFACTURED BY

**WEST & PEACHEY, - SIMCOE, ONT., CAN.**

Patented in Canada and the United States.

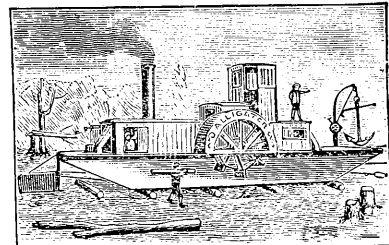

The

# PEMBROKE LUMBER CO.

JOHN BROMLEY, Manager,

MANUFACTURERS OF AND DEALERS IN

All kinds of LUMBER, LATHS, SHINGLES, Etc.

DIMENSION TIMBER A SPECIALTY.

BILLS CUT TO ORDER, EITHER SUMMER OR WINTER.

PEMBROKE, ONTARIO.

The St. Anthony Lumber Co.

LIMITED.

Of WHITNEY, Ontario,

MANUFACTURERS AND DEALERS IN



Lumber, Lath

And . . . .

Shingles,



OTTAWA OFFICE:

P. O. BOX 1036, 102 WELLINGTON ST.,

OTTAWA, ONT.

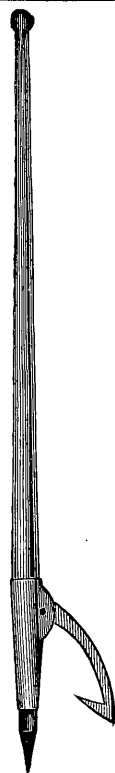

Wm. Wallace

MANUFACTURER OF

Cant Dogs,  
Timber Dogs,  
Boat Hooks,

Three Rivers,  
Que.

# ACME VENEER WORKS

ORILLIA,  
ONTARIO.

Carriage and Cutter  
Pannels,  
Cheese Box and  
Basket Material,  
Car and Furniture  
Veneer,  
Fanning Mill Material,

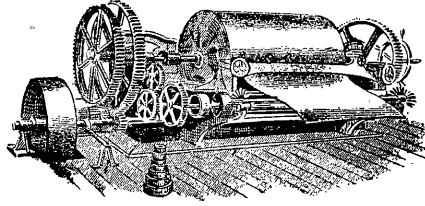

Perforated Chair  
Seats and Backs,  
Glued Veneers, for  
Mirror Backs,  
Trunk Vaneers,  
Cheese Boxes,  
Cheese Box and  
Barrel Headings.

PATENTEES AND MANUFACTURERS OF

The "LEADER" Combination Bread and Vegetable Slicer,  
and the "Acme" Wooden Oyster and ard Pail.

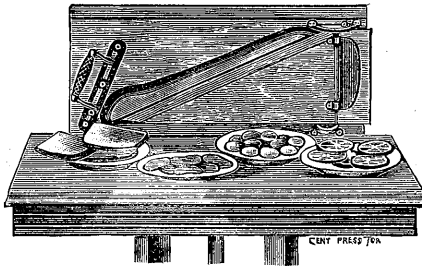

FANCY AND HEAVY VENEERS OF ALL KINDS  
ALWAYS IN STOCK.

THE  
"ACME" PAIL

IS USED FOR  
Honey, Syrup,  
Butter, Lard,  
Oysters, Berries,  
Candies, etc.

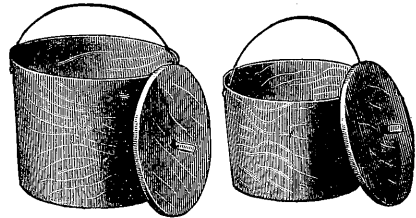

FRANK KEAN, MANAGER.



BLACKSMITHS',  
MACHINISTS'  
AND  
BOILERMAKERS'  
TOOLS.

A. B. JARDINE & CO.  
HESPELER, Ont.

## .. CANADA .. SWITCH and SPRING COMPANY.

(Successors to K. W. BLACKWELL.)

### SPRINGS

For Locomotives, Railway Cars, Electric Cars,  
Machinery and Electrical Apparatus.

### Crucible Steel Castings

Up to one ton in Weight.

### Trucks for Electric Railways.

The

### Meneely Roller Bearings

For Steam and Electric Cars.

Special

### Track and Switch Work

For Steam and Electric Railways, Frogs, Cross-  
ings, etc., Switch Stands, Track Jacks and Track  
Tools.

### Turnbuckles.

Mfg. Agents in Canada for

SAXBY & FARMER,  
Signal Engineers, LONDON, Eng.

# The Wm. Cane & Sons Mfg. Co.

Of NEWMARKET, Ont., (Ltd.)

## Manufacturers of Lumber,

Lath, Shingles, etc.  
Doors, Sash, Blinds and  
Dressed Lumber

Every description required for  
Building purposes. . . . .

## Also Wooden-ware,

Such as Pails, Lard Pails, Candy Pails,  
Spice Pails, Cocoanut Pails,  
Sap Pails, Jam and Jelly Pails,  
Wooden Pails of all sizes, Pickle Pails,  
Paint and Shipping Cans, Syrup Pails,  
Spruce Butter Tubs, Washboards,  
Clothes-pins, Snow Shovels, etc.

ALSO MANUFACTURERS OF THE

## Corrugated Steel Hoop Pails and Tubs.

For Circulars and  
Price Lists apply to

**THE WM. CANE & SONS MFG. CO., LTD.**

NEWMARKET, ONT.

## FRED. DEUTSCHMANN,

MANUFACTURER AND DEALER IN

Maple, Beech, Rock and Soft Elm, Black and White  
Ash, Butternut, Cherry, Hemlock, Bill Stuff, Pine,  
Oak, Cedar, Basswood, and Tamarac

## LUMBER.

Headings and Staves for Flour, Sugar, Salt and  
Apple Barrels.

Broom Handles, all kinds.

Shingles and Laths, and Elm Wrappings.

BEEN IN THE BUSINESS SINCE 1876.

TEESWATER, - ONT.

## The Globe File Mfg. Co.

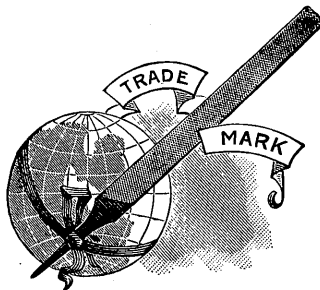

PORT HOPE,  
ONT.

**FILES**  
AND . . . .  
**RASPS**

WARRANTED.)

Write for prices.

WAREHOUSE: 17 ST. DIZIER ST., MONTREAL.

## WATERLOO

# MANUFACTURING Co.

LIMITED,

MANUFACTURERS OF

Portable Engines,

## THRESHERS

Horse Powers,

Plows,

Gang Plows,

Disc Harrows,

Seufflers,

Hay Loaders,

Grain Crushers,

Straw and Ensilage Cutters,

Root Cutters and Pulpers,

**BOILERS BUILT TO ORDER.**

HEAD OFFICE AND WORKS:

BRANCH WORKS:

**WATERLOO, ONT.**

**ELMIRA, ONT.**



# THE PETERBOROUGH LOCK MFG. CO.

PETERBOROUGH, ONT., CANADA.

MANUFACTURERS  
.. OF ..

ALL KINDS OF HOUSE and CAR LOCKS, RIM and MORTISE, PLAIN and ORNAMENTAL BRONZE and IRON.

ALL KINDS OF DOOR KNOBS, PORCELAIN, JET, MINERAL, IRON, Nickel and Bronze PLATED, REAL BRONZE, PLAIN and ORNAMENTAL.

BUILDERS' HARDWARE—comprising SASH LOCKS and SASH LIFTS, CHAIN FOOT and FLUSH BOLTS, SHELF BRACKETS, DRAWER PULLS, PUSH PLATES, BUTTS, ROTARY DOOR BELLS, BELL LEVERS & PULLS, STORE DOOR SETTS, CHANDELIER HOOKS, BIRD CAGE HOOKS, LETTER BOX PLATES, CUPBOARD CATCHES, CUPBOARD BUTTONS, REFRIGERATOR LOCKS and CATCHES, SHUTTER KNOBS, SHUTTER BARS, SASH PULLEYS, DOOR PULLS, HAT and COAT HOOKS, Etc., Etc.

*Fine Bronze Pullman and Street Car TRIMMINGS.*

*The Pullman Patent SASH BALANCES. . . . .*

*The Clarke Patent PARLOR DOOR HANGER. . .*



WRITE FOR  
CATALOGUE.

Our Goods are acknowledged to be the best of their kind in Canada.

## W. C. Edwards & Co.

(LIMITED)

.... MANUFACTURERS OF ....

Dimension Timber, Sawn and Dressed Lumber,  
Shingles, Lath, Pickets, . . . . .

Window Sash, Doors, Blinds, Mouldings, . . .

House Finish of all Descriptions, . . . . .

Kiln Dried Hardwood Flooring, . . . . .

Boxes and Box Shooks. . . . .

WOODWORK OF ALL KINDS MADE TO ORDER,

 OTTAWA, Ont.

# KERR & MORGAN,



## Machinists, Millwrights and Engineers . . . . .

### ELEVATORS PASSENGER and FREIGHT, and all Elevator Repairs.

(Estimates and Prices given on application.)

HAND AND STEAM POWER DERRICKS.

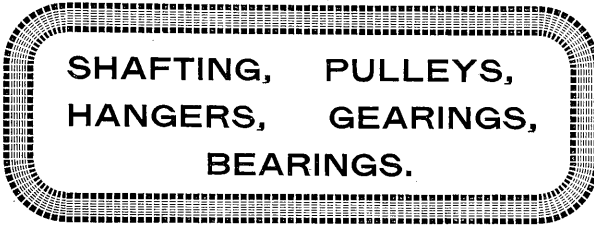

GENERAL MACHINE WORK

HOISTING ENGINES, FOUNDRY and MACHINE SHOP CRANES.

7½ Chenneville Street,

**MONTREAL.**

BUY

## THE BRANTFORD BICYCLE

IT IS RELIABLE.

All . . . Racing Men Prefer Them.

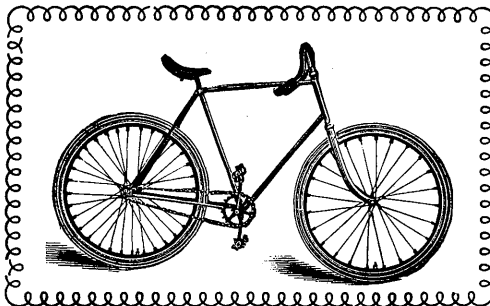

They have Standard . . . Value.

.. MANUFACTURED BY ..

DEPOTS:  
99 YOUNG ST., TORONTO.  
2410 ST. CATHERINE ST. MONTREAL.

## THE GOULD BICYCLE CO. (LIMITED)

BRANTFORD, Ont

**THE PAINT COMPANY OF CANADA.** ●●

Capacity nearly equal to all the other Paint Houses combined.

**The Canada Paint Co., Ltd,**

MANUFACTURERS OF FINE COLORS, STAINS, VARNISHES AND PAINTS.

The only "First Hands" in Canada for LEVIGATED MINERAL COLORS.

PROPRIETORS OF THE LEADING BRANDS OF

Vermillions, Window Blind Greens, Oil Wood Stains, Mixed Colors and Paints, White Leads.

MANUFACTURERS OF

Decorators' and Painters' Materials, Paper Stainers' Colors, Wall Paper Colors, Lithographers' Colors and Varnishes, Artists' Tube Colors, Carriage Builders' Primers, Fillers, Fine Colors, Varnishes, Painters' Triple Strength Tinting Colors.

OWNERS OF

Quebec Paint Lands, Graphite Mines.

AND MANUFACTURERS OF

Canadian Magnetic Iron Oxides, Indian and Venetian Reds, all shades, Diamond Graphite Paints and Specialties.

**THE CANADA PAINT CO., Ltd., 572 William St., MONTREAL.**

FACTORIES AT MONTREAL, TORONTO, AND VICTORIA, B.C.

**N. T. LYON,  
STAINED GLASS.**

141 & 143 CHURCH ST..

*Toronto, Ont.*

**McARTHUR, CORNEILLE & Co.,**

IMPORTERS AND MANUFACTURERS OF

**OILS, VARNISHES,  
PAINTS, GLUES,**

Window Glass, Chemicals, Dye Stuffs, Tanning Extracts, etc.

310 to 316 ST. PAUL AND 147 to 151 COMMISSIONERS STS.

**MONTREAL.**

**Dominion  
Glass Works,**

MANUFACTURERS OF

Glassware,	Glass Lamp Bases,
Druggists' Jars,	Lamp Chimneys,
Bottles,	Fruit Jars,
Lenses,	Lamp Founts,
Blown Glass	" Shades,
Bent Glass,	Cut Glassware,
Glass Dishes,	Table " "
" Domes,	Flint " "
" Funnels,	Pressed " "
" Inkstands,	Chemists' " "
" Insulators,	Jelly Glasses,
" Jars,	Water Gauge Tubes,
" Lamps,	Glass Oil Cups,
" Moulds,	" Stand Lamps,
" Pots,	Electric Globes,
" Rods,	Glass Casters,
" Scoops,	" Novelties
" Syringes,	of all kinds.

**LEAD GLASS CHIMNEYS OF ALL KINDS.**

**MONTREAL, Que.**

# Henry Atkinson,



— *ETCHEMIN, QUEBEC.*

*PINE AND SPRUCE*

# LUMBER,



— *LATHS and SHINGLES.*



*MILLS AT . . . .*

*ETCHEMIN, SCOTT JUNCTION and ST. RAYMOND, Que.*

# JOHN STEWART,

CONTRACTOR AND MANUFACTURER.

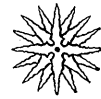
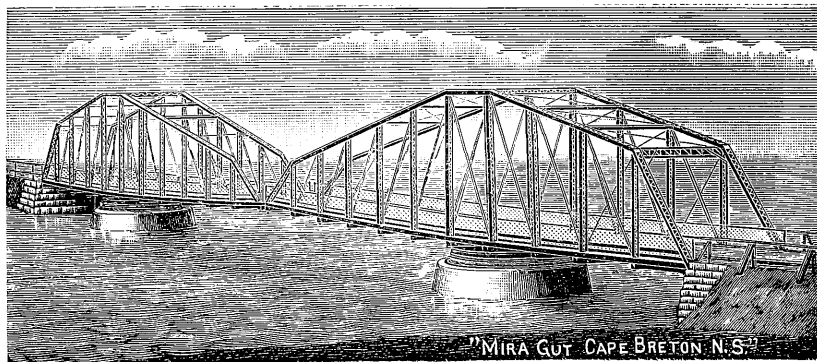

*Iron and Steel Bridges, Viaducts, Frames, Roofs, &c.*  
*Railway Switch Fittings, Railway Track Jacks,*  
*. . . . Machine Work and Forging.*

WORKS: —  
 SOUTH OF I.C.R. DEPOT.

**NEW GLASGOW, N.S.**

# H. M. PRICE & CO.

## QUEBEC, P.Q.

DEALERS IN

# — Lumber —

PULPWOOD, RAILWAY TIES, BARK, ETC.

*Lands and Timber Limits for Sale.*

SAW MILLS AT:

ST. TITE, County of Champlain, P.Q.

Price's Siding, on Tring Branch of Quebec Central Ry.

**JAS. PLAYFAIR & CO.**

MANUFACTURERS OF

**LUMBER, LATH, SHINGLES, &c.**

CONTRACTORS FOR

RAILWAY SUPPLIES.

OFFICE AND MILL, **MIDLAND, ONT.**

**JAS. PLAYFAIR & CO.**

COLLINGWOOD, ONT.

**SHIP CHANDLERS**

AND IMPORTERS OF

**GENERAL HARDWARE,**

**PAINTS, OILS, GLASS, ETC.**

WHOLESALE DEALERS IN

*Gilling Nets, Twine, Seines and Fishermen's  
Supplies.*

BELL TELEPHONE 258.

**JOHN AULD**

PROPRIETOR

**CANADIAN CORK CUTTING CO.**

(BY PATENT MACHINERY)

OFFICE AND FACTORY:

642 Lagachetiere, cor. Chenneville St.,

**MONTREAL.**

Every description of Corks on hand and cut to order ;  
also Cork-Wood and Cork Life Preservers. All  
sizes of Hard and Soft Wood Taps, Bungs, Spiles,  
Caps, Bottling Wire and Wax, Cork Driving and  
Capping Machines, Capsules, &c.

Cane Bottle Baskets, Tin-foil.

# ALEX. McARTHUR & CO.

— MANUFACTURERS OF —

## Wrapping Papers, Building Felts, &c.

Tarred Felt,  
Tarred Sheathing,  
Cyclone Sheathing,  
I. X. L. Building Paper,  
2 & 3 Ply Ready Roofing,  
Resin Cement,  
Coal Tar, Pitch, &c.

Manilla Papers,  
Brown “  
Blotting “  
Hanging “  
Paper Bags,  
&c., &c.

Proprietors of the JOLIETTE PAPER MILLS.  
Offices: MONTREAL.

→ Send for Samples and Prices

ESTABLISHED 1868.

INCORPORATED 1894.

## THE GEO. MATTHEWS CO., LTD.

### PACKERS AND EXPORTERS,

PROPRIETORS OF THE FAMOUS “ROSE BRAND” AND  
“CANADIAN FARMERS-FED” BRANDS  
OF CANADIAN

# HAMS AND BACON

● ● LARGEST CAPACITY ● ●

IN THE DOMINION OF CANADA.

## PETERBOROUGH, ONT.

ALSO, LINDSAY, OTTAWA AND HULL, CAN.

FOR

# Jute and Cotton



# Bags

In all sizes and qualities and for every purpose,

APPLY TO

## CANADA JUTE CO.

(LIMITED)

17 to 21 St. Martin St.,  
Montreal

The LARGEST and BEST EQUIPPED Bag Factory in the Dominion.

• • •

MODERATE PRICES. EXCELLENT QUALITY,  
GOOD WORKMANSHIP.

# TEES & CO.

MANUFACTURERS OF

# = DESKS

IN GREAT VARIETY

REVOLVING BOOKCASES,

PARQUET FLOORING, &c., &c.

300 St. James Street,

MONTREAL.

THE

# Thos. Davidson Mfg. Co.

MONTREAL,

INVITE ENQUIRIES FOR

## TIN BOXES, CANS, Etc.

For packing Spices, Drugs, Candies,  
Biscuits, etc., etc.

THEY ALSO MANUFACTURE

Stamped, . . . . **TINWARE**  
Japanned & Plain

ADVERTISING SIGNS, ON TIN, ETC.

INFORMATION AND PRICES CHEERFULLY GIVEN.

THE THOS. DAVIDSON MFG. CO.

FACTORY AND OFFICE: ST. CUNEGONDE, QUE.  
SAMPLE ROOM: 474 ST. PAUL ST., MONTREAL.

# THE GLOBE FURNITURE CO.

(LIMITED.)

WALKERVILLE, ONT.

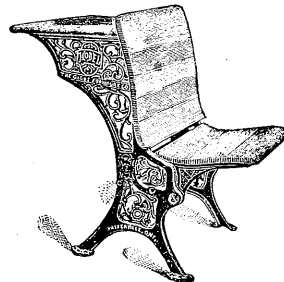

OUR SPECIALTIES:

SCHOOL DESKS,  
CHURCH PEWS

. . . AND . . .

## SEATING

of all kinds for Churches, Halls,  
Opera Houses, etc.

BANK, STORE AND OFFICE FITTINGS.

DESIGNS AND ESTIMATES

FURNISHED.

Ladies' Secretaries,  
Sewing Tables,  
Card Tables, etc.

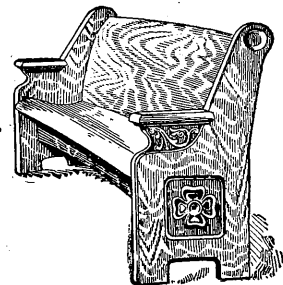

GEO. W. SADLER.

GEO. F. HAWORTH.

# ROBIN, SADLER & HAWORTH,

... MANUFACTURERS OF ...

OAK TANNED

## LEATHER BELTING.

COR. WILLIAM AND SEIGNEURS STS.,

FACTORIES AT  
MONTREAL AND TORONTO,

MONTREAL.

THE  
**CANADA SCREW CO.**

(LIMITED.)

HAMILTON, ONT.

Manufacturers of all kinds of Wood Screws, in flat, round and oval heads; in Iron, Brass and Bronze; Nickel and Silver Plated and Polished. Screw Hooks and Eyes, Jute Hooks, Machine Screws, Stove Bolts, Tire Bolts, Sleigh Shoe Bolts, Sink Bolts, Stove Rods, Wire Nails, Iron and Copper Rivets and Burrs. Wire: Bright, Annealed and Oiled and Annealed; Straightened Wire cut to length.

Patented  
Cold Forged  
Products: { *Spur Pointed Wood Screws,*  
*Fluted Tire Bolts,*  
*Rodgers' Drive Screws &c.*

BRANCH WAREHOUSES:

MONTREAL: 385 &amp; 387 ST. PAUL STREET.

TORONTO: 77 BAY STREET.

## CROSSMAN & LAWS,

... MANUFACTURERS OF ...



## FURNACES

For HOT AIR ALONE

... AND ...

HOT AIR and HOT WATER COMBINED.

Stoves, Ranges,

Hollowware, Sinks,

General Castings, etc.

AMHERST, N.S.



# ONTARIO GLOVE WORKS, BROCKVILLE, CAN.

MANUFACTURERS  
.. OF ..

.. GLOVES ..  
... MITTS ...  
MOCCASINS

Superior Workmanship.  
Finest Material.  
Longest Experience.  
Goods made on Honor.  
Sold on their Merits.

Our "MOCHA" GLOVES are UNEQUALLED.

Compare our Goods and satisfy yourself.

SOLE MANUFACTURERS CELEBRATED

## Chester & Workers' Suspenders.

Only Suspender having the Graduated Elastic Cord—BUY THEM.

### DOMESTIC SPECIALTY CO.,

MANUFACTURERS OF

#### Blackings & Cements, &c.,

OF A HIGH GRADE QUALITY.

British Military "B. M." Blacking, Ladies' Fine Shoe Dressing, "Black Diamond" Stove Polish, "Ferri" Carbured Stove Polish, "Odorless" Stove Pipe Varnish, Clarified Leather Cement, Rubber Cement, Bicycle Liquid Tire Cement.

We guarantee all our Goods. Write for Price List.

ADDRESS:

DOMESTIC SPECIALTY CO., HAMILTON, ONT., CAN.

### Chapman's

YOUNG-PE BUCK RAILROAD



## GLOVES.

WILL NOT HARDEN,

Largest, Best Equipped Tannery, Heavy Goods only,  
All kinds, Lowest Prices.

Users of Glove Leather should send for Samples of our Mocha, Oil Tan and Napa Buck, Kid, etc. THEY ARE RIGHT.

WINGHAM, ONT.

## RIGBY

POROUS WATERPROOF

# CLOTHING

AND CLOTH.



IN USE EVERYWHERE FOR

Gentlemen's Overcoats,  
Ladies' Ulsters and Dresses,  
Bicycle Suits,  
Coachmen's Livery Coats, etc.



For Sale by all Dry Goods and Fur-  
nishing Houses.

## McKelvey & Birch,

MANUFACTURERS OF

Refrigerators, Ships' Lanterns,  
Cheese Factory Supplies,  
Tin and Copper Ware,

... JOBBERS IN ...

Tinsmiths', Plumbers', Steam and  
Gas Fitters' Supplies.

69 & 71 BROCK ST., KINGSTON, Ont.

## THOMPSON & CO.,

SHERBROOKE, QUE.

MANUFACTURERS OF

## Bobbins and Spools

OF EVERY DESCRIPTION FOR

WOOLEN, COTTON AND ROPE MILLS,

... ALSO ...

General Hardware Turnings.

WRITE US.

... THE ...

## FEATHERSTON PIANO CO'Y,

(LIMITED.)

PIANO MANUFACTURERS.

OFFICE and FACTORY,

443 ST. JAMES STREET,

Montreal, P.Q.

• • •

Foreign Correspondence Solicited.

## S. S. KIMBALL,

MANUFACTURER OF

Champion Fire **AND** Burglar-Proof **SAFES**

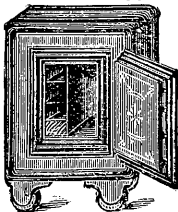

Vault Doors,  
Stump and Stone Extractors,  
Cash and Parcel Railways,  
Leavitt's Dehorning Clippers, &c.

577 Craig Street,

MONTREAL.

P. O. BOX 945.

## The Ames-Holden Co., Ltd.

MONTREAL, TORONTO, WINNIPEG, VANCOUVER, VICTORIA,  
QUE. ONT. MAN. B.C. B.C.

... ALL KINDS OF ...

## HIGH CLASS FOOTWEAR

AND SOLE SELLING AGENTS FOR THE

## GRANBY RUBBERS.

## The PRATTE PIANO Co.

Manufacturers of the PRATTE PIANO and Dealers in

## Pianos, & Organs,

AND MUSICAL INSTRUMENTS,

SPECIALTY:

Artists' Pianos,  
Pianos in Rare Woods, and  
Pianos in Classical & Odd Styles.

1676 Notre Dame St. MONTREAL.

WRITE TO

## J. S. PALMER,

SHERBROOKE, QUE.

For Quotations on

**VENEER** | *Tooth Picks, -*  
| *Cigar Lighters,*  
| *Boxes, Etc. - -*

© ALSO ©

## Pure Maple Sugar

AND SYRUP

... IN CAR LOTS.



**BOATS** FOR PADDLING,  
ROWING, SAILING,  
STEAMING.  **Small Craft** FOR  
ANY  
PURPOSE.

.. ARE FURNISHED BY THE ..

**Dominion Boat Co.,**

A. C. KNAPP, Manager.

**KINGSTON, ONT.**

50 YEARS IN USE.

.. SHARP'S ..  
**BALSAM OF HOREHOUND**  
AND ANNISEED FOR  
**CROUP, COUGHS AND COLDS.**

AGENTS WANTED in Canada  
(West of New Brunswick) and the  
United States.

**ARMSTRONG & CO.,**  
PROPRIETORS,  
P.O. Box 9, **ST. JOHN, N.B.**

ESTABLISHED 1867.

.. AMHERST ..  
**BOOT AND SHOE MFG. CO.,**  
Wholesale Boot & Shoe Manufacturers,  
**AMHERST, Nova Scotia.**

The leading Rubber Shoe House in the Provinces.

**ST. JACOB'S GLUE CO.**

MANUFACTURERS OF ..

Pure  
Hide Stock **GLUES.**

Excellent qualities suitable for Pianos, Organs,  
Furniture and all Woodenware Goods.

**ST. JACOBS, ONT.**

Telephone 140.

**JOSEPH DOUST,**  
LAW FORMS,  
Law and . . Stationer,  
LITHOGRAPHER, PRINTER, &C.  
58 Adelaide Street East,  
**TORONTO, ONT.**

**Miramichi Stone**

A beautiful rich Olive Sandstone, easily wrought, does  
not lose its color, and of great durability, also

**WOOD-PULP STONES, GRIND STONES, BRIDGE STONE, ETC.**  
Samples and prices on application. Enquiries solicited.

**C. E. FISH, FRENCH FORT QUARRIES, NEWCASTLE, N.B.**

TELEPHONE 866,

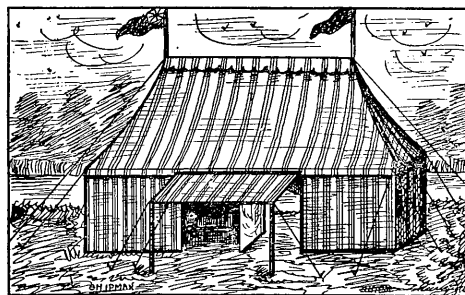

**ROBT. SOPER,**

369 BAY STREET N., **HAMILTON, ONT.**

MANUFACTURER OF

**Sails, Tents, Awnings and Flags,**

**WATERPROOF HORSE AND WAGON COVERS.**

Tents to rent and made to order of all kinds and sizes.  
Folding Cots, Chairs, Rockers, Camp Stools, etc.  
Men's Black Oiled Clothing of all kinds.  
Canvas of various widths and numbers for all purposes.  
Rope, Marline Blocks, Thimbles, Grommets, and various Fittings  
for Boats, Awnings and Tents, too numerous to mention.

**ALSO LIFE PRESERVERS.**

Canvas Sacks for Delivering Coal.

A Call Solicited.



CHAMPION.

ESTABLISHED 1852.

# R. CAMPBELL, HAMILTON POTTERY

MANUFACTURER OF ALL DESCRIPTIONS OF

Fire Brick Stove Linings,  
English Grate Linings and  
Art Tile for Stove Decoration.

ALSO, EVERY DESCRIPTION OF

Rockingham Ware, Yellow Ware, Stone Ware and Bristol Ware

*Careful attention given to all Special Lines of these Goods.*

Bottles, Jars, Jugs, etc., made suitable for putting up Extracts, Jams, Patent Articles, Ginger Beer, etc. Sole Manufacturer of the Celebrated Champion Rock Tea Pot. Fire Clay, Sand and Fire Brick for Building and Furnace Work constantly on hand. . . . .

*PRICES AND TERMS CHEERFULLY GIVEN ON APPLICATION.*

OFFICE and FACTORY :

96 to 118 South Locke Street,

**HAMILTON, Ont.**

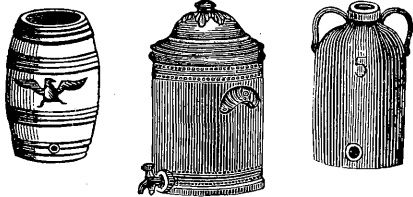

**HART BROS. &  
LAZIER,**

**QUINTE STONEWARE  
WORKS.**

**Chemical Ware**   
*A SPECIALTY.*

All Goods made from best Imported Fire Clay.  
Send for Illustrated Catalogue.

**WORKS: MILL STREET,  
BELLEVILLE, Ont.**

## IMPERIAL OIL CO.

(LIMITED,)

**PETROLEUM REFINERS,**

.. MANUFACTURERS OF ..

*Lubricating Oils, Paraffine Wax  
and Candles,*

**RAILWAY AND STEAMSHIP OILS  
A SPECIALTY.**

BRANCHES:

HAMILTON,  
STRATFORD,  
LONDON,  
TORONTO,  
KINGSTON,  
MONTREAL,  
QUEBEC,

WINDSOR,  
PETERBOROUGH,  
ST. JOHN, N.B.,  
MONCTON,  
HALIFAX, N.S.  
WINNIPEG,  
VANCOUVER, B.C.

Works and Head Office:

**PETROLIA, CANADA.**

The  
**Aeolian Ventilator.**

(PATENTED MAY 26TH, 1894.)

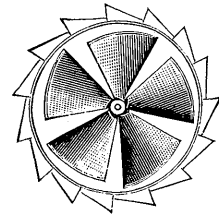

Cut showing inside of Ventilator.

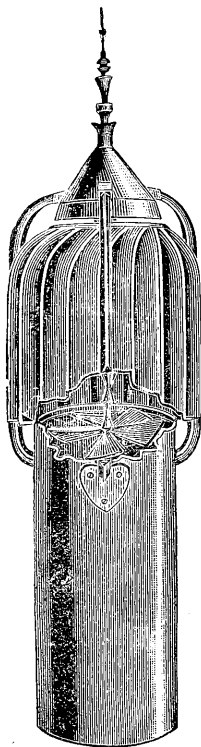

**W**E GUARANTEE our Ventilators to give perfect satisfaction wherever used. Manufactured and especially suitable for

**Public Buildings, Hotels, Churches, School Houses, Banks, Factories, Offices, Private Residences, etc., etc.**

**T**HIS VENTILATOR has proved itself to be superior to any that has been placed before the public. It has proved by the tests which have been made its adaptability for ventilating large buildings, closet rooms, vaults of churches, balk chimneys, schools, factories, stables, etc. It is fitted with a screw on the inside, by means of which a constant current of air is established. The chief feature of this Ventilator is that its motive power is derived not only from the slightest current of air, but the difference of temperature within and outside the building. Every Ventilator is guaranteed to give entire satisfaction. Testimonials obtained on application. This Ventilator is very ornamental in appearance and substantial in make. Estimates for Copper Ventilators given on application.

**SOME PLACES WHERE THE AEOLIAN VENTILATOR IS USED IN MONTREAL.**

- |                                       |  |                                    |
|---------------------------------------|--|------------------------------------|
| C. T. VIAU, . . . . . 6 assorted      | LA BANQUE DU PEUPLE, . 4 of 24 in.     | SISTERS OF MERCY . . . 1 of 12 in. |
| SISTERS OF PROVIDENCE, . 2 of 18 in.. | E. W. MUDGE, . . . . . 2 of 4 in.      | S. KOLBER, . . . . . 2 of 8 in.    |
| COLLEGE OF PHILOSOPHY, . 3 of 22 in.  | T. CREVIER & FILS, . . 5 of 6 in.      | AND MANY OTHERS,                   |
|                                       | MONTREAL DRILL HALL, . . . 5 of 48 in. |                                    |

**LESSARD & HARRIS,** SOLE PROPRIETORS AND MANUFACTURERS.

Office: 42½ Craig Street,

**MONTREAL, Que.**

The above cut shows a part of the interior of the Ventilator,

**J. B. SNIDER,**

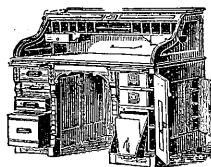

MANUFACTURER OF

**Office, School,  
Church and Lodge**

**FURNITURE.**

Estimates given on Bank, Office, Court House and Store Fittings.

**WATERLOO, ONT.**

DAVID LAMONT. DONALD LAMONT.

**LAMONT GLASS CO'Y.**

**NEW GLASGOW, N.S.**

MANUFACTURERS OF . . .

**Flint Glass Lamp Chimneys  
. . . and Lantern Globes, . . .**

**Blown Glass Goods, . . . . .**

**Pressed Glass Goods, . . . . .**

**Moulded Glass Ware, . . . . .**

**Proprietary Medicine Bottles,**

**Water Gauge Glasses, etc. . . .**

**LEAD GLASS A SPECIALTY.**

SPECIAL ATTENTION GIVEN TO PRIVATE  
. . . MOULDS . . .

**Lettered Prescription Bottles  
A SPECIALTY.**

# CHRISTIE BROS. & CO.,

# AMHERST, N.S.

ESTABLISHED 1863.

MANUFACTURERS OF

Coffins and  
Caskets,

BOTH in

**CLOTH  
AND VARNISHED  
WORK.**

IMPORTERS AND DEALERS  
IN ALL KINDS OF

Undertakers'  
Supplies,

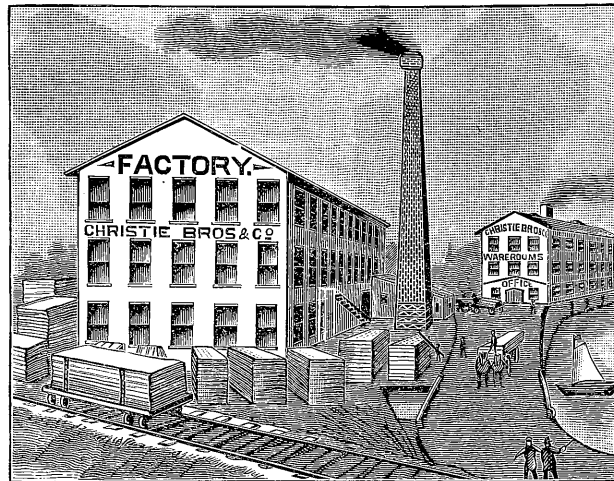

ALSO, MANUFACTURERS OF

Trunks,

Bags and

Valises.

Special attention given to **SAMPLE TRUNKS** of all kinds.  
Lumber, Mouldings and Carriage Hubs always in stock.

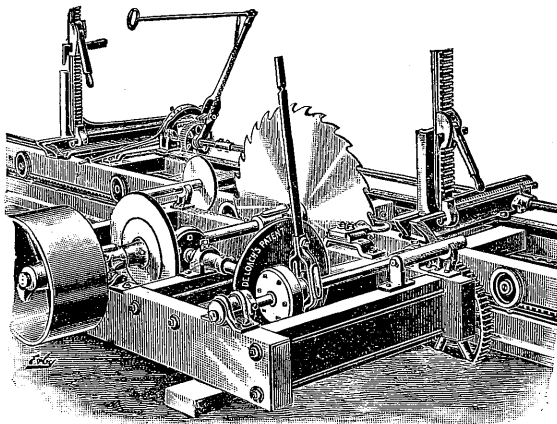

WE MANUFACTURE

De Loach Patent Board Mill, Shingle Mill, Drag Saw  
Mill, Half and Full Circle Dederick Hay Press,  
One and Two Horses Threshing Machines,  
Straw Cutters and Horse Hay Rakes.

Send for Catalogue and Price List. Address,

**O. CHALIFOUX & FILS,  
ST. HYACINTHE, P.Q.**

Mention the Machine needed, for special discount.

## MONTREAL

## TENT, AWNING AND TARPAULIN CO.

W. H. GRIFFIN, Manager.

MANUFACTURERS OF

**Sails, Horse and Wagon Covers,  
Tents, Bags and Aprons,  
Awnings, Flags of all Nations.  
Tarpaulins, Cork Fenders,  
Oil Clothing, Life Buoys and Belts.  
and all kinds of Canvas Goods.**

MAKERS OF THE STANDARD COAL BAG.  
TENTS, TARPAULINS & FLAGS FOR HIRE.

### SAIL MAKING A SPECIALTY.

Awnings put up, taken down, stored and Insured  
at lowest rates.

249 & 251 COMMISSIONERS ST.,

 **MONTREAL.**

# W. W. CHOWN & Co.

Canadian Tin  
and Stamping Works.

MANUFACTURERS OF

Stone's Lanterns,  
Pieced and Stamped Tinware,  
Empire State Milk Cans,  
Cheese Hoops, Presses and Vats,  
Curd Knives, &c.

... JOBBERS OF ...

Tinners' Trimmings,  
Pumps, Sinks, Brushes,  
Brooms, &c.

OFFICE AND FACTORY: MILL ST.

BELLEVILLE, ONT.

# W. R. THOMPSON,

WHOLESALE AND RETAIL DEALER IN

# LUMBER,

Lath, Shingles, Staves and Heading, Broom Handles,  
Exporter of Maple Rollers, &c., &c.

TEESWATER, ONT., CAN.

# O. D. COWAN,

MANUFACTURER OF

Flexible Steel Harrows, Spring Tooth Steel  
Harrows, Carriage Gears, Clothes Wringers,  
Washing Machines, &c., &c.

GANANOQUE, ONT.

# GANANOQUE SPRING & AXLE CO.,

MANUFACTURERS OF

Fine Car,  
Carriage & Spiral **SPRINGS,**  
Wagon and Carriage Axles, Also Wagon Skeins,  
And the Beaver Bolt Clipper.

GANANOQUE, ONT.

# Wm. Parks & Son

(LIMITED.)

ST. JOHN, N.B.,

Cotton Spinners, Bleachers,  
... Dyers. ...

AND MANUFACTURERS

**Grey Cottons,** . . . . .  
**Yarns, Single and Double** . . . . .  
**Carpet Warp,** . . . . .  
**Beam Warps,** . . . . .  
**Chain Warps,** . . . . .  
**Hosiery Yarns,** . . . . .  
**Ball Knitting Cotton,** . . . . .  
**Shirtings, &c. &c.** . . . . .



AGENTS:

DAVID KAY,  
Fraser Building, MONTREAL, Que.  
WM. HEWETT & CO.,  
30 Colborne St., TORONTO, Ont.

# KAY ELECTRICAL MFG. CO.

255 JAMES ST. N., HAMILTON, ONT.

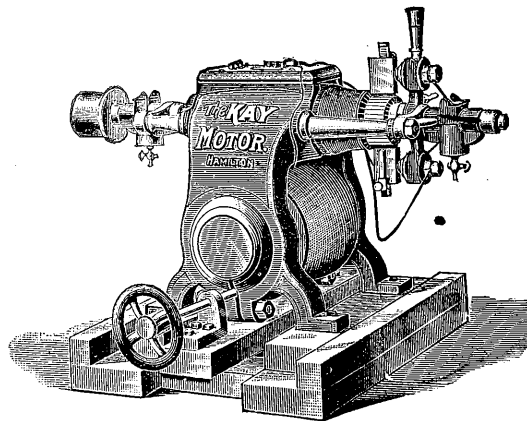

... MAKERS OF ...

**ELECTRIC MOTORS,**  
**DYNAMOS, PLATING MACHINES,**  
**TRANSFORMERS, &c.**

Please let us know your requirements.  
Write for latest prices and testimonials.

**PETER HAY,**

.. GALT, ONT. . .

MANUFACTURER OF

**MACHINE KNIVES**

OF EVERY DESCRIPTION

FOR

Woodworking, Paper Cutting and  
Leather Splitting

† † **MACHINES**



See Itemised List of Knives in Part II  
of Shipping Manufacturers List.

MILL & POST OFFICE: TELEGRAPH OFFICE & STATION:  
AT EUGENIA, CO. GREY. FLESHERTON ON C.P.R.

**Toronto Hoop and**

AUTHORIZED CAPITAL  
\$50,000.

**Veneer Co'y,**  
(LIMITED.)

Manufacturers of Cheese Bands, Cloth Boards,  
Hoops, Picture Backing, Barrel Staves, Fur-  
niture, Car and Carriage Veneers, Hard-  
... Wood Rotary Cut Lumber. . .

Correspondence invited and Estimates given.  
Export Trade solicited.

J. J. B. FLINT, Pres. Box 933. G. L. GRASS, Secy.

**THE BELLEVILLE  
BOX & BASKET CO., LTD.**

MANUFACTURERS OF ALL KINDS OF

FRUIT AND SPLINT

**BASKETS,**

LARD PACKAGES, SACHEL, MARKET and  
LAUNDRY BASKETS.

Berry Boxes, Grape Baskets,  
Cylinder Butter Packages,  
Fig Boxes, Bottle Capsules,  
Axle Grease Boxes, Etc.

**P. PELOSSE,**

MANUFACTURER OF

**Baskets**

ALL KINDS  
MADE TO ORDER.

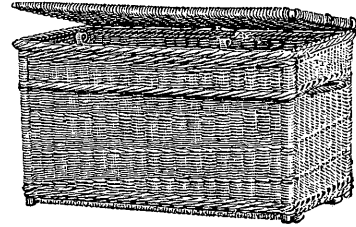

REPAIRING & CHAIR CANING promptly attended to.  
806 & 808 LITTLE CRAIG ST. MONTREAL.

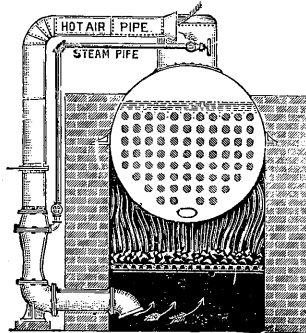

**EARLE'S STEAM & AIR  
INJECTORS,  
EXHAUSTERS, ETC.**

For burning Hard and  
Soft Goal Screenings, Run  
Mine or Lump Coal; Saw  
Dust; Tan Bark, Bagasse,  
or any refuse fuel under  
Steam Boilers.  
Highest Medal and Di-  
plomas given at the  
World's Columbian Ex-  
hibition, Chicago, 1893.  
The best Blower in the  
market for Steam Boilers.  
Write for Illustrated  
Catalogue, etc., to

**S. R. EARLE, BELLEVILLE, Ont., Can.**

**OAKVILLE  
BASKET FACTORY,**

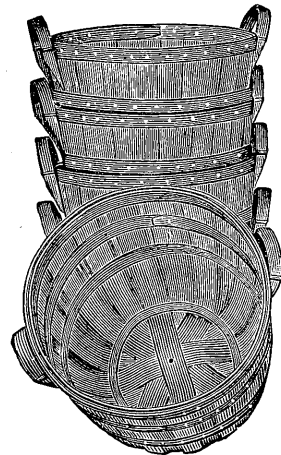

MANUFACTURERS OF  
ALL KINDS OF

**SPLINT  
BASKETS.**

Viz:

1, 2 and 3 Bushel; Small, Medium and Large Clothes;  
Nos. 2, 3, 4 & 5 Market; Small, Medium and Large  
Satchels; Butcher; Delivery; Crockery; 5 and 10 lb.  
Grape; 12 & 16 qt. Fruit; also Strawberry & Plant Boxes.

ADDRESS:

**THE OAKVILLE BASKET CO.  
OAKVILLE, ONT.**



# STANDARD GOODS

THE PEOPLE WANT.

## JOHNSTON'S FLUID BEEF,

Put up in tins. The ideal preparation of Beef.

## JOHNSTON'S FLUID BEEF WITH HYPOPHOSPHITES,

(Brand Staminol.) Put up in 2, 4, 8 and 16 oz. Bottles.  
A Food and a Tonic.

## TRIPLE EXTRACT OF BEEF,

(Clarified.) In Bottles, specially prepared for use in cold water and  
with spirituous liquors.

## FLUID BEEF CORDIAL,

Specially prepared for use in Restaurants and Hotels

## MIK GRANULES & MILK GRANULES WITH CEREALS,

The Ideal Infant Foods.

## LEMON PHOSPHATE,

A cooling and tonic drink. This preparation is the natural acid of  
the Lemon combined with Acid Phosphate.

## THE JOHNSTON FLUID BEEF CO., MONTREAL,

SEND A

## TRIAL ORDER TO F. W. ROWE & CO.

Ginger Ale, Cream Soda, Lemon Soda, Cham-  
pagne Cider, Ginger Beer, etc.

639 LAGAUCHETIERE ST., MONTREAL.

We hold Medals from the Centennial Exposition,  
Philadelphia; Paris, France; Ottawa, Ont., and others.

## J. E. DOYLE & CO.

MANUFACTURERS OF

# CORKS.

IMPORTERS OF

Corking and Capping Machines, Bottle Capsules,  
Bottling Wire, Tin Foil, Wood Tops,  
Life-Preservers, &c., &c.

421 ST. JAMES STREET,

MONTREAL.

# C. R. SOMERVILLE

LONDON, CANADA,

MANUFACTURER OF

## Paper Boxes

AND



## Confectioners' Specialties. . .

Somerville's "MEXICAN FRUIT" and Somerville's  
"PEPSIN"

## CHEWING GUMS

are Medicinal Gums and have a world-wide  
reputation.

WRITE FOR PRICES.

C. R. SOMERVILLE,

LONDON, CAN.

KINDLY ORDER

## Gurd's

GINGER ALE,  
VERY FINE.

SODA WATER,  
APPLE NECTAR  
SELTZER, ETC.

2 Gold, 2 Silver, 3 Bronze Medals and 13 Diplomas  
awarded us for Superior Excellence.

CHARLES GURD & CO.,

MONTREAL:

Orders promptly attended to.

## P. Freyseng & Co.

MANUFACTURERS AND IMPORTERS OF

# CORKS,

Corking Machines, Bottle Capsules, Bottling  
Wire, Tin Foil, Cork Life-Preservers,  
Corkwood, etc., etc.,

QUEEN ST. EAST,  
COR. SUMACH.

TORONTO.

# MILLER & CO.

Packers <sup>AND</sup> Preservers  
OF THE

## LOG CABIN BRAND



Extra

Quality

CANNED FRUITS, VEGETABLES,  
Etc., Etc.

*Special attention given to Export Orders.*

TRENTON, Ont., Canada.

ESTABLISHED 1843.

INCORPORATED 1892.

**THE T. H. TAYLOR CO.,**  
(LIMITED.)

**WOOLEN and FLOUR**  
MANUFACTURERS,

CHATHAM WOOLEN MILLS,  
BEAVER AND DAISY FLOUR MILLS,  
CAPACITY, 500 BARRELS.

CHATHAM, Ontario.

**WM. BRAMLEY,**  
**MANUFACTURING JEWELLER,**

ALL DESCRIPTIONS OF

*Gold and Silver Jewellery  
Made to Order.*

Rings of all descriptions.

Largest Variety in Canada.

CORRESPONDENCE SOLICITED.

643 Craig Street,

MONTREAL.

# Whitlaw, Baird & Co.,

## MILLERS

... AND ...  
COMMISSION MERCHANTS,

BRANDS:

MAGYAR, PASTRY, THE STAR, FAMILY,  
BRIDAL ROSE, BAKERS'.

DEALERS IN WHEAT, BARLEY, PEAS, OATS, ETC.  
PARIS. ONT.

A. C. MILLER.

W. R. WRIGHT.

A. W. HEPBURN.

**A. C. MILLER & CO.**  
PACKERS OF



*Choice Fruits.  
Vegetables. . .*

SWEET CORN A SPECIALTY.

FACTORIES:

PICTON, ONT.

BRIGHTON, ONT.

## J. L. GOODHUE & CO.

MANUFACTURERS OF

### Leather : Belting

AND LACE LEATHER,

*Danville, Que.*

## Dominion Rolled Plate Co.,

MANUFACTURERS OF

(LIMITED.)

Gold and Rolled Plate Stock,  
Rolled Plate Chains,

GEM, DIAMOND AND FANCY RINGS  
OF EVERY DESCRIPTION.

123 & 125 VITRE STREET,

HENRY J. MILLER,

GENERAL MANAGER.

MONTREAL.

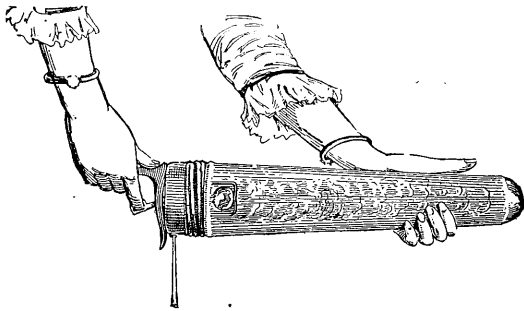

AUTHORIZED CAPITAL, \$50,000.  
**THE CANADIAN FIRE EXTINGUISHER CO., LTD.**  
 7 & 9 ST. PETER ST., MONTREAL, CAN.  
 Larger Sizes for Fire Depts. of Cities, Towns, Villages.

**.. T. POLITO, ..**  
**Dominion Glass Bending Works.**

All descriptions of Glass Bending work done promptly and in a thorough artistic manner.  
 The only factory in Canada doing this work in all its branches.

Correspondence solicited. References on application.

356 ST. HYPOLITE STREET.

TEL. BELL, 6728. **MONTREAL, Que.**

**GEO. W. REED,**

SLATE, METAL and GRAVEL

**Roofing,**

**Asphalt Flooring,**

Galvanized *&c., &c.* Roofing  
 Iron and  
 Cornices, Sheathing  
 Skylights, Felts,  
 and Slates,  
 Metal Asphalt,  
 Work Bitumen,  
 to Rosin  
 Order. Cement.



**Refrigerators, Mantels, &c.**

783 & 785 Craig St. MONTREAL.

**Prescott Emery  
 Wheel Co., Ltd,**

PRESCOTT, Ont., Canada.

MANUFACTURERS OF

**Premium  
 Solid Emery  
 Wheels.**

ALSO  
**Waterproof  
 Wheel for  
 Tool and  
 Saw Grinding.**

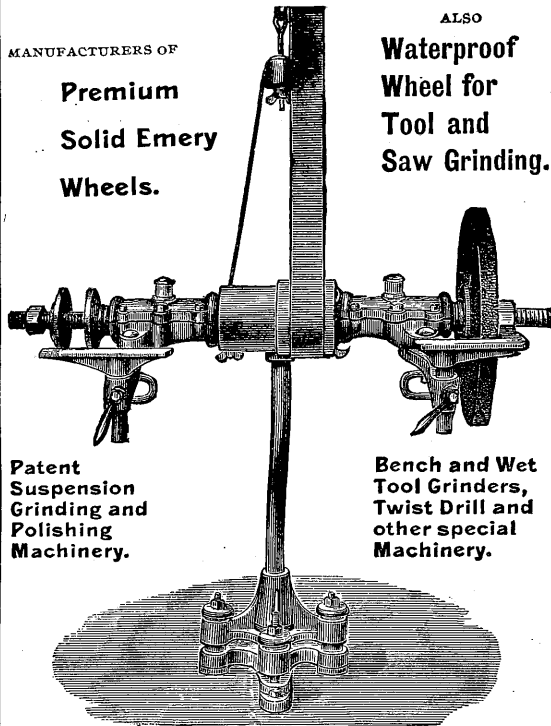

**Patent  
 Suspension  
 Grinding and  
 Polishing  
 Machinery.**

**Bench and Wet  
 Tool Grinders,  
 Twist Drill and  
 other special  
 Machinery.**

Send for Catalogue and Price List.

**MEAKINS & CO.**

313 St. Paul St., MONTREAL.

MANUFACTURERS AND IMPORTERS OF

**BRUSHES FOR**

House and Sign Painters,  
 . . . Carriage Painters, . . .  
 . Artists and Decorators, . .  
 . Household and Stable. .

ALSO DRUGGISTS' FINE BRUSHES,  
 HAIR, TOOTH, NAIL BRUSHES, ETC.

NOTE.—Mill and Machinery Brushes to order.  
 Send for prices.

# S. H. & A. S. EWING,

PROPRIETORS AND MANUFACTURERS OF THE

“VIENNA”  
BAKING  
POWDER



*C. M. Putney*

IMPORTERS OF

Cream Tartar, Coffee, Spices and Borax.

MONTREAL COFFEE & SPICE STEAM MILLS,

55 Cote Street,

MONTREAL.

# GOLDIE'S STAR

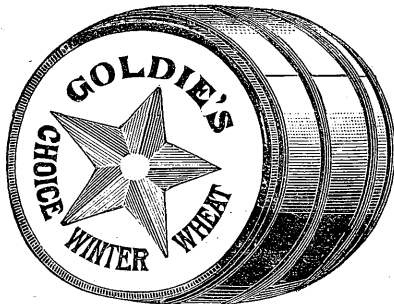

# FLOUR

ALWAYS UNIFORM.

GOLDIE MILLING CO.,  
(LIMITED.)

SUCCESSORS TO DAVID GOLDIE,

*AYR, Ont.*

ESTABLISHED 1860

THE . . .

# People's Mills,

GUELPH, ONT.

CAPACITY 600 BRLS. DAILY.

STANDARD  
BRANDS.

Goldie's Best Patent  
People's  
Ayrshire Rose  
Gilt Edge  
Victoria  
Chancellor Extra

CANNOT BE EXCELLED.

CORRESPONDENCE INVITED.

# JAMES GOLDIE.



Vessot's  
Grain . .  
Grinder,



BEST FEED MILL IN THE  
MARKET.

Was awarded First Prize, Provincial Exposition, Montreal, 1884; Hamilton, 1885. Diplomas at Sherbrooke, 1885, 1891, 1892 and 1895; at Ottawa, 1891 and 1892.

Gold Medal at the World's Fair, Chicago, 1893

We beg to call the attention of Farmers, Millers, etc., to our Improved Grain Grinders, which are giving the best of satisfaction wherever used.

Our Little Champion Grinder, especially adapted to be run by horse power, is sold at a very low figure.

Our Large Sized Grinders, for the use of Millers, etc., give great satisfaction. Will grind from twenty to fifty bushels per hour; do twice as much work with the same power required to run ordinary mill stones.

SATISFACTION GUARANTEED.

Over 1,500 of our grinders now in use in Dominion of Canada.

Are easily operated, do not require an expert to dress them.

ASK FOR CIRCULAR.

AGENTS WANTED

Our Specialties—Vessot's Grain Grinder and Vessot's Car Axle Lubricator.

S. VESSOT & CO.,

SOLE MANUFACTURERS,

JOLIETTE, P.Q., CANADA.

# Henry Porter,

**MONTREAL,**

MANUFACTURER OF

\* **OAK TANNED** \*

## LEATHER BELTING.

*Carriage and Furniture Leathers,*

*Colored Leathers,*

*Russian Calf, Glove Grain, Dongola Cow,*

*Rungola Calf,*

*Buff Moccasin Leather,*

*Lace Leather,*

*Halters, Bridles, Reins,*

**GOODYEAR MACHINE WELTING,**

*Trunk and Bag Leathers.*

# R. T. HOPPER & CO.

Miners, Shippers and Manufacturers of

## > MINERALS

Asbestos, Phosphate, Mica,  
Soapstone, Talc, Chromic Iron,  
Portland Cement, &c

MANAGING DIRECTORS:

THE ANGLO-CANADIAN ASBESTOS CO., LTD.

THE ENGLISH PORTLAND CEMENT CO., LTD.

THE MONTREAL & KOOTENAY MINING CO., LTD.

314 Board of Trade Building,

**Montreal, Can.**

The . . .

# Packard Electric Co.,

LIMITED,

**ST. CATHARINES, ONT.,**

MANUFACTURERS OF

THE HIGH GRADE

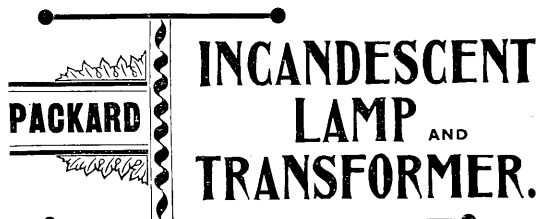

DEALERS IN

**ELECTRICAL SUPPLIES.**

LAMPS STRONGLY GUARANTEED.

PROMPT SHIPMENTS MADE.

Prices and Catalogues mailed on application.

**KING BROTHERS,**

15 BELLS LANE,

Quebec.

LUMBER, ASBESTOS,  
CHROMIC IRON.

MANUFACTURERS AND SHIPPERS OF

SPRUCE AND PINE  
**DEALS AND BOARDS,**Railway Ties, Telegraph Poles,  
Cedar Pickets, etc.Mills at River Ouelle, Lyster, Kingsburg,  
Pabos, Cedar Hall.Asbestos—Crude, Fibreized and Paper Stock  
—Hampden Mine, Thetford.

Chromic Iron Mine—Black Lake.

**BIETTE & CO.**  
CHESLEY, Ont.

MANUFACTURERS OF

Cheese Boxes,  
Cheese Box Hoops and Heading,  
Butter Tubs and Firkins,  
Apple and Flour Barrels,

ALSO DRESSED LUMBER ALL KINDS.

**SAMUEL ROGERS & Co.**  
TORONTO, Ont., Canada,

OUR ASSOCIATE FIRMS:

FAIRBANK, ROGERS & CO., PETROLIA.  
THE ROGERS MORRIS CO., LTD., OTTAWA.  
ROGERS, ROBERTSON & CO., MONTREAL.  
HAMILTON OIL CO., HAMILTON ONT.MANUFACTURERS, IMPORTERS AND WHOLESALE DEALERS IN  
Burning and Illuminating... OILS, GREASES, ...  
PETROLEUM PRODUCTS,

And all other Oils known to Trade and Industries.

Our "Peerless Brands" Cylinder, Valve, Engine,  
Dynamo and Signal

Are Favorite Reliable Oils.

**NESS, McLAREN & BATE,**

SUCCESSORS TO T. W. NESS &amp; CO.

MANUFACTURERS OF

LONG DISTANCE, MAIN LINE AND WAREHOUSE  
**TELEPHONES**Headquarters for Electric Light, Telephone,  
Telegraph and General**ELECTRICAL SUPPLIES.**

749 Craig Street, MONTREAL.

**Acadia Powder Co., Ltd.**

129 HOLLIS ST., HALIFAX, N. S., P. O. 520.

MANUFACTURERS OF . . .

**BLASTING  
MINING  
AND SPORTING POWDERS**Dynamite and Safety Flameless Powder  
for Gaseous Coal Mines.Agents for ELECTRIC BLASTING APPARATUS, ELECTRIC FUSE,  
SAFETY FUSE AND DETONATORS.**JOHN COWAN,**

3 DALHOUSIE STREET,

Montreal,

MANUFACTURER AND DEALER

Liquor Ammonia,	Soluble Oil,
Carbonate " "	Copperas,
Household " "	Tin Spirits,
Sulphate " "	Bichrome Potash,
Sal Soda,	Sulph. Acid,
Bicarb. Soda,	Muriatic " "
Sulph. of Copper,	Nitric " "
Nitrate of Iron,	Acetic " "
Acetate " "	Milk Test Acid,
Iron Liquors,	Oxide of Manganese
	Lump Alum.

**SLEEPER & AKHURST,**  
General Founders and Machinists,

MANUFACTURERS OF

*Mowers, Horse Rakes, Plows,  
Cider Presses, Feed Cutters,  
Board Planers, Jointers, Shingle Machines,  
Clapboard Machines and Planers.*

SWEEP SAWING MACHINES AND ALL KINDS OF MILL  
WORK, ETC.

— COATICOOK, P.Q.

**WELLAND VALE MFG. CO.**

ST. CATHARINES, ONT., CANADA,

.. MAKERS OF ..

**Axes <sup>AND</sup> Edge Tools,**

*Scythes, Forks, Hoes, Rakes, Heath's  
and Lightening Hay Knives.*

PICKS, MATTOCKS, BROAD, BENCH, BOYS' AND  
HUNTERS' AXES, BRUSH HOOKS  
AND GRUB HOES,

For HOME and FOREIGN TRADE.

**WOODBURN SARVEN WHEEL CO.**

St. Catharines, Ont., Canada,

MAKERS OF .. . .

*SARVEN PATENT WHEELS,  
WARNER PATENT WHEELS,  
\* SHELL BAND WHEELS,  
COMPRESSED BAND WHEELS,  
FINE WOOD HUB WHEELS,*

.. AND ..

WHEELS FOR ALL STYLES OF VEHICLES  
FOR HOME AND FOREIGN TRADE.

**Canada Axe & Harvest Tool Co.**

MONTREAL, QUE.

MAKERS OF .. . .

**AXES AND EDGE TOOLS,**

*Scythes, Forks, Hoes, Rakes, Picks,  
Mattocks, Boys', Hunters', Bench  
and Broad Axes,*

**BRUSH HOOKS, GRUB HOES AND HAY KNIVES,**  
FOR HOME AND FOREIGN TRADE.

**The Dominion Snath Co.,**

... WATERVILLE, QUE.

MANUFACTURERS OF

*Patent Swing Socket and  
all other approved . . .*

**SCYTHE  
SNATHS**

BROOM HANDLES AND TURNED GOODS,

Children's Sleds and Sleighs, Store Trucks,  
Clothes Dryers, Wall Dryers,  
Folding Tables, etc.

**A. S. WHITING MFG. CO.**

Cedar Dale, OSHAWA, Ont.,

.. MAKERS OF ..

*Scythes, Forks, Hoes, Rakes, Hay Knives.  
Brush Hooks, Grub Hoes, Picks,  
Mattocks and Edge Tools,*

Boys', Hunters', Bench,  
Broad and Chopping **AXES.**

SPECIAL ATTENTION TO FOREIGN ORDERS.

**O. S. Rixford Mfg. Co.**

BEDFORD, Que.,

MAKERS OF .. . .

**AXES AND EDGE TOOLS,**

*Scythes, Forks, Hoes, Rakes, Picks, Mat-  
tocks, Boys', Hunters', Bench  
and Broad Axes,*

**Brush Hooks, Grub Hoes and Hay Knives,**  
FOR HOME AND FOREIGN TRADE.

**Files and Rasps.**

**"BEAVER" BRAND,**

WARRANTED.

MANUFACTURED BY .. .

The Beaver File Works Co.,

— LEVIS, P.Q.

## Why Windsor Salt is the Best:

The reason is that it is the only salt manufactured by the **VACUUM PROCESS** in Canada. This system makes a purer, finer salt, very even in crystal, and more readily dissolved than any salt made by the old process.

# Windsor Salt

Is shipped in car lots to any place in Canada.

We ship **ORDINARY FINE SALT** in barrels, 280 lbs. net, in 200 lb. and 50 lb. sacks. **TABLE SALT** in wooden boxes, square and round cardboard packages, and in all the ordinary sized cotton bags. **DAIRY SALT** in 20 lb. cotton bags, in 50 lb. and 200 lb. white duck sacks, and in paper lined barrels 280 lbs net. **CHEESE SALT** in 200 lb. white duck sacks and in paper lined barrels 280 lbs. net.

Our capacity is very large, and we can ship on the shortest notice. Prices, samples, or any information can be had by addressing

**The Windsor Salt Works, = Windsor, Ont.**

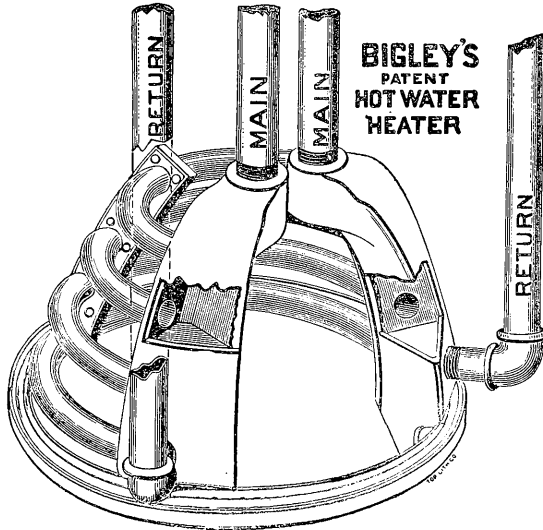

This Heater is specially made for Hot Air Furnaces to be used in combination heating, and adds  $\frac{2}{3}$  heating power to any Furnace.

#### CAPACITY:

Capacity	Price
18 in. will heat 700 feet of 1 in. Pipe, =	\$19.00
20 " " 1,200 " " " " " "	23.00
24 " " 2,200 " " " " " "	29.00
28 " " 3,000 " " " " " "	32.00

.. MANUFACTURED BY ..

**R. BIGLEY,** 96 & 98 Queen St. E.,  
TORONTO.

## Mineral Wool, Sectional Steam Pipe and Boiler Covering.

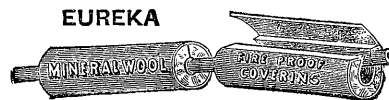

Acknowledged by all to be the best fire-proof non-conductor known to science and used for covering Steam, Hot Water, Hot Air, Cold Water, Gas, Ammonia and Sweating Pipes; Boilers, Domes, Tanks, Breechings and all heated surfaces.

.. WE ARE ALSO DEALERS IN ..

**MINERAL WOOL**, (in bulk) for fireproofing, etc,  
**ASBESTOS GOODS** of every description,  
**ENGINE PACKINGS, &c., &c., &c.**

**Eureka Mineral Wool & Asbestos Co.**

124 Bay Street,  
**TORONTO, Ont.**



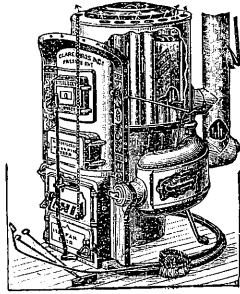

If you have anything to heat, send for a copy of **Our Furnace Book** which tells all about . . .

## PRESTON FURNACES

there are more of them in use than of any other make. . . . .

**CLARE BROS. & CO., PRESTON, ONT.**

EASTERN BRANCH: 160 McGill St.,  
MONTREAL, QUE.

WESTERN BRANCH: 180 Market St.,  
WINNIPEG, MAN.

Toronto Varnish Works,

ESTABLISHED 1873.

**D. A. Mackenzie & Co.**

Manufacturers of all kinds of

# Varnishes

- and -

# Japans.

Office, Factory and Warehouse:

Cor. Eastern Ave. and Strange St.

TELEPHONE 610. TORONTO.

## "STAR" HOT WATER HEATER.

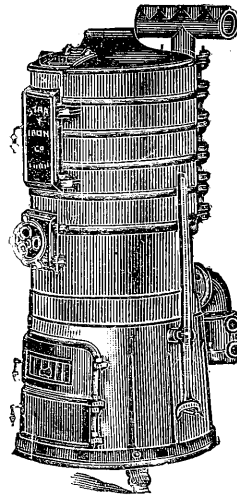

Known as being superior to all others. The only Heater provided with a

**PATENT  
SYPHON  
INJECTOR**

which enables it to heat on its own level. And it has an

**ASH SIFTER,**

which is put in motion by the same handle as the Fire Grate: the sifting is done, the doors being closed, thus preventing ashes to spread in the room.

. . . MANUFACTURED BY . . .

**THE STAR IRON COMPANY,**

590 Craig St., MONTREAL, QUE.

Ask for Catalogues, Testimonials and Price Lists.

**DOWSWELL, BROS. & CO.,  
HAMILTON, ONT.**

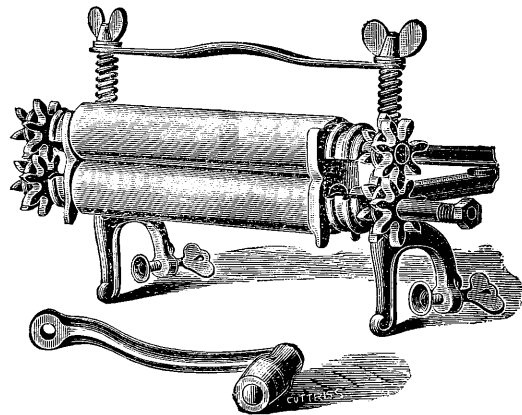

NEW EUREKA WRINGER.

MANUFACTURERS OF

**CLOTHES WRINGERS,** 9 varieties.  
**WASHING MACHINES,** 4 diff't kinds  
**MANGLES,** 3 styles.  
**LEADER BARREL CHURNS.**  
**TRUCKS AND HOSE REELS.**

WRITE FOR PRICES AND CATALOGUES.

**DOWSWELL BROS. & CO.**

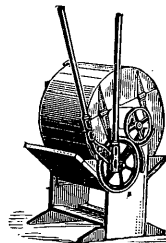

MANITOBA WASHER.

# New Rockland Slate Co.

MANUFACTURERS OF THE

## "ROCKLAND"

UNFADING  
BLUE-BLACK **ROOFING SLATE.**

acknowledged to be one of the strongest slates produced, and to have less breakage than any other.

... ALSO ...

## SLATE SLAB WORK

OF ALL DESCRIPTIONS, VIZ.

*Slate Blackboards, Steps and Risers, Tiles,  
Wash Tubs, Tanks, Urinals, &c.*

The GREAT STRENGTH and NON-ABSORBENT powers of our Slate render it particularly suitable for all the above or any purpose where cleanliness and durability are required. We can ship by both the G. T. Ry. and C. P. Ry. For further particulars, address

**NEW ROCKLAND SLATE CO.,**  
377 ST. PAUL ST., MONTREAL, P.Q.

## Ontario Wind Engine & Pump Co.,

(LIMITED.)

367 Spadina Ave. & 67 to 71 Cecil St.,  
TORONTO, ONT.

Manufacturers of and Dealers in  
STEEL and WOODEN

### WIND MILLS

for Power and Pumping Purposes.

Steel Towers and Trestles, Railway Tanks and Pumps, Horse Haying Tools, Iron and Wood Pumps, Brass Spraying Pumps, Wood Tanks, Saw Tables, &c., &c.

Illustrated Catalogues free upon application.  
Estimates cheerfully given.

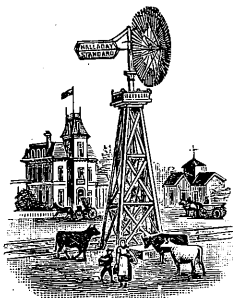

## UNION CARD AND PAPER CO'Y,

8 Latour St., MONTREAL,

... MANUFACTURERS OF ...

Glazed,  
Enamelled and  
Coated

# PAPERS

Photo Mounts and Mounting Boards,

Bevelled, Gilt, Embossed, Tinted, or Printed in  
Gold or Color.

## PLAYING CARDS AND CARD BOARDS

OF ALL KINDS.

# SCALES.

COUNTER, PLATFORM,  
DORMANT, ROLLING MILL,  
HOPPER, COAL,  
TRACK SCALES, &c., &c.



... MANUFACTURED BY ...

## The Gurney Scale Co.,

(ESTABLISHED 1836.)

HAMILTON, ONT.

CANADA.

Write for Illustrated Catalogue, and Book of Testimonials on Large Scales.

## MUNRO BROS.

### WIRE WORKS,

NEW GLASGOW, N.S.

MANUFACTURERS OF

IRON BEDSTEADS, With WOVEN WIRE SPRING,  
(LATEST PATENT.)

WOVEN WIRE RAILWAY FENCING PICKET WIRE.

(ALL SIZES OF MESH.)

Spring Mattresses, Cots,  
Spring Church Pew Cushions,  
Railway Passenger Car Cushions,  
Bank, Office, Grill and Wire Work.

WRITE FOR PRICE LISTS.

W. H. PEARSON, PRESIDENT.

J. T. WESTCOTT,

(Formerly with the United Car Improvement Co.)

GENERAL MANAGER AND TREASURER.

L. L. MERRIFIELD,

(Formerly with the United Gas Improvement Co.)

CHIEF ENGINEER.

THE ...

### Economical Gas Apparatus Construction Co., Ltd.,

TORONTO, ONT.,

ENGINEERS and BUILDERS OF COMPLETE  
GAS PLANTS.

OLD WORKS REMODELLED AND SYSTEMS CHANGED.  
CORRESPONDENCE SOLICITED

# Chatham Manufacturing Co., Ltd.

— CHATHAM, ONT. —



FOR USE IN ONTARIO, QUEBEC, Etc.

THE MOST EXTENSIVE  
MAKERS OF . . .

FARM AND FREIGHT

**WAGGONS,  
LORRIES,  
CARTS  
...AND  
SLEIGHS**

IN THE DOMINION  
OF CANADA . . .

These exhibits carried off highest award at the Worlds Columbian Exhibition, Chicago.

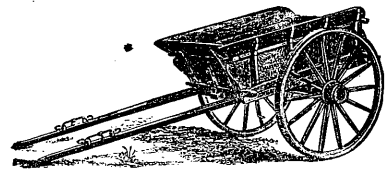

DUMP CART, WITH SPRING FASTENINGS.

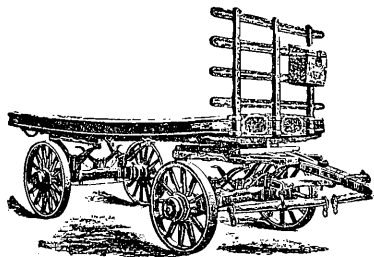

CHATHAM TWO-HORSE SPRING LORRY.

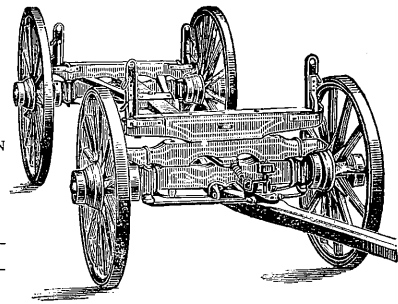

FRONT VIEW OF CHAUTAUQUA GIANT

... CORRESPONDENCE SOLICITED. ...

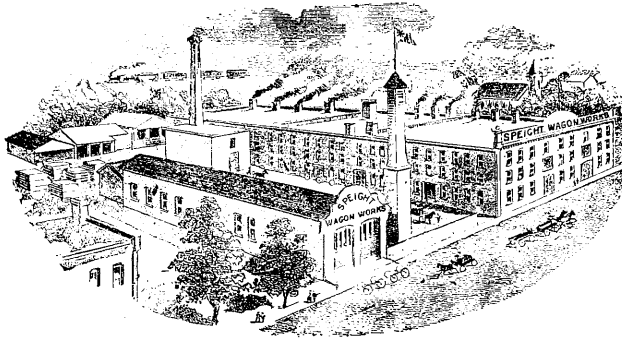

## The SPEIGHT WAGON CO. MARKHAM, ONT.

MANUFACTURERS OF . . .

**Wagons and Buggies,  
...THE "ROSEBERY" CART.**

Heavy Team Wagons, Drays, Lorries,  
Express and Democrat Wagons, Dump Carts,  
Carriages, Sleighs and Cutters.

TORONTO OFFICE AND WAREHOUSE:  
108 Front Street E.

## MCCASKILL, DOUGALL & CO.

D. A. MCCASKILL.

SUCCESSORS TO D. A. MCCASKILL & CO.

JAMES S. N. DOUGALL.



MANUFACTURERS OF  
**VARNISHES  
JAPANS AND  
COLORS . .**

OFFICES: 30 ST. JOHN STREET,

 MONTREAL, CAN.

# CENTURY CO.

MANUFACTURERS OF

"Century Laundry"



- - AND - -



"Standard Electric"

## SOAPS.

Sole Canadian Agents :

**NEWMAN'S NEW YORK BAKING POWDER  
AND STANDARD EXTRACTS.**

Agents for

**TRENT VALLEY CANNING WORKS,  
"LOG CABIN" BRAND,  
FRUITS AND VEGETABLES.**

ADDRESS :

**CENTURY CO.,**

Drawer B.

**PICTON, Ont.**

## BRANTFORD STARCH.

LILY WHITE GLOSS.

CHALLENGE CORN.

BRANTFORD RICE.

ELECTRIC STARCH.

**FINEST QUALITY.**

**NEATEST PACKAGES.**

**DEMAND CONSTANTLY INCREASING.**

**Brantford Starch Co.**

**BRANTFORD, ONT.**

## STARCH AND GLUCOSE.



### BENSON'S

**PREPARED CORN,  
ENAMEL STARCH,  
SILVER GLOSS AND  
SATIN STARCHES,**

ALSO . . .

**SUPERIOR GLUCOSE.**



MANUFACTURED ONLY BY

**THE EDWARDSBURG STARCH Co.,**  
CARDINAL, ONT.

SEND FOR PRICE LIST.

### Montreal

#### • Show Case Co.

A. T. EARL, Man. & Propr.

MANUFACTURERS OF

SHOW CASES

OF EVERY DESCRIPTION.

SEND FOR CATALOGUE . . .

750 & 752 Craig Street,

MONTREAL, Que.

G. H. BOULTON, Pres.

W. J. McCORMACK, Sec.-Treas.

TELEPHONE 1787.

### Toronto Cider and

#### •• Fruit Vinegar Co., Ltd.

MANUFACTURERS OF

**Pure Fruit and Malt Vinegar, Cider,  
Pickles, Sauces and Catsups,**

FACTORY: STOUFFVILLE, ONT.

OFFICE :  
22 FRANCIS STREET.

**TORONTO, Ont.**

# WM. BATEMAN & CO.

*MACHINISTS,*

... MANUFACTURERS OF ...

*Cloth Folding  
Machines.*



... ALL KINDS OF ...

*Mill Work.*

Also Tanners' and Curriers' Machinery.  
Re-sawing Band Saw Machines.  
Full Particulars given on application.

*53 St. Antoine Street,*

**MONTREAL, QUE.**

# A. & E. LOIGNON,

☼ *Civil Engineers* ☼

MANUFACTURERS OF ALL SORTS OF

## STRUCTURAL IRON WORK.

Architectural, Ornamental,  
Bridge and Builders' Iron Work.

• • •

WORKS: COR. ST. COLUMBAN & CANAL.  
(POINT ST. CHARLES.)

OFFICE: ROOM 27, 17 PLACE D'ARMES HILL,

**Montreal, Que.**

# J. K. MACDONALD

House & Steamboat Bell Hanger,  
Locksmith & General Blacksmith,

## MACHINIST,

ELECTRIC LIGHTING,  
ELECTRIC BELLS,  
WAREHOUSE TELEPHONES, ETC.

## BUILDERS' WORK

... A SPECIALTY ...

ARCHITECTURAL and ORNAMENTAL

## •• IRON WORK.

762 CRAIG STREET,

... MONTREAL.

# J. E. TOWNSHEND,

MANUFACTURER OF

WOVEN WIRE



## Spring Beds, Mantel Beds,

AND ALL KINDS OF

## Mattresses.



DEALER IN AND IMPORTER OF

BRASS AND IRON

## Bedsteads.

COR. ST. JAMES & LITTLE ST. ANTOINE STS.

**Montreal, Que.**

W. W. HANES, President. GEE. E. RICE, Vice-President.  
T. MCCREA, Sec.-Treasurer.  
A. E. MANSFIELD AND R. E. FLEMING, Directors.

## The McCrea-Hanes Co.,

(LIMITED.)

48 Richmond Street West,  
Toronto, Can.

Proprietors and Manufacturers of the following articles:

**McCrea's Inks**, non-corrosive and frost proof.  
**Egyptian Stove-pipe Enamel.**  
**Kitchen Queen Liquid Stove Polish,**  
**and Lustre.**

**Liquid Shoe Dressing.**

**Shoe Blackings and Tan Paste.**

**Vensoline and Tooth Powders.**

**Hood's Root Beer.**

**Flavoring Extracts,**

**Dyphtheria Conqueror,**

**Syrup of Tamarac Gum,**

**Pure Gum Mucilage, &c., &c.**

Quotations furnished the Trade on application with  
pleasure.

THE

## MASTER • MECHANICS' EXTRAORDINARY



# TAR.. SOAP

HALF-POUND CAKE FOR 10c.

Is a strong detergent, but positively makes the  
skin soft and pliable.

.. THE ..  
Albert Toilet Soap Co.  
MONTREAL.

**MAKE IT.**

ALL WHOLESALE  
DEALERS  
IN THE DOMINION.  
**SELL IT.**

## LANCASTER MACHINE WORKS.

.. MANUFACTURERS OF ..

CHEESE FACTORY, SAW MILL & TANNERS'  
**MACHINERY.**

Engines, Boilers, Pumps, Shafting, Wrought  
and Cast Iron Pulleys, Bakers' Revolving  
Ovens, Hydraulic Jacks, Copying Presses,  
Store and Church Seats, Bottle Corking  
Machines.

"LANCASTER" ENSILAGE  
FEED CUTTERS.

Specialty of Re-boring Engine Cylinders in  
their places. Estimates furnished for all classes  
of Founders' and Machinists' Work.

CORRESPONDENCE SOLICITED.

WM. STAFFORD, - Proprietor,  
LANCASTER, Ontario.

## CANADA BUNG & SPILE FACTORY,

ESTABLISHED 1875.

.. MAKERS OF ..

BASSWOOD, OAK AND PINE CUT

BUNGS and TAPS,  
SPRUCE TAPS (with the grain).

SPILES, all kinds.

BORED BUNGS, DECK-PLUGS, Pine or Oak.

PUTTY BUNGS,

DOWELS, MEAT SKEWERS.

SEND FOR PRICE LIST AND SAMPLES.

G. L. DICKINSON,  
MANOTICK, Ont., Canada.

## ANDREW YOUNG,



### MACHINIST AND ENGINEER

MANUFACTURER OF

Mill Work, Shafting, Pulleys, Hangers,  
General Machinery, &c.

11, 13 & 15 BUSBY LANE,

MONTREAL, Que.

The ONLY RELIABLE TRUSS in the World.

B. LINDMAN, MANUFACTURER,

ROSSIN BLOCK,

TORONTO, ONT.



SEND FOR CATALOGUE.

◆◆◆ The Canadian Office and School Furniture Company, Ltd.

◆◆◆ PRESTON, Ont., Nov. 26, 1894,

◆◆◆ BERNARD LINDMAN, Esq., Toronto.

◆◆◆ DEAR Sir,—It is now about 3 months ago since I first noticed that a cure of my rupture was being effected by the use of one of your Wilkinson Trusses, and now I am fully convinced that the cure is both complete and effectual. I have on several occasions within the last few weeks taken long walks without truss or support of any kind, and have every confidence that my rupture, which, as you are aware, was of a very severe description, is now permanently healed, and I can assure you that I feel deeply thankful for the beneficial results. I have already recommended your appliances to several of my friends similarly affected.

◆◆◆ Yours very sincerely,

◆◆◆ J. H. MICKLER, Supt.

**Paul Frind** 

**Woolen Machinery Co., Ltd.**

118 DUKE STREET,

... TORONTO. ...

**Woolen Machinery**

and

**Woolen Mill Supplies**

of every description for sale.

BEST ENGLISH CARD CLOTHING A SPECIALTY.

**WOOL—A large stock always on hand.**

SOLE AGENTS FOR FRANCIS WILLEY & CO., BRADFORD, ENG.

**BEAM WARPS.**

SOLE AGENTS FOR HAMILTON COTTON CO.

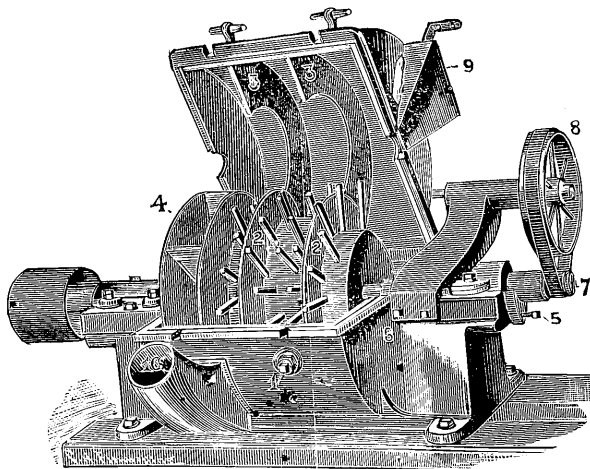

**E. S. Stephenson & Co.**

**ENGINEERS AND MACHINISTS,**

MAKERS OF THE

**WOODBURN**   
PATENT IMPROVED **PULVERIZER**

Reducing to an impalpable powder without SIFTING or BOLTING:

Sugar, Starch, Cream Tartar, Ginger, Cassia, Foundry Facings, Oxide of Iron, Carbon, Black Lead, and many other substances.

We also make Presses and Dies for Hand and Power and have special facilities for the manufacture and repair of all kinds of Machinery.

Office & Works: 17 & 19 Nelson St., **ST. JOHN, N.B.**

**Bain Bros. Mfg. Co., Limited,**

**BRANTFORD, ONT.**

NOW COMPRISING THE BUSINESSES OF

**THE BAIN WAGON CO., LTD. AND THE BAIN BROS. MFG. CO., LTD.**

WOODSTOCK, ONT.

BRANTFORD, ONT.

THE MOST EXTENSIVE MANUFACTURERS OF

CAST SKEIN or STEEL SKEIN . . . . . **WAGONS AND SLEIGHS,**

HOLLY PATENT LOW-DOWN WAGONS,

BETTENDORF ALL-STEEL GEARS.

Log Trucks, Dump Carts, Spring Lorries, Bob Sleighs, Wyeth & McCully Patent Runner Attachments, etc.

Illustrated Catalogue and Prices sent on application.

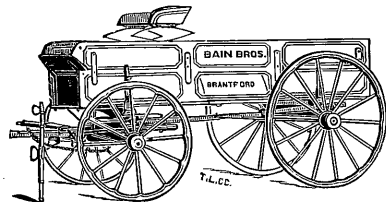

Please address to

Head Office: **BRANTFORD, Ont.**

St. Mary's Agricultural Works.

**DAVID MAXWELL & SONS,**

ST. MARYS, ONTARIO, CANADA,

Manufacturers of

Binders, Mowers, Reapers,  
Hay Loaders,  
Hay Tedders, Hay Rakes,  
Disc Harrows,  
Turnip Sowers, Scufflers,  
Root Pulpers and Slicers,  
Sulky Plows,  
Wheelbarrows, Churns,  
Lawn Mowers,  
Lawn Rollers, &c.



**AGENTS REQUIRED** in all Unoccupied Territory.

Write for Descriptive Pamphlet.

FOR

- Rotary Fulling Mills, . . .
- Cloth Washers, . . . . .
- Wool Pickers, . . . . .
- Rotary Force Pumps, . . .
- Friction Clutch Couplings,
- Hangers, Shafting, . . .
- Gearing, Forgings . . . . .

.. ALSO ..

Drag Sawing Machines  
Circular Sawing Machines,  
Horse Powers, &c.,

.. CALL ON OR WRITE ..

**YOUNG BROS.,**

...ALMONTE, Ont.

Reelthing of Garnett Machines a specialty.

Lowest Prices for Honest Goods.

**THE DICKSON COMPANY**  
**OF PETERBOROUGH. LTD.**

HEAD OFFICE: PETERBOROUGH, ONT.

MILLS SITUATED AT  
PETERBOROUGH, LAKEFIELD & HARWOOD (RICE LAKE.)

THOS GEO HAZLITT, Pres. and Man. Dir



THIS Company owns extensive water powers in the thriving town of Peterborough and are prepared to grant leases to manufacturers on the most liberal terms. They will either rent power alone, or factories with power combined. Railway sidings run from the C.P.R. and G.T.R., respectively to the Company's water privileges, which are most conveniently located near the centre of the town.

The Lakefield water power is one of the best and most convenient of the many valuable privileges on the Otonabee River. It is situated on the Trent Valley Canal at the outflow of the Katchewanooka Lake, and at the terminus of the Lakefield Line, a portion of the Midland system, where it forms connection for carrying freight with the Grand Trunk Railway, whose sidings run into the various mill yards located at Lakefield.

... CORRESPONDENCE SOLICITED.

**Brass, Steel and**  
**Rubber Stamp**  
MANUFACTURERS.

Railways' and Companies' Stamps and Seals.  
Medals for Schools and Societies,  
**METAL BADGES,**  
Trade Checks in Aluminum and Brass,  
Bank and Office Brass and WireWork.  
Stencil Plates, Steel Stamps

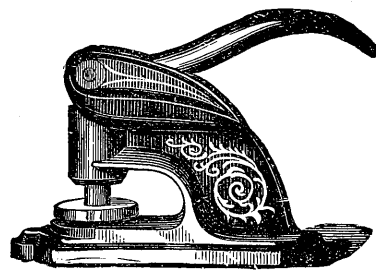

**Brass**  
**Signs.**

**PRITCHARD & ANDREWS,**

173 & 175 SPARKS ST., OTTAWA, ONT.



W. C. TROTTER, President. H. G. PERCHARD, Secretary.

Authorized Capital, \$500,000.00.  
Paid up " \$200,000.00.

**THE STANDARD  
DRAIN PIPE CO.**  
OF ST. JOHNS, P.Q., (LIMITED.)

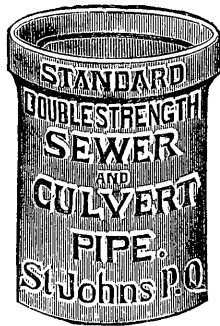

.. MANUFACTURERS OF ..

Salt Glazed Vitrified Drain Pipes and Connections, Double Strength Culvert Pipes, Inverts, Flue and Stove Linings, Gully Traps, and all kinds of Fire Clay Goods.

**BUTTON & FESSANT,**  
WINGHAM, ONT.

**SAW MILLERS,**

AND MANUFACTURERS OF

Wood, Cane, and Perforated Seat

✻ **Chairs.**

**BROOM HANDLES,  
MANGLE ROLLERS,  
ETC., ETC.**

**The Brantford  
Stoneware • Mfg. • Co.**

(LIMITED.)

**BRANTFORD, CAN.**

ESTABLISHED 1849. INCORPORATED 1894.  
MANUFACTURERS OF

EVERY DESCRIPTION OF

ROCKINGHAM, YELLOW,  
BRISTOL AND SALT-GLAZED.

**STONEWARE**

DOMESTIC, SANITARY, CHEMICAL  
AND ELECTRICAL.



Our Goods cannot be surpassed on the Continent for uniformity of Color, Superiority of Finish, and durability for all purposes.



DR. LOWREY, HENRY SCHULER, J. P. HEMPHILL,  
President. Manager. Sec. & Treas.

**R. DONALDSON & SON**

29 MCGILL STREET:

MONTREAL, Que.

MANUFACTURERS OF

**WIND MILLS**

For Pumping Water and Driving  
Farm Machinery . . . . .

**PUMPS, TANKS**

And everything in the Windmill line.

**GENERAL MACHINISTS,  
BUILDERS' IRONWORK,  
ETC., ETC.**

# Mining and Mill Machinery

Steam Engines, Rock Crushers, Boilers,  
Derricks, Steam Pumps, Water Wheels,  
Brass & Iron Castings of every description.

ALEX. FLECK, JR.

VULCAN IRON WORKS,

OTTAWA.

Stratford Bridge & Iron Works,  
STRATFORD, ONT.

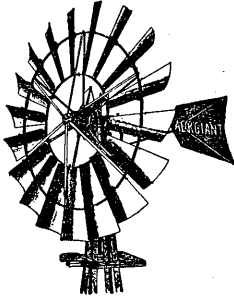

GALVANIZED STEEL  
WINDMILLS,  
... FOR ...  
PUMPING AND POWER.

Grain Grinders,  
Circular Wood Saws,  
Steel and Iron  
Highway Bridges.

MANSON CAMBELL,  
CHATHAM, Ontario,

MANUFACTURER OF

**Fanning Mills,**

WITH BAGGING ATTACHMENTS.  
50,000 now in use. 6,000 sold in 1894.

ALSO MANUFACTURER OF

Wire Cloth and Perforated Sheet Metals of all kinds,  
for Threshing Machines, Flour Mills, Oat Meal  
Mills, and all kinds of Grain Cleaning Screens.

CORRESPONDENCE SOLICITED.

WM. HOOD & SON,  
BUILDERS AND CONTRACTORS.

MANUFACTURERS OF

**Pile-Driving  
Machinery...**

SPECIALTIES:

 **Pile Driving AND  
Stone Quarrying.**

We are prepared to furnish from our own Quar-  
ries in New Brunswick,

BROWN AND OLIVE

**FREESTONE**

of the finest quality and of any dimensions. Full par-  
ticulars on Pile-Driving Work of all descriptions given  
on application and estimates furnished. Foreign cor-  
respondence carefully and promptly attended to.

10 RICHMOND SQ.

MONTREAL, Que.

**FRASER BROS.**

MACHINISTS, ENGINEERS,  
AND FOUNDERS,

**NEW GLASGOW, - Nova Scotia.**

Steam Engines, Shafting, Pulleys,  
Hangers, etc.

Gear Cutting in either Brass, Steel, or  
Cast Iron.

Hot Water Boilers, Pipe Fittings,  
Coil Stands, Coil Screening, etc.

Castings, Iron or Brass, of all kinds.

Bronze Tuyeres and Notches.

Gold Crushers, Steel Shoes and Dies.

Hard Cast Shoes and Dies.

**NEW GLASGOW, - NOVA SCOTIA.**

The most important feature in your plumbing is the water closet. If you want the Very Best, use the

D.S.P.Co. **"PRIMO"**  
**SYPHON JET,**  
*With Seat Attachments.*

**"RICHELIEU"**  
(REGISTERED)

... AND OTHER ...

HIGH CLASS CLOSETS, PLUG BASINS, HOPPERS, URINALS, &c.

Our goods are manufactured from prepared English Clay, and every piece sent out bears our Registered Trade Mark.

Correspondence solicited.

MONTREAL OFFICE AND SAMPLE ROOM:  
 68 TEMPLE BUILDING.

**Dominion Sanitary Pottery Co.,**  
**ST. JOHNS, QUE.**

**PADDON & NICOLSON,**  
**PRACTICAL SANITARIANS.**  
**THE CRESCENT ANTI-FREEZING SOIL PIPE TOP.**

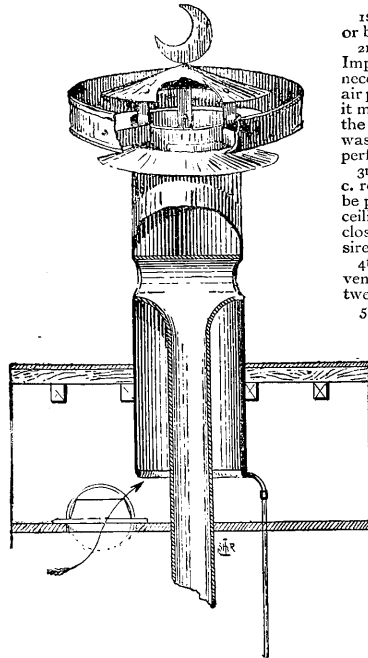

- 1st.—It will not freeze or become clogged.
- 2nd.—By using the Improved Top it is not necessary to run the back air pipe through the roof; it may be connected with the soil pipe above all waste connections with perfect safety.
- 3rd.—In ventilating v. c. rooms, a register may be placed in the wall or ceiling, which can be closed or opened as desired.
- 4th.—It is a means of ventilating the space between roof and ceiling.
- 5th.—By using our improved top there is only one pipe through roof instead of two or three as formerly.

It has been in use two winters and has been tested by Experts and we Guarantee it will not freeze at

**25° below Zero,**

See Certificate.

2686  
 St. Catherine St.,  
 MONTREAL.

# The Montreal Paper Co.

MILLS AT PORTNEUF.

MANUFACTURERS OF

**RED STAR BRAND .**

Tarred Felt,  
 Building Paper,  
 Sheating and  
 Carpet Felt,



Tarred Felt,  
 Roofing Felt,  
 Wrapping Felt, &c.



**PORTNEUF, Que.**

# J. O. Parker & Co.

**HOT WATER  
 TEA & COFFEE  
 URNS.**

MANUFACTURERS OF

Soda Water  
 Machinery,  
 Fire  
 Department  
 Brass Work  
 And . . .  
 Plumbers'  
 Supplies,

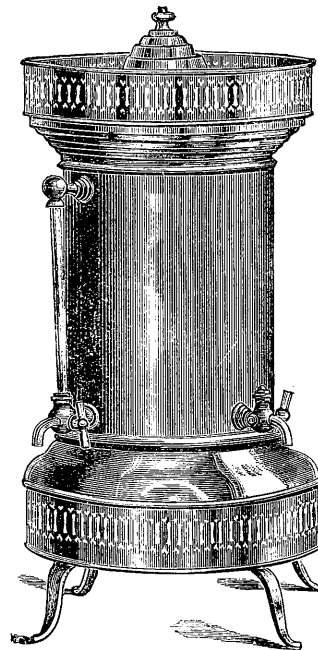

**TORONTO,  
 ONT.**

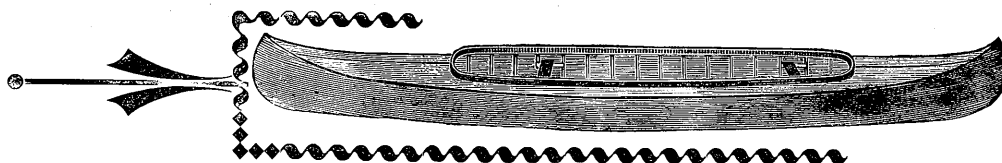

# THE GILBERT BOAT CO.,

.. MANUFACTURERS OF ..

*Padding and Sailing Canoes, Rowing and Sailing Skiffs,  
Cruisers, etc., etc,*

*Beautifully Finished. Finest Workmanship.  
Catalogues on application.*

**BROCKVILLE, ONT.**

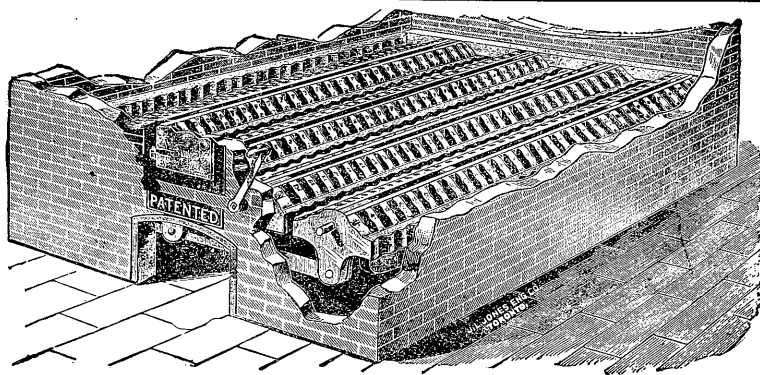

## The Heeson Rocking Grate Bar Co. OF TORONTO, LTD.

With the Heeson improved Rocking Grate the fireman can handle his fires with closed doors to a degree of perfection never before experienced, keeping them free of ashes and clinkers, every square inch doing good work, ensuring perfect combustion of coal and quick generation of steam. We guarantee 10 per cent. saving in fuel and burn screenings as well as large coal. Will place them in on trial, if not satisfactory no sale.

...Office: 108 Bay Street.

# Printers!

Newspaper Printers especially

## The Linotype

Will reduce your composition bill 60 per cent. after paying interest on your investment, depreciation and all expenses. More than 2,000 in use in North America, Great Britain and Australia. For full information, send copy of your paper and write to . . . . .

## Linotype Co.,

TEMPLE BUILDING,  
MONTREAL, Can.

# PETERBOROUGH ROLLER MILLS.

P. G. McCARGER, Propr,  
PETERBOROUGH, ONT.

## HIGH GRADE FAMILY FLOUR

Pastry and Strong Bakers,

SPECIAL BRANDS:

"SAMPSON," "MORNING STAR."

Good Shipping Facilities for  
Flour, Feed and Grain.

CORRESPONDENCE SOLICITED

**DO NOT DESTROY**

*your METAL DROSSES and TRIMMINGS, save them and write us for quotations.*

# SOLDER. BABBITT.

HALF AND HALF SOLDER,  
WIRE SOLDER,  
PLUMBERS' SOLDER,  
DROP SOLDER,

STEREOTYPE METAL,  
ELECTROTYPE METAL,  
BAR and PIG LEAD,  
ZINC SPELTER.

CANNERS' SOLDER A SPECIALTY,

# DROSSES.

*We have all kinds of Metal Drosses.*

*SPECIALTY—Manufacturers of all kinds of SOLDER and BABBITT for Electric Railways.*

**Toronto Smelting and Refining Works,**

Manufacturers of

**HERCULES METAL.**



FRANKEL BROS., Proprs.,

116-130 George Street,

CAELE ADDRESS: "WHITE," TRENTON.

**Polley & White,**  
Canadian  
Evaporated **APPLES**

.. DEALERS IN ..

DRIED APPLES.  
APPLES FOR EXPORT.

*Correspondence solicited.*

TRENTON, Ont., Can.

**PHOENIX FILE**  **WORKS**

FREDERICK BAUSCH, Propr.

**ANCHOR BRAND**  
**FILES AND RASPS.**

COTE ST. PAUL,

MONTREAL, Que.

ESTABLISHED 1834.

**SKINNER & CO.**

MANUFACTURERS OF

**SNATHS, CRADLES, SAW  
HANDLES, HAMES, AND  
SADDLERY HARDWARE**

OF ALL KINDS.

Carriage Dash Rails, Arm Rails, &c.

OF ALL SIZES.

Close Plating and Brass Casting

A SPECIALTY.

SEND FOR CATALOGUE AND PRICE LIST.

**GANANOQUE, - ONT,**

# MACDONALD & CO. LTD.

IMPORTERS OF

## Cast and Wrought Iron Pipe,

WITH FITTINGS OF EVERY DESCRIPTION.

... DEALERS IN ...

*Engineers' Supplies, Machinery, &c.*

— HALIFAX, N.S.

*Waring,*  
• *White & Co.,*

**ENGINEERS,**

 Marine and Mill Machinery,  
Iron and Brass Castings.

Prompt attention to Repairs.  
Correspondence Solicited.

DEEP WATER TERMINUS OF INTERCOLONIAL RY.,  
LOWER COVE,

— *ST. JOHN, N.B.*

**JAMES VANCE,**  
**HEPWORTH STATION, ONT.,**  
(CANADA.)

MANUFACTURER OF

SLACK BARREL

 **STAVES**  
AND ...  
**HEADING**

Sawn Lumber, Dressed Lumber,  
HARD AND SOFT,

Shingles, Lath, Fence Posts, &c.

• • •

Orders in Car Lots on G.T.R. given prompt attention.  
Correspondence Solicited.

The Young & Brother Co., Limited.

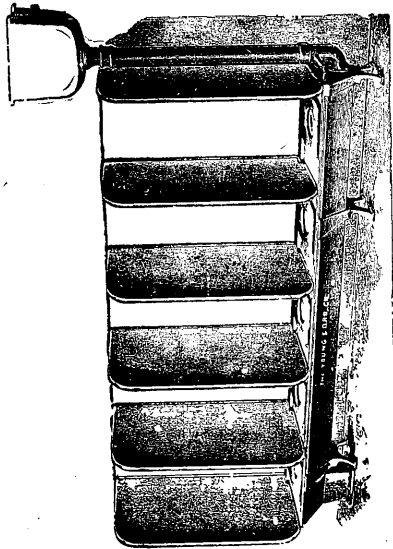

**Supplies**  
Plumbers', Steamfitters', Engineers'

Office & Warehouse: HAMILTON, Ont.  
Works: BRAMPTON, Ont.

**C. N. VROOM,**  
ST. STEPHEN, N.B.,  
... MANUFACTURER OF ...

Oil Tanned Larigans, Pacs and Moccasins  
FOR LUMBERMEN'S WINTER WEAR.

The Famous ...  
Waterproof Larigan Boot,  
With Riveted Seam,  
... A SPECIALTY.

**MCDONALD & ALLEN,**  
... MANUFACTURERS OF ...  
BRONZE AND PORCELAIN  
**DOOR KNOBS,  
PICTURE KNOBS,  
BELL PULLS, ETC.**  
KINGSTON, Ont,

**See** \_\_\_\_\_  
that you get value for your money.

◆ ◆ ◆  
**EAGLE** \_\_\_\_\_  
**BAKING POWDER**

CANNOT BE EXCELLED.

WRITE FOR SAMPLES.

The Eagle Baking Powder Co'y,  
LIMITED,  
396 St. Paul Street,  
T. B. MUNRO,  
MANAGER, **Montreal.**

**The Essex Brass & Iron Co., Ltd.**  
LONDON, Ont.

**Brass Castings**  
... Of all Kinds ...

Art and Ornamental Brass  
and Spun Metal Work . . . . .

TO ORDER.

Correspondence Solicited.

# MELDRUM & McALLISTER,

PETERBORO, ONT.

## AUBURN FLOUR AND OATMEAL MILLS

Capacity per day, 500 bbls. Flour; 200 bbls. Oatmeal, etc.

MANUFACTURERS OF \_\_\_\_\_

**MIKADO**—An 80 p. c. Patent from Selected White Winter and Manitoba Hard Wheat.

**DELIGHT**—A 90 “ “ “ “

**GLADIOLI**—A 60 p. c. Patent from Selected White Winter Wheat.

**FIVE THISTLES**—A 40 p. c. Patent from Hard Manitoba Wheat.

**PURE CREAM**—A 40 p. c. Patent from Hard Manitoba and Red Winter Wheat.

**SILVER LEAF**—Straight Roller.

... ALSO ...

Rolled Oats, Rolled Wheat, Rolled Pot and Pearl Barley, Split Peas and all classes of Feed.

**WE CAN FURNISH MIXED CARS OF ANYTHING A FLOUR OR FEED MERCHANT REQUIRES.**

## Geo. Gale & Sons

And DOMINION WORKS, Upper Dean St.,  
BIRMINGHAM, England

WATERVILLE. P.Q.

... MANUFACTURERS OF ...

## “NEW DOMINION” AND CUBAN WIRE MATTRESS

Oval Woven Wire Mattresses.

... ALSO, MANUFACTURERS OF ...

## Iron and Brass Bedsteads

AND MAKE A SPECIALTY OF

## Combination Iron Bedsteads

BOTH FOR PRIVATE AND INSTITUTION USE.

Hair and all kinds of Mattresses made.

Only the best Goods used.



W. H. NOLAN, MANAGER.

TELEPHONE 1596.

# The Canada Machinery Agency,

... DEALERS IN ...

## Steam Engines,

**BOILERS, PUMPS, IRON AND WOOD-WORKING MACHINERY.**

... REPRESENTING ...

ROBB ENGINEERING CO.,  
AMHERST, N.S.

Engines and Boilers, Saw Mill Machinery.

THE SNOW STEAM PUMP WORKS,  
BUFFALO, N.Y.

Steam Pumps.

JOHN BERTRAM & SONS,  
DUNDAS.

Iron Working Tools.

321 St. James Street,

BOSTON BLOWER CO.,  
BOSTON, MASS.

Manufacturers of Blowers and Exhausters,  
Dry Kilns, Heating Apparatus.

THE CANT BROS CO.,  
GALT, ONT.

Wood Working Tools,

DODGE WOOD SPLIT PULLEY CO.,

Wood Split Pulleys. TORONTO

Montreal, Que.

## Bee Keepers' Supplies.

**T. PHILLIPS & CO.,**  
ORILLIA, ONT.

ARE PREPARED TO FURNISH ALL THE LATEST

**IMPROVED APPARISTS' OUTFITS.**

SEND FOR CATALOGUE.

## OTTERVILLE MFG. CO.

Piano Stools in great variety.  
Moorish Fret Work and Grilles for  
House Decoration.

Easels, Screens, Carpet Sweepers,  
Step Ladders, &c.

All kinds of Wood Turnings to order.  
Corn Planters, Corn Shellers,  
Post Hold Diggers,  
Wire Stretchers, &c.

SEND FOR CATALOGUE.

OTTERVILLE, Ont.

## Pomade Vaseline.

The purest and best dressing for the hair ex-  
tant. It is elegant, healthful and clean,  
and prevents Dandruff.

## Vaseline Cold Cream.

Superior to all cosmetics or powders for the  
Skin and Complexion. For use after  
shaving it is unequalled.

## Vaseline Camphor Ice

For Chapped Hands, Lips, Pimples, Blotches,  
and Local Irritations.

◆ ◆ ◆  
**Chesebrough Manf'g Co'y,**

(CONSOLIDATED.)

NEW YORK. LONDON. PARIS.

Canada Branch: 83 St. James St., MONTREAL.

# The John Morrow Machine Screw Co.

MANUFACTURERS OF . . .

SET  
CAP and  
SPECIAL  
SCREWS  
STUDS  
ROLLS  
Etc.

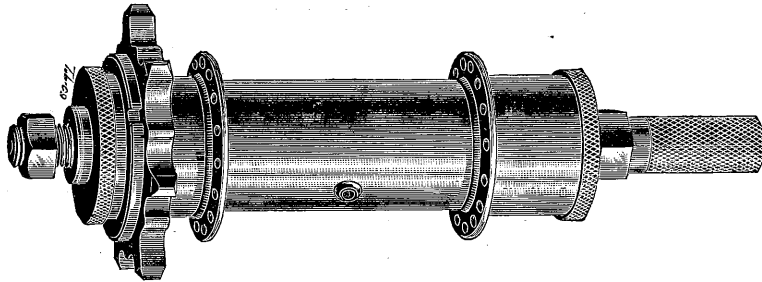

BICYCLE  
HUBS  
CORES  
CASES  
AXLES  
NIPPLES  
BOLTS  
NUTS, Etc.

Electrical and Bicycle  
Work a Specialty = =

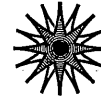

INGERSOLL, ONT.

THE

## CANADIAN MANUFACTURER

*Devoted to the Manufacturing Interests of Canada.*

Is the only Trade Journal published in the country reaching all classes of Manufacturers.  
Has the largest circulation of any Canadian Trade Journal.

*It reaches all the*



Blast Furnaces, Iron Works, Rolling Mills, Electric Light Plants and Manufacturers of Electric Machinery and Appliances. All the Cotton, Woolen and Carpet Factories and Yarn Mills. All the Manufacturers of Iron and Wood-working machinery; Manufacturers of Steam Engines and Boilers; Pumping and Mining Machinery, etc.

PUBLISHED ON THE FIRST AND THIRD FRIDAYS OF EACH MONTH.

J. J. CASSIDEY, Editor.

J. C. GARDNER, Business Manager.

Subscription \$1.00 per year.

ADVERTISING RATES ON APPLICATION,

The Canadian Manufacturer Publishing Company, Ltd.,

Room 66, Canada Life Bldg., King St. West,

TORONTO, CAN.

BRIGHT! NEWSY! INDEPENDENT!

# The Sun!

2 EIGHT PAGE EDITIONS DAILY BELLEVILLE.  
12-PAGE WEEKLY

Covers Midland Ontario!

## THE BERLIN RECORD

(Daily and Weekly)

Is acknowledged to be the best advertising medium in Waterloo County, as it indisputably is the leading newspaper. The **Daily Record** is the paper of a large and progressive manufacturing town. The people who read it are well-to-do German Canadians who have money to spend.

W. V. UTTLEY, Business Manager. BERLIN, ONT.

## THE BRANTFORD EXPOSITOR

DAILY AND  
WEEKLY

Published in one of the finest Agricultural and Manufacturing sections of Canada. Circulates widely amongst the best classes. Is the Leading paper in Brant district and occupies one of the finest newspaper houses in Ontario.

Rates on Application.

T. H. PRESTON,  
Editor and Publisher.

## THE CORNWALL STANDARD

CORNWALL, ONT.

Circulation more than double that of any other paper published in Stormont, Dundas and Glengarry.

Advertising Rates and Sample copy furnished on application.

DAILY.

WEEKLY.

## THE REFORMER

Is the leading newspaper in the town of Galt or in Waterloo County. Circulation double that of any other paper in the County. Advertising rates reasonable.

ANDREW LAIDLAW, Publisher and Proprietor.

## The Herald

Published at  
Hamilton, Canada.

Circulation Average, 10,000.

SUBSCRIPTION, \$3.00 PER YEAR

Hamilton's Pioneer one cent paper.

8 Pages

## THE TIMES

HAMILTON, ONT.

A bright live newspaper and one of the leading journals in Canada.

When advertising use THE TIMES,

Daily, \$3.00 per annum.

Weekly, \$1.00 per annum.

ESTABLISHED AUGUST 1853.

## THE CHRONICLE

and Canadian Dairyman,  
INGERSOLL, ONT.

Largest circulation and best advertising medium in the South Riding of Oxford.

CHRONICLE PRINTING CO.,

\$1.00 PER YEAR.

Proprietors.

Established 1854.

## THE CANADIAN POST

DAILY AND WEEKLY. LINDSAY, ONT.

Circulating in the best farming District in the Province.  
"One of the first weekly Papers in Canada."—*Toronto Globe*.

WILSON &amp; WILSON, Publishers.

## The Victoria Warder

LINDSAY, ONT.

SAM HUGHES, Editor and Publisher.

## THE DAILY ADVERTISER

 Two Editions Daily.

Recognized leading Daily of Western Ontario. Read by Merchants, Mechanics and the people generally.

## THE WESTERN ADVERTISER

 Weekly Edition.

Largest circulation in Western Ontario. Has no rival as an advertising medium. Sixteen Pages.

Job Printing of all kinds. Agents for Calvert Litho. Co., Detroit, for Dominion of Canada. Rates on application.

JOHN CAMERON, ADVERTISER PRINTING CO.,  
President and Manager. LONDON, ONT.

## THE PEMBROKE STANDARD

PEMBROKE, ONT.

One of the best advertising mediums in the Ottawa Valley—especially for those desiring to reach Lumbermen and saw-mill owners.

BONE & ROSS,  
Proprietors.

## THE PETERBOROUGH "EXAMINER"

DAILY AND WEEKLY.

Peterborough's Leading Papers.

Largest circulation consequently best advertising medium.

THE EXAMINER COMPANY,  
J. R. STRATTON, Pres.

### ADVERTISEMENTS IN

## THE ST. MARYS ARGUS

are Read.

Good Home Newspaper.

W. K. MacLEOD, Publisher,

ST. MARYS, ONT.

2 Great  
Facts25th year . . . .  
of Publication

The religious press pays advertisers

## THE CANADA PRESBYTERIAN

Leads the Religious press of this Church in the Dominion.

CANADA PRESBYTERIAN, 5 Jordan St., TORONTO.

Live Avertisers . . . . .

## Use THE EVENING NEWS

The largest bona fide circulation of any Daily paper published in the Province of Ontario, viz: over 30,000 copies per day. Contracts made on this basis. Write us for rates.

WM. DOUGLAS,

THE NEWS, 108 Young St., TORONTO.

## THE TORONTO DAILY STAR

Is a Bright Newsy Paper.

Winning its way rapidly in popular favor by its **up-to-date methods** Through independence on all questions. Unobjectionable reading matter.

Making it a safe paper for the home, and a good one for advertisers who aim at reaching the best class of people.

114 Young Street, TORONTO, Can.

## THE MONETARY TIMES

Has the best Advertisers, the best readers and many of them . . . . .

It is published in

TORONTO.

## THE ADVOCATE

TRENTON, ONT.

GEO. A. GRAHAM, Publisher.

One of the brightest, newest papers in Hastings County. A valuable advertising medium to reach the well to do people of this thrifty district.

ESTABLISHED 1805. Subscription: \$3 per annum.

## The "Quebec Daily Mercury,"

WILLIAM J. MAGUIRE Proprietor,

20 and 22 Mountain Hill, QUEBEC. Telephone 701.

Best advertising medium in the Province outside of Montreal.

Advertising rates, 10 cents per line for first insertion and 5 cents for subsequent. Big discount to contract advertisers.

One cent per copy. Subscription: \$3. per annum

## L'Événement

THREE EDITIONS A DAY.

The best medium for advertisements in Quebec.

Circulation larger than all other papers published in Quebec and Levis.

L. J. DEMERS & FRERE, Proprietors.

## The Stanstead Journal

Published every Thursday,

AT ROCK ISLAND, COUNTY OF STANSTEAD.

Has a circulation of 1500, principally in Stanstead County, an excellent medium for advertisers.

Terms: \$1.00 in advance.

## Le Canada Français

and the FRANCO-CANADIEN

Established in 1860.

Only French paper edited at ST. JOHNS, P.Q., Can.

Circulation, 3,000.

## "THE SHERBROOKE EXAMINER"

Published weekly by

W. A. MOREHOUSE & CO.

A most desirable medium for advertisers. \$1.00 a year.

Job Printing of all kinds done neatly and promptly.

## Sherbrooke Gazette

EVERY FRIDAY.

The Gazette has a growing subscription list amongst the best farmers of "The Garden of Canada."

Advertising rates fair considering the service given.

## THE GLEANER

FREDERICTON, N. B.

Is the largest circulating medium in Central New Brunswick.

DAILY AND WEEKLY EDITIONS.

## THE MONCTON TRANSCRIPT

DAILY AND WEEKLY.

JOHN T. HAWKE, Editor and Proprietor, MONCTON, N.B.

LIBERAL IN POLITICS.

Best advertising medium in Westmorland, Albert and adjacent Counties of New Brunswick and Nova Scotia. Write for rates.

## ST. JOHN DAILY SUN

8 Pages.

## ST. JOHN WEEKLY SUN

16 Pages.

Are the leadings papers in Maritime Provinces.

Sworn Circulation.

Established 1862.

## DAILY AND WEEKLY TELEGRAPH

ST. JOHN, N.B.

Leading Journal in Maritime Provinces. The circulation of the respective Daily and Weekly editions is **Confessed to be Much Greater** than that of the corresponding editions of any other Paper published in the Dominion, East of Montreal.

## THE CARLETON SENTINEL

WOODSTOCK, N.B.

S. & J. WATTS, Editors and Publishers.

Oldest paper in New Brunswick. A live family newspaper. Circulates among an intelligent and wealthy agricultural class. Best advertising medium of any county weekly in the Province.

\$1.00 per year.

Circulation, \$2,100.

## THE TIMES YARMOUTH.

Is the Advertising Medium

IN WESTERN NOVA SCOTIA.

Ask The Advertising Agents.

## The Buyers and Sellers Guide

OF CANADA 1895-6.

This copy cost the owner \$5.00, only the man of **cheek** will ask the loan of it.

THE MANUFACTURERS LIST CO., Montreal.

**ARLINGTON HOTEL,***A. MATHESON, Manager,***TILSONBURG, Ont.**NEW, HOT AIR, CUISINE OF THE BEST.  
NEW SAMPLE ROOMS, BUS TO ALL TRAINS.**THE BATTERSBY HOUSE,***W. D. BATTERSBY, Manager.***SIMCOE, Ont.****THE BRUNSWICK HOUSE,***J. D. DULMAGE, Proprietor.***... WINGHAM, Ont.****CAMPBELL, HOUSE,***H. G. MILLING, Proprietor,***... NAPANEE, Ont.**Bus to and from all Trains and Boats. First Class Sample Rooms.  
Billiard and Bath Rooms. Telegraph and Telephone connections.  
Barber Shop.**COMMERCIAL HOTEL,***HARRY MAXEY, Proprietor.***HAMILTON, Canada.**

TELEPHONE 104.

**GRAND UNION HOTEL,***ALEXANDER & DANIELS, Proprietors,***OTTAWA, Ont.****HOTEL DUFFERIN,***SCHULTZ & GORDON, Proprietors,***WINDSOR, Nova Scotia.**

Commercial Travellers, Tourists, and Visitors to the Maritime Provinces, stopping at Windsor, will find this Hotel offers superior advantages, being centrally located, and in close proximity to Railway Depot and Public Buildings.

**GOOD SAMPLE ROOMS IN CONNECTION.****HOTEL DEL MONTE,****PRESTON, Ontario.**

MINERAL SPRINGS AND BATHS.

THE COMMERCIAL HOTEL OF GRIMSBY. TERMS: \$1 PER DAY.

**THE LINCOLN HOUSE,***G. F. MAREY, Proprietor.***GRIMSBY, Ont.**

CHOICE LIQUORS.

BEST BRANDS OF CIGARS,

**MISSISSIPPI HOTEL,***W. McILQUHAM, Proprietor.***CARLETON PLACE, Ont.****THE ORIENTAL HOTEL,***GRAHAM BROS., Proprietors.***PETERBOROUGH, Ont.**

First Class in every respect, Fare \$1.50 per day, Free 'Bus, Sample Room; with Baggage taken to and from Station, 50c. extra.

**PATERSON HOUSE,***W. M. MATTHEWS.***OWEN SOUND, Ont.**

STRICTLY FIRST CLASS.

THE LEADING HOTEL IN TRURO. FREE COACH ATTENDS TRAINS.

**THE PRINCE OF WALES HOTEL,***A. L. McKENZIE, Proprietor,***TRURO, Nova Scotia**Cuisine of the Finest. Good Sample Rooms.  
Beautiful Situation opposite Victoria Square.**QUEEN'S HOTEL,***GEO. FILLIAX, Proprietor,***LISTOWEL, Ontario.**

GOOD LIVERY ATTACHED.

**QUEEN HOTEL,***P. P. ARCHIBALD, Proprietor,***CHARLOTTETOWN, P.E.I.**

THE COMMERCIAL TRAVELERS' HOME.

**REID HOUSE,***VAL. KIRCHNER, Proprietor,***HANOVER, Ont.**

Bus to and from all Trains, Telephone connection, Enlarged and Remodeled throughout, Purest Liquors and Finest Brands of Cigars always on hand, attentive Hostler and best Stable accommodation.

**ST. LAWRENCE HALL,***A. ROBINSON, Proprietor,***BROCKVILLE, Ont.**

ACCOMMODATION FOR 200 GUESTS.

**THE QUEEN'S,***J. KEARNS, Proprietor,***PALMERSTON, Ont.**

# IMPORTERS.



## **BENSON, W. T. & CO.,**

**31 Common St., MONTREAL.**

Importers of Foreign Wools, Chemicals, Dye Stuffs, etc.

## **BELLHOUSE, DILLON & CO.,**

(J. ST. J. DILLON. R. LACY DILLON.)

**30 St. Frs. Xavier St., MONTREAL.**

Importers of Chemicals and Drugs.

## **BICKELL & WICKETT,**

**55 Front St. East, TORONTO.**

Importers of Degras, Cod Oil, Gambier, etc., etc.; manufacturers of Colored Pocket Book, Satchel, Bag, Valise and Staple Leathers; dealers in Hides, Oils, Tallow, Degras, Gambier, etc.

## **BISHOP, GEORGE H.,**

**308 Board of Trade, MONTREAL,**

Agent for Hudson, Sykes & Bousfield, Woollen Manufacturers, Leeds; also agents for manufacturers of Serges, Linings, Tweeds, Linen, Dress Goods, Print and Flannel Goods.

## **BREMNER, ALEX.,**

**50 Bleury St., MONTREAL.**

Importer of Drain Pipes, Cements, Water Lime, Fire Bricks, Fire Clay, Crucibles, Enamelled Sinks, Wheelbarrows, etc.

## **BUSHNELL Co., Ltd. (THE),**

**Board of Trade Bldg., MONTREAL.**

American Illuminating Oils, Napthas and Gasoline; Cylinder, Engine and Machine Oils.

## **CAVANAGH, (THE) EDWARD CO.,**

**2547 to 2553 Notre Dame St.,**

**MONTREAL.**

Importers Hardware, Oils, Paints, Coal, etc.

## **CHAPLEAU, G.,**

**412 St. Lawrence St., MONTREAL.**

Manufacturer of Fire and Burglar Proof Safes, Iron Vaults, Doors, Shutters, etc., and Importer.

## **COPLAND & CO.,**

**230 St. James St., MONTREAL.**

Manufacturers' Agents and Importers; Glass, Coal, Fire Clay Goods, Meters, Building Stone, Chemicals, Hats & Caps, French Goods, etc.

## **CORBY, H., Belleville, Ont.**

Distiller and Importer of Fine Wines and Liquors; Agent for Thos. Hine & Co., Jarnac, Cognac; J. & J. Vickers, Tom Gin, London, Eng. (Distillers to the Queen), V. Brille, Segonzac; British Guinea Distillery Co., Demerara; Williams Humbert & Co., Jerez De la Frontera Sherries; Messrs. Warre & Co., Oporto, Ports; Messrs. Warre & Co., Tarragona, Tarragonas; I. Gummeson & Co., Stockholm, Sweden, Arrac Punch; J. Brown & Co., London, Glasgow, Leith and Belfast, Irish and Scotch Whiskies.

## **CORMIER, Z. P., Sherbrooke, Que.**

Dealer in and Manufacturer of Hats, Caps and Furs.  
Importer and Shipper of Furs and Skins.

## **DEWDNEY, A. H. & BRO.,**

**44 Colborne St. East, Toronto,**

Manufacturers of Silver Wire, Solders, etc., for Surgical and Mechanical Purposes.

## **DOUGLAS, J. M. & CO.,**

**311 Board of Trade, MONTREAL.**

Representing:—Lea & Perrins, Worcester Sauce; Jas. Keiller & Son, Ltd., Marmalade, etc.; John Dewar & Sons, Ltd., Scotch Whiskey; Feuerherd Bros. & Co., Ports; Jose Pearnin & Co., Sherries; Robt. Macandrew & Co., London and Smyrna.  
Consignments solicited.

## **EVANS AND SONS, Ltd.,**

**37 to 45 St. Jean Bte. St., Montreal.**

Wholesale Druggists and Manufacturing Chemists.  
Importers of Foreign Drugs and Druggists' Sundries, etc.

## **FLEMING, W A.,**

**57 St. Frs. Xavier St., MONTREAL,**

Representing:—F. Reddaway & Co., of Manchester, Eng., manufacturers of Camel Hair Belting, Linen Hose, Stitched Cotton Belting, etc.

## **FOISY, (THE) THOS F. G. PIANO MFG. CO.**

**MONTREAL, Que.**

## **FORMAN, JOHN,**

**650 Craig St., MONTREAL,**

Importers of Electrical Supplies of all sorts.

## **FRASER, ROBERT S., Montreal,**

Importers of Wools, Cottons, Wastes, etc.

**HODGSON, SUMNER & CO.,**

347 &amp; 349 St. Paul St., MONTREAL,

Importers of British, French, German and American Dry Goods, Small Wares and Fancy Goods.

**HUDON HEBERT & CIE.,**

41 St. Sulpice &amp; 22 DeBresoles Sts.,

MONTREAL, Canada,

Wholesale Grocers and Wine Merchants.

**HUTTON, JAMES & CO.,**

15 St. Helen Street, MONTREAL,

Agents for Iron, Steel and Hardware.

**HYDE, FRANCIS & CO.,**

30 Wellington St., MONTREAL,

Importers of Scotch Drain Pipes, London Cements, Floor Tiles, Scoria Paving Blocks.

**LAPORTE, MARTIN & CO.,**

72 to 78 St. Peter St., MONTREAL,

Importers of Teas, Wines, Liquors, Provisions, Fruits, etc.

**LESLIE, A. C. & CO.,**

445 &amp; 447 St. Paul St., MONTREAL,

Iron, Steel, Tin Plate, Wire, Galvanized Iron, Cutlery, etc.

**MACFARLANE, J. DUNCAN & CO.,**

180 St. James St., MONTREAL,

Manufacturers' Agents.

**McINTYRE, C. J. & CO.,**

(C. J. McINTYRE.)

321 to 327 St. Paul St., MONTREAL,

Importers of Dry Goods and Small Wares.

**MONTREAL PRINTERS' SUPPLY  
AGENCY,**

Perrault Building, 73 St. James St.,

MONTREAL.

Importers of Printers' Supplies.

**MONTREAL STENCIL WORKS,**

S. A. FERNEYHOUGH, PROPR.,

219 McGill St., MONTREAL.

**MORIN, A. O. & CO.,**

73 St. Peter St., Board of Trade Bldg.,

MONTREAL,

Importers of Dry Goods Specialties.

**MUNDERLOH & CO., Montreal.**

Importers of Plate and Window Glass, Bottlers' Supplies, Bottles, Glassware, Syphons, Demijohns.

Sole Agents A. E. G. Incandescent Lamps.

**NELSON, H. A. & SONS,**

59 to 63 St. Peter St., MONTREAL,

Importers of Fancy Goods and Toys.

**NOWELL, B. L. & CO.,**

623 Lagachetiere St., MONTREAL,

Exporters of Fertilizers and Fertilizing Materials.  
Importers of Royal Cement Plaster.**PYKE, JAS. W. & CO.,**

35 St. Frs. Xavier St., MONTREAL,

Iron and Steel Merchants.

Representing Fried Krupp, of Essen, Germany.

**ROSE J. MACKAY,**

456 St. Paul St., MONTREAL,

Manufacturers' Agent. Silverware, Cutlery, Hardware Sundries, etc.

**TELLIER, ROTHWELL & CO.,**

8 De Bresoles and 35 Le Royer Sts.,

MONTREAL,

Importers of Dyes, Tin Foil, Essential Oils, etc.

**THIBAudeau, BROS. & CO.,**

332 St. Paul and 163 Commissioners Sts.,

MONTREAL,

Wholesale Dry Goods Importers.

**THORPE, GEORGE A. & CO.,**

25 Melinda St., TORONTO, Can.

Importers and Jobbers of Dry Goods, Woollens, etc.

**WIGHTMAN SPORTING GOODS  
COMPANY,**

(A. R. WIGHTMAN.)

403 St. Paul St., MONTREAL,

Importer of Fishing Tackle and Small Wares.

**WILSON, PATERSON & CO.,**

MONTREAL,

Importers of Chemicals, Oils, etc.

# H. McLAREN & Co.

## AGENTS,

706 = CRAIG STREET, = 706

Montreal.



General Agents in Canada  
for

Magnolia Metal Co.,

Of New York, Chicago and London.



N.Y. Aluminum Bearing Metal Co.

All Grades of Babbit Metals.

Best Value of any manufactured.



Henderson & Glass,

LIVERPOOL, ENGLAND,

Tin Plate and General Metal Merchants.

Bar Iron, Steel Plates, Sheets and Bars.

Structural Iron and Steel.



The Kingsley Steam Boiler,

The most economical of Space & Fuel.  
Competition defied.

# ROBERT & COMPANY, MONTREAL.

IMPORTERS OF Textile Mill Supplies, . . . . .  
Anilined Colors, Dye Stuffs, etc.

Sole Agents for Jno. R. Geigy & Co.,  
BASLE SWITZERLAND.

Fast Wool Colors. Extract of Sumac,  
Fast one Dip Cotton Dyes.  
Nutmall, Persian Berries, etc., etc.

Mail orders given prompt attention. Correspondence solicited.

# The Dominion Foundry Supply Co.,

MANUFACTURERS AND IMPORTERS OF

ALL FOUNDRY REQUISITES

\* Plumbago, Foundry Facings  
and Supplies . . . . .

43 St. Sacrament St., MONTREAL.

THOS. FORRESTER, SOLE AGENT FOR  
MONTREAL. Dick's Patent Balata Belting  
And dealer in Belting, Hose, Pullys, Rubber and Gutta Percha Goods, Rope,  
Pipe, Boiler Covering, Laco Leather, Asbestos, Oils, Grease Etc.

D. RATTRAY & SON, IMPORTERS OF  
WAREHOUSEMEN AND Grocers' Sundries, Etc.  
GENERAL COMMISSION MERCHANTS. QUEBEC, Can.

Robert Henderson & Co., Dry Goods,  
COMMISSION MERCHANTS, Montreal.

WATTERSON & AULDJO, MONTREAL.  
Tin and Canada Plates, Medals, etc.  
CHEMICALS, OILS, ETC.

ALBION HOTEL, KINNE & PEAVY,  
Proprietors.

The Hotel has lately been refitted and put in first-class order.  
Electric bells in every room.

The Table is unexcelled by any \$2.00 per day house in Canada.

Rates: \$1.50 to \$2.00 per day.

E. C. VAREY,  
Chief Clerk.

When in MONTREAL

STAY AT THE

ST. LAWRENCE HALL

The most centrally located and liberally managed hotel in the city.  
Strictly first class in every department.

HENRY HOGAN, PROPRIETOR.



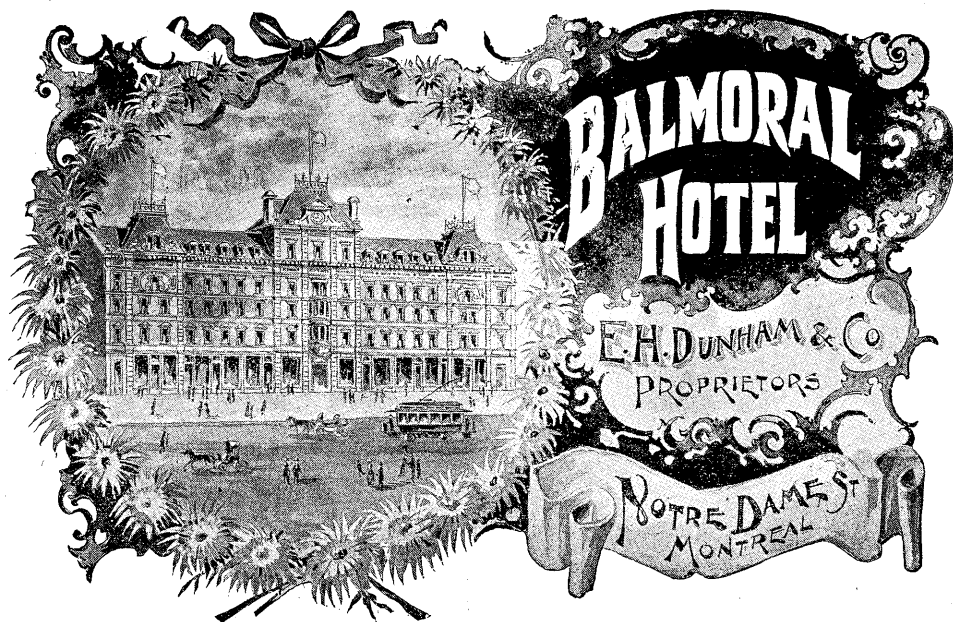

**ARLINGTON HOTEL**

WIARTON, ONT.

Headquarters for **COMMERCIAL TRAVELLERS**

J. JOHNS, Proprietor. *Cuisine of the best.*

**HERMANN HOUSE**

HEPWORTH, ONT.

M. A. HERMANN, - - - Proprietor.

Hotel is new. All modern improvements. First class Sample Rooms. Livery, etc. Bus at all trains.

**HOTEL BRUNSWICK**

GEO. McSWEENEY,

Proprietor.

MONCTON,  
N.B.

**QUEEN'S HOTEL..**

CORNER WINDSOR & ST. JAMES STS.  
MONTREAL.

Only fire-proof Hotel in Canada.  
Rates \$2.50 to \$3.00. Special rates Commercial Travellers and Permanent Boarders . . . . .

Manager:  
B. G. FRASER-CRIERIE.

**WAVERLEY HOUSE**

CENTRALLY LOCATED

Special rates to Theatrical Troupes, Commercial Men and Tourists . . . . . 738, 740, 742 LaGauchetiere St. and Victoria Square . . . . .

W. BOGIE PROPRIETOR. **MONTREAL.**

**QUEEN'S HOTEL**

PORT HOPE, ONT.

A. A. ADAMS, - - - PROPRIETOR

Headquarters for American travel via LAKE STEAMERS. CARRIAGES AT ALL TRAINS AND BOATS. . . . .

**RIENDEAU HOTEL..**

OPPOSITE COURT HOUSE AND CITY HALL  
58 & 60 JACQUES-CARTIER SQUARE

MONTREAL

TELEGRAPH OFFICE IN THE HOUSE.

**TERRACE HOTEL**

AMHERST,  
N.S.

\$1.50 to \$2.00 Wm. G. CALHOUN, Proprietor.

**THOMPSON HOUSE**

KING ST. 3 DOORS EAST OF RICHMOND ST.  
LONDON, ONT.

JOHN FRASER, Prop.

# General List of Canadian Manufacturers.

COMPRISING

Boot and Shoe, Cotton Goods, Flour, Feed and Meal, Iron Working, Leather, Lumber, Paper and Pulp,  
Stove and Implement Castings, Wood Working, Woollen Goods.

Alphabetically arranged for addressing purposes only under sub-headings:

## MANUFACTURERS.—Boot and Shoe.

Adams Shoe Co., Quebec, Que.  
Ames-Holden Co., of Montreal, Ltd.,  
[(The) Montreal, Que.  
Amherst Boot & Shoe Mfg. Co.,  
[Amherst, N.S.  
Archibald, F. H., Harbor Grace,  
[N.F.  
Bell, J. & T., Montreal, Que.  
Berrouard, Francois, Quebec, Que.  
Bilodeau, L., Quebec, Que.  
Boivin Fils, & Cie, Quebec, Que.  
Botterell, J. H., & Co., Quebec, Que.  
Bouchard, V. P., Montreal, Que.  
Boulet, J. S., & Co., Joliette, Que.  
Boyer, Geo. W., Victoria Corner, N.B.  
Brouillet, G., Montreal, Que.  
Brown, William, Montreal, Que.  
Chamberland & Co., Joliette, Que.  
Charron, Charles, Montreal, Que.  
Cloutier, A., & Co., Montreal, Que.  
Cochrane, Cassils & Co., Montreal, Q.  
Corbeil, A., Montreal, Que.  
Cote, J. A. & M., St. Hyacinthe, Que.  
Crosby, H. H., Co., (The) Hebron,  
[N.S.  
Dack, R., & Son, Toronto, Ont.  
Dayfoot, C. B., J Co., Georgetown,  
[Ont.  
Desautels, A., & Co., Montreal, Que.  
Dominion Shoe Co., Quebec, Que.  
Duchaine, T., Quebec, Que.  
Dufresne, D., & Co., Montreal, Que.  
Dugal, A. L. G., Quebec, Que.  
Dupont, Nap., & Co., Montreal, Que.  
Fluet, Joseph, Montreal, Que.  
Forgarty & Bro., Montreal, Que.  
Foster, A. T., & Co., Rock Island, Q.  
Gagnon & Vaillancourt, Montreal, Q.  
Galarneau, Louis, Montreal, Que.  
Gaudet, A., & Co., Montreal, Que.  
Geoffrion, Theophile, & Co., Mont-  
[real, Que.  
Gow & Wilson, Hamilton, Ont.  
Griffith, H., Quebec, Que.  
Grosch, C. S., Milverton, Ont.  
Hamilton, W. B., Son & Co.,  
[Toronto, Ont.  
Harrison, C., Pictou, N.S.  
Hemond, J. C., & Co., Montreal, Que.  
Hepburn & Co., Preston, Ont.  
Hetu, J. B., Montreal, Que.  
Hurley, James T., St. John, N.B.  
Jobin & Rochette, Quebec, Que.  
Jondro, Wm., Rock Island, Que.  
Julien, Edmond, Hedleyville, Que.

Kieffer Bros., Montreal, Que.  
King, J. D., Co., (The) Levis, Que.  
King, J. D., Co., Ltd., (The)  
[Toronto, Ont.  
Laidlaw, Watson & Co., London, O.  
Langlois, J. S., & Co., Quebec, Que.  
Laniel & Co., Montreal, Que.  
Lapierre, D., Montreal, Que.  
Lapierre, Z., & Fils, Montreal, Que.  
Larochelle, J. H., Quebec, Que.  
Lefebvre Freres, Montreal, Que.  
Linton, James, & Co., Montreal, Que.  
Marsh, W. A., & Co., Montreal, Que.  
Massicotte, Marie Louise, & Co.,  
[Montreal, Que.  
McCready, James, & Co., Montreal,  
[Que.  
McKeen & Polley, Quebec, Que.  
McPherson, J., & Co., Hamilton, Ont.  
Michaud, Lefebvre, & Co., Montreal,  
[Que.  
Migner, A., Boucher, & Co., Quebec,  
[Que.  
Migner & Goulet, Quebec, Que.  
Morrier, Bergeron & Co., Montreal,  
[Que.  
Oberholtzer, G. V., Berlin, Ont.  
Papin, J., Contrecoeur, Que.  
Parquette, H., Ottawa, Ont.  
Patten & Co., Hebron, N.S.  
Patten, Wm. H., Hebron, N.S.  
Pellerin, J. I., & Fils, Montreal, Que.  
Pellerin & Dufresne, Montreal, Que.  
Peltier, J. L., Montreal, Que.  
Pictou Boot & Shoe Co., Pictou, N.S.  
Poirier, J., Quebec, Que.  
Polley, W. H., & Son, Quebec, Que.  
Porter, Henry, & Co., Montreal, Qu.  
Redding, W. H., Yarmouth, N.S.  
Redding, W. H., & Co., Yarmouth,  
[N.S.  
Renault, Geo., Montreal, Que.  
Ritchie, John, Quebec, Que.  
Rochette, Dion, & Co., Quebec, Que.  
Schryburst, F., & Co., Quebec, Que.  
Seguin, Lalime, & Co., St. Hyacinthe,  
[Que.  
Silver, Wm., & Co., Sorel, Que.  
Slater, Geo. T., & Sons, Montreal, Q.  
St. Jean & Guenette, Montreal, Que.  
St. Pierre, J. N., Quebec, Que.  
Standard Boot Co., Ltd., Quebec, Q.  
Sutherland, F. F., & Co., St. John,  
[N.B.  
Taylor, Robert, Halifax, N.S.  
Taylor, R., & Co., Halifax, N.S.  
Thibaudeau, Chas., & Co., Montreal,  
[Que.

Thurston, E. H., Montreal, Que.  
Vinette, O., & Co., Montreal, Que.  
Webster, A. J., & Co., Shediac, N.B.  
Weston, F. J., & Sons, Toronto, Ont.  
Whitman, Jas., & Co., Montreal, Q.  
Whitney & Brown, Montreal, Que.  
Williams, D. H., & Son, Hamilton,  
Williams, S. L., Galt, Ont. [Ont.

## MANUFACTURERS.—Cotton Goods.

Dominion Cotton Mills Co., Ltd.,  
Mills at Hochelaga, Que.; Coati-  
cooke, Que.; Chambly, Que.;  
Brantford, Ont.; Kingston, Ont.;  
Halifax, N.S.; Moncton, N.B.;  
Windsor, N.S.; Magog, Que.  
Dominion Colored Cotton Mills Co.,  
Ltd. Mills at Cornwall, Ont.;  
Hamilton, Ont.; Merriton, Ont.  
Hamilton Cotton Co., Hamilton, Ont.  
Montmorenci Cotton Co., (The)  
[Montmorenci Falls, Que.  
Montreal Cotton Co., Montreal, Que.  
Parks & Son, Ltd., St. John, N.B.

## MANUFACTURERS.—Flour, Feed and Meal.

Ackland, J., Delaware, Ont.  
Adams, J. F., & Son, Tracy's Mills,  
[N.B.  
Adams & Mason, New Maryland,  
[N.B.  
Alexander, Kelly & C., Brandon, Man.  
Alger, Wm. E., Johnville, Que.  
Almstead & Clark, Waterfalls, Ont.  
Anderson, Wm., Corbin, Que.  
Andre, L., Ste. Lucie de Doncaster,  
[Que.  
Archibald, John M., Beachville, Ont.  
Argle, M. L., Newcastle, Ont.  
Armstrong, Geo., Armstrong's Mill,  
[Ont.  
Asborne, George, Elizabethville, Ont.  
Askew, J., Leamington, Ont.  
Assessippi Milling Co., Assessippi,  
[Man.  
Aube, C., St. Eustache, Que.  
Aube, D., Matane, Que. |  
Auger, Pierre, Ste. Agathe des  
[Monts, Que.  
Babcock & Edawrds, Lakefield, Ont.  
Baker, J. H., Ridgetown, Ont.  
Bald, John, Sebringville, Ont.  
Baldwin, Geo. S., Aurora, Ont.  
Ball, John, Baltimore, Ont.  
Baillie, Robt., Union, Ont.  
Banfield, J., Killaloe, Ont.

GENERAL LIST OF CANADIAN MANUFACTURERS.

- Barnes, S., Oil Springs, Ont.  
 Barratt, Harold Co., (The), Port Hope, Ont.  
 Barter, G., London, Ont.  
 Bartlett, Edw'd. H., Bartlett Mills, [N.B.]  
 Bartholomew, H., Vanessa, Ont.  
 Beach, M. F., & Co., Iroquois, Ont.  
 Beaton, Duncan, Passekeag, N.B.  
 Beaudet, Geo. J., Coteau du Lac, Que.  
 Beaudoin, A., St. Henri, Que.  
 Beaudoin, D., Ste. Sophie D'Halifax, [Que.]  
 Beausoleil, Jos., St. Felix de Valois, [Man.]  
 Beautiful Plains Milling Co., Ltd., [Neepawa, Ont.]  
 Bender, Albert, Montmagny, Que.  
 Benjamin, J. W., West Brome, Que.  
 Bennett, T. H., Cumminsville, Ont.  
 Bennett & Constable, Spencerville, O.  
 Bennett, W., Vienna, Ont.  
 Benoit, J., St. Janvier de Weedon, Q.  
 Bergeron, A., St. Gregoire, Que.  
 Bergeron, L., St. Gabriel de Brandon, [Que.]  
 Bergeron & Poirier, St. Celestin, Que.  
 Bernard, Jos., Yamachiche, Que.  
 Bertrand, Paul, Masham Mills, Que.  
 Bertrand, S., Plessisville, Que.  
 Bessette, S., & Son, St. Edouard, Q.  
 Bhereur, Thos., Murray Bay, Que.  
 Bigeold, W. & M., Maria, Que.  
 Bilodeau, A., Beaurivage, Que.  
 Bisch, J., Linwood, Ont.  
 Bishop, J., Inkerman, Ont.  
 Black & Kerr, St. Catharines, Ont.  
 Black & Barnard, Wroxeter, Ont.  
 Blain, John K., Sterling Falls, Ont.  
 Blouin, Nap., St. Sylvestre East, Q.  
 Boileau, D., Milton, Que.  
 Boon, C., Arundel, Que.  
 Bordleau, E., Joliette, Que.  
 Bougie, O., St. Louis Station, Que.  
 Bourret, H., St. Guillaume D'Upton, [Que.]  
 Boyd, John, Belmont, Ont.  
 Brackenridge, J. A., Nottawa, Ont.  
 Brackenridge, John, Westwood, Ont.  
 Brackman & Ker Milling Co., Ltd., [Victoria, B.C.]  
 Bradford Roller Flour Mills, [Bradford, Ont.]  
 Bramm Bros., Berlin, Ont.  
 Brissette, Jos., St. Barthelemo, Que.  
 Britton, J., Iona, Ont.  
 Brokenshire, D., Haydon, Ont.  
 Brown, W. H., & Co., Simcoe, Ont.  
 Brown, Alex., & Co., Toronto, Ont.  
 Brown, D., Compton, Que.  
 Brown, David, Bathurst, N.B.  
 Brown, E. A., Brownsville, Ont.  
 Brown, John, Dunnville, Ont.  
 Brown, J. P., St. Chrysostome, Que.  
 Brown, W., Paisley, Ont.  
 Brown, H., & Son, Carleton Place, O.  
 Brown, W. B., & Co., Simcoe, Ont.  
 Bruce, Robt. (Estate of) Gormley, O.  
 Bubar, James, Upper Brighton, N.B.  
 Bugole, Wm., Maria, Que.  
 Bureau, Z., Lambton, Que.  
 Burnett, S., St. Davids, Ont.  
 Burr, M. B., Concession, Ont.  
 Byram, P. O., Power's Creek, N.B.  
 Cadman, A., Holloway, Ont.  
 Caldwell, J., Cavanville, Ont.  
 Caldwell, J., Columbia, Ont.  
 Caledonia Milling Co., Ltd., [Caledonia, Ont.]  
 Caledonian Mills, Bowmanville, Ont.  
 Calhoun, John R., St. John, N.B.  
 Callery Bros., Cannifton, Ont.  
 Cameron, John, Trout River, Que.  
 Cameron & Cameron, Glencoe, Ont.  
 Campbell, Archibald, Toronto, Ont.  
 Campbell, D., Whycocomagh, N.S.  
 Campbell, J., St. Thomas, Ont.  
 Campbell, S., Carlisle (Wentworth), [Ont.]  
 Campbell, S., Progresstown, Ont.  
 Campbell & Norris, Boston Mills, O.  
 Campbell & White, Oshawa, Ont.  
 Campbell Bros., Ventnor, Ont.  
 Cantin, H., St. Patrick's Hill, Que.  
 Carriere, E., St. Canute, Que.  
 Carr, Thomas, Commanda, Ont.  
 Carr, John, Wingham, Ont.  
 Carter, F., & Co., Chippawa, Ont.  
 Carter, Geo., Son & Co., St. Mary's, [Ont.]  
 Carther, W., Oakdale, Ont.  
 Cavanagh, John, New Annan, N.S.  
 Chabot, G., Armagh, Que.  
 Chalifoux, Samuel, St. Alban, Que.  
 Chapman, C., Prescott, Ont.  
 Charest, Ed., St. Barnabe, Que.  
 Chartier, E., St. Leonard, Que.  
 Cherry, S. J., Preston, Ont.  
 Chisholm, Duncan F., Lismore, N.S.  
 Chisholm, M. D., Long Point, N.S.  
 Churchill, W. H., Innisville, Ont.  
 Clark, D., Ayr, Ont.  
 Clarke & Sons, Glencoe, Ont.  
 Clark, John S., Warwick, Ont.  
 Clement, R. B., Walkerton, Ont.  
 Clendenning, W. H., Carman, Man.  
 Clifford, A., Janetville, Ont.  
 Clifford, Walter, Austin, Man.  
 Clouston, Joseph, St. Andrews, Man.  
 Coalfleet, R. H., & Co., Windsor, N.S.  
 Cochrane, J. W., Crystal City, Man.  
 Cody, G., Cody's, N.B.  
 Coggin, C. & S., Elgin, N.B.  
 Columbia Milling Co., Enderby, B.C.  
 Comstock, D., Kendal, Ont.  
 Couture, Ed., St. Paul du Buton, Q.  
 Cook, Thomas, Carrville, Ont.  
 Cook, Thomas, Chaffey's Locks, Ont.  
 Cook Bros., Hensall, Ont.  
 Cook, Jesse, Zephyr, Ont.  
 Cookshire Flour Mill Co., Cookshire, [Que.]  
 Cooper, R. B., Belleville, Ont.  
 Cooper, S. M., Oakville, Ont.  
 Cornell, M. S., Stanbridge East, Que.  
 Cornish, J. W., Leskard, Ont.  
 Cossette, H. P., St. Narcisse, Que.  
 Cote, Joseph, St. Fortunat, Que.  
 Cote, Jos., St. Pierre D'Orleans, Que.  
 Couturier, P., St. Paschal, Que.  
 Cox, James A., Treherne, Man.  
 Craig, David, Arnprior, Ont.  
 Craig, Bro., Napanee, Ont.  
 Cranston & Scringer, Galt, Ont.  
 Crathorne, George A., Dartmouth, Credger, M., Ripon, Que. [N.S.]  
 Crooks, J. J., Grenville, Que.  
 Cronse, B. M., Bridgewater, Ont.  
 Crouse, J. W., Byron, Ont.  
 Cumming, James, Lyn, Ont.  
 Cumming, J., Burtch, Ont.  
 Cunningham & Curren, Halifax, N.S.  
 Curran, Terrence, West Branch, N.B.  
 Curran, W. D., Corbin, Que.  
 Dafoe, J. R., Napanee, Ont.  
 Dalrymple, Geo., Lakeside, Ont.  
 Dane, W., Gorrie, Ont.  
 Davidson, Munro & Co., [Peterborough, Ont.]  
 Day, T. D., Aberfoyle, Ont.  
 Denison, I. & J., Danville, Que.  
 Denis, L., Lalonde, Ont.  
 Denne, V., & Son, Newmarket, Ont.  
 Dennis, W. J., Schomberg, Ont.  
 Deschenes, A., Trois Pistoles, Que.  
 Desroche, A., St. Nicholas, Que.  
 Dewar, Daniel, Wallace, N.S.  
 Dexter, D., & Son, Sebringville, Ont.  
 Dickie, John, Shediac, N.B.  
 Dickinson, G. L., Manotick, Ont.  
 Dickson, D., Richard's Landing, Ont.  
 Dilworth & Patterson, Ethel, Ont.  
 Dion, R., St. Neree, Que.  
 Disher, T., & Son, Dungannon, Ont.  
 Dixon, J., Boyne Mills, Ont.  
 Dixon, M., Cashmere, Ont.  
 Dobson & Campbell, Beaverton, Ont.  
 Doherty, James, Upham, N.B.  
 Doherty, Jos., Escuminac, Que.  
 Doherty, R. N., St. Nicholas River, [N.B.]  
 Dore, T. & N., Norton Creek, Que.  
 Draper, Thomas, Brantford, Ont.  
 Drewry, J., Newburg, Ont.  
 Drewry Bros., Smithfield, Ont.  
 Drover, Moses, Witless Bay, N.F.  
 Dumouchel, D., Ste. Adele, Que.  
 Duncombe, A. C., Waterford, Ont.  
 Dunlop, M., Arkona, Ont.  
 Dupe, Paul, Grand Metis, Que.  
 Dupe, Paul, Little Metis, Que.  
 Duplessis, O., Pointe du Lac, Que.  
 Durault, Ovide, St. Camille, Que.  
 Dyke, C., Siloam, Ont.  
 Eager & Sanderson, Winchester, O.  
 Eakins, D., Unionville, Ont.  
 Easton, H., Merrickville, Ont.  
 Eckhardt, George, Beamsville, Ont.  
 Edmonds, E., Lynn Valley, Ont.  
 Eidt, J., Dashwood, Ont.  
 Elder, D., Elder's Mills, Ont.  
 Elliott, T. H., Cheltenham, Ont.  
 Elliott, Thos., Lampton Mills, Ont.  
 Elliott, William, Chesley, Ont.  
 Ellis & Co., Vernon, B.C.  
 Erb, M. A., Apohaqui, N.B.  
 Estey, R. A., Fredericton, N.B.  
 Eyre, T., North Augusta, Ont.  
 Falt, J. W., & Sons, Antigonishe, N.S.  
 Farmers' Elevator & Milling Co., The, [Alexander, Man.]  
 Fairles Bros., Merrifton, Ont.  
 Fair, James, Clinton, Ont.

**GENERAL LIST OF CANADIAN MANUFACTURERS.**

Fairweather, C. D., Kingston (Kings) [N.B.]	Grimmer, J. D., Chamcook, N.B.	Hutchison, E., Spring Arbor, Ont.
Fawcett, Charles, Moncton, N.B.	Grondin & Labbe, St. Elizear, Que.	Huxtable, J., Hornings Mills, Ont.
Ferguson, Alex., Rocky Saugeen, Ont.	Groves Bro., Fergus, Ont.	Ireland Nation Food Co., Ltd. (The), [Toronto, Ont.]
Ferguson & Powell (Est. of) Melita, [Man.]	Guerard, Joseph, St. Francois [D'Orleans, Que.]	Inglis, W. A., Owen Sound, Ont.
Ferland & Fils, St. Canute, Que.	Guilbeau, S., St. Augustin, Que.	Ingram, Ed. R., Aylmer, Ont.
Fensom, George, Elmwood, Ont.	Gullett, Wm., Wellman's Corners, O.	Ingram & Eggleton, Aylmer, Ont.
Fenwick, Everett, Mill Stream, N.B.	Haggart, J. G., & Co., Perth, Ont.	Ironside, A., Granton, Ont.
Fenwick, W. S., Enterprise, Ont.	Hagerman & Dodds, Orchard, Ont.	Irwin, John, Warton, Ont.
Field, J., Hartford, Ont.	Halle, E., St. Anselme, Que.	Jackson, Jas., Ancaster, Ont.
Finnemore, W. H., Burlington, Ont.	Hamilton, John, Embro, Ont.	Jarman, H. W., L'Amable, Ont.
Fleming, J., Dresden, Ont.	Hamlyn, H., Lambeth, Ont.	Jasperson, G., & Co., Kingsville, Ont.
Fletcher, W. J., Alliston, Ont.	Hammett Bros., Franklin, Ont.	Jeffries, Hugh, Sussex Corner, N.B.
Forget, D. & N., St. Janvier, Que.	Haney, S., Dunneville, Ont.	Johnson, W. A., Dresden, Ont.
Fortier, A., Halifax South, Que.	Hanham, H., Port Colborne, Ont.	Johnston, John, Waldemar, Ont.
Fortier, M., Ste. Henedine, Que.	Harding, J. M., Kemptville, Ont.	Joyner & Elkington, Fort Qu'Appelle, [N.W.T.]
Fortier, W., St. Philomene, Que.	Harland, E., High Gate, Ont.	Kelly, Alexander, & Co., Brandon, [Man.]
Fortin, R., St. Alexandre, Que.	Harper & Clark, Dundas, Ont.	Kemp, C., Leith, Ont.
Foulds, F. W., Hastings, Ont.	Harrison, E. & Son, Onodaga, Ont.	Kendrew, A., Pond Mill, Ont.
Foulds & Shaw, Oakville, Ont.	Harris, F., Springfield, Port Credit, [Ont.]	Kennedy, K., Hobart, Ont.
Fournier, L., Montmagny, Que.	Hartop, H., Everton, Ont.	Kennedy, Davis & Son, Lindsay, Ont.
Fowler, W. H., St. John's N.B.	Haskins, George, Delta, Ont.	Kent, John L., Granby, Que.
Fowler & Calhoun, St. John, N.B.	Hastings, William, Cross Hill, Ont.	Kent, J. L., Mawcook, Que.
Fownes, John, Pollet River, N.B.	Hathaway, Edward, Arthur, Ont.	King, James, Sarnia, Ont.
Francis, J. H., Pakenham, Ont.	Hau, C. H., Ridgeway, Ont.	Kerr Bros., Wales, Ont.
Francoeur, T., St. Aubert, Que.	Hawkesbury Milling Co., Hawkesbury, Ont.]	Kinsman, W. H., Canton, Ont.
Fraser, Byron, Morden, Man.	Hawkins, J., St. Johns, Ont.	Knott, Robert, Richmond, Ont.
Fraser, Donald, Muniac, N.B.	Hayne, T. W., Bridgen, Ont.	Knott, William, Carlingford, Ont.
Frazier, Thomas E., Mabou, N.S.	Hayward, G., & Son, Port Elgin, N.B.	Knox, J., & Co., Stayner, Ont.
Fraser, Wm., Fraserville, Que.	Heimbecker, George, Hanover, Ont.	Kribs, Louis, Hespeler, Ont.
Fredenburgh, W. H., Westport, Ont.	Henault, S., L'Epiphanie, Que.	Labrie, Alfred, St. Charles, Que.
Gagne, Jos. J., Lake Temiscouata, Q.	Henderson, A. (Est. of), Huntingdon, [Que.]	Lacourciere, A., St. Narcisse, Que.
Gagne, X., Maria, Que.	Herron, J. & J., Lanark, Ont.	Lafrance & Gueven, St. Monique, Q.
Gagnon, C., L'Avenir, Que.	Hetherington, H. J., Newbury, Ont.	Lair, P., Lotbiniere, Que.
Gagnon, L., Ste. Therese, Que.	Hewson Bros., Durham, Ont.	Lajoie, I., St. Paschal, Que.
Galbraith, Jno., Allandale, Ont.	Hewson & Charlebois, Penetanguishene, Ont.]	Lake & Bailey, Hamilton, Ont.
Galt Milling Co., Galt, Ont.	Hilborn, Jacob, Blair, Ont.	Landry, Ed., Kingsey Falls, Que.
Garant, Jos., Caplin River, Que.	Hilborn & Brubacher, Berlin, Ont.	Langevin, E., Jr., St. Timothe, Que.
Garceau, Thos., Pointe du Lac, Que.	Hickey, M., Montreal, Que.	Langille, James, Martin's River, N.S.
Gardiner, R., Forrester's Falls, Ont.	Hill, W., Hanover, Ont.	Lapien, Z., Shawenegan, Que.
Gavin, H., Kensington, Que.	Hill, W. H., Sarnia, Ont.	Lapointe, A., Ste. Justine de Newton, [Que.]
Gelinas, J. B., St. Sylvere, Que.	Hislop, D., Headford, Ont.	Larmouth, J., Fitzroy Harbor, Ont.
Geoffroy, N., St. Jean de Matha, Que.	Hodd & Cullen Milling Co. (The), [Stratford, Ont.]	Larivee, Chas., Ste. Flavie, Que.
Gibson, W., & Co., Morrisburg, Ont.	Hodges & Son, Woodstock, Ont.	Larose, T., St. Janvier, Que.
Gilbert & Lockwood, Moulinette, O.	Holland, G. H. & F., Ingersoll, Ont.	Laurent, A., St. Beatrix, Que.
Goldie, James, Guelph, Ont.	Hollingshead, H., Dutton, Ont.	Lavigne, N., St. Lazare de Vaudreuil, [Que.]
Goldie Milling Co., Ltd., Ayr, Ont.	Hollinshead & Co., Chilliwack, B.C.	Lavoie, Francois, Parc Laval, Que.
Goodrich, R., Sr., Dundonald, Ont.	Hood, Thomas, Cargill, Ont.	Lawson, Bros., Toronto, Ont.
Gosselin, Francois, St. Laurent [D'Orleans, Que.]	Hood, Thomas, Cargill, Ont.	Law, William, Ancaster, Ont.
Gould Bros., Uxbridge, Ont.	Hoover, B., Markham, Ont.	Layfield, Geo., Gould, Que.
Govenlock, A., Winthrop, Ont.	Hoover, P. R., Green River, Ont.	Leask, G., Leaskdale, Ont.
Gibson, Wm., Rockburn, Que.	Horner, D. C., West Shecord, Que.	LeBlanc, Laurent, Richibucto Village, [N.B.]
Girard & Freres, St. Leonard, Que.	Houle, M., Ste. Victoire, Que.	Lebuffe, Robt., New Richmond, Que.
Giroux, F. X., & Fils, Charlesbourg, [Que.]	Howard, J. & P. R., Hagersville, O.	Leclerc, A., L'Islet, Que.
Graham, R. B., River John, N.S.	Howes, J., Harriston, Ont.	Leclerc, C., St. Jean de Dieu, Que.
Grant, C. J. H., Orangeville, Ont.	Howland, H. S., Kleinburg, Ont.	Leclerc, E., L'Islet, Que.
Grant, J. C., Waterville, Que.	Howlett, J., Glen Morris, Ont.	Leclerc, Pierre, Riviere a Claude, Q.
Grant & Wainwright, Virden, Man.	Howson, Bros., & Co., Teeswater, O.	Lee, J., & Son, Walkerton, Ont.
Granville, John & McVittie, Southampton, Ont.]	Hudson, I., Dentfield, Ont.	Lefebvre, Arthur, St. Stanislas, Que.
Grass, C., Brooklin, Ont.	Hudon, Jos., St. Paschal, Que.	Lefebvre, E., St. Appollinaire, Que.
Gravel, G., St. Damien, Que.	Hughes, Hart & Morris, Wapella, [N.W.T.]	Leith, M., Coulson, Ont.
Graves, G. A., Marchmont, Ont.	Hulbert, John G., Lochaber, N.S.	Lemay & Rousseau, St. Nicholas, Qu.
Graves, Campbell & Co., Crystal City, [Man.]	Hull, J., Lakefield, Ont.	Lemire, A., Yamachiche, Que.
Gray, James, Rockwood, Ont.	Hunter, John D., Gooderham, Ont.	Lemire, E., St. Valere de Bulstrode, [Que.]
Gregoire, R., L'Epiphanie, Que.	Hunter, W., Dacre, Ont.	
Griffin, O., Frogmore, Ont.	Hurt & McKay, Boissevain, Man.	

## GENERAL LIST OF CANADIAN MANUFACTURERS.

- Lemire, O., St. Valere de Bulstrode, [Que  
 Lemieux, J., St. Lambert, Que.  
 Levesque, Thos., St. Pacome, Que.  
 Lewis, W. F., Grimsby, Ont.  
 Lingham, Wm., Belleville, Ont.  
 Lipsey & Stickney, Elora, Ont.  
 Lockhart, Samuel, Smith's Falls, Ont.  
 Loiseau, Dr. C., St. Eustache, Que.  
 Longchamps, H., St. Henri, Que.  
 Loranger, E., Ste. Anne de la Perade, [Que
- Loux, A., Russell, Ont.  
 Love, E., Kettleby, Ont.  
 Lyons, J., Bornholm, Ont.  
 McArthur, A., & Son, S. Lancaster, O.  
 McCabe, M., Grafton, Ont.  
 McCahill, N., & Co., Forest, Ont.  
 McCargar, P. G., Peterboro', Ont.  
 McCuaig, Robt., L'Avenir, Que.  
 McCulloch, George, & Co., Rapid City, [Man.
- McCullock, J., Harwood, Ont.  
 McDade, Wm., Barnesville, N.B.  
 McDonald, Chas, Baddick, N.S.  
 McDonald, Chas., Bailey's Brook, [N.S.
- McDonald, Donald, Boisdale, N.S.  
 McDonald, H., Belwood, Ont.  
 McDonald, William, Sandfield, Ont.  
 McDonald, G., Yarker, Ont.  
 McDonald & Thompson, Woodstock,  
 McDougall & Brandon, Fenelon Falls, [Ont.
- McDugall, J. P., Maxville, Ont.  
 McElwaine, W., Ballyeroy, Ont.  
 McFarlane, Robt. R., Bristol, Que.  
 McGeorge, John, St. Sylvestre East, [Que
- McGibbon, Donald, Arkona, Ont.  
 McGinnis, C., Edgar, Ont.  
 McGregor, Peter, Sussex, N.B.  
 McGugan, A., St. Thomas, Ont.  
 McInnes, C., Orillia, Ont.  
 McIntosh, Murdoch, Durham, N.S.  
 McIntyre & McDonald, Oxford Mills, [Ont.
- McIver, G., Mill Brook, Ont.  
 McKay, J. H., Combermere, Ont.  
 McKay, John, Bowmanville, Ont.  
 McKay Milling Co., Ottawa, Ont.  
 McKay & Guest, Renfrew, Ont.  
 McKay & Hyde, Lequille, N.S.  
 McKenzie, R., Lambton, Que.  
 McKenzie, Wm., Upper Stewack, N.S.  
 McKinnon & Kennedy, Portage la [Prairie, Man.
- McKnight & Solomon, Forest Mills, O.  
 McLaren, John, Renfrew, Ont.  
 McLean, Duncan, Long Creek, N.B.  
 McLean, H. M., Quyon, Que.  
 McLean & Carlyle, Otterville, Ont.  
 McLellan, Reid & Shanneman, [Gananoque, Ont.
- McNiven, A., Woodham, Ont.  
 McPherson Bros., Pugwash, N.S.  
 McQuibban, J., Harriston, Ont.  
 McRae, Bros., Wickham, N.B.  
 McRae & McKenzie, Eganville, Ont.  
 McVean, S., Dresden, Ont.
- McVean, O. & H., Dresden, Ont.  
 MacFarlane Milling Co. (The), [Sherbrooke, Que.
- Mack, Wm., Cornwall, Ont.  
 Magnan, T., Ste. Theole, Que.  
 Magnan, Freres, St. Ubalde, Que.  
 Magnan, O., L'Epaphanie, Que.  
 Mahon & Sumner, Truro, N.S.  
 Malouin, L., Pont Chateau, Que.  
 Marchand, Jacob, Beauharnois, Que.  
 Marchand, T., Champlain, Que.  
 Marchand, T., Ste. Genevieve de [Batiscan, Que.
- Marier, D., Old Lake Road, Que.  
 Martin, G. E., Lindsay, Ont.  
 Martin Bros., Mount Forest, Ont.  
 Martin, J., & Co., Alvinston, Ont.  
 Martin & Warnock, Ottawa, Ont.  
 Matthews, T., Kinglake, Ont.  
 Mayhew & Meyers, Glen Miller, Ont.  
 May Bros., St. Thomas, Ont.  
 Meek, Robert, Alton, Ont.  
 Meldrum & McAllister, Peterboro', O.  
 Meriless & Co., Almonte, Ont.  
 Meyers, Alex., & Son, Sombra, Ont.  
 Middaugh & Richardson, Hamilton, [Ont.
- Milburn, C. & J., Desboro, Ont.  
 Migneault, V., St. Jude, Que.  
 Miller, J., Ringwood, Ont.  
 Miller, S. A., Jerseyville, Ont.  
 Miller & Sloat, Tracey's Mills, N.B.  
 Milne, H. D., Markham, Ont.  
 Milne, J. A., Powassan, Ont.  
 Mitchell Roller Flouring Mills, [Mitchell, Ont.
- Moffatt & Co., Morewood, Ont.  
 Mooney, J. O. & H., Alexandria, Ont.  
 Moore, Bertram L., Moore's Mills, [N.B.
- Moore, H. S., Norwich, Ont.  
 Moore, Jas. A., Waterford, N.B.  
 Moore, J. D., St. Mary's, Ont.  
 Moore, W., & Son, Meaford, Ont.  
 Morden, J. M., Greenville, Ont.  
 Morency, G., Ste. Marie, Que.  
 Morency, Nap., Ste. Marie, Que.  
 Morice, William, Sackville, N.B.  
 Morin, A., Armagh, Que.  
 Morin, Pierre, St. George de Windsor, [Que
- Morin, O., & Son, St. Pie, Que.  
 Morley, J., New Hamburg, Ont.  
 Morningstar & Minor, Humberstone, [Ont.
- Morrill, J. A., Danville, Que.  
 Mount Royal Milling & Mfg. Co., [Montreal, Que.
- Mower, J., Camboro', Ont.  
 Moyer, A., & Co., Listowel, Ont.  
 Moyer, A., & Co., Palmerston, Ont.  
 Muir & Ross, Mattawa, Ont.  
 Muller & Wiebe, Rosengart, Man.  
 Murton, H., Guelph, Ont.  
 Mustard, H., Wyoming, Ont.  
 Nadeau, H., St. Elizabeth, Que.  
 Nadeau, L., La Fayette, Que.  
 Nadeau, T., Beaurivage, Que.  
 Naylor, James, Essex, Ont.  
 Nichol, G., Canning, Ont.
- Nichols, C. O., Waterville, N.S.  
 Nickle, John, & Son, Queensboro', O.  
 Nicol, J., Nicolston, Ont.  
 Neill, Robt., New Armagh, Que.  
 Nelson, Lewis, Windsor Mills, Que.  
 Newton, Albert, Morin Flats, Que.  
 Newton, John, Morin Flats, Que.  
 New Glasgow Milling Co., Ltd. (The) [New Glasgow, N.S.
- Noble Robert, Norval, Ont.  
 Norris, Wm., Effingham, Ont.  
 Nottawasaga Farmers' Milling Co., Ltd. (The)  
 Ogilvie, W. W., Seaforth, Ont.  
 O'Brien, Peter, Waterton, Ont.  
 O'Neill, Thomas, Paris, Ont.  
 Omstead, Daniel, Wheatley, Ont.  
 Osprey Farmers' Milling Co., Ltd., [Feverham, Ont.
- Orr Bros., Windsor, Ont.  
 Osterhout, John D., Rose Hall, Ont.  
 Ouellette, C., Ste. Onezime, Que.  
 Paris, James, Whitelake, Ont.  
 Paradis, P., Charlesbourg, Que.  
 Parker, William, Sheldon, Ont.  
 Partlo, H. W., Dorchester Station, O.  
 Partlo, W., Ingersoll, Ont.  
 Paterson, B., Borritt's Rapids, Ont.  
 Pearen Bros., Brampton, Ont.  
 Pearson, Wm., Singhampton, Ont.  
 Peers, G., Udora, Ont.  
 Pembroke Milling Co., Pembroke, O.  
 Pender, G. & D., Hampstead, N.B.  
 People's Flour Mill, Bradford, Ont.  
 Perras & Hamel, St. Alexandre, Que.  
 Peterham, J. B., Duncrief, Ont.  
 Peters, F. S., Richibucto, N.B.  
 Petipiece, S., Burritt's Rapids, Ont.  
 Pettman, Thomas, Oxenden, Ont.  
 Phramer, M., Benmiller, Ont.  
 Pillow, W. T., Port Albert, Ont.  
 Pincombe, A. A., Strathroy, Ont.  
 Pineo, Geo. D., Waterville, N.S.  
 Plante, Adelard, Armagh, Que.  
 Plante, Ed., Halifax South, Que.  
 Plewes & Spence, Creemore, Ont.  
 Plewes & Vogan, Walkerton, Ont.  
 Plowright, J. F., Columbus, Ont.  
 Pooock & McGowan, Emerson, Man.  
 Poitras, E. M., Belle Riviere, Que.  
 Pollock, J. L., Drayton, Ont.  
 Portelance, N., L'Orignal, Ont.  
 Potter, T., King Creek, Ont.  
 Poucher, D., Plainfield, Ont.  
 Poulin, Alex., Ste. Famille, Que.  
 Pratt, A., Cobourg, Ont.  
 Pratt, George, York Mills, Ont.  
 Presant, E. J., Guelph, Ont.  
 Prince Bros., Battleford, N.W.T.  
 Prosser, Geo., Savage's Mills, Que.  
 Pryne, William, Siloam, Ont.  
 Quance Bros., Delhi, Ont.  
 Quinn & Patterson, Newington, Ont.  
 Rafuse, Jas., Martin's River, N.S.  
 Ramsden, John A., Franklin, Ont.  
 Rankin, D. J., Collin's Bay, Ont.  
 Reardon, J. J., Pockshaw, N.B.  
 Redstone, Malcolm, New Jerusalem, [N.B.
- Redstone, T. W., Gagetown, N.B.

## GENERAL LIST OF CANADIAN MANUFACTURERS.

- Reimer, K. W., St. Steinback, Man.  
 Remillard, P., St. Raphael, Que.  
 Rennie, E., St. Prospere de Dorchester, Que.  
 Ripley, D. G., Westport, Ont.  
 Rice, J. V., Riceburg, Que.  
 Richard, J., St. Elizabeth, Que.  
 Rideout, S. J., Upper Kent, N.B.  
 Riendeau, A., Village Richelieu, Que.  
 Ritchie, Peter, Orillia, Ont.  
 Rivard, Jos., & Frere, Petite Matane, [Que
- Robertson, James, Kelvin, Ont.  
 Robertson, R., Burnstown, Ont.  
 Robert, J. B., Beauharnois, Que.  
 Roblin, E., Ameliasburg, Ont.  
 Robson, W. B., Hamilton, Ont.  
 Robson, J. & R., Brantford, Ont.  
 Rock Bros., Springford, Ont.  
 Rodd, James, Galt, Ont.  
 Ross, D. R., Embro, Ont.  
 Ross, William, Brussels, Ont.  
 Ross & Howden, Raglan, Ont.  
 Ross, Jno. W., & Co., Oxford, N.S.  
 Roy, Joseph, St. Jude, Que.  
 Roy, Nap., St. Anselme, Que.  
 Ruel, D., St. Romain, Que.  
 Runcimann & Platt, Port Albert, O.  
 Rutherford, J. B., & Co., Stonewall, [Man.
- Rutherford, Jas., & Sons, Middle [Stewiacke, N.S.  
 Ruthing, J. M., St. Mary's, Ont.  
 Ryan, W., Komoka, Ont.  
 Sadler, Dundas & Co., Lindsay, Ont.  
 Sarnia Mills, Sarnia, Ont.  
 Saunby, J. D., London, Ont.  
 Saunty, S. B., Dungannon, Ont.  
 Schmidt, H. B., Newton, Ont.  
 Schneider, G. W., Dorking, Ont.  
 Schrodder, John, Sheguindah, Ont.  
 Scott, J., Lakelet, Ont.  
 Scott Bros., Galt, Ont.  
 Seebach, L., Carlingford, Ont.  
 Selkirk Roller Mill Co., Selkirk West, [Man.
- Semple, A., Fergus, Ont.  
 Sharp, Isaac N., Mill Stream, N.B.  
 Sharp, Marshall, Waterford, N.B.  
 Shaw Bros., Lake Dauphin, Man.  
 Shaw & Co., Port Dover, Ont.  
 Shaw, H., Victoria, Ont.  
 Shepherd, G., & Son, Primrose, Ont.  
 Sheriff & Knox, Cumberland, Ont.  
 Shirk, P., Baden, Ont.  
 Shirk & Snider, Bridgeport, Ont.  
 Shortreed Bros., Hillsdale, Ont.  
 Shrubsole, J., Crownhill, Ont.  
 Shuswap Milling Co., Kamloops, B.C.  
 Sinden, W. K., Eden, Ont.  
 Simmons, Austin & Co., Wilton, Ont.  
 Sloan, W., Brantford, Ont.  
 Sloat & Zebedee, Tracey's Mills, N.B.  
 Smith, Bowen, Cocaigne, N.B.  
 Smith, Charles, Campbellford, Ont.  
 Smith, George, Port Elgin, Ont.  
 Smith, G. E., Demorestville, Ont.  
 Smith, H., Byron, Ont.  
 Smith, J., Ingersoll, Ont.  
 Smith, R. W. & J. H., Jarvis, Ont.
- Snider, B. S., Port Elmsley, Ont.  
 Snider, E. W. B., St. Jacobs, Ont.  
 Snider, M., Connestogo, Ont.  
 Snider, Wm., & Co., Waterloo, Ont.  
 Snyder, C. M., St. Ann's, Ont.  
 Snyder, M., Salem, Ont.  
 Somers, D., Shinimicas, N.S.  
 Souch, S., Bowmanville, Ont.  
 South, J. W., Brampton, Ont.  
 Sproule, J., Lakeport, Ont.  
 Squire, N. M., New Lowell, Ont.  
 Squire Bros., Norwood, Ont.  
 Standish, Jas., Rougemont, Que.  
 Stanley & Dight, Lucan, Ont.  
 Stephenson Bros., Laskey, Ont.  
 Stephens, M. N., Glencairn, Ont.  
 Stephens, N. H., Chatham, Ont.  
 Sterling & Vizard, Bridgen, Ont.  
 Stevens, N. H., Chatham, Ont.  
 Stevens & Sinclair, Aylmer, Ont.  
 Stewart, C., Harrowsmith, Ont.  
 Stewart, J. R., Barrie, Ont.  
 Stewart & Evans, Strathroy, Ont.  
 Stewart & Graham, Brussels, Ont.  
 Stuart, Peter, & Co., Ingersoll, Ont.  
 Sturgeon River Flour Milling Co., [Sturgeon River, N.W.T.
- Stokes, Thomas, Pefferlaw, Ont.  
 Stortts, R., Demorestville, Ont.  
 Suttter & Cullen, Woodstock, Ont.  
 Summerfeldt Bros., Cannington, Ont.  
 Sutton, W., Simcoe, Ont.  
 Sutherland, William, Harrington, O.  
 Swan, John, New Anna, N.S.  
 Switzer, Ezra, Violet, Ont.  
 Sweitzer, H. J., Crediton, Ont.  
 Tait, C. H., Merrickville, Ont.  
 Telfer Bros., Clarksburg, Ont.  
 Tetu, E., Craig's Road Station, Que.  
 Therien, A., St. Romain, Que.  
 Thompson, Chas., Nine Mile River, [N.S.
- Thompson, D. C., Orillia, Ont.  
 Thompson, R. A., Lynden, Ont.  
 Thompson, Walter, London, Ont.  
 Thursk, John, Blake, Ont.  
 Thurston, A., Painswick, Ont.  
 Tilson, E. D., Tilsonburg, Ont.  
 Todd Milling Co., Galt, Ont.  
 Treherne Farmers' Elevator & Milling Co., Treherne, Man.  
 Tremblay, Rich., Chateau Richer, Q.  
 Trenholm, Abijah, Point du Bute, [N.B.
- Troup, Geo. W., Sherkston, Ont.  
 Turville, George, St. Thomas, Ont.  
 Underhay Bros., Adelaide, Ont.  
 Vanderburg, J., Effingham, Ont.  
 Van Luven, Solomon W., Prince [Albert, N.W.T.
- Vanstone, J. C., Bowmanville, Ont.  
 Verret, Jos., Edmunston, N.B.  
 Vickerman, D., Campbellville, Ont.  
 Vick, George, Orillia, Ont.  
 Victoria Mills, Guelph, Ont.  
 Victoria Flour Mills, Lindsay, Ont.  
 Villeneuve, P., & Co., Lac Masson, Q.  
 Vivian, Rich., St. Odilon de Cranbourne, Que.  
 Vollens, Thomas, Windsor, Ont.
- Walker, James, Allan's Mills, Ont.  
 Wallace, A., Shubenacadie, N.S.  
 Wallace Bros., Woodbridge, Ont.  
 Walsh, Hugh, St. Andrews East, Q.  
 Walter, W. H., Brighton, Ont.  
 Ward, W., Churchville, Ont.  
 Wark, F., Lysander, Que.  
 Wasson, John, Warsaw, Ont.  
 Waterbury, J. P., New Glasgow, N.S.  
 Watson, Geo., Riverside, N.B.  
 Watson, R. M., Kincairdine, Ont.  
 Watson Bros., River de Chute, N.B.  
 Webb, R. G., Londesborough, Ont.  
 Weeks, J. P., Horning's Mills, Ont.  
 Weeks, F. W., Weston, Ont.  
 Weigand, H. E., Arthur, Ont.  
 Weir, John, New Glasgow, N.S.  
 Weir, William, River John, N.S.  
 Wenger, N., & Bros., Ayton, Ont.  
 West, Thomas B., Wallaceburg, Ont.  
 Wheeler, Bros., Cataract, Ont.  
 White, E. R., Orwell, Ont.  
 Whitelaw, Baird & Co., Paris, Ont.  
 Whyte, G. C., Galetta, Ont.  
 Whyte, J., Brighton, Ont.  
 Wile, Dean, Bridgewater, N.S.  
 Wilkinson, G., Buttonville, Ont.  
 Williamson & Crombie, Kingsbury, Q.  
 Willing, T., Martintown, Ont.  
 Wilson, G., Plevna, Ont.  
 Wilson, James, Fergus, Ont.  
 Wilson, James, Radford, Que.  
 Wilson, W., Springbrook, Ont.  
 Wilson Bros., Fordwich, Ont.  
 Wilson, Thomas & Son, Harriston, O.  
 Winkler Milling Co., Winkler, Man.  
 Wissler, J. R., Salem, Ont.  
 Wolseley Milling Co., Wolseley, [N.W.T.
- Wood, A. (Est. of), Smith's Falls, O.  
 Wood, W. B., St. George, Ont.  
 Wood, A., & Sons, Lakeville, N.S.  
 Wood Bros., Brantford, Ont.  
 Woodruff, H., Colebrook, Ont.  
 Woodruff, W., Odessa, Ont.  
 Wolverton (The) Milling Co., [Wolverton, Ont.
- Wright, Aaron, Clementsval, N.S.  
 Wright, H., Oakland, Ont.  
 Wright, W., Bradford, Ont.  
 Wright, John, & Sons, Owen Sound, [Ont.
- Wylie, James W., Almonte, Ont.  
 Young, C. H., Newcomb Mills, Ont.  
 Young, C., Young's Point, Ont.  
 Younie, J. A., (Est. of) Embro, Ont.

### MANUFACTURERS—Ironworking (and Machinist), Using Steam Power, Iron working Tools and Machinery.

(See also Boilers and Bridges in classified list).

- Abell, John, Engine & Machine Works [Co., Toronto, Ont.  
 Ahearn & Soper, Ottawa, Ont.  
 Aitken, James, & Sons, Alliston, Ont.  
 Aldred, Frederick, Glencoe, Ont.

GENERAL LIST OF CANADIAN MANUFACTURERS.

- Allan, J., Newmarket, Ont.  
 Allan, W. J. C., Kingston, Ont.  
 Allan Foundry & Machine Co.,  
 [St. John, N.B.  
 Amesse, P., Montreal, Que.  
 Anderson, R., & Co., Toronto, Ont.  
 Anderson & Murray, Oil Springs, O.  
 Arthur, James, & Son, New Glasgow,  
 [N.S.  
 Arnold, Alex., Cookstown, Ont.  
 Aspinall, Daniel, Montreal, Que.  
 Atkinson, J. W., Toronto, Ont.  
 Avey & Haines, Norwich, Ont.  
 Babcock, W., Odessa, Ont.  
 Babcock & Wilcox Co., (The),  
 [Montreal, Que.  
 Bain & Colville, Hamilton, Ont.  
 Baird, H. C., & Son, Park Hill, Ont.  
 Baldwin Iron Works, Ottawa, Ont.  
 Ballantine, John, & Co., Preston, Ont.  
 Ballard Electrical Works, Toronto, O.  
 Barber & Watson, Meaford, Ont.  
 Barnard Bros., Danville, Que.  
 Batchelder, H. L., Rock Island, Que.  
 Bateman, William, & Co., Montreal,  
 [Que.  
 Bates, James S., Smithville, Ont.  
 Bausch, Fred., Cote St. Paul, Que.  
 Beatty, M., & Sons, Welland, Ont.  
 Beauchemin & Fils, Sorel, Que.  
 Beaurivage, F., St. Nicholas, Que.  
 Beaver File Works Co., Levis, Que.  
 Bellefeuille & Co., St. Henri, Que.  
 Beliveau, H., & Co., St. Valere de  
 [Bulstrode, Que.  
 Bell, A., Dunneville, Ont.  
 Bell, George, Hamilton, Ont.  
 Bell, B., & Sons, St. George, Ont.  
 Bell, R., Jr., Hensall, Ont.  
 Benson, A. A., Montreal, Que.  
 Berg, A. M., Montreal, Que.  
 Bertrand, F. X., St. Hyacinthe, Que.  
 Bertrand, Chas., & Co., Isle Verte, Q.  
 Bertram Engine Works Co., Ltd.,  
 [Toronto, Ont.  
 Bertram, John, & Sons, Dundas, Ont.  
 Bessette, J. & S., Iberville, Que.  
 Binkley Bros., Neustadt, Ont.  
 Bissell, T., Prescott, Ont.  
 Black, L., & Co., Brockville, Ont.  
 Blenkinsopp, J. K., Pictou, N.S.  
 Blythe, C., London, Ont.  
 Blyth Mfg. Co., Blyth, Ont.  
 Body & Co., Hunterstown, Que.  
 Boyd, H., Montreal, Que.  
 Bradt, James J., Beamsville, Ont.  
 Brandon Machine Co., Brandon, Man.  
 British Columbia Iron Works Co.,  
 [Ltd., Vancouver, B.C.  
 Brodeur, P., St. Hugues, Que.  
 Brown (G. & J.) Co., Ltd., Belleville,  
 [Ont.  
 Brown, Boggs & Co., Hamilton, Ont.  
 Buchanan, M. T., Ingersoll, Ont.  
 Bunn, J. A., Cayuga, Ont.  
 Burlington Mfg. Co., Burlington, Ont.  
 Burrill, Johnson Iron Co., Ltd.,  
 [Yarmouth, N.S.  
 Burrow, Stewart & Milne, Hamilton,  
 Butler, Wm., Hamilton, Ont. [Ont.  
 Butterworth & Co., Ottawa, Ont.  
 Butterfield & Co., Rock Island, Que.  
 Callender, E. A., Merrickville, Ont.  
 Campbell, W. J., Ottawa, Ont.  
 Campbell Bros., St. John, N.B.  
 Canada Bolt & Latch Works,  
 [Montreal, Que.  
 Canada Screw Co., Hamilton, Ont.  
 Canada Switch & Spring Co.,  
 [Montreal, Que.  
 Canadian Bridge & Iron Co.,  
 [Montreal, Que.  
 Canadian General Electric (The)  
 [Peterboro', Ont.  
 Canadian Hollow Blast Grate Co.,  
 [Essex, Ont.  
 Canadian Locomotive & Engine Co.,  
 [Ltd., Kingston, Ont.  
 Cantin, E., Warwick, Que.  
 Cant Bros., Co., Ltd., (The) Galt, Ont.  
 Cape Breton Foundry & Machine Co.,  
 [Sydney, N.S.  
 Carey & Co., Montreal, Que.  
 Carrier, Laine & Co., Levis, Que.  
 Central Bridge & Engineering Co.,  
 [Ltd., Peterborough, Ont.  
 Chalifoux, O., & Fils, St. Hyacinthe,  
 [Que.  
 Chanteloup Mfg. Co., (The) Montreal,  
 Chapleau, G., Montreal, Que. [Que.  
 Charter & Rouse, Brantford, Ont.  
 Chaudiere Machine & Foundry Co.,  
 [(The) Ottawa, Ont.  
 Chesher, A., Georgetown, Ont.  
 Chisholm Bros., Oakville, Ont.  
 Clare Bros., & Co., Preston, Ont.  
 Clark, G. H., Ingersoll, Ont.  
 Clayson, Alfred, Toronto, Ont.  
 Cochrane Bros., St. Thomas, Ont.  
 Coghlin, B. J., & Co., Montreal, Que.  
 Coleman, T. T., (Est. of) Seaforth, O.  
**COLLINS MFG. CO. (The)—Fencing,  
 Barb Wire, Asbestos, Stove Pipe,  
 Thimbles, Stamped and Pieced  
 Tinware.**  
 Commire, N., Montreal, Que.  
 Connell Bros., Woodstock, N.B.  
 Consigny, N., Quebec, Que.  
 Copping, G. H., Toronto, Ont.  
 Copp Bros. Co., Ltd., (The) Hamilton,  
 [Ont.  
 Corbet, G., & Sons, Owen Sound, O.  
 Cortland Electric Mfg. Co., Ltd.,  
 [Toronto, Ont.  
 Cossitt Bros., Brockville, Ont.  
 Cote, Louis, & Frere, St. Hyacinthe,  
 [Que.  
 Coulthard, Scott & Co., Ltd., Oshawa,  
 [Ont.  
 Cowan & Co., Galt, Ont.  
 Crossman & Laws, Amherst, N.S.  
 Crowe, J., Guelph, Ont.  
 Currie, L., & Co., Ottawa, Ont.  
 Darling Bros., Montreal, Que.  
 Dashwood, Daniel, Dunville, Ont.  
 Date, John, Montreal, Que.  
 Delahey, T., Pembroke, Ont.  
 Dennis Iron & Wire Works, London,  
 [Ont.  
 Desnault & Fittes, Montreal, Que.  
 Desrosiers & Co., Louiseville, Que.  
 Devlin, C., & Son, Pembroke, Ont.  
 Diamond Machine & Tool Co., (The)  
 [Toronto, Ont.  
 Dick, W., Bolton, Ont.  
 Dickson, Bros., Campbellford, Ont.  
 Dobbin & Stuart, Thorold, Ont.  
 Doherty Mfg. Co., Sarnia, Ont.  
 Doig, A. E., & Co., Toronto, Ont.  
 Dominion Typograph Co., Windsor,  
 [Ont.  
 Donaldson, Robt., & Sons, Montreal,  
 Dore, J. B., & Sons, Laprairie, Que.  
 Downs, R., Clinton, Ont.  
 Down, Thos., & Co., Toronto, Ont.  
 Dowsell Bros., Hamilton, Ont.  
 Draper, T., Petrolea, Ont.  
 Drew George, Yamachiche, Que.  
 Drolet, F. X., Quebec, Que.  
 Drolet, Z., Quebec, Que.  
 Drouin, A., Pointe Gatineau, Que.  
**DRUMMONDVILLE FOUNDRY CO.  
 Drummondville, P.Q.—Agricul-  
 tural Implements of all kinds.  
 D. Hebert, Manager.**  
 Dubuc, F., Ange Gardien, Que.  
 Dunbar, Alex., & Sons, Woodstock,  
 [N.B.  
 Duncan & McLenan, Campbelltown,  
 [N.B.  
 Durand, Frs., Montreal, Que.  
 Durocher Bros., Cornwall, Ont.  
 Dussault & Lamoureux,  
 [St. Hyacinthe, Que.  
 Edgar, J., Chesley, Ont.  
 Elliott & Co., London, Ont.  
 Emerson & Campbell, Tweed, Ont.  
 Erie Iron Works Mfg. Co., St.  
 [Thomas, Ont.  
 Essex Brass & Iron Co., Ltd., Lon lon,  
 Evans, J., & Co., Omemece, Ont.  
 Favreau & Leblance, Montreal, Que.  
 Fee, John, Montreal, Que.  
 Feinberg, Louis, Montreal, Que.  
 Felix, Adolphe, Montreal, Que.  
 Fensom, John, Toronto, Ont.  
 Field, Charles, Toronto, Ont.  
 Findlay, Jas., Toronto, Ont.  
 Findlay Bros., Carleton Place, Ont.  
 Fisher, I. J., & Co., Kincardine, Ont.  
 Fleck, Alex., Jr., Ottawa, Ont.  
 Flemming, James, St. John, N.B.  
 Fletcher Mfg. Co., Toronto, Ont.  
 Fleurys, J., & Sons, Aurora, Ont.  
 Flindall Bros., Trenton, Ont.  
 Forbes Mfg. Co., Halifax, N.S.  
 Forest City Machine Works, London,  
 Fowler, Josiah, St. John, N.B. [Ont.  
 Fraser Bros., New Glasgow, N.S.  
 Frenet, H. F., Montreal, Que.  
 Frost & Wood, Smith's Falls, Ont.  
 Galloway, Taylor & Co., Toronto, O.  
 Gamache, Gabriel, Bic, Que.  
 Gananoque Spring & Axle Co.,  
 [Gananoque, Ont.  
 Gardiner, T., Newmarket, Ont.  
 Gardner, R., & Son, Montreal, Que.  
 Gardner, W. R., Tool Co., Brockville,  
 Garth & Co., Montreal, Que. [Ont.  
 Gauthier, G. P., St. George East, Que.



## GENERAL LIST OF CANADIAN MANUFACTURERS.

- Gilbert, Frank, Montreal, Que.  
 Gillies, Geo., Co., Ltd., (The)  
     [Gananoque, Ont.  
 Gillies, John, & Co., Carleton Place,  
     [Ont.  
 Gillies & Martin, Listowel, Ont.  
 Gill, Nap., Pierreville, Que.  
 Gilmore, G., Cote St. Paul, Que.  
 Globe File Co., Port Hope, Ont.  
 Gobert, T. N., Toronto, Ont.  
 Goldie & McCullough Co., Ltd., Galt,  
 Goodison, John, Sarnia, Ont. [Ont.  
 Goold Bicycle Co., Ltd., (The)  
     [Brantford, Ont.  
 Gordon, William, Montreal, Que.  
 Gould, J. H., Smith's Falls, Ont.  
 Gourdin, C., Montreal, Que.  
 Gowdy Mfg. Co., Guelph, Ont.  
 Gower & Co., Montreal, Que.  
 Gowlay & Son, Essex, Ont.  
 Graham, A., Campbellford, Ont.  
 Graham, A. T., & Co., New Glasgow,  
     [N.S.  
 Greenleaf & Son, Belleville, Ont.  
 Greey, Wm. & J.G., Toronto, Ont.  
 Grindell, H., Acton, Ont.  
 Grout, John H., & Co., Grimsby, Ont.  
 Guertin, J. E., South Casselman, Ont.  
 Gurney Foundry Co., Toronto, Ont.  
 Gurney Scale Co., Hamilton, Ont.  
 Gurney, Tilden & Co., Hamilton, O.  
 Haggas, Joseph, Uxbridge, Ont.  
 Halle, Nap., Louiseville, Que.  
 Hamel, C. A., St. Hyacinthe, Que.  
 Hamilton Brass Co., Hamilton, Ont.  
 Hamilton, Peter, Mfg. Co.,  
     [Peterborough, Ont.  
 Hamilton, Wm., Mfg. Co.,  
     [Peterborough, Ont.  
 Handley, W., Mount Pleasant, Ont.  
 Hanley, J. B., Midland, Ont.  
 Hantsport Foundry & Machine Co.,  
     [Ltd., Hantsport, N.S.  
 Harper, M., & Son, Whitby, Ont.  
 Harris, O., Kingsville, Ont.  
 Haskin, R. C., Phillippsville, Ont.  
 Hayden, T., Port Hope, Ont.  
 Hay, Peter, Galt, Ont.  
 Helm, J. H., Port Hope, Ont.  
 Henderson, C. L., Berlin, Ont.  
 Henderson, C. W., Montreal, Que.  
 Hergott & Hergott, Mildmay, Ont.  
 Herring, John, & Sons, Napanee, Ont.  
 Hills, J., & Son, Halifax, N.S.  
 Hocking, Thomas, Montreal, Que.  
 Hodge, S., Mitchell, Ont.  
 Holder, L. G., & Co., St. John, N.B.  
 Holmes & Holliday, Clarksburg, Ont.  
 Hopkinson, R. O., Waterville, Que.  
 Hoskins, S. J., & Son, Bowmanville,  
 Houston, M. L., Golden, B.C. [Ont.  
 Howard Furnace Co., (The) Berlin,  
     [Ont.  
 Howell, W. W., & Co., Halifax, N.S.  
 Howse, William, Sussex, N.B.  
 Hutchinson & Campbell, Toronto, O.  
 Huxtable & Courtney, Halifax, N.S.  
 Imbleau, L., Renfrew, Ont.  
 Ingersoll Rock Drill Co., Montreal, Q.  
 Inglis, John, & Sons, Toronto, Ont.
- Ives, H. R., & Co., Montreal, Que.  
 Jackson, Cochrane & Co., Berlin, Ont.  
 Jacques, F. X., St. Jean des  
     [Chaillons, Que.  
 James, C., Hamilton, Ont.  
 Jamieson & Murphy, Eganville, Ont.  
 Jardine, A. B., & Co., Hespeler, Ont.  
 Jaynes, W. H., Oshawa, Ont.  
 Jenckes Machine Co., Sherbrooke, Q.  
 Johnson, J., & Sons, Milton, Ont.  
 Johnston & McGregor, Smith's Falls,  
     [Ont.  
 Joliette Foundry Co., Joliette, Que.  
 Kalte & Poole, Port Elgin, Ont.  
 Karch, H. W., Hespeler, Ont.  
 Kay Electric Mfg. Co., Hamilton, O.  
 Keith, Fitzsimmons Co., Toronto, O.  
 Kemp Mfg. Co., Ltd., Toronto,  
 Kendall, G. H., & Co., Montreal, Q.  
 Kennedy, Wm., & Sons, Owen Sound,  
     [Ont.  
 Kerr Engine Co., Walkerville, Ont.  
 Kerr & Morgan, Montreal, Que.  
 Keys, Wm., Montreal, Que.  
 Kieffer Bros., Montreal, Que.  
 Killey-Beckett Engine Co., Hamilton,  
     [Ont.  
 Kimball, S. S., Montreal, Que.  
 King Bros., Dresden, Ont.  
 King, Warden, & Son, Montreal, Que.  
 Kingston Foundry & Machine Co.,  
     [Kingston, Ont.  
 Kirwin, C. A., Hamilton, Ont.  
 Knowles, Arthur, London, Ont.  
 Kurtz, J., Kurtzville, Ont.  
 Lafond, Alfred, Vancouver, B.C.  
 Laidlaw, A., & Co., Toronto, Ont.  
 Laing, Ritchie & Co., Essex, Ont.  
 Laliberte, D., St. Johns, Que.  
 Lamoureux, Roch, Sorel, Que.  
 Lancaster Machine Works, Lancaster,  
     [Ont.  
 Laporte, Nap., & Fils, Montreal, Que.  
 Lareau, J. Z., Farnham, Que.  
 Larmonth, John, & Co., Montreal, Q.  
 Laurie Engine Co., Montreal, Que.  
 Lawson, James, Montreal, Que.  
 Lawson, S. L., & Co., Amherst, N.S.  
 Lawson, Thos., Ottawa, Ont.  
 Learmonth, Alex., & Co., Quebec, Q.  
 Lebel & Dubrule, Montreal, Que.  
 Lee, Richard, Quebec, Que.  
 Lefebvre, E., St. Casimir, Que.  
 Leger, N., St. Isidore, Ont.  
 Legood, Jas., Toronto, Ont.  
 Legris & Co., Montreal, Que.  
 Leigh, G., & Son, Orono, Ont.  
 Leitch, J., Hamilton, Ont.  
 Leitch & Turnbull, Hamilton, Ont.  
 Leonard, E., & Sons, London, Ont.  
 Lewis & Sons, Truro, N.S.  
 Linotype Co., Montreal, Que.  
 Lloyd Mfg. & Foundry Co., Kentville,  
     [N.S.  
 Lockeport Iron Works, Lockeport,  
     [N.S.  
 London Electric Motor Co., London,  
     [Ont.  
 London Engine Supply Co., London,  
     [Ont.
- London Foundry Co., London, Ont.  
 Long & Thompson, Orillia, Ont.  
 Low, G., Ottawa, Ont.  
 Lunenburg Iron Co., Ltd.,  
     [Lunenburg, N.S.  
 Lunn, G. J., & Co., Montreal, Que.  
 McArthur, D., & Sons, Kenmore, O.  
 McAvity, L., & Sons, St. John, N.B.  
 McClary Mfg. Co., London, Ont.  
 McDermott, C. G., & Bro., St.  
     [Catharines, Ont.  
 McDonald & Allen, Kingston, Ont.  
 McDonald & Laberge, Athelstane, Q.  
 McDougall, John, Montreal, Que.  
 McDougall, J., & Co., Montreal, Que.  
 McDougall, R., & Co., Galt, Ont.  
 McFarlane Bros., Ottawa, Ont.  
 McFarlane, Thompson & Anderson,  
     [Fredericton, N.B.  
 McIntosh, Andrew, Montreal, Que.  
 McKee & Marwick, Petrolia, Ont.  
 McKenzie, Hugh, South Rawdon,  
     [N.S.  
 McKeough & Trotter, Chatham, Ont.  
 McKinnon, D., Embro, Ont.  
 McKinnon, Dash & Hardware Co.,  
     [Ltd., St. Catharines, Ont.  
 McKnight, Hugh, Toronto, Ont.  
 McLachlan, Dugald, & Sons, St. John,  
     [N.B.  
 McLatchie, J., Cardinal, Ont.  
 McLanghlan, J., Cannington, Ont.  
 McLean & Bulley, Toronto, Ont.  
 McMartin, J. A., & Co., Montreal, Q.  
 McMaster Mfg. Co., Ltd., (The)  
     [Orangeville, Ont.  
 McNeil, W. P., & Co., New Glasgow,  
     [N.S.  
 McPherson, Alex., Oxford, N.S.  
 McOut & McRae, Lachute Mills, Que.  
 MacDonald, J. K., Montreal, Que.  
 MacGregor, Gourlay & Co., Galt, O.  
 Mac Machine Co., Belleville, Ont.  
 Macdonald & Co., Halifax, N.S.  
 Mackenzie, D., St. Thomas, Ont.  
 Macpherson & Co., Fingal, Ont.  
 Macpherson, Hovey & Co., Clinton, O.  
 Maguire & Dryden, Toronto, Ont.  
 Mahoney, D., Cornwall, Ont.  
 Makins, J., Lindsay, Ont.  
 Malloch, Wm., & Co., London, Ont.  
 Mann, J. W., Mfg. Co., Ltd.,  
     [Brockville, Ont.  
 Martin, Jas., & Son, Toronto, Ont.  
 Martin Mfg. Co., Whitby, Ont.  
 Massey-Harris Co., Ltd., Toronto, O.  
 Matheson, I., & Co., New Glasgow,  
     [N.S.  
 Maxwell, David, & Sons, St. Mary's,  
     [Ont.  
 Mayo, W. S., Ottawa, Ont.  
 Mazurette, L. N., Montreal, Que.  
 Miller, James G., Chatham, N.B.  
 Miller Bros., & Toms, Montreal, Que.  
 Miller & Campbell, Alexandria, Ont.  
 Milton Iron Foundry, Yarmouth, N.S.  
 Mitchell, Alex., Montreal, Que.  
 Mitchell, C., Brantford, Ont.  
 Mitchell, Robt., & Co., Montreal, Q.  
 Monbleau, E., St. Johns, Que.



GENERAL LIST OF CANADIAN MANUFACTURERS.

- Montreal Car Wheel Co., Montreal, Q.  
 Montreal Rolling Mills Co., Montreal, [Que.  
 Moody, M., & Sons, Terrebonne, Que.  
 Morse, W. M., St. Thomas, Ont.  
 Morrison, G. C., Hamilton, Ont.  
 Morrison Brass Mfg. Co., (The Jas.), [Toronto, Ont.  
 Morrisette, Geo. E., Three Rivers, Q.  
 Morris, F. H., Sackville, N.B.  
 Morrow, John, Machine Screw Co., [Ingersoll, Ont.  
 Mottashead, C., London, Ont.  
 Mount Bros., Montreal, Que.  
 Mowry & Son, Gravenhurst, Ont.  
 Murray, James, Newcastle, N.B.  
 Murray, H., & Co., Exeter, Ont.  
 Myers, W. F., & J. W., St. John, N.B.  
 Nash, R. G., Morrisburg, Ont.  
 Neff Bros., Humberstone, Ont.  
 Ness, McLaren & Bate, Montreal, Q.  
 Newell, Augustus & Co., Toronto, O.  
 New Hamburg Mfg. Co., New [Hamburg, Ont.  
 New Warren Scale Co., (The) [Montreal, Que.  
 Nicholson, Robt., Montreal, Que.  
 Nie & Whitefield, Hamilton, Ont.  
 Nish, William, Montreal, Que.  
 Normand, A., Montmagny, Que.  
 Norsworthy, C., & Co., St. Thomas, [Ont.  
 Northey Mfg. Co., Ltd., Toronto, Ont.  
 Nova Scotia Steel & Iron Co., Ltd., [New Glasgow, N.S.  
 Noxon Bros. Mfg. Co., Ltd., [Ingersoll, Ont.  
 Oil Well Supply Co., Petrolia, Ont.  
 Ontario Engine & Machine Co., [Toronto, Ont.  
 Ontario Wind Engine & Pump Co., Ltd., (The) Toronto, Ont.  
 Ouellet, Francois, Ste. Anne de la [Pocatiere, Que.  
 Owens, R., Grand Valley, Ont.  
 Oxford Foundry & Machine Co., [Oxford, N.S.  
 Page, Charles, Montreal, Que.  
 Paris Electro Plating Co., Paris, O.  
 Paris Tool Mfg. Co., Ltd., (The) Paris, [Ont.  
 Parizeau, Stanislas, Montreal, Que.  
 Parker, J. O., & Co., Toronto, Ont.  
 Park Bros., Chatham, Ont.  
 Parmenter & Bullock, Gananoque, O.  
 Partridge Bros., North Sydney, N.S.  
 Paxton, Tate & Co., Port Perry, Ont.  
 Pearson, Alex., Ingersoll, Ont.  
 Pemberthy Injector Co., Windsor, O.  
 Pendrith, G. T., Toronto, Ont.  
 Pendrigh & Crawford, Yarmouth, [N.S.  
 Pepper, T., & Co., Guelph, Ont.  
 Perkins, A. E., Ottawa, Ont.  
 Perkins, G. W., Ottawa, Ont.  
 Perkins, John, Toronto, Ont.  
 Peterboro' Lock Co., Peterboro', Ont.  
 Peterson, N. C., & Son, Sarnia, Ont.  
 Pettener, B. J., Montreal, Que.  
 Phelan, J., Petrolia, Ont.  
 Phillips, Peter, Toronto, Ont.  
 Phillips, G. P., & Co., Rat Portage, O.  
 Picard, E., Quebec, Que.  
 Pictou Iron Foundry & Mfg. Co., Ltd. [Pictou, N.S.  
 Pilkey, C. J., Orillia, Ont.  
 Pineo, Geo. E., Berwick, N.S.  
 Pink, T., Pembroke, Ont.  
 Pipe, William, Montreal, Que.  
 Piper, N. L., & Son, Toronto, Ont.  
 Plante, H. E., Montreal, Que.  
 Plessisville Foundry Co., (The) [Plessisville, Que.  
 Plummer Bros., Bolton, Ont.  
 Polson Iron Works, Toronto, Ont.  
 Pontbriand & Bros., Sorel, Que.  
 Poole & Co., Toronto, Ont.  
 Potter, D., Elora, Ont.  
 Pratt Mfg. Co., Montreal, Que.  
 Proven, Jas. W., Oshawa, Ont.  
 Rand Rock Drill Co., Sherbrooke, Q.  
 Raymond, Charles, Guelph, Ont.  
 Record Foundry & Machine Co., [Moncton, N.B.  
 Reid, Thos., Hamilton, Ont.  
 Reid & McMath, Goderich, Ont.  
 Remillard & Co., Three Rivers, Que.  
 Richard, J. L., Quebec, Que.  
 Richardson & Webster, St. Mary's, O.  
 Rielly & Rudkins, Peterboro', Ont.  
 Ritz, C., & Co., New Hamburg, Ont.  
 Rixford, O. S., Mfg. Co., Bedford, Q.  
 Robb Engineering Co., Ltd., Amherst, [N.S.  
 Roberts, E. H., Toronto, Ont.  
 Robichaud, Jos., St. Perpetue, Que.  
 Rodden, Wm., & Co., Montreal, Que.  
 Ronald, J. D., Brussels, Ont.  
 Ross, J. H. & R., Aurora, Ont.  
 Royal Electric Co., (The) Montreal, Q.  
 St. Thomas Car Wheel Co., St. [Thomas, Ont.  
 Savard, Louis, Quebec, Que.  
 Sawyer & Massey Co., Ltd., (The) [Hamilton, Ont.  
 Scanlan, Thomas, Montreal, Que.  
 Schneider, A., & Co., Toronto, Ont.  
 Schofield, Richard, Toronto, Ont.  
 Scott, E. M., Ingersoll, Ont.  
 Scott Bros., Richmond, Que.  
 Scudder, W. S., Montreal, Que.  
 Sculthorpe, W. J., Port Hope, Ont.  
 Shantz, I. F., & Co., Berlin, Ont.  
 Shantz, P. E., Preston, Ont.  
 Sheldon, L. L., Aylmer, Ont.  
 Shepherd, E. G., Ottawa, Ont.  
 Sherbrooke Iron works (The) [Sherbrooke, Que.  
 Sicotte, Telesphore, Montreal, Que.  
 Simpson Bros., Montreal, Que.  
 Singer Mfg. Co., Montreal, Que.  
 Sissons, Thomas, St. Raymond, Que.  
 Skinner & Co., Gananoque, Ont.  
 Sleeper & Akhurst, Coaticooke, Que.  
 Sleeper, F. H., & Co., Coaticooke, Q.  
 Small & Fisher Co., Ltd., Woodstock, [N.B.  
 Smart (The James) Mfg. Co., [Brockville, Ont.  
 Spragg & Gray, Victoria, B.C.  
 Starr, John, & Son, Co., Halifax, [N.S.  
 Star Mfg. Co., Halifax, N.S.  
 Steel Harrow Co., New Glasgow, N.S.  
 Steels, Peter, Toronto, Ont.  
 Stephenson, E. S., & Co., St. John, N.B.  
 Stephenson Boiler Co., Petrolia, Ont.  
 Stevenson, Wm. M., Winnipeg, Man.  
 Stevens, Hamilton & Co., Galt, Ont.  
 Stevens, J., & Son, Toronto, Ont.  
 Stevens Mfg. Co., London, Ont.  
 Steward, A., Kincardine, Ont.  
 Stewart, Bruce, Charlottetown, P.E.I.  
 Stewart, John, New Glasgow, N.S.  
 Stickney, E., Newburg, Ont.  
 Stratford Bridge & Iron Works Co., [Stratford, Ont.  
 Strong, G., Harriston, Ont.  
 Stuart & Harper, Winnipeg, Man.  
 Sutton, W. P., Toronto, Ont.  
 Star Iron Co., (The) Montreal, Que.  
 Sylvester Bros. Mfg. Co., Lindsay, O.  
 Tardiff, John, Plessisville, Que.  
 Taylor, J. & J., Toronto, Ont.  
 Thompson, Joseph, St. John, N.B.  
 Thompson, R., & Son, Montreal, Que.  
 Three Rivers Iron Works, Three [Rivers, Que.  
 Thring, Frederick S., Toronto, Ont.  
 Tolton Bros., Guelph, Ont.  
 Toronto Electric Motor Co., Toronto, [Ont.  
 Toronto Electrical Wrks, Toronto, O.  
 Toronto Foundry Co., Toronto, Ont.  
 Toronto Hardware Mfg. Co., Toronto, [Ont.  
 Toronto Radiator Mfg. Co., Toronto, [Ont.  
 Toronto Steel Clad Bath & Metal Co., [Ltd., Toronto, Ont.  
 Toupin, C., & Fils, Montreal, Que.  
 Trott, Vincent, Toronto, Ont.  
 Turner, John, & Son, Toronto, Ont.  
 Turville, D., Ingersoll, Ont.  
 Valleyfield Foundry & Mach. Works, [Valleyfield, Que.  
 Vessot, S., & Co., Joliette, Que.  
 Victoria Foundry & Machine Shops, [Ottawa, Ont.  
 Vidal Fils, & Cie, Quebec, Que.  
**VIVIAN, J. H., Toronto, Ont. —  
 Printing Presses and Printers'  
 Supplies.**  
 Walker Co.'y (The) Belleville, Ont.  
 Waring, White & Co., St. John, N.B.  
 Waterloo Mfg. Co., Waterloo, Ont.  
 Waterhouse Engine Works Co., Ltd., [Brantford, Ont.  
 Watson Bros., Ridgeway, Ont.  
 Watt Bros., Gananoque, Ont.  
 Watt, Thomas, & Son, Lanark, Ont.  
 Webster, Geo., Hamilton, Ont.  
 Weddell, R., Trenton, Ont.  
 Welland Vale Mfg. Co., St. [Catharines, Ont.  
 Wells, George, Montreal, Que.  
 Weir, J. & R., Montreal, Que.  
 Weir & Morrison, Westville, Ont.  
 Westman & Baker, Toronto, Ont.  
 West & Peachy, Simcoe, Ont.  
 Whelpley, J. A., & Co., Greenwich [Hill, N.B.

## GENERAL LIST OF CANADIAN MANUFACTURERS.

Whitelaw, R., Woodstock, Ont.  
 Whiting, A. S., Mfg. Co., Cedar Dale, [Ont.  
 Whitman & Barnes Mfg. Co., St. [Catharines, Ont.  
 Whitney, J., Prescott, Ont.  
 Whitney Electrical Instrument Co.  
 White, Robt. C., Montreal, Que.  
 White, George, & Sons, London, Ont.  
 Wilcox, Geo., Berlin, Ont.  
 Williams, A. R., Toronto, Ont.  
 Wills, George, Montreal, Que.  
 Wilson, James, Merriton, Ont.  
 Wilson, Wm. C., Toronto, Ont.  
 Wilson, F. H., & Co., Yarmouth, N.S.  
 Wilson, J. C., & Co., Glenora, Ont.  
 Wilson & Cousins, Toronto, Ont.  
 Wilson's Iron Works, Dundalk, Ont.  
 Winckler, Julius, Hamilton, Ont.  
 Windsor Foundry Co., Windsor, N.S.  
 Winnett, E., & Son, London, Ont.  
 Woodlan, S., Smithville, Ont.  
 Woodyatt, A. R., & Co., Guelph, Ont.  
 Woon, Robert, & Co., Oshawa, Ont.  
 Worthing, Henry, Toronto, Ont.  
 Wortman & Ward Mfg. Co., London, [Ont.  
 Wren, A., & Co., Forest, Ont.  
 Wright & Cunningham, St. [Catharines, Ont.  
 Wythe, Wm., Toronto, Ont.  
 Young, Andrew, Montreal, Que.  
 Young Bros., Almonte, Ont.  
 Young & Bro., Co., Ltd., (The) [Brampton, Ont.

### MANUFACTURERS. — Leather

Acton Tanning Co., Acton, Ont.  
 Adams, J. R., Teeswater, Ont.  
 Adams & Fox, Teeswater, Ont.  
 Aikens, G. & J., Orangeville, Ont.  
 Alaire, C., Rochelle, Que.  
 Allaire, D., St. Jerome, Que.  
 Allaire, U., Quebec, Que.  
 Alexander, D. W., & Co., Toronto, O.  
 Allen, John J., North Sydney, N.S.  
 Allen, J. & J., Thornbury, Ont.  
 Archibald, J. W., Baddeck, N.S.  
 Archibald, S., & Sons, Truro, N.S.  
 Argue, George, Ashton, Ont.  
 Arscott, John, Walkerton, Ont.  
 Arscott, S., & Co., Benton, N.B.  
 Arscotts & Son, Walkerton, Ont.  
 Asselin, I., St. Alphonse, Que.  
 Aubry, E., St. Sauveur des Mon- [tagues, Que.  
 Auger, Ed., St. Paul de Chester, Que.  
 Ayer, D. J., Moe's River, Que.  
 Ayre, James R., Sackville, N.B.  
 Baker, Nelson, Fournier, Ont.  
 Balcer, Henry M., Three Rivers, Que.  
 Baribeau, E., St. Casimir, Que.  
 Barrie Tanning Co., Ltd., Barrie, O.  
 Beauchamp, A., Ste. Therese, Que.  
 Beaudet, D., Lotbiniere, Que.  
 Beaudet, U., St. Lambert, Que.  
 Beaulne, L., St. Augustin, Que.  
 Beauregard, P., St. Simon, Que.  
 Beck, J., Saltford, Ont.

Begin, D., Levis, Que.  
 Begin, R., Etchemin, Que.  
 Begin, Lemieux & Co., Sherbrooke, [Que.  
 Belanger, P., Clarence Creek, Ont.  
 Belding, H., Hampton, N.B.  
 Bergeron, Felix, St. Barnabe, Que.  
 Bergevin, Geo., Ste. Martin, Que.  
 Bigaouette, P., Ruisseau Le Blanc, [Que.  
 Blais, Wilbrod, Quebec, Que.  
 Blanchard, E., L'Epiphanie, Que.  
 Blouin, Jos., Ste. Marie, Que.  
 Blouin, J. B., & Fils, Levis, Que.  
 Bone, James, Paisley, Ont.  
 Boucher, Jos., St. Paschal, Que.  
 Bourassa, Arthur, Village des Aul- [nais, Que.  
 Bourassa, F., Three Rivers, Que.  
 Bourassa, Geo., La Baie, Que.  
 Bower, Ed. A., Shelburne, N.S.  
 Bowman & Zinkan, Southampton, O.  
 Breithaupt Leather Co., Ltd., Berlin, [Ont.  
 Breithaupt Leather Co., Ltd., (The) [Listowel, Ont.  
 Brennan, John, Chesley, Ont.  
 Brien, F., Mascouche, Que.  
 Briethaupt Bros., & Hall, [Penetanguishene, Ont.  
 Briggs, G. W., Eganville, Ont.  
 Brodeur, H., St. Damase, Que.  
 Brown, John, St. Agapit, Que.  
 Brown & Erb, Berlin, Ont.  
 Brown, Thomas & Son, Ingersoll, O.  
 Brydon & McKenzie, Dundalk, Ont.  
 Burnet, W. G., Galt, Ont.  
 Canada Leather Co., Montreal, Que.  
 Canada Leather Co., Quebec, Que.  
 Cantin & Bresse, Quebec, Que.  
 Cardinal, M., Ste. Martin, Que.  
 Cardinal, Nap., St. Ephrem D'Upton, [Que.  
 Caron, A., L'Islet, Que.  
 Caron, A., L'Islet, Que.  
 Caron, P., L'Islet, Que.  
 Carrier, F., St. Polycarpe, Que.  
 Carrington, Joseph, Kingston, Ont.  
 Carson & Perry, Meaford, Ont.  
 Casey, W. H. A., Harvey, N.B.  
 Casey, C. R., & Son, Amherst, N.S.  
 Cauchon, Philippe, Murray Bay, Que.  
 Champagne, L., Joliette, Que.  
 Charlesbois, N., Alfred, Ont.  
 Charpentier, A., L'Avenir, Que.  
 Chenier, G., Plantagenet, Ont.  
 Chevalier, P., St. David, Que.  
 Claude, Pierre, Montreal, Que.  
 Clement, M., & Co., Quebec, Que.  
 Clermont, H., Ste. Elizabeth, Que.  
 Coleman, Anson, Delta, Ont.  
 Comtois, Z., Ste. Hugues, Que.  
 Cote, Ed., Chateau Richer, Que.  
 Cote, Elzear, Quebec, Que.  
 Courtney, E., Mount Pleasant, Ont.  
 Courtney, J. W., Newburgh, Ont.  
 Cox, William S., Truro, N.S.  
 Craig, W., & Son, Port Hope, Ont.  
 Cullen & Couchon, Carleton, Que.  
 Currie, Daniel, St. Peters, N.S.  
 Danis, M., Cummings Bridge, Ont.

Daunais, T., Terrebonne, Que.  
 Daville Tanning Co., Ltd., Aurora, [Ont.  
 Davis, A., & Son, Kinghorn, Ont.  
 Dawson, John, Dickinson's Landing, [Ont.  
 Dechman, A., & Son, Sherbrooke, [N.S.  
 Decotea, L., Grand St. Esprit, Que.  
 Deguise, C., Three Rivers, Que.  
 Delaire, M., St. Raphael, Que.  
 Delorme, Jos., St. Jude, Que.  
 Demers, N., Ste. Justine de Newton, [Que.  
 D'Entremont & Surett, Pubinco, N.S.  
 Desgagne, Nap., St. Paschal, Que.  
 Des Jardins, J., St. Jovite, Que.  
 Desmarais, A., St. Pie, Que.  
 Desrosiers, A., MacNider, Que.  
 Deveault, E., Lambton, Que.  
 Devlin, C. & A., Perth, Ont.  
 Dickenson, John H., Hartland, N.B.  
 Dionne, Pierre, St. Alexandre, Que.  
 Dionne, P., St. Philippe de Nery, Q.  
 Doyle, M. A., Milford, N.S.  
 Duclos & Payan, Berthier, Que.  
 Duclos & Payan, St. Hyacinthe, Que.  
 Dugal, J. A., Quebec, Que.  
 Dugal, Mrs. Pierre, Quebec, Que.  
 Dugal & Duguay, Fraserville, Que.  
 Duguay, Jos. O., Terrebonne, Que.  
 Duhamel, Phillipe, Sorel, Que.  
 Dunn Bros., Stanbridge East, Que.  
 Duplessis, E., Quebec, Que.  
 Durkee, M., Otterville, Ont.  
 Duval, P., Ste. Tite, Que.  
 Ecrovd, Thos., Montreal, Que.  
 Eglin, R., & Son, Dresden, Ont.  
 Etherington, R. P., Gunning Cove, [N.S.  
 Falardeau, P. E., & Co., Quebec, Q.  
 Farmer, W. & R., Ottawa, Ont.  
 Fisk, H. J., & Co., Montreal and [Quebec, Que.  
 Fitzpatrick, Michael, Port Elgin, [N.B.  
 Fitzgerald, D., & Son, Glassville, [N.B.  
 Flanigan, P., & Son, Hanover, Ont.  
 Flummerfelt, H., & Co., St. [Catharines, Ont.  
 Foley, Thomas, & Son, Collingwood, [Ont.  
 Forest, C., Pont Chateau, Que.  
 Fortier, Jos., St. Hermas, Que.  
 Fortier, Nazaire, Quebec, Que.  
 Fortin, S., Napierville, Que.  
 Foster, A., Pembroke, Ont.  
 Foulds, John, Matintown, Ont.  
 Fournier, E., Cap St. Ignace, Que.  
 Fournier, T., MacNider, Que.  
 Fowler & Lowry, Peticodiac, N.B.  
 Francis, Isaac, Acton, Ont.  
 Fraser, S., Lochinvar, Ont.  
 Freeman, R., Alliston, Ont.  
 Gagner, E., St. Victor de Tring, Que.  
 Gagnon, B., Sr., West Broughton, Q.  
 Gagnon, M., Victoriaville, Que.  
 Gagnon, Achille, & Co., Victoriaville, [Que.

GENERAL LIST OF CANADIAN MANUFACTURERS.

- Galway, Wm. J., Warden, Que.  
 Garant & Blouin, Ste. Marie, Que.  
 Gaud, W. H., Hillsburg, Ont.  
 Galarneau, T., St. Timothe, Que.  
 Gauthier, E., Roberval, Que.  
 Gauthier, E., St. Maurice, Que.  
 Gauthier, P. J., Chicoutimi, Que.  
 Gauthier, P., St. Stanislas, Que.  
 Germain & Morency, Quebec, Que.  
 Godin, Jos., Cote des Neiges, Que.  
 Goodhue, J. L., & Co., Danville, Que.  
 Goodwin, J. H., & Co., Point du  
 [Bute, N.B.  
 Gourdeau, Felix, & Frere, Quebec,  
 Graef, F. W., Clifford, Ont. [Que.  
 Graham, J. & J., Roger's Hill, N.S.  
 Grant, J. & T., Woodstock, Ont.  
 Grant, T., & Sons, Eureka, N.S.  
 Grant, Thos., & Son, Riverton, N.S.  
 Gravel, H., Drummondville, Que.  
 Gravelle, L., St. Eustache, Que.  
 Guay, D., Quebec, Que.  
 Hall, Henry C., Stanbridge East, Q.  
 Hall, Robert, L'Orignal, Ont.  
 Heldman, Bros., Baden, Ont.  
 Helson, G. A., Peterboro', Ont.  
 Hempell, W., Richmond, Ont.  
 Henrichon, Nap., Montreal, Que.  
 Hetherington, Jas. G., & Son,  
 [Starkeys, N.B.  
 Hoff & Roedler, Milton, Ont.  
 Holland, W., Sr., Park Hill, Ont.  
 Hyman, C. S., & Co., London, Ont.  
 Ingraham, Sanford, Middle Simonds,  
 [N.B.  
 Jacobs, Thos., Smith's Falls, Ont.  
 James, C. C., Priceville, Ont.  
 Jean, F., Chicoutimi, Que.  
 Jodoin, Joseph, Ste. Madeleine, Que.  
 Joly, Jos., St. Gabriel de Brandon,  
 [Que.  
 Journeay, L., Weymouth Bridge,  
 Julien & Guay, Quebec, Que. [N.S.  
 Justras, F. E., & Co., Stanfold, Que.  
 Kennedy, Angus, Alexandria, Ont.  
 King Bros., Whitby, Ont.  
 Kinghorn, Wm., Nashwaaksis, N.B.  
 Knees, Chas., Oshawa, Ont.  
 Knight & Dey, Napanee, Ont.  
 Laberge, I., & Co., Ste. Martin, Que.  
 Labrecque, F., Quebec, Que.  
 Lacasse, Jos., St. Bernard, Que.  
 Laframboise, M., Ste. Scholastique,  
 [Que.  
 Lajoie, Jos., Ste. Anne de la Perade,  
 [Que.  
 Lamb, John L., Omemee, Ont.  
 Lamothe & Co., Quebec, Que.  
 Landry, M., Laurentides, Que.  
 Lang Tanning Co., Ltd., (The)  
 [Berlin, Ont.  
 Langlois, Louis, St. Raphael, Que.  
 Lapointe, Francois Xavier, Sr.,  
 [Quebec, Que.  
 Laporte, Jos., Ste. Scholastique, Que.  
 Lassalle, F. X., St. Antoine Abbey,  
 [Que.  
 Lauchlin & Robson, Oshawa, Ont.  
 Laurent, Ed., Louiseville, Que.  
 Lavallee, F. X., St. Eugene, Ont.  
 Laverdure, Jos., Laurentides, Que.  
 Lavigne, J. Bte., Ste. Placide, Que.  
 Lawry, C., Dundas, Ont.  
 Lawson, Peter, Port Dover, Ont.  
 Lebeau, Chas., & Co., Ste. Brigide,  
 [Que.  
 Leblance, G., Ste. Genevieve, Que.  
 Leclerc, Ed., St. Paul de Chester, Q.  
 Leduc, Leon, Sorel, Que.  
 Lemieux, Ed., Montmagny, Que.  
 Lemieux, F., Matane, Que.  
 Lemieux, Noel, Matane, Que.  
 Lemieux, N., Montmagny, Que.  
 Lemieux, O., St. Francois North  
 [East, Que.  
 Lisle, Alfred, Lindsay, Ont.  
 Lowe, W. A., Robinson, Que.  
 Lucy, R., Drayton, Ont.  
 Lussier, H., St. Edouard, Que.  
 Lynch, Anthony, St. Johns, Que.  
 McClinton, G. G., Pakenham, Ont.  
 McConnell, Geo., River John, N.S.  
 McCordick, W. H., St. Catharines, O.  
 McDonald & Grant, S. Lancaster, O.  
 McHeffey, F. P., Shubenacadie, N.S.  
 McIntosh, Jas. W., Goshen, N.S.  
 McKeen, L. S., & Co., Whyccomagh,  
 [N.S.  
 McKinn, James, Whyccomagh, N.S.  
 McKinnon, J., Whyccomagh, N.S.  
 McLean, John, & Sons, Hopewell,  
 McPhail, M., Thurso, Que. [ N.S.  
 McQuay, George, Owen Sound, Ont.  
 Mageau, U., Ste. Julie, Que.  
 Maille, T. Bte., St. Augustin, Que.  
 Main, W., Kemptville, Ont.  
 Malepart, Jos., Varennes, Que.  
 Marchand, O., St. Cuthbert, Que.  
 Marcotte, Arthur, Portneuf, Que.  
 Marlatt & Armstrong, Oakville, Ont.  
 Martin, Francois, Three Rivers, Que.  
 Mason, Wm., & Sons, Dundas, Ont.  
 Matte, Francois X., St. Francois du  
 [Lac, Que.  
 Maye, William, St. Cuthbert, Que.  
 Mayer, A., St. Philippe D'Argenteuil,  
 [Que.  
 Mayer, Nap., St. Barthelemi, Que.  
 May & Foster, Ottawa, Ont.  
 Melancon, I., St. David, Que.  
 Melancon, Z., St. Guillaume d'Upton,  
 [Que.  
 Mercure, Francois, St. Cesaire, Que.  
 Millar, C. J., Orillia, Ont.  
 Miller Bro., Mount Albert, Ont.  
 Miner, S. H. C., Granby, Que.  
 Mitigny, A., Ste. Marie de Monnoir,  
 [Que.  
 Moir, Jas. G., Mount Whatley, N.B.  
 Mongeau, A., Vercheres, Que.  
 Montgomery, J., Kars, Ont.  
 Mooney, James, Durham, Que.  
 Moore, Henry, South Mountain, Ont.  
 Moore, William, Iroquois, Ont.  
 Morasse, Adolphe, Pont Rouge, Que.  
 Moras, Jos., Cap Sante, Que.  
 Morency, C., Riviere Trois Pistoles,  
 Morency, G., Quebec, Que. [Que.  
 Morency, I., Ste. Anne de la Perade,  
 [Que.  
 Morin, Jos., L'Epiphanie, Que.  
 Morin & Frere, Quebec, Que.  
 Morris, James, Russell, Ont.  
 Morton, Forman, New Germany, N.S.  
 Moseley, E. Frank, & Co., Montreal,  
 [Que.  
 Muskoka Leather Co., Bracebridge,  
 [Ont.  
 Nantel, T., Ste. Rose, Que.  
 Newton Bros., Richmond Hill, Ont.  
 Nicklin & Smith, Georgetown, Ont.  
 Ott, John, Brantford, Ont.  
 Palmer, J., Fredericton, N.B.  
 Paquet, C., Lachevrotiere, Que.  
 Parker, W. A., Shubenacadie, N.S.  
 Parsons & Duncan, Beaverton, Ont.  
 Patenaude, E., St. Damase, Que.  
 Patterson, Walter, & Son, Peter-  
 [borough, Ont.  
 Pelletier, E., Ste. Anne de la Poca-  
 [tiere, Que.  
 Pepin & Co., Shefford Mountain, Q.  
 Peters, Chas. H., St. John, N.B.  
 Peters, Wm., St. John, N.B.  
 Picard, Chas., Cap St. Ignace, Que.  
 Pion, A., & Co., Quebec, Que.  
 Plamondon, Jos., Quebec, Que.  
 Poisson, Jos., Plessisville, Que.  
 Poliquin, Mrs. H., Quebec, Que.  
 Poliquin, L., Lavaltrie, Que.  
 Poliquin, P., Lavaltrie, Que.  
 Porter, Henry, Montreal, Que.  
 Pouliot, A., & Co., Quebec, Que.  
 Pouliot, J. & S., & Bro., Quebec, Q.  
 Quemineur, C., St. Charles, Que.  
 Rhuland, Jacob, Mahone Bay, N.S.  
 Richardson, Thos. R., Warwick, Que.  
 Richer, M., St. Andre Avelin, Que.  
 Robbins, G. W., Yarmouth, N.S.  
 Robichaud, P. L., Metaghan, N.S.  
 Robinet, Francois, Quebec, Que.  
 Robson, T., Lindsay, Ont.  
 Rochette, C., Quebec, Que.  
 Rochette, Emile, Pierreville, Que.  
 Rochette, F., Quebec, Que.  
 Rochette, Gaspard, Quebec, Que.  
 Rochon, Maxime, St. Benoit, Que.  
 Rodrigue, Nap., St. Ephrem de  
 [Tring, Que.  
 Rousseau, James, New Westminster,  
 [B.C.  
 Roussin, D., Cedars, Que.  
 Roussin & Dennis, Glen Robertson,  
 [Ont.  
 Sale & Marlatt, Oakville, Ont.  
 Schaffner, Leonard, Middleton, N.S.  
 Scott, John (Estate of) St.  
 [Catharines, Ont.  
 Scott, M. W., Westport, Ont.  
 Sellery, R., Kincardine, Ont.  
 Shaver, Albert, Port Dover, Ont.  
 Shaw & Boyer, Hartland, N.B.  
 Shooner, Denis, Pierreville, Que.  
 Simard, Francois, Ste. Anne de  
 [Beaupre, Que.  
 Simard, I., Ste. Agathe, Que.  
 Sims, E., Agathe, Que.  
 Sims, E., Alliston, Ont.

GENERAL LIST OF CANADIAN MANUFACTURERS.

Sinclair, C. A., Shelburne, Ont.  
 Smith, Thomas, Durham, Ont.  
 Smith, F. & A., Goderich, Ont.  
 Sovereign, Jacob, Delhi, Ont.  
 Steel, James, Alton, Ont.  
 Stewart, James, Pugwash, N.S.  
 Stroh, Jacob G., Waterloo, Ont.  
 Stroud, A., & Son, Galt, Ont.  
 Stroud, A., & Son, Hamilton, Ont.  
 Tanner, J., & Sons, Hawkesville, O.  
 Tasse, L., Cote des Neiges, Que.  
 Tasse, O., Cote des Neiges, Que.  
 Therrien, Moise, Ste. Anne des  
 [Plaines, Que.  
 Thomson, Wm., & Son, Orono, Ont.  
 Thomson, Robt., Howick, Que.  
 Toby, Warren & Co., Collingwood, O.  
 Todd & Hass, Meaford, Ont.  
 Tremblay, H., Murray Bay, Que.  
 Turgeon, Elie, Quebec, Que.  
 Turgeon, F., Lyster, Que.  
 Viditoe, Mervin, Nictaux, N.S.  
 Valliere & Maranda, Quebec, Que.  
 Valiquette, A., Cumming's Bridge,  
 [Ont.  
 Wagner, T. J., Drayton, Ont.  
 Wainwright, S., Orillia, Ont.  
 Walker, J., Lanark, Ont.  
 Weinert, John, Neustadt, Ont.  
 Weldon, R. C., Penobsquis, N.B.  
 Welsh, John, & Co., Hastings, Ont.  
 Wilson, John, Farnham, Que.  
 Wilson, Thomas, Carp, Ont.  
 Wingham Tanning Co., Wingham, O.  
 Wood, F. H., Halifax South, Que.  
 Woods, Thos. W., Lambton, Que.  
 Wright, U., Stirling, Ont.

MANUFACTURERS.—Lumber.

(See also Shingle, Staves, Heading and  
 Baskets, in classified list).

Abray, W., Dentfield, Ont.  
 Ackert, J. H., Holyrood, Ont.  
 Adams, Alex., Muniac, N.B.  
 Adams, Charles, Lime Bridge, Que.  
 Adams, Chas. H., Marbleton, Que.  
 Adams, D. F., Victoria, B.C.  
 Adam, Nap., Paquetteville, Que.  
 Adam, Wm., Wickham West, Que.  
 Agagnier, Jos., St. Malo, Que.  
 Aitcheson, James, Avonton, Ont.  
 Aldrieve, John, Glencoe, Ont.  
 Alguire & Sutherland, Osnabruck, O.  
 Allaire, A., St. Cyrville, Que.  
 Allan, A. H., Marlbank, Ont.  
 Allan, G. H., & Co., Lake Weedon, Q.  
 Allan, John, Kinnear's Mills, Que.  
 Allan, R. & W., McLaren's Depot, O.  
 Allan, W. & R., Snow Road, Ont.  
 Allard, Nap., Cheneville, Que.  
 Allard, O., St. Gabriel de Brandon, Q.  
 Allard & Painchaud, French Village,  
 Allen, W., Farewell, Ont.  
 Allen, W., Perth, Ont.  
 Allin, W., Kirby, Ont.  
 Amey, Peter, Perth Road, Ont.  
 Anderson, W. E., Sundbridge, Ont.  
 Anderson, R., & Son, Waverley, O.

Anderson, Jas., & Sons, Dorchester,  
 [N.B.  
 Anderson, N., Hemmingford, Que.  
 Andrews, J. W. & J., Church Point,  
 [N.B.  
 Anglin, S., & Co., Kingston, Ont.  
 Annand, Arthur, Gay's River, N.S.  
 Annand, John, Oakfield, N.S.  
 Annis Bros., Carleton, N.S.  
 Appleyard, F., Chemin Tache, Que.  
 Arcand Bros., Champlain, Que.  
 Archambault, A., Contrecoeur, Que.  
 Archambault & Co., St. Michel des  
 [Saints, Que.  
 Archibald, Jos., Bedford, N.S.  
 Armstrong, J. S., Shawville, Que.  
 Armstrong, Michael, St. Odilon de  
 [Cranbourne, Que.  
 Armstrong, S. S., & Co., St. Odilon  
 [de Cranbourne, Que.  
 Arseneau, A., St. Wincelas, Que.  
 Arseneau, S., St. Wincelas, Que.  
 Ashby, C., Havelock, Ont.  
 Ashman, M., Rebecca, Ont.  
 Asman, Louis, Allenford, Ont.  
 Astle, Wm., Bros. & Co., Little Metis,  
 [Que.  
 Atkinson, James, Cashmere, Ont.  
 Atkinson, Henry, Etcehmin, Que.  
 Atwell, William, Rutherford, Ont.  
 Aubert, A., St. Alexandre, Que.  
 Audet A., St. Ephrem de Tring, Que.  
 Auger, H. G., St. Ubalde, Que.  
 Austin, F., Haliburton, Ont.  
 Avard, William, Great Shemogue,  
 Avey, F. C., Norwich, Ont. [N.B.  
 Babcock, B., Yarker, Ont.  
 Baker, D., Uththoff, Ont.  
 Balcomb, Herman, Vienna, Ont.  
 Barrett Bros., Trout Creek, Ont.  
 Baxter, Hugh, Sturgeon Falls, Ont.  
 Barabe, L., Ste. Sophie de Levrard,  
 [Que.  
 Barabe & Mailhoit, St. Jean des  
 [Chailions, Que.  
 Barber, Wm., Shawville, Que.  
 Baril, F., Warwick, Que.  
 Baril, Thos., St. Albert, Que.  
 Barkley, H. & C., Boucks Hill, Ont.  
 Barnecutt, J., Manvers Station, Ont.  
 Barnes, W. G., Green River, Ont.  
 Barnhill, B. B., Two Rivers, N.S.  
 Barnhill, Geo. E., St. John, N.B.  
 Barrette & Chretien, St. Gabriel de  
 [Brandon, Que.  
 Barron Bay Lumber Co., Wiarton, O.  
 Barr, J. B., Moonstone, Ont.  
 Barr, James, Covey Hill, Que.  
 Barr, S., Covey Hill, Que.  
 Barry, J., Nobleton, Ont.  
 Barry Bros., Pictou, N.S.  
 Basinet, Chas., St. Jean de Matha, Q.  
 Battick, C. W., & Son, Byng Inlet,  
 Baule, A., Lambton, Que. [Ont.  
 Bayley, Ed., Binbrook, Ont.  
 Razinet, D., St. Hughes, Que.  
 Baxter, Andrew, Maniwaki, Que.  
 Bachand, Francois, Roxton Pond, Q.  
 Bachand, J., Roxton Pond, Que.  
 Bachant, E., Rougemont, Que.  
 Bachlet, C., Kinloss, Ont.

Baechler, Louis, Milverton, Ont.  
 Baechler, M. & C., Benmiller, Ont.  
 Baechler, X., Jr., Sheppardton, Ont.  
 Baillie, W. & J., Aylmer, Que.  
 Baird, H., Lauriston, Ont.  
 Baker, F., Dashwood, Ont.  
 Baker Lumber Co., Gravenhurst, O.  
 Baker Bros., St. Nicholas, Que.  
 Balderson, Robt., Perth, Ont.  
 Bale, John, Rodney, Ont.  
 Ballagh, William F., Allenford, Ont.  
 Ball, George, Nicolet, Que.  
 Balton, W. R., Portland, Ont.  
 Baptist, Alexander, Three Rivers, Q.  
 Beach, M. F., & Co., Winchester, O.  
 Beaty, H., Balgrave, Ont.  
 Beauchemin & Freres, Pierreville, Q.  
 Beaudet, F. X., Fortierville, Que.  
 Beaudet, S., Fortierville, Que.  
 Beaudoin, F. X., St. Isidore, Que.  
 Beaudoin, L., Thefford Mines, Que.  
 Beaudoin, O., Ste. Agathe, Que.  
 Beaudoin, P., Scott Junction, Que.  
 Beaudry, T., St. Beatrix, Que.  
 Beaulieu, A., St. Modeste, Que.  
 Beaulieu, D., Tessierville, Que.  
 Bergeron, H., St. Agapit, Que. [Ont.  
 Bergeron, L., St. Clotilde de Horton,  
 Bernard, F., St. Fe-licien, Q. [Que.  
 Bernard, Geo., Riviere Bois Clare, Q.  
 Bernier, A., Grand Piles, Que.  
 Bertrand, G., Plessisville, Que.  
 Bertrand, L. A., Isle Verte, Que.  
 Betts, Chas., Ruscomb Station, Ont.  
 Beard, Bros., Douglastown, Que.  
 Bearman, J., Scone, Ont.  
 Bearman, Thos., Scone, Ont.  
 Beathy, W., Ballyroy, Ont.  
 Beattie, R., Lemesurier, Que.  
 Beatty, B., Hockley, Ont.  
 Beck, C., Mfg. Co., Penetanguishene,  
 Bedard, Joseph, Richmond, Ont.  
 Bedard Bro., Clarendon, Ont.  
 Beemer, H. J., Roberval, Que.  
 Begin & Picard, Lambton, Que.  
 Belanger, Alexis, St. Alexandre, Que.  
 Belanger, I., Liniere, Que.  
 Belanger, L., St. Aubert, Que.  
 Belanger, Mrs. P., Tessierville, Que.  
 Belanger, Pierre, Riviere Blanchet,  
 Belisle, N., & Cie., Wotton, Q. [Q.  
 Bell, A. B., Kimberley, Ont.  
 Bell Bros., Cataract, Ont.  
 Benjamin, S. P., Gaspereaux, N.S.  
 Benneweis, J., Brödhagen, Ont.  
 Benoit, E., Callender, Ont.  
 Bicknell, R. F., Camden East, Ont.  
 Biddison, D., Fort Frances, Ont.  
 Riette & Co., Chesley, Ont.  
 Bigelow, A., & Son, Lower Stewiacke,  
 Birdsall, F., Birdsall, Ont. [N.S.  
 Birge, A., Eramosa, Ont.  
 Bishop, O. M., Bishop's Crossing, Q.  
 Bishoprick Bros., Wyevale, Ont.  
 Blackader & Co., Metaghan, N.S.  
 Black, H., Fergus, Ont.  
 Black, R., Corwhin, Ont.  
 Blais, Philomen, Thurso, Que.  
 Blake & Hammond, S. Stukely, Que.  
 Blanchette, A., Mount Carmel, Que.

## GENERAL LIST OF CANADIAN MANUFACTURERS.

- Blanchet, V., Ruisseau a l'Eau  
[Chauve, Que.]
- Blind River Lumber Co., Blind River, Ont.
- Bloom, Jacob, Glen Ray, Ont. [Ont.]
- Bloom, J., Oil Springs, Ont.
- Boegel, John, St. Clements, Ont.
- Boileau, J., Clarence Creek, Ont.
- Boilly, O., St. Paul's Bay, Que.
- Boire, A., Granby, Que.
- Boisvert, E., Durham, Que.
- Bogart, Jacob, Ufford, Ont.
- Boland & Blaedon, Killaloe, Ont.
- Boughmer, Jno. H., Aylmer, Ont.
- Bonnell Bros., Hoath Head, Ont.
- Bok, Ed., St. Ann's, Ont.
- Booth, J. R., Wisawasa, Ont.
- Booth, J. R., Ottawa, Ont.
- Boswell, Walter, Trent Bridge, Ont.
- Bottager, F., Mildmay, Ont.
- Bouchard & Lafaivre, Charrington, Q.
- Boucher, A., Tessierville, Que.
- Bousquet, N., & Co., St. Johns, Que.
- Boutin, F. X., & Frere, Lake  
[Megantic, Que.]
- Boutin, Jos., Ste. Julie, Que.
- Bouvette & Dubois, St. Albert, Que.
- Bowen, A., & Sons, Mountain, Ont.
- Bower, E., Lucknow, Ont.
- Bower Bros., Shelburne, N.S.
- Bown, William, Robinson, Que.
- Boyd, A., Bracebridge, Ont.
- Boyd, J. W., Flesherton, Ont.
- Boyd, J. & W., Proton Station, Ont.
- Brace, P. J., Housey's Rapids, Ont.
- Bracken Bros., Boston Mills, Ont.
- Bradley, E., Honeywood, Ont.
- Bradley, Sam., Glen Almond, Que.
- Brackenbridge, John, Westwood, O.
- Brakey, John, Chaudiere Mills, Q.
- Brennan, E. S., Sundbridge, Ont.
- Breton, Francois, St. Neree, Que.
- Breault, D., St. Romain, Que.
- Breault, Pierre, St. Wincelas, Que.
- Briggs, J. T., Marmoran, Ont.
- Brigham, H., Allan Park.
- Brimacombe, Thomas, Haydon, Ont.
- Brisbin, Chas., Vicars, Que.
- Brisbin, Wm., Yelverton, Ont.
- Britton, George A., Bristol, N.B.
- Brodeur, Jos., Cavignac, Que.
- Bronsans & Weston Lumber Co. Ltd.,  
[Ottawa, Ont.]
- Broodwell, A. & A., Kingsville, Ont.
- Brook, E., Red Bay, Ont.
- Brook, W. J., & Bro., Grimsthorpe, O.
- Bouillette, E., Rochelle, Que.
- Brouillet, E., Ste. Anne de Stukley, Q.
- Brown, D. F., Moe's River, Que.
- Brown, J. E., Delta, Ont.
- Brown, James, Acton, Ont.
- Brown, James, Weldford, N.B.
- Brown, Jos., Pertage du Forte, Que.
- Brown, Robt. G., St. Jovite, Que.
- Brown, S., Bracebridge, Ont.
- Brown, Bros., Carmunnock, Ont.
- Brule, Leon, St. Francois du Lac, Q.
- Brunette Saw Mill Co. Ltd., New  
[Westminster, B.C.]
- Brush & McLane, Harrow, Ont.
- Buchanan, Geo. O., Kaslo, B.C.
- Buchanan, Geo. O., Nelson, B.C.
- Buell, Hurdman & Co., Hull, Que.
- Bullis, S. V., Athens, Ont.
- Bullis & Sherman, Athens, Ont.
- Bunstead, Chas. E., Brookholm, Ont.
- Bureau, David, Lambton, Que.
- Burgess, J., Grand Falls, N.B.
- Burgess, T., Bala, Ont.
- Burgess Milling Co. Ltd., Allan's  
[Mills, Ont.]
- Burke, Alex., Roebuck, Ont.
- Burnett, F., Birdsall, Ont.
- Burnett, Frank, Gay's River, N.S.
- Burnett Bros., Appin, Ont.
- Burnham, W., Folger, Ont.
- Burn, John, Janetville, Ont.
- Burpee, George F., Avondale, N.B.
- Burrard Inlet Red Cedar Lumber Co.  
[Ltd., Victoria, B.C.]
- Burton, Chas. P., Keremos, B.C.
- Burton, J., Rugby, Ont.
- Butler, H., Waterloo, Que.
- Butter, L., Dereham Centre, Ont.
- Buzzell, G. S., Cherry River, Que.
- Byram, E. A., Blenheim, Ont.
- Byram, P. O., St. Leonards, N.B.
- Byrne Bros., Norton, N.B.
- Cada, J., Pike Creek, Ont.
- Cadwell, F. W., Lombardy, Ont.
- Cairns, Geo., Utica, Ont.
- Caldough, H., Cutler, Ont.
- Caldwell, B., New Dublin, Ont.
- Caldwell, Thos. J., Port Daniel, Que.
- Caldwell, W., Lanark, Ont.
- Call, L. M., West Brome, Que.
- Celverley & Co., Gilmour, Ont.
- Cameron, H., Folger, Ont.
- Cameron, L., & Son, Iroquois, Ont.
- Cameron & Kennedy, Norman, Ont.
- Campbell, A., Eskdale, Ont.
- Campbell, B., Hartington, Ont.
- Campbell, D. M., Glen Rae, Ont.
- Campbell, D., Port Elgin, Ont.
- Campbell, John B., Port Au Pique,  
[N.S.]
- Campbell, John, Dalesville, Que.
- Campbell, J., Colwell, Ont.
- Campbell, S. E., Upper Brighton, N.B.
- Campbell, W. B., Campbellcroft, Ont.
- Campbell Bros., Gesto, Ont.
- Campbell & McNabb, Douglas, Ont.
- Campion, George, Owen Sound, Ont.
- Canada Lumber Co. Ltd., Carleton  
[Place, Ont.]
- Canning, R. G., Camilla, Ont.
- Card, J. J., Plevna, Ont.
- Cardinal Mfg. Co., The, Cardinal, O.
- Carew, John, Lindsay, Ont.
- Cargill, H., & Son, Cargill, Ont.
- Carlner & McMaster, Bros.,  
[Kenmore, Ont.]
- Carlaw, J., & Son, Corbetton, Ont.
- Carlow, James, Melancthon, Ont.
- Carnegie, J., Port Perry, Ont.
- Caron, Francois, St. Donat, Que.
- Carpenter, D. W., N. Augusta, Ont.
- Carrette, Thomas, St. Joseph, Que.
- Carrick Bros., Fawkham, Ont.
- Carrier, M., Mirabel, Que.
- Carrier, W., St. Francois Xavier de  
[Brompton, Que.]
- Carr, F. T., Eugenia, Ont.
- Carr, J. H., & Sons, Canterbury, N.B.
- Carswell & McKay, Calabogie, Ont.
- Cartwright, G., Progresstown, Ont.
- Carvill, J. S., Lakeville, N.B.
- Cass Bros., Martinville, Que.
- Castonguay, D. O., Lambton, Que.
- Cathcart, D. M., Liniere, Que.
- Cavanagh & Co., Calabogie, Ont.
- Chambers, C., Scotland, Ont.
- Chambers, Leonard, Waterford, Ont.
- Champoux, D., & Bro., D'Israeli, Q.
- Chapleau, O., Terrebonne, Que.
- Chapman, J., Fernhill, Ont.
- Chapman & Bracken, Seeley's Bay,  
[Ont.]
- Chappell Bros., Baie Verte, N.B.
- Charette & Cheney, South Indian, O.
- Charland, Jos., Wotton, Que.
- Chew Bros., Midland, Ont.
- Chew, Joseph, Chelmsford, Ont.
- Chicoine, A., St. Theodore, D'Acton,
- Chisholm, W. F., Roslin, Ont. [Que.]
- Chisholm, Wm., Halifax, N.S.
- Christie, R., Chesley, Ont.
- Chouinard, N., St. Damase des  
[Aulnais, Que.]
- Chouinard, N., St. Modeste, Que.
- Church, Mitchell & Fee,  
[Drummondville, Que.]
- Clancy, M., Wilson's Mills, Que.
- Clark, John S., Warwick, Ont.
- Clark, Zenus, Varney, Ont.
- Clark Bros., Zephyr, Ont.
- Clark, Adam, Alvington, Ont.
- Clark, H. W., Riverview, Ont.
- Clark, J., Maxwell, Ont.
- Clark, Simeon, Southampton, N.B.
- Clark, V. G., Lost Channel, Ont.
- Clark, W., Mitchell Square, Ont.
- Clark Bros., St. John, N.B.
- Clark & McIntyre, Jack of Clubs  
[Lake, B.C.]
- Clark, Skilling & Co., Newcastle, N.B.
- Clemens, D. W., Roseville, Ont.
- Cloather, A., Kemptville, Ont.
- Clouthier, Nap., Chateau Richer, Q.
- Cluff, J., Mar, Ont.
- Cockburn, J., Edgar, Ont.
- Cody, N., Stoneham, Que.
- Cole, L., Cloyne, Ont.
- Cole, W. B., Sparta, Ont.
- Collins Inlet Lumber Co., Toronto, O.
- Collison, Gibson, Aberdeen, Ont.
- Columbia River Lumber Co., Beaver.
- Comeau, J., Maniwaki, Que. [B.C.]
- Comtois & Co., Drummondville, Que.
- Cone, C., Heyworth, Que.
- Coney Bros., Butternut Bridge, N.B.
- Conger Lumber Co., Parry Sound, O.
- Conklin, David, Kingsville, Ont.
- Conlin, J. & T., Thorold, Ont.
- Conway, G. O. S., Stonefield, Que.
- Cook, C., Creighton, Ont.
- Cook, C., Muirkirk, Ont.
- Cook, James, Rocklyn, Ont.
- Cook & Bros., Lumber Co. of Ontario,  
[Ltd., Toronto, Ont.]
- Cook & Gortz, Dashwood, Ont.
- Cookshire Mills Co., Cookshire, Que.
- Cooms, J. & L., Morton, Ont.
- Cooper, D. G., Collingwood, Ont.

GENERAL LIST OF CANADIAN MANUFACTURERS.

- Cooper, John, Bloomfield, Ont.  
 Coops, J. & J., Brooklyn, N.S.  
 Copeland, George, Wyebridge, Ont.  
 Copeland & Sons, Midland, Ont.  
 Copeland & Sons, Penetanguishene,  
 Copping, John, Rawdon, Que. [Ont.  
 Copping, William, Joliette, Que.  
 Copp, Adam B., Gt. Shemogue, N.B.  
 Copp, Hazen, Port Elgin, N.B.  
 Corbeil, Michel, Ste. Dorothee, Que.  
 Corbeil, C., & Frere, Mascouche, Que.  
 Corliss, H. E., Corliss, Que.  
 Costello, J., Brudenell, Ont.  
 Cottrill Bros., Gresham, Ont.  
 Coultis, Geo., Thedford, Ont.  
 Coultis Bros., Forest, Ont.  
 Coupal, Joseph, Casselman, Ont.  
 Coupal, J., South Casselman, Ont.  
 Coursol, F., Ste. Hypolite, Que.  
 Cox, G., Meaford, Ont.  
 Craig, James, Cottam, Ont.  
 Craig, J., St. Augustine, Ont.  
 Craig, J. P., Proton, Ont.  
 Craig & Austin, Kinmount, Ont.  
 Craig, Jas & Son, Emsdale, Ont.  
 Craig, T. & J., Inwood, Ont.  
 Cranston, A. F., Caledon East, Ont.  
 Crawford, J., Durham, Ont.  
 Crawford, William, Gartmore, Man.  
 Crawford, W. G., Tilbury Center, O.  
 Crawley, H. W., Sydney, N.S.  
 Creary, P., & Co., Cooksville, Ont.  
 Crete, George, St. Severin, Que.  
 Crosby, Edwin, Carleton, N.S.  
 Cross, R. H., Weedon Station, Que.  
 Cross, W., Maple Grove, Que.  
 Cross & McDonald, Weedon St'n., Q.  
 Crowell, O., Bothwell, Ont.  
 Cummings, David, Dunham, Que.  
 Curran, John, New Mills, N.B.  
 Curran, N. D., Hemmingford, Que.  
 Curran Bros., Amherst, N.S.  
 Currie, William, & Co., Eel River  
 [Crossing, N.B.  
 Curry & Thrasher, Forrester's Falls,  
 [Ont.  
 Curtis, Warren, Three Rivers, Que.  
 Cushing, A., & Co., St. John, N.B.  
 Cusick, Michael, Barnesville, N.B.  
 Cutler & Savage Lumber Co., Cutler,  
 [Ont.  
 Dale, John, Dwight, Ont.  
 Daley, M., Bradshaw, Ont.  
 Dallaire, R., St. Samuel de Gayhurst,  
 [Que.  
 Dansereau, J. H., Vercheres, Que.  
 Daoust & Daoust, Ste. Victoire, Que.  
 Dargavel, R. M., Dornoch, Ont.  
 Davidson, D., Penetanguishene, Ont.  
 Davidson, E. D., & Sons, Ltd.,  
 [Bridgewater, N.S.  
 Davidson, J., Barrie, Ont.  
 Davidson, Hay & Co., Toronto, Ont.  
 Davies & Dean, Richards Landing,  
 Davis, J. T., Aurora, Ont. [Ont.  
 Dawson, J. A. & M., Windham  
 [Centre, Ont.  
 Dawdy, Isaac, Eagle, Ont.  
 Day, H., Harrowsmith, Ont.  
 Dean, A., (Estate of) Campden, Ont.  
 Dean, D., Jordan, Ont.  
 Dean, M. A., Sprucedale, Ont.  
 Dean Bros., Gibson, Ont.  
 Dechene, Jos., St. Aubert, Que.  
 DeCew, T. H., Essex, Ont.  
 De Gear, David, Rymal, Ont.  
 Delorme, Felix, Ste. Anne des  
 [Plaines, Que.  
 Demers, Arthur, St. Flavien, Que.  
 Demick, T. E., Stanstead, Que.  
 Dempster, J., Petawawa, Ont.  
 Dery, Jos., St. Hilaire, Que.  
 Deschenes, A., St. Jean de Dieu, Que.  
 Desiel, Frederic, St. Elie, Que.  
 Deslaurier, Z., Wotton, Que.  
 Deslauriers, F., & Co., Valois, Que.  
 Desrochers, Jos., St. Flavien, Que.  
 Desrochers, L., Methot's Mills, Que.  
 Deutschman, F., Tecswater, Ont.  
 Devitt, J., Forks Road, Ont.  
 Devitt & Smith, Winger, Ont.  
 Dey, Thomas, Moose Creek, Ont.  
 Dickie, Alfred, Lr. Stewiacke, N.S.  
 Dickie, David H., Parrsboro, N.S.  
 Dickson, Thos. C., Glen Eden, Ont.  
 Dickson Co., The, Peterborough, Ont.  
 Dillabough, A., Heckstone, Ont.  
 Dillibaugh, A., Millar's Corners, Ont.  
 Dingwall & McDonnell, Williams-  
 [town, Ont.  
 Dinwoodie, W. A., Mentnor, Ont.  
 Doane, H. & J. R., Barrington, N.S.  
 Dodd, H., Nile, Ont.  
 Dodge, B.H., Kentville, N.S.  
 Doersam, J. T., Kurtzville, Ont.  
 Dolan, John, Shawville, Que.  
 Doliff, E. B., Fitch Bay, Que.  
 Donaldson, J., Bayfield, Ont.  
 Donaldson, W., & Co., Mount Healey,  
 L'Annelley, Peter, Tait, Ont.  
 Doten, J., Green River, Ont. [Ont.  
 Doty, Jno. A., Bradshaw, Ont.  
 Doucet, E., St. Justin, Que.  
 Doucet, Louis, Plessisville, Que.  
 Doucet, M., & Fils, Thetford Mines,  
 Dowding, George, Kerrwood, Ont.  
 Dowling & Fletcher, Alma, N.B.  
 Doyle, James P., Armstrong's Brook,  
 [N.B.  
 Drader, Wm. M., Northwood, Ont.  
 Drummond, J. F., Clayton, Ont.  
 Dryden, W. K., Galt, Ont.  
 Dube, A., St. Pamphile, Que.  
 Duboyce, R. P., West Bolton, Que.  
 Dubuc & Lafond, Wickham West, Q.  
 Dufault, E., Ste. Helene, Que.  
 Duff & Stewart, Bluevale, Ont.  
 Duffus, John R., Thamesville, Ont.  
 Duffey, W. H., Hillsborough, N.B.  
 Dufour, Jos., Little Metis St'n, Que.  
 Dufresne, O., Jr., & Frere, Montreal,  
 [Que.  
 Dumas, Jos., St. Isidore, Que.  
 Dunbar, Wm., Sterling Falls, Ont.  
 Dunbar, James, Sundbridge, Ont.  
 Dundee Mills Co., St. John, N.B.  
 Dunloy, R., Napier, Ont.  
 Dunlop, W., Kintore, Ont.  
 Dunn, R., & Son, Arkona, Ont.  
 Dunn, W., Hammond, Ont.  
 Dunn Bros., St. John, N.B.  
 Durham, W. B., Grimsby, Ont.  
 Dutch, George, New Mills, N.B.  
 Duvall, J. W., Grimsby, Ont.  
 Duval, J. A., Newington, Ont.  
 Dwer, P. & J., Enterprise, Ont.  
 Dyke, C. D., St. Malo, Que.  
 Edwards, Robt., Woodham, Ont.  
 Empey, Jos., The Brook, Ont.  
 Eagan, Peter, Clinton, B.C.  
 Earl Bros., Lachute Mills, Que.  
 Eastman, O., Fulford, Que.  
 Eastman Lumber Co., Eastman, Que.  
 Eaton, H. F., & Son, Milltown, N.B.  
 Eaw, Claire & Bow River Lumber  
 [Co., Calgary, N.W.T.  
 Ebbage, Thos., Acton, Ont.  
 Eby, A., Floradale, Ont.  
 Edwards, W. C., & Co., Ltd., Ottawa,  
 [Ont.  
 Edy, Richard W., Wolfe Lake, Que.  
 Egleston, William, Angus, Ont.  
 Eidt, David, Red Bay, Ont.  
 Eidt, H., Hanover, Ont.  
 Elderkin, A. C. & C. W., Advocat, N.S.  
 Elder, M. H., Herdman, Que.  
 Ellis, J. A., Fenelon Falls, Ont.  
 Ellis, W., Kleinburg, Ont.  
 Ellison, John, Jr., Port Stanley, Ont.  
 Elmwood Lumber Co., Elmwood, O.  
 Emerson, R., Colingwood, Ont.  
 Ernest, Chas., Mahone Bay, N.S.  
 Erratt, E., Merrickville, Ont.  
 Essery, T. E., Monticello, Ont.  
 Ethier, T., Ste. Julieanne, Que.  
 Excelsior Bending Works, Blenheim,  
 [Ont.  
 Fairhall, Wm., Whiteside, Ont.  
 Fetterley, S., Vars, Ont.  
 Fortune, John, Vesta, Ont.  
 Fox, F. J., Wheatley, Ont.  
 Fraser, Alex., Westmeath, Ont.  
 Fairchild, F. A., & Co., Rapid City,  
 Fairfield, J., St. Eugene, Ont. [Man.  
 Fair, John, Bervie, Ont.  
 Fallon, R. & S., Fingal, Ont.  
 Faneuf, J. B., St. Denis, Que.  
 Farish, R., Kintail, Ont.  
 Fecteau, Jos., Fecteau's Mills, Que.  
 Fecteau, S., St. Agnes, Que.  
 Feir, A., Omamee, Ont.  
 Fenerty, James, Mount Uniacke St'n,  
 [N.S.  
 Fenton, W. J., South Gloucester, O.  
 Ferguson, A., Oil Springs, Ont.  
 Ferguson, D., Komoka, Ont.  
 Ferguson, Bros., Eversley, Ont.  
 Fessendean, L. E., Fulford, Que.  
 Field, H. & B., Laurel, Ont.  
 Filgate, R'ch., Glen Lloyd, Que.  
 Finlay, J. S., Owen Sound, Ont.  
 Findly Bros., Midhurst, Ont.  
 Fisher, E. J., Ancaster, Ont.  
 Fisher, A., & Son, Paisley, Ont.  
 Fish, R. Y., Waterloo, Ont.  
 Fiske, Edward, Joliette, Que.  
 Fitchett, D., Dutton, Ont.  
 Fitzgerald, R., Belfast, Ont.  
 Flater, Isaac, Eberts, Ont.  
 Flatlands Shingle Mill, Flatlands,  
 [N.B.  
 Fleet, Thomas W., Nelson, N.B.  
 Flood, N., Quebec, Que.

GENERAL LIST OF CANADIAN MANUFACTURERS.

Force & Dickinson, Staples, Ont.	George, Phillips & Dougherty, Emo [River, Ont.]	Hall, W. H., Hall's Bridge, Ont.
Ford, J., Glen Morris, Ont.	Georgian Bay Lumber Co., [Waubashene, Ont.]	Halliday, J. N., Merlin, Ont.
Forget, Benjamin, Ste. Anne des [Plaine, Que.]	Gerard, P., Fulford, Que.	Hallman, J. C., New Dundee, Ont.
Forrest, William F., Atwood, Ont.	Germain, Nap., St. Alban, Que.	Hamel, A., St. Ephrem De Tring, Q.
Forsyth, D., Hagersville, Ont.	Gettler, John R., Fullarton, Ont.	Hamel, L. P., Victoriaville, Que.
Forsyth, D., Claremont, Ont.	Gibson, John, Head of St. Margaret's [Bay, N.S.]	Hamel & Lemieux, St. Ephrem de [Tring, Que.]
Fortier, A., Ste. Helene de Chester, [Que.]	Giddings, D. A., Knowlton, Que.	Hamilton, William, Athlone, Ont.
Fortier, Jos., Charlesbourg, Que.	Gilbert, E., Bothwell, Ont.	Ham, N., Massawippi, Que.
Fortier, M., Thetford Mines, Que.	Gilbert, Jos., St. Elizear, Que.	Hammond Bros., Gorrie, Ont.
Fortier, T., & Frere, Valency, Que.	Gilholm, R., Galt, Ont.	Hann, J. H., Stevensville, Ont.
Fortin, A., St. Camille, Que.	Gillespie, A., Innerkip, Ont.	Hanson, N., Windermere, B.C.
Fontaine, M., St. Maurice, Que.	Gillies, J. R., & G., Arnprior, Ont.	Hardy & Dubord, Beauport, Que.
Foster, E., Ingersoll, Ont.	Gillis, P., Fort Coulogne, Que.	Harlow, Abner, Milton, N.S.
Foster, J., Carbetton, Ont.	Gillies, Bros., (The Co. Ltd.) [Braeside, Ont.]	Harlow & Kempton, Milton, N.S.
Fournier, A., St. Charles, Que.	Gillingham, E. W., North Fork, [N.W.T.]	Harnden, G., Havelock, Ont.
Fox, Churchill H., Southampton, N.B.	Gilmore, Alex., Esdraelon, N.B.	Harrison, Aug., Petite Meschins, Q.
Francis, A., & Bro., Pippewa, Que.	Gilmour & Hughson, Hull, Que.	Harrison, W. H., Norwood, Ont.
Fraser, D. R., Edmonton, N.W.T.	Gingras, P., & Frere, Pointe Aux [Trembles, Que.]	Harris, George, Elizabethville, Ont.
Fraser, G. A., Fontenoy, Que.	Gladu, V., St. Francois du Lac, Que.	Harris, G., Dungannon, Ont.
Fraser, J., Gore Bay, Ont.	Golden Lumber Co., Ltd., Golden, [B.C.]	Hartman, George, Ayton, Ont.
Fraser, William, Upper Stewiacke, [N.S.]	Goldsmith, H. C., & B. M., [Annapolis, N.S.]	Harvey Bros., Udora, Ont.
Fraser, A., & Co., L'Anse Au Foin, [Que.]	Goodhue Bros., Danfille, Que.	Haskin, C., Phillipsville, Ont.
Fraser, Donald, & Sons, Fredericton, [N.B.]	Gordon, L., Danville, Que.	Hastings Shingle Mfg. Co., Hastings, [B.C.]
Frechette, L. I., Halifax South, Que.	Gordon, Samuel, Waterford, N.B.	Hatch, J. W., Conn, Ont.
Freeman, W. H., Milton, N.S.	Gordon, William, Bridge End, Ont.	Hawes, R. A., Oterville, Ont.
Freeman Bros., Sable River, N.S.	Gosline, Thomas, Andofer, N.B.	Hawker, J., Corebtt, Ont.
Freeman, J. E. & T., Caldonia [Corner, N.S.]	Gosselin, E., St. Laurent d'Orleans, [Que.]	Hawkesbury Lumber Co., Ltd., [Hawkesbury, Ont.]
Frezell, J., Ingersoll, Ont.	Gosselin, P., Ste. Edwidge, Que.	Hawkes, Robert, Waterford, N.B.
Fuller, W., Bolton Centre, Que.	Goudron, P., & Co., Vancouver, B.C.	Hayden, James, Woodstock, N.B.
Fulton, G., Fulton's Mills, Ont.	Gould, Alfred, Great Village, N.S.	Hayer, James, St. Louis de Gon- [zague, Que.]
Furgurson & McCrimmon, Maxville, [Ont.]	Gould, Isabella, Exeter, Ont.	Hay, W. A. & J. H., Millville, N.B.
Galbraith, E., Tara, Ont.	Goulette, Jos., St. Lazare, Que.	Hayne & Fisher, Brigden, Ont.
Gaunt, James, Whitechurch, Ont.	Gow & McLean, Fergus, Ont.	Heise, G., Neustadt, Ont.
Gibson, J. R. & G. G., Wroxeter, O.	Graf, J. M., Chepstow, Ont.	Heise, H., Preston, Ont.
Gould, I. J., Uxbridge, Ont.	Graham, G., Kimberley, Ont.	Helma, Henry, Brownsville, Ont.
Govenlock, A., Winthrop, Ont.	Graham, J., Grand Valley, Ont.	Henderson, James C., Lower Ireland, [Que.]
Graham, John, Vanbrugh, Ont.	Grant, Jno., Aberfeldy, Ont.	Henderson, W., St. George, Ont.
Graydon, John, Streetsville, Ont.	Grant, J., Maynooth, Ont.	Hennigar, David, Noel, N.S.
Gullett, Wm., Wellman's Corners, O.	Gratton, O. M., St. Isidore, Ont.	Henry, Thomas, Waterford, Ont.
Gabel, John, Nithburg, Ont.	Gravel, P., Chateau Richer, Que.	Herriman, W. L., & Son, Little [Current, Ont.]
Gagne, O., (dit Belavance), [St. Romain, Que.]	Gravel, A., Lumber Co., Etchemin, Q.	Herron, J. & J., Herron's Mills, Ont.
Gagnon, A., St. Romain, Que.	Gray, J. D., Garden Hill, Ont.	Hesie, J., Gormley, Ont.
Gagnon, F., Cleveland, Que.	Gray & Alley, Victoria, B.C.	Hickson, Wm. A., Newcastle, N.B.
Gagnon, J. A., Three Rivers, Que.	Green, J. C., Plattsville, Ont.	Higginson, William, Inkerman, Ont.
Gainor, Wm., Allsaw, Ont.	Grey, W. P., Campbelltown, N.B.	Hillis, Thomas, Belfountain, Ont.
Galbraith, D., Sherbrooke, Que.	Grey & Co., River Charlo, N.B.	Hill, E. B., Luton, Ont.
Galbraith, John, River Charlo, N.B.	Griffin, T., Cowal, Ont.	Hill, French & Co., Musquodoboit [Harbour, N.S.]
Galbraith, J., Novar, Ont.	Griggs, C. H., Sutton, Que.	Hilyard Bros., St. John, N.B.
Gale, G., Carlisle (Middlesex), Ont.	Grondin & Racicot, Notre Dame De [La Salette, Que.]	Hocking, John, Tyrone, Ont.
Gardiner, James, Mill Brook, Ont.	Grosbeck, J., & Son, Wanstead, Ont.	Hodge & Walley, Sherbrooke, Que.
Garl, A. J., & Son, Mansonville, Que.	Grove, J. S., Ringwood, Ont.	Hodgins Bros., North Clarendon, Q.
Gariepy, A., Montebello, Que.	Grundy Bros., & Co., Kincardine, O.	Hogg, W., North Bay, Ont.
Garrett, J., Sharbot Lake, Ont.	Gunter & Co., St. John, N.B.	Holbert, J., Burk's Falls, Ont.
Gastonguay, Arthur, Lourdes, Que.	Hadden, Robert, Vasey, Ont.	Holland & Emery Lumber Co., [Wahnapitae, Ont.]
Gates, C., Hemlock, Ont.	Hagar, A., & Co., Plautagenet, Ont.	Holliday, A. W., Lakelet, Ont.
Gates, A. C., & Son, Weymouth B'ge, [N.S.]	Haines, E., Cheltenham, Ont.	Hollister, Jewell & Co., Garden [River, Ont.]
Gaudet, S. R., Memramcook, N.B.	Hale, F. H., Upper Brighton, N.B.	Holmes, S. E., Harwich, Ont.
Gauthier, M., & Fils, St. Paul de [Chester, Que.]	Hall John T., Tara, Ont.	Honsberger, George, Banda, Ont.
Genelle, Jos., Tapping Siding, B.C.	Hall, H. E., Becancour, Que.	Honsberger, Jacob B., & Son, [Fenwick, Ont.]
Genelle, Peter, & Co., Makusp, B.C.	Hall, J., Plainfield, Ont.	Hookes, Albert E., Quebec, Que.
	Hall, Thos. W., River Louison, N.B.	Hope, R., Lang, Ont.



GENERAL LIST OF CANADIAN MANUFACTURERS.

- Hope, John, & Co., Lachute Mills, Q.  
Hopkinson, Jas. C., Ventry, Ont.  
Hores, F. W., & Sons, Hamilton, Ont.  
Hosbach, J., Lamash, Ont.  
Houle & Co., Somerset, Man.  
House, J., Courtland, Ont.  
Howard, R., & Son, Croydon, Ont.  
Howes & Leighton, Harriston, Ont.  
Howry, J. W., & Son, Fenelon Falls, N.B.  
Hudson, J., Stayner, Ont. [Ont.  
Humberstone & Foster, Holyrood, O.  
Humphrey & Trites, Peticodiac, N.B.  
Hunting, Wm., Huntingville, Que.  
Hunt Bros., Bagot, Man.  
Huntsville Lumber Co., (The) [Huntsville, Ont.  
Huppe, F. X., St. Camille, Que.  
Hurtubise, A. L., & Bro., Hurtubise, [Ont.  
Hustler, Wm., Weidmann, Ont.  
Hutchinson, E., Douglstown, N.B.  
Imperial Lumber Co., Ltd., Toronto, [Ont.  
Independent Match Co., Louiseville, [Que.  
Irving, G. N., Baltimore, N.B. [Que.  
Irwin, Robert U., Shelburne, Ont.  
Irish, Jonathan, Wareham, Ont.  
Jackson, David M., Tidnish, N.S.  
Jackson, Isaac B., Cold Brook, N.S.  
Jackson, Rebecca, Langside, Ont.  
Jackson, J., & Son, Hepworth, Ont.  
Jackson, W., & Son, Kendal, Ont.  
Jalbert, D., Lac Bouchette, Que.  
James, W. H., Mahone Bay, N.S.  
Jamieson, Jas., Powers' Court, Que.  
Jarman, J. C., L'Amable, Ont.  
Jaulin, F., Ruisseau a l'Eau Chaude, [Que.  
Jenkins, E. S., Springfield, Ont.  
Jennings, Thomas, Moray, Ont.  
Jewett, E. W., & Co., St. John, N.B.  
Johnson, Anthony, Buctouche, N.B.  
Johnson, A., Mill Creek, N.B.  
Johnson, H., Coe Hill Mines, Ont.  
Johnson, R., Huntsville, Ont.  
Johnson, W. B., Hemmingford, Que.  
Johnson, W. H., Pefferlaw, Ont.  
Johnston, Alex., Spence, Ont.  
Johnston, J. A., Rutherford, Ont.  
Johnston, R., Madoc, Ont.  
Joliette Lumber Co., Joliette, Que.  
Joly, H. G., Sr., Leclereville, Que.  
Jones, Isaac, Arthur, Ont.  
Jones, John, Newcastle, N.B.  
Jones, Bros., Wiarton, Ont.  
Jones, S. & T., Owen Sound, Ont.  
Jordan, J., Dundalk, Ont.  
Judd, L. F., Kingsey Falls, Que.  
Judd, Bros., Lake Megantic, Que.  
Jackson & Son, Trowbridge, Ont.  
Johnson, Hiram, Widder, Ont.  
Johnston, John, Waldermar, Ont.  
Jordan, E., Windermere, Ont.  
Kastner & Co., Sebringville, Ont.  
Kastner & Co., Wiarton, Ont.  
Kaufmann, J., Cassel, Ont.  
Kays, Patrick, Valcartier, Que.  
Kay, James, Rydal Bank, Ont.  
Kearns, Wright & Co., Utopia, Ont.  
Kean, F., Orillia, Ont.  
Keddy & Ernest, Mahone Bay, N.S.  
Keeler, D., Spencerville, Ont.  
Keeso & Kritzer, Listowel, Ont.  
Keewatin Lumebr & Mfg. Co., [Keewatin, Ont.  
Kehoe, Thos., Hammond Plains, N.S.  
Keillor Bros., Spence, Ont.  
Kelly, Thos., Plessisville, Que.  
Kempfield, F. C., East Clifton, Que.  
Kemptville Lumber & Mfg. Co., [Kemptville, N.S.  
Kent, Wm. J., Truro, N.S.  
Kettle, J., Prospect, Ont.  
Kerr J. F., Iona Station, Ont.  
Kimball Bros., Bryanston, Ont.  
Kidd, John, Wiarton, Ont.  
Kilgour, Shives, Campbelltown, N.B.  
King Bros., Quebec, Que.  
King, G. G. & W. C., Chipman, N.B.  
King, J., & A. L., Bear Lake Ont.  
King, Samuel T., & Sons, St. John, [N.B.  
Kinnear, John L., Inverness, Que.  
Kirkpatrick, Thos, Vancouver, B.C.  
Klages, G., Neustadt, Ont.  
Klock, R. H., & Co., Klock Mills, O.  
Knight & Low, Douglas, Ont.  
Knowlton, Enos, Cambridge, N.S.  
Knowlton Bros., Cambridge, N.S.  
Korry, I. C., Maberly, Ont.  
Krause, Albert, Williamsford, Ont.  
Krupp, J., Metcalf, Ont.  
Lachance, F., & Fils, Fraserville, Q.  
Lachapelle, E., Ste. Julienne, Que.  
Lachevretiere, Frere & Co., Ste. Tite, [Que.  
Lacroix, A., Jr., Ste. Marie, Que.  
Lacroix, L., Champlain, Que.  
Lafamme, B., St. Victor de Tring, Q.  
Lafontaine, T., St. Stanislas, Que.  
Laframboise, E., Ste. Scholastique, [Que.  
Laframboise, Belle Riviere, Que.  
Lafrance & Guerin, Chatillon, Que.  
Lainor, W., Freelon, Ont.  
Lajoie, H., St. Justin, Que.  
Lamb, A. S., Meadowvale, Ont.  
Lambert, Henry, Vanbrugh, Ont.  
Lampman, S., Harrington, Ont.  
Lamy, O., St. Stanislas, Que.  
Lane & Lane, Belmore, Ont.  
Langelier, J. C., Maria, Que.  
Langelle, Jacob, Martin's River, N.S.  
Langevin, Felis, St. Joachim de [Shefford, Que.  
Langevin, F., South Roxton, Que.  
Langevin Bros., McMillan's Corners, [Ont.  
Langford, A., Granton, Ont. [Ont.  
Langford, B., Lucan, Ont.  
Langille, J. H. & A., New Anna, N.S.  
Lanigan, Martin, Kingston, N.B.  
Lantz & Co., Milford, N.S.  
Lapanne, V., St. Chrysostome, Que.  
Lapierre, Chas., St. Sebastien de [Beauce, Que.  
Lapierre, L., East Arthabaska, Que.  
Lapointe, E., St. Paul du Buton, Q.  
Lapointe, N., St. Pamphile, Que.  
Lapointe, O., Ste. Rose du Decele, Q.  
Larlee, Amos H., Perth Centre, N.B.  
Larochele, S., Maple Grove, Que.  
Lauzon, Isidore, South Casselman, O.  
Lavallee, Paul, St. Norbert, Que.  
Lavoie, Jos., St. Jean de Dieu, Que.  
Lawrence, H. & H., Haldane Hill, O.  
Lawrence, J., & Son, King Court, O.  
Lawrence, Jacob, & Sons, Watford, [Ont.  
Lawson, W., Park Head, Ont. [Ont.  
Layallee, Lancour & Co., St. Guil- [laume d'Upton, Que.  
Layton, John, Shubenacadie, N.S.  
Leacock, H. J., Brigden, Ont.  
Leatham, N., Orton, Ont.  
Leavitt, D., Martinville, Que.  
Leblanc & Freres, St. Leonard, Que.  
Lecavalier, Israel, St. Laurent, Que. [Joliette, Que.  
Levesque & Danjou, St. Pacome, Q.  
L'Heureux, J. B., Lorette, Que.  
Leclaire & McRae, N. Lancaster, O.  
Ledingham, J., Alma, Ont.  
Leduc, Joseph, Vinoy, Que.  
Lees, William, Fall Brook, Ont.  
Lefancois, F., Chateau Richer, Que.  
Legault, B., Glen Robertson, Ont.  
Legault, E., St. Amour, Ont.  
Legault, M., Ste. Adele, Que.  
Legendre, E. T., Marsboro, Que.  
Leigh, J., & Sons, Victoria, B.C.  
Leishman & Sons, Bracebridge, Ont.  
Lemelin, A., St. Perpetue, Que.  
Lemieux, X., St. Clothilde, Que.  
Lemire, Felix, St. Severe, Que.  
Lemke, C., Plevna, Ont.  
Leonard & Morin, Moose Bay, Que.  
Leroux, D., St. Amour, Ont.  
Lesperance, E., St. Pierre Mont- [magny, Que.  
Letourneau, X., St. Paul Du Buton, [Que.  
L'Heureux, J. B., Lorette, Que.  
L'Heureux, Nap., St. Guillaume [D'Upton, Que.  
Limoges, Jos., Ste. Hippolyte, Que.  
Limoges & Co., Terrebonne, Que.  
Lindsay, Arch., Aylmer, Que.  
Ling, Jno., Warwick, Que.  
Ling, Wm., Warwick, Que.  
Little, C., Pike Creek, Ont.  
Little, Thomas, Beachburg, Ont.  
Lvingston, E., Bielgrove, Ont.  
Lobsinger, J., Hampden, Ont.  
Lockhart, John, Riversdale, Ont.  
Lockwood, J., Enterprise, Ont.  
London & Petrolea Barrel Co., [London, Ont.  
Longford Lumber Co., (The), Long- [ford Mills, Ont.  
Languay, John, Silsburg, Ont.  
Loranger, Shawenegan, Que.  
Lord, Wm., St. Jacques L'Achigan, Q.  
Loree & Prout, Oil Springs, Ont.  
Lorne Bros., Stanwood, Ont.  
Loughhead, J. S., Sarnia, Ont.  
Lovell, H., & Sons, Coaticooke, Que.  
Lowther, Hazen, Gt. Shemogue, N.B.  
Lueck, William, Williamsford, Ont.  
Lyle, James B., Smith's Falls, Ont.  
Lymburner, H., Dyer's Bay, Ont.  
Lynett, N., Shiloh, Ont.  
Lyon, L., Island Brook, Que.  
Lyons, A., Blackwater Junct., Ont.  
McAdam, Samuel, South River, Ont.



GENERAL LIST OF CANADIAN MANUFACTURERS.

- McAfee, Robert, Hanford Brook, N.B.  
 McAllister, A., Mount St. Louis, Ont.  
 McAlpine, B., Marshville, Ont.  
 McArthur, A., & Son, Monckland [Station, Ont.  
 McArthur, J. D., & Co., Birtle, Man.  
 McAuslan, Robt., Wyoming, Ont.  
 McBurney & Laycock, Callender, O.  
 McCaffrey, Chas., Lake Megantic, Q.  
 McCall, Alex., Apsley, Ont.  
 McCall, John A., Lake, Ont.  
 McCallum, J. A., Avon Mills, N.S.  
 McCann, E., & Son, Dorchester St'n., [Ont.  
 McCarroll, R., Lucknow, Ont.  
 McCarthy, John, Ste. Julienne, Que.  
 McClure, Alex., Truro, N.S.  
 McClymont, Wm., & Co., Ottawa, O.  
 McCrab, W., Lotus, Ont.  
 McCracken, J., Staples, Ont.  
 McCrae, John, Marden, Ont.  
 McCrae, A., & Son, Everett, Ont.  
 McCreary, H., Cottam, Ont.  
 McCredie, W., Lyons, Ont.  
 McCulloch & McPayden, Fullarton, [Ont.  
 McDiarmid, J. D., Aylmer, Ont.  
 McDermitt, J. Victoria Harbor, O.  
 McDonald, A., Peterboro', Ont.  
 McDonald, A. F., Cornwall, Ont.  
 McDonald, A. J., Sebright, Ont.  
 McDonald, Alex. W., Beeton, Ont.  
 McDonald, D., Belwood, Ont.  
 McDonald, D. B., South Indian, Ont.  
 McDonald, John, Chatham, N.B.  
 McDonald Bros., McDonald Corner, [N.B.  
 McDonald, L., & Co., Walton, Ont.  
 McDonell, H., Bismark, Ont.  
 McDougall, Jas., Westover, Ont.  
 McDugall, J. P., & Co., Maxville, O.  
 McEvoy, J. F., L'Orignal, Ont.  
 McEwan, S., Bannockburn, Ont.  
 McEwen & Munro, Moose Creek, O.  
 McGarvin, D. R., Chatham, Ont.  
 McGibbon, F., & Son, Penetanguishene, Ont.  
 McGibbon, P. & A., Lachute Mills, Q.  
 McGilles, M., St. Andrews West, O.  
 McGregor, D., Ripley, Ont.  
 McGregor, Jno., Ashdad, Ont.  
 McGugan, A. & J., Hilton, Ont.  
 McGugan, John, Talbotville, Ont.  
 McGuire, W. G., Edy's Mills, Ont.  
 McIntosh, D., Dalkeith, Ont.  
 McIntyre, A., Aberfoyle, Ont.  
 McIntyre, N., Napier, Ont.  
 McIntyre, N. & A., Pinkerton, Ont.  
 McIntyre & Son, Glamis, Ont.  
 McKav, George, Clyde River, N.S.  
 McKay, J., Lovat, Ont.  
 McKay, Jas. A., & Co., Clyde River.  
 McKean, A., Kolapore, Ont. [N.S.  
 McKee, Benjamin, Stoneham, Que.  
 McKee, D., Dutton, Ont.  
 McKee, John, Rose Island, Ont.  
 McKenzie, D., Nairn, Ont.  
 McKenzie, Geo. M., Appin, Ont.  
 McKenzie, J. S., Morrisburg, Ont.  
 McKenzie, T. & J. A., Millfield, Que.  
 McKinley, Jas., Mill Stream, Que.  
 McKinnon & Walsh, Little Current, [Ont.  
 McLachlan, Wm., Magnetawan, Ont.  
 McLachlin Bros., Aruprior, Ont.  
 McLaughlin, D. J., Pallet River, N.B.  
 McLaughlin, Jno., Avonmore, Ont.  
 McLaughlin, S., Sr., Black Point, N.B.  
 McLaughlin Bros., Black Point, N.B.  
 McLean, James, Springbank, Ont.  
 McLean, John, Campbell's Bay, Que.  
 McLean, Malcolm, Belmore, Ont.  
 McLean & Son, Wingham, Ont.  
 McLennan, A., Casselman, Ont.  
 McMackon, D., High Gate, Ont.  
 McMackon Bros., Romney, Ont.  
 McMann, Bros., Moser's River, N.S.  
 McMartin, Duncan, Berwick, Ont.  
 McMicken, J. S., Riverview, Ont.  
 McMillan, John, Jr., Blyth, Ont.  
 McMillan, J. & W., Morley, Ont.  
 McMullen, T. G., Truro, N.S.  
 McMurray, Jas., Red Deer, N.W.T.  
 McMurchy, A. & G., Uplands, Ont.  
 McNair, Nat., River Louison, N.B.  
 McNally, Jas., Vars, Ont.  
 McNeil, J. J., Gravenhurst, Ont.  
 McNeil, Walter, Leith, Ont.  
 McNeill, Aaron, & Son, Aylesford, [N.S.  
 McNichol, D. & D., Watson's [Corners, Ont.  
 McNish & McKenzie, Algonquin, O.  
 McNiven, John, Kippen, Ont.  
 McPhee, D. D., & Co., Alexandria, O.  
 McQuay, T. W. & R. J., Inistioge, O.  
 McQueen, J. S., Pelee Island, Ont.  
 McRae, J. D., Eganville, Ont.  
 McRae, Peter, New Richmond, Que.  
 McRae, R., Powassen, Ont.  
 McRay, J., McCrimmon, Ont.  
 McVicar, E. W., Johnston's Harbor, [Ont.  
 McWilliams, T., Trout Brook, N.B.  
 MacArthur, P., Westbourne, Man.  
 MacLaren, J., & Co., (Estate of) [Buckingham, Que.  
 Mace, J. H. & R., Butternut Ridge,  
 Mackie, W., Drumbo, Ont. [N.B.  
 Mailhot, L., Ste. Sophie de Levrard, [Que.  
 Maitland, Rixon & Co., Owen Sound, [Ont.  
 Magnan, F. X., Pointe Aux Trembles,  
 Magnan, M., Rawdon, Que. [Que.  
 Maher, F., St. Hugues, Que.  
 Major & Blanchet, Patillo, Ont.  
 Mallard, D. J., Oxenden, Ont.  
 Mallory, C., Ridley, Ont.  
 Marchand, A., St. Andre, Que.  
 Marcoux, M., Et. Eugene de [Grantham, Que.  
 Margeson, Arthur, Hantsport, N.S.  
 Marier, A., Ste. Agathe des Monts, Q.  
 Marois, Isaac, St. Joachim de [Shefford, Que.  
 Marvenger, S., & Co., Pointe au [Chene, Que.  
 Marshall, John, Lilolet, B.C.  
 Marsh, Henry, Maple, Ont.  
 Marsh, H., Kincardine, Ont.  
 Marston, R., St. Joachim de Shefford,  
 Marston, R. S., Warden, Que. [Que.  
 Marston, S. C., Warden, Que.  
 Martel, F. X., Lorette, Que.  
 Martin, J., Port Hope, Ont.  
 Martin, Samuel, Butternut Bridge,  
 Martin, S., Kars, Ont. [N.B.  
 Martin, Jas. H., Westport, Ont.  
 Marcheldon, A., Sturgeon Falls, Ont.  
 Mallony, Chas., Troy, Ont.  
 Mason, Jas., Rawdon, Que.  
 Mason, Wm., & Sons, Ottawa, Ont.  
 Masse, H., Chemin Tache, Que.  
 Masse, O., Trois Pistoles, Que.  
 Masse, X., Ste. Agathe, Que.  
 Matheson, G. K., Moncrieff, Ont.  
 Matte, Louis, Pont Rouge, Que.  
 Matte & Matte, Notre Dame des [Ange, Que.  
 Maxwell, A. F., Moore's Mills, N.B.  
 Maybee & Derbyshire, Odessa, Ont.  
 Menard, Jos., St. Denis, Que.  
 Meredith, J. K., South Indian, Ont.  
 Merick, S. S., Carleton Place, Ont.  
 Merizzi, V., Farndon, Que.  
 Merrick, J. J., Newton, Ont.  
 Merrill, Geo. W., Compton, Que.  
 Merrill, Ring & Co., Byng Inlet, Ont.  
 Methot, A., St. Antoine de Tilly, Que.  
 Metivier & Boivin, St. Damien, Que.  
 Michaud, E., St. Fabien, Que.  
 Michell Bros., Lucknow, Ont.  
 Mickle, Dymont & Son, Barrie, Ont.  
 Middleton, E. W., Athens, Ont.  
 Mignault & Frere, St. Charles, Que.  
 Millard, J., Newmarket, Ont.  
 Millar, J., Inverhuron, Ont.  
 Miller, B. B., Warton, Ont.  
 Miller, Charles, St. John, N.B.  
 Miller, Jas. E., Newcastle, N.B.  
 Miller, Jos., Jr., Maitland, N.S.  
 Miller, R. O., Gravenhurst, Ont.  
 Miller, W. H., Campbelltown, N.B.  
 Miller Bros., McLaren's Depot, Ont.  
 Miller, Jas., & Co., Sherbrooke, N.S.  
 Miller & Woodman, St. John, N.B.  
 Mills, G., Mountain Grove, Ont.  
 Milne, James, Nassagiveya, Ont.  
 Milne, John, Agincourt, Ont.  
 Milne, Peter, Angus, Ont.  
 Milne, W., Ethel, Ont.  
 Milne, W. & J., Stayner, Ont.  
 Milne & Hefferman, Trout Creek, O.  
 Minne, A., Kentville, N.S.  
 Misner, R., Crewe, Ont.  
 Misner, R. A. & W., Kingsbridge, O.  
 Mitchell, A., Bowassan, Ont.  
 Mitchell, D., Knapdale, Ont.  
 Mitchell, H. B., Selkirk West, Man.  
 Mitchell Bros., Berkeley, Ont.  
 Moffat, G., Gibraltar, Ont.  
 Moffat, George, & Co., Dalhousie,  
 Mogk, Henry, Bornholm, Ont. [N.B.  
 Mollins & Jajues, Burgessville, Ont.  
 Mendon & Harel, Yamaska, Que.  
 Mongeau, H., St. Bazile Le Grand,  
 Monlaus, Geo., Bervie, Ont. [Que.  
 Moodyville Saw Mill Co., Moodyville, [B.C.  
 Mooney, H. R., Lower Ireland, Que.  
 Mooney, R., Shelburne, Ont.

GENERAL LIST OF CANADIAN MANUFACTURERS.

- Moore, John, St. Edouard, Que.  
 Moore, R. L., Mechanic Settlement,  
 Moore, S., Falkenburg, Ont. [N.B.  
 Moore, W. J., Mooresburg, Ont.  
 Moore & McDowall Co., The, Prince  
 [Albert, N.W.T.  
 Moore & Vandusen, Lion's Head, O.  
 Morden, A. A., Wellington, Ont.  
 Morais, U., Wickham West, Que.  
 Morgan, Anisley, Bear River, N.S.  
 Morgan, D. N., Apple Hill, Ont.  
 Morgan, Sam'l., & Sons, Bear River,  
 [N.S.  
 Morgan & Caldwell, Springbrook, O.  
 Morin, Noel, St. Jean de Matha, Que.  
 Morissette, T., Mawcook, Que.  
 Morran, Richard, Allenford, Ont.  
 Mirrish, William, Benmiller, Ont.  
 Morrison, D., St. Faustin, Que.  
 Morrison, D. R., Daihouse Mills, O.  
 Morrison, John A., Fredericton, N.B.  
 Morrison, J. D., Milan, Que.  
 Morrison Bros., Mira River, N.S.  
 Morrison, James, & Son, Canterbury,  
 Morrison, Duncan, Vankleek Hill, O.  
 Moses, J. W., West Osgoode, Ont.  
 Muir, H., Grand Valley, Ont. [N.B.  
 Munnis Bros., Markdale, Ont.  
 Murchie, J. G., Fredericton, N.B.  
 Murchie, Jas., & Son, Benton, N.B.  
 Murchie, Jas., & Sons, Edmunston,  
 [N.B.  
 Murchie, Jas., & Sons, St. Stephen,  
 [N.B.  
 Murphy, Jas., Middle Musquodoboit,  
 Murphy, Jas. M., Noel, N.S. [N.S.  
 Murphy, John, Kingston (Kings) N.B.  
**MURPHY, J. E., Hepworth Station P.O.—Wholesale Lumberman Hemlock Dimension Stuff and Builders' Supplies a specialty.**  
 Murray, John, Ruscomb Station, Ont.  
 Murray, John, & Co., Ruscomb St'n.,  
 [Ont.  
 Murray, J., & Son, Grenville, Que.  
 Murrick & Campo, Elb Mills, Ont.  
 Muskoka Mill & Lumber Co., Brace-  
 [bridge, Ont.  
 Mustard, A., Brucefield, Ont.  
 Nadeau, Jos., St. Paul de Chester, Q.  
 Nadeau, P., Stanfold, Que.  
 Nadeau & Boisclair, Stanfold, Que.  
 Nantel, J., & Freres, St. Adolphe de  
 [Howard, Que.  
 Naud, D., St. Alban, Que.  
 Naud, Octave, St. Alban, Que.  
 Naud, O., Poire, Que.  
 Naud & Belanger, Ste. Thecle, Que.  
 Naud & Boisseau, Ste. Adele, Que.  
 Neibergall, Geo., & Co., Staples, Ont.  
 Neilson, R. & A., Proton Station, O.  
 Neilson, R. A., Flesherton, Ont.  
 Neilson, W. G., Stanhope, Que.  
 Nelson & Nelson, Damascus, Ont.  
 Nelson Saw Mill Co., Nelson, B.C.  
 Nesbit, E. T., Quebec, Que.  
 Newton, B., Arden, Ont.  
 Nugent, P., St. Martins, N.B.  
 Nuttall, Isaac, South Lake, Ont.  
 Oakville Basket Co., Oakville, Ont.  
 O'Donnell, Jas., Quyon, Que.  
 O'Leara, Patrick, Thurso, Que.  
 Olmstead, R., Walter's Falls, Ont.  
 Olmstead, F. A., & Co., Sutton, Que.  
 O'Neill, Low & Son, Fairfield, N.B.  
 O'Neil & Simpson, Biscotasing, Ont.  
 Ontario Basket Co., Walkerville, O.  
 Ontario Excelsior Mfg. Co., Chatham,  
 [Ont.  
 Ontario Lumber Co., Ltd., (The),  
 Toronto, Ont.  
 Orr, T. & R., Holland Centre, Ont.  
 Orr, John, Tait, Ont.  
 O'Shaughnessy, M., Nicolet, Que.  
 Ottawa Lumber Co., Calumet, Que.  
 Ouellete, Jos., Trois Pistoles, Que.  
 Oval Wood Dish Co., The, Essex  
 [Centre, Ont.  
 Overholt, James, Eastwood, Ont.  
 Owens, E., Invermay, Ont.  
 Owens, J. T., Fitzroy Harbor, Ont.  
 Owens, T., & Sons, Stonefield, Que.  
 Paine, E., Cultus, Ont.  
 Pallister, R., Moe's River, Que.  
 Palmer, H., Elm hedge, Ont.  
 Palmer, J., Sebright, Ont.  
 Paradis, D., St. Sebastien de Beauce,  
 Paradis, T., Levis, Que. [Que.  
 Parent, Jos., St. Zephirin, Que.  
 Parent, O., St. Zephirin, Que.  
 Parizeau, D., Roxton Falls, Que.  
 Parker, W., Parkerville, Ont.  
 Parker & Bishop, Marbleton, Que.  
 Parker & Howe, Dixville, Que.  
 Parry Sound Lumber Co., Parry  
 [Sound, Ont.  
 Parsons, E. E., Sand Point, Ont.  
 Parsons, L. E., Golden Lake, Ont.  
 Parsons & Davis, Rankin, Ont.  
 Patrick, G. A., Delaware, Ont.  
 Patton, John H., Matane, Que.  
 Payette, D., St. Come, Que.  
 Pearson, John, Sebringville, Ont.  
 Pearson, Wm., Lacolle, Que.  
 Pedwell, H., Thornbury, Ont.  
 Peets Thomas, Duart, Ont.  
 Pellerin, F. X., Stanfold, Que.  
 Pelletier, L., Charlesbourg, Que.  
 Pelletier, O., St. Paschal, Que.  
 Pelletier, S., Mount Carmel, Que.  
 Pembroke Lumebr Co., Pembroke, O.  
 Penault, Thos., MacNider, Que.  
 Peneault, V., St. Anges, Que.  
 Penman, William, Hall's Mills, Ont.  
 Pennington, T. J., Otterville, Ont.  
 Pepin, Louis, St. Jerome, Que.  
 Pepin, L., Warwick, Que.  
 Peppard, A. L., Great Village, N.S.  
 Percival, G. A., Murillo, Ont.  
 Perkins, W. A., East Dunham, Que.  
 Perrault, S., Kildare, Que.  
 Perreault, F., St. Alphonse, Que.  
 Persall, J., Oakland, Ont.  
 Pete, John, Lakefield, Que.  
 Peterman, B., & Son, Colingwood, O.  
 Phillibert, M., St. Elie, Que.  
 Phillips, J., Grand Valley, Ont.  
 Phillips, J. R., Coboconk, Ont.  
 Phillips, S., Belfast, Ont.  
 Phinney, H. M., Wilmot, N.S.  
 Phinney, J. L., Wilmot, N.S.  
 Piche, Louis, St. Ephrem D'Upton, Q.  
 Piche, L., St. Celestin, Que.  
 Piche, Nap., & Frere, Ste. Anne de la  
 [Perade, Que.  
 Piche, Xavier, St. Bazilem, Que.  
 Pickard, Thomas, Glammis, Ont.  
 Pickard & Rowan, Owen Sound, Ont.  
 Pilkey, J. J., Russelton, Ont.  
 Pinder, J. K., Temperance Vale, N.B.  
 Pinkerton, Thos., Pinkerton, Ont.  
 Platzer, Geo., Trout Creek, Ont.  
 Playfair, W. A., Playfair, Ont.  
 Playfair, J., & Co., Midland, Ont.  
 Plante, E., St. Pierre d'Orleans, Que.  
 Plummer, I. P., Millington, Que.  
 Poirier, P., St. Celestin, Que.  
 Poiron, Jos., St. Albin, Que.  
 Poisson, A., Gentlyly, Que.  
 Pomerleau, P., Ste. Marguerite, Que.  
 Potter & Co., Tottenham, Ont.  
 Pope, F. M., Robinson, Que.  
 Porter, J. E., Andover, N.B.  
 Potvin, P. & E., St. Gedeon, Que.  
 Poupore, W. H., Waltham, Que.  
 Powley, C., Marchmont, Ont.  
 Prefontaine, J., Mawcook, Que.  
 Prene, Jean, St. Aubert, Que.  
 Prescott, G. D., Harvey, N.B.  
 Prescott, Geo. D., West River, N.B.  
 Prescott, Gillespie & Co., Shulie, N.S.  
 Presley, Robert, Ashton, Ont.  
 Prevost, G., Powers' Court, Que.  
 Price, H. M., & Co., Quebec, Que.  
 Price Bros., & Co., Quebec, Que.  
 Pringle, G. A., Dobbinton, Ont.  
 Prior, J., Leskard, Ont.  
 Pritchard, Hugh, Amberley, Ont.  
 Proctor, W., Pottageville, Ont.  
 Procnunier, J. & R., Richmond, Ont.  
 Proudfoot, J. & A., Fort Coulonge, Q.  
 Prout, W., Castleton, Ont.  
 Prout, W. W., Oil Springs, Ont.  
 Provencher, A., St. Pierre Baptiste,  
 [Que.  
 Purdy, S. L., Castleton, Ont.  
 Purvis, W. C., St. John, N.B.  
 Quance, F., Bognor, Ont.  
 Quance, R., Jr., Elfrida, Ont.  
 Querengesser, C., Moncrieff, Ont.  
 Quesnel, P. A., St. Andre Avelin, Q.  
 Quickfall, Thomas, Floradale, Ont.  
 Quickfall, W. C., Glenallan, Ont.  
 Rabbitt, Thos. E., & Sons, Gibson,  
 [N.B.  
 Rannie, S., Zurich, Ont.  
 Rainey, Samuel, Severn Bridge, Ont.  
 Ramier & Hayes, Shigawake, Que.  
 Rand, S. D., Randboro, Que.  
 Randolph & Baker, St. John, N.B.  
 Rankin, F., Dover Centre, Ont.  
 Ranville, R., St. Theodore D'Acton,  
 [Que.  
 Ratz, D., Phillipsbay West, Ont.  
 Ratz, J. E., Gad's Hill, Ont.  
 Ratz Bros., Khiva, Ont.  
 Raymond, C. W., Mitchell's Bay, Ont.  
 Raymond, Norman J., Metaghan, N.S.  
 Raymond, Melanson & Co.,  
 [Corberrie, N.S.  
 Reburn, Thomas, Whitfield, Ont.  
 Redden, Rufus, Kentville, N.S.

GENERAL LIST OF CANADIAN MANUFACTURERS.

- Reed, W. W., North Hatley, Que.  
 Reed, Thos., & Sons, Dalhousie, N.B.  
 Reeson, C. D., Cedar Grove, Ont.  
 Reeson, S., Cedar Grove, Ont.  
 Rees, H. C., South Woodslee, Ont.  
 Rees & Sozer, South Woodslee, Ont.  
 Reid, A., Balaklava, Ont.  
 Reid, J. D., Cardinal, Ont.  
 Reid, J., Carmansville, Ont.  
 Reid, P., Lemesurier, Que.  
 Reid, Walter, Ayr, Ont.  
 Reid, Wm., Reid's Mills, Ont.  
 Reid, W., Maple Valley, Ont.  
 Reid Bros., Hepworth, Ont.  
 Reed, John, West Huntingdon, Ont.  
 Reilly, I. R., & Co., Otter Tail, B.C.  
 Reimer, Abram, La Broquerie, Man.  
 Reimer, A. W., Steinback, Man.  
 Renouf, J. G., Trois Pistoles, Que.  
 Renouf, Phillipe, Trois Pistoles, Que.  
 Renwick, R., Dromore, Ont.  
 Reynolds, W. G., St. Catharines, O.  
 Rheault & Cossette, Notre Dame des  
 [Anges, Que.  
 Rhindress, J. H., & Co., Wallace, N.S.  
 Ricard, R., St. Etienne des Gres, Qle.  
 Rice, T. G., Baddeck, N.S.  
 Rice, Harmon, Townsend Centre, O.  
 Richardson, J. F., Apto, Ont.  
 Richardson, J. R., Appin, Ont.  
 Richardson, R., Rockwood, Ont.  
 Richardson, T., Cairngorm, Ont.  
 Richardson, G. B. & Co., Elora, Ont.  
 Richards, David, Campbelltown, N.B.  
 Richards, William, Dacre, Ont.  
 Richard & Co., St. Evariste de  
 [Forsyth, Que.  
 Riddell, A., Hopeville, Ont.  
 Riesberry, R., Bright, Ont.  
 Riordan, Jno. J., Poskshaw, N.B.  
 Ritchie, D. J., & Co., Newcastle, N.B.  
 Ritchie, J. & R., Allan's Mills, Ont.  
 Ritchie, Wm., & Co., Three Rivers, Q.  
 Ritchie, W., & Co., Grand Piles, Q.  
 Rimchy, Melville, York, Ont.  
 Roberts, J., Sombra, Ont.  
 Robert, T., Magenta, Que.  
 Roberts, W. & G., Shetland, Ont.  
 Robillard, N., Lavaltrie, Que.  
 Robinson, D., Revelstroke, B.C.  
 Robinson, E. F., Park Hill, Ont.  
 Robinson, W., Poplar, Ont.  
 Robinson, C. & J., Cambridge, N.B.  
 Robinson, John L., Toledo, Ont.  
 Robertson, James, Windham Centre,  
 [Ont.  
 Robitallie, Chas., Mawcook, Que.  
 Roddick, J., Sr., Lyndhurst, Ont.  
 Roddick, J., & Son, Lyndhurst, Ont.  
 Rogerson & Milne, Lefroy, Ont.  
 Rogers, S., Cedarville, Ont.  
 Rompre & Lefebvre, Valcartier, Que.  
 Ross, David, Whitemouth, Man.  
 Ross, W. D., Bennington, Ont.  
 Ross Bros., Buckingham, Que.  
 Ross, James, Underwood, Ont.  
 Rottenham, H., Clavering, Ont.  
 Rouleau, D., Ste. Tite, Que.  
 Rouleau, Pierre, St. Guillaume  
 [D'Upton, Que.  
 Rourke, Jas., St. Martins, N.B.  
 Rouse, C. A., Lynden, Ont.  
 Rousseau, D., Ste. Marie, Que.  
 Rousseau, Frs., Plessisville, Que.  
 Rousseau, Geo., Robertson's Station,  
 [Que.  
 Rousseau, J. A., St. Anne de la  
 [Perade, Que.  
 Rousseau & Vallee, Notre Dame des  
 [Anges, Que.  
 Rounds, Frank, Welland, Ont.  
 Rowan, Ambrose, Rawdon, Que.  
 Rowell, W., Plover Mills, Ont.  
 Rowell, S. P. J., & Co., Foster, Que.  
 Rowlinson, T. P. & Co., Kinmount,  
 Roy, Jos., Cannan, Ont. [Ont.  
 Roy, Joseph, Riviere Blanche, Que.  
 Roy, Marcel, Ste. Flavie, Que.  
 Roy & Robinson, St. Cyrille de Wen-  
 [dover, Que.  
 Ruddy, James, Victoria Corners, O.  
 Ruiter, E., Cowansville, Que.  
 Ruiter, J. M., Sutton Junction, Que.  
 Ruiter, C., & Co., Brome, Que.  
 Runciman, Randolph & Co., Bridge-  
 [town, N.S.  
 Running, S., Frankville, Ont.  
 Russell, McDougall & Co., Black  
 [Brook, N.B.  
 Rutherford, Wm., & Sons, Ste. Cune-  
 [gonde, Que.  
 Sable River Milling Co., Sable River,  
 Saddler, John, Staffa, Ont. [N.S.  
 Sage, W., Stayner, Ont.  
 St. Anthony Lumber Co., Ltd.,  
 [Ottawa, Ont.  
 St. Maurice Lumebr Co., Three  
 [Rivers, Que.  
 St. Pierre, G., & Co., Fraserville, Q.  
 St. Pierre, Geo., & Co., St. Honore,  
 [Que.  
 St. John, James, Jr., Sunderland, O.  
 Salmon, S., & Co., Avonmore, Ont.  
 Salois, Olivier, St. Bonaventure, Que.  
 Saltzbury, C., Bloomsburg, Ont.  
 Saunders, A., Watford, Ont.  
 Sanderson, Jas., Prince Albert,  
 [N.W.T.  
 Sargeant, John, Chatham, N.B.  
 Sargeant Bros., Nelson, N.B.  
 Saucier & Co., Gamache, Que.  
 Saunders, Isaac W., Nictaux, N.S.  
 Saunders, J. B., Athens, Ont.  
 Savage, F. X., St. Augustin, Que.  
 Sawyer, Albert H., Benton, N.B.  
 Sawyer, Wm., Sawyerville, Que.  
 Sayers, P., Nassagwiweya, Ont.  
 Sayward Mill & Timber Co., Ltd.,  
 (The), Victoria, B.C.  
 Scanlan, C., Kimberley, Ont.  
 Schell, Macpherson & Co., Sayabec,  
 [Que.  
 Scholtzenhauer, H., Rostock, Ont.  
 Schooley & Son, Humberstone, Ont.  
 Schwalm, G. B., Mildmay, Ont.  
 Schweitzer, G. B., Mildmay, Ont.  
 Seile, R., Brinsley, Ont.  
 Scott, B. A., Roberval, Que.  
 Scott, D., Hopeville, Ont.  
 Scott, H., Melville, Ont.  
 Scott, J., Poplar, Ont.  
 Scott, J., Iron Dale, Ont.  
 Scott & Goddard, Knowlton, Que.  
 Scott, J. & T., Allan's Mills, Ont.  
 Scriber, J. & J., Terra Nova, Ont.  
 Scripture, J. C., Colborne, Ont.  
 Sculley, Patrick, New Glasgow, Que.  
 Scully, Patrick, Ste. Hippolyte, Que.  
 Seaman & Newman, Wiarton, Ont.  
 Seaman, N. S., Woodford, Ont.  
 Sellers, F., Bell Rock, Ont.  
 Sewell, E. L., Les Ecureuils, Que.  
 Shannon, D. L., Prince Albert,  
 [N.W.T.  
 Shantz, Jos., Winterbourne, Ont.  
 Sharp, J., Burk's Falls, Ont.  
 Shaver, S., Lunenburg, Ont.  
 Shaw, Alfred, East Oro, Ont.  
 Shaw, F. E., Elmvale, Ont.  
 Shaw, J., Lake Doree, Ont.  
 Shaw, E. W., Novar, Ont.  
 Shaw, C. S., & Co., Flatlands, N.B.  
 Shaw & McDougall, Hallville, Ont.  
 Shaw, Isaac, Wheatley, Ont.  
 Sheff, A., Dover South, Ont.  
 Sheppard, Jas., & Son, Sorel, Que.  
 Sherman, Jas. B., Wellington, Que.  
 Sherwood, Israel, Prince of Wales,  
 [N.B.  
 Shier, J. D., Bracebridge, Ont.  
 Shoemaker, D. M., Berlin, Ont.  
 Shook, J. C., Carbetton, Ont.  
 Shulie Lumber Co., Shulie, N.S.  
 Shuswap Milling Co., Ltd.,  
 [Kamloops, B.C.  
 Silverthorn, J., Stayner, Ont.  
 McKim—TEN in  
 Simmie, W. G., Clavering, Ont.  
 Simpson, R., Lemington, Ont.  
 Simpson, R. W., Coatsworth Station,  
 [Ont.  
 Simpson, Robt., Waterdown, Ont.  
 Sinclair, Edward, Newcastle, N.B.  
 Sinclair, J., McIntyre, Ont.  
 Sissons, S. & R., Byron, Ont.  
 Slater, Wm., Whitelake, Ont.  
 Sloan, J., Melancthon, Ont.  
 Smith, A. S., Port Sydney, Ont.  
 Smith, Bowen, Shediac, N.B.  
 Smith, John E., Blissville, N.B.  
 Smith, M. A., Dunneville, Ont.  
 Smith, William, Clayton, Ont.  
 Smith, William, Clifford, Ont.  
 Smith, William, Gad's Hill, Ont.  
 Smith Bros., Stewart, Ont.  
 Smith & Clerin, Vernon, B.C.  
 Smith, Geo., & Son, Campebl's Bay,  
 [Que.  
 Smith & Harlowe, Martintown, Ont.  
 Smith & Henderson, Blenheim, Ont.  
 Smith, James, & Sons, Woodstock,  
 [N.B.  
 Smith & Scratch, Kingsville, Ont.  
 Smyth, James, Chaudiere Junct., O.  
 Suedden, William, Blakeney, Ont.  
 Snider, Jesse, Hagersville, Ont.  
 Snider Lumber Co., Rosseau, Ont.  
 Snider, W., Wilkesport, Ont.  
 Snodgrass, W. J., Okanagan Falls,  
 [B.C.  
 Snowball, J. B., Chatham, N.B.  
 Soucy, Chas., Ste. Onezime, Que.

GENERAL LIST OF CANADIAN MANUFACTURERS.

- Southampton Mfg. Co., Ltd., (The),  
[Southampton, Ont.]
- Speers, J., Momo Mills, Ont.
- Spence, J., Newbridge, Ont.
- Spencer, C. H., Roblin, Ont.
- Spencer, Cornelius, Ursa, Ont.
- Spencer, C. B., Walsingham Centre,  
[Ont.]
- Speran, C., Brechin, Ont.
- Spicer, Omah, Apple River, N.S.
- Spies, A., Campden, Ont.
- Spore, M., Weidmann, Ont.
- Sproule, R., Tottenham, Ont.
- Sproule, Wm., Vynar, Ont.
- Stack, E., Ilderton, Ont.
- Staebler, George, Cassel, Ont.
- Stafford, Robt., Radstock, Que.
- Stalker, G., Flodden, Que.
- Stalker, M., Port Lewis, Que.
- Stanford, J. & H., Chester, N.S.
- Stark, R. A., Owen Sound, Ont.
- Starks, James, Paisley, Ont.
- Starrak, J. H., L'Islet, Que.
- Steeves, Rufus, Berry's Mills, N.B.
- Sterns, William, Russell, Ont.
- Stetson, Cutler & Co., St. John, N.B.
- Stevens, Levi, Wallace, N.S.
- Stewart, John, Elm Bay, Ont.
- Stickle, G. W., Dartford, Ont.
- Sitll, J. H., St. Thomas, Ont.
- Stinson, J., & Son, Proton, Ont.
- Stothard, Adam, Kingston, N.B.
- Street, C. L., & Co., Chilliwack, B.C.
- Strome, A. S., Fordwich, Ont.
- Strong, W., Matawatchan, Ont.
- Stuart, Daniel, Riverside, N.B.
- Stuart & Stothers, Dungannon, Ont.
- Sweetman Bros., Elford, Ont.
- Swift, Courtney & Beecher Co.,  
[Cumberland, Ont.]
- Switzer, L. B., Desmond, Ont.
- Switzer, L. B., Colebrooke, Ont.  
[Ont.]
- Switzer, Ezra, Violet, Ont.
- Sutton Bros., Clandeboye, Ont.
- Tackaberry, Jno., Alliston, Ont.
- Tait, A., Orillia, Ont.
- Talbot, Jute & Co., St. Eulalie, Que
- Tallman, H., Beamsville, Ont.
- Tamlin, H. T., Savage's Mills, Que.
- Tanguay, Chas, Weedon, Que.
- Tanguay, N. P., Weedon, Que.
- Tanguay & Dube, St. Honore de  
[Shenley, Que]
- Tarywell, R. W., Hillsburgh, Ont.
- Taylor, C. W., Cookshire, Que.
- Taylor, John, Magog, Que.
- Taylor, William, Britannia St'n., O.
- Taylor, O. R., Wheatley, Ont.
- Taylor, Thos., Westfield, Ont.
- Taylor, Wm., & Bros., Udora, Ont.
- Tennant, F. N., Toronto, Ont.
- Tett, J. P., & Bro., Bedford Mill.
- Teeter, Wm. H., Teeterville, Ont.
- Tench, Walter, Waterford, Ont.
- Thomas, C. W., Amherstburg, Ont.
- Thomas, John, & Son, Hammond  
[Plains, N.S.]
- Thompson, Alex., Ettrick, Ont.
- Thompson, J., Orkney, Ont.
- Thompson, J. W., Blytheswoid, Ont.
- Thompson, W. R., Teeswater, Ont.
- Thompson & Avery, Sharbot Lake, O.
- Thompson, John, Tuam, Ont.
- Thomson, J., Bayfield, Ont.
- Thomson, G., Wingham, Ont.
- Thorne, J., Battersea, Ont.
- Thorp, D., Egerton, Ont.
- Thouin, Francois, Ste. Julienne, Que.
- Thouin, R., Ste. Julienne, Que.
- Thurlow, Thomas, Hillsdale, Ont.
- Thurston, James, Cannington, Ont.
- Tims, George, Rutherford, Ont.
- Titus, O. M., West Potton, Que.
- Todd, E., Brantford, Ont.
- Todd, Thomas, St. Helen's, Ont.
- Toffey, H. S., Fallbrook, Ont.
- Toffey, H. S., Portland, Ont.
- Toner & Gregory, Collingwood, Ont.
- Toolery, A. S., Courtrice, Ont.
- Tolton, W. P., Waldemar, Ont.
- Toronto Hcop & Veneer Co., Ltd.,  
[Toronto, Ont.]
- Tourville Lumber Co., Montreal, Q.
- Towner, George, Toronto, Ont.
- Towner, Geo., Trout Creek, Ont.
- Train, T. G. S., Burk's Falls, Ont.
- Trassler Bros., Trout Creek, Ont.
- Tremblay, J., Lyster, Que.
- Tremblay, O., St. Francois, Que.
- Tremblay, Sam., Chateau Richer, Q.
- Tanguay, Chas., Trahan's Mills, Que.
- Trenouth Bros., Trout Creek, Ont.
- Tretheway, Jas., & A., Chilliwack,
- Trott, W. T., Oil City, Ont.
- Truar, P. R., & Co., Holland Centre,  
[Ont.]
- Truax, R., & Co., Walkerton, Ont.
- Trumble, N. W., Patillo, Ont.
- Tupper, Freeman & Sons, Milton,  
[N.S.]
- Tuer, Jos., Thompsonville, Ont.
- Umpherston, W., Poland, Ont.
- Umphrey, M., Udora, Ont.
- Upper, D. & B., Listowel, Ont.
- Urquhart, D., Hensall, Ont.
- Urquhart Bros., Comox, B.C.
- Utterson Lumber Co., (The) Toronto,  
[Ont.]
- Utterson Lumber Co., Utterson, Ont.
- Vadnais, N., St. Cuthbert, Que.
- Vaillancourt, Francois, St. Fabien, Q.
- Vallee, Joseph, Warwick, Que.
- Van Blarcom, H., & Bro., Brighton,  
[N.S.]
- Vandal, T., St. Severin, Que.
- Van, George K., Spring Hill, Que.
- Van Camp, John S., Van Camp  
[Mills, Ont.]
- Van Nostrand, J., Mandorf, Ont.
- Vangesen, A. E., Ingoldsby, Ont.
- Vansickle, W. D., Barri, Ont.
- Vassal, H., Drummondville, Que.
- Veillette, H. G., St. Narcisse, Que.
- Veinot, E., & Co., Bridgewater, N.S.
- Vermillion Lumber Co., Three Rivers,  
[Que.]
- Vernon, W. H., Invermay, Ont.
- Veuilleux & Veuilleux, Mt. Carmel,  
[Que.]
- Vezia & Fils, St. Gabriel de  
[Brandon, Que.]
- Vibert, P., Cape Cove, Que.
- Victoria Harbor Lumber Co., Ltd.,  
[Toronto, Ont.]
- Victoria Lumber Mfg. Co., Ltd.,  
[Victoria, B.C.]
- Victoria Harbor Lumber Co.,  
[Victoria Harbor, Ont.]
- Villeneuve, Pepin & Co., St. Jerome,  
[Que.]
- Vivian, Burrill, Mitchell Station, Q.
- Vogt, Geo., Wiarton, Ont.
- Vollens, Thos., Windsor, Ont.
- Waldie, W., Meldrume Bay, Ont.
- Walker, Edward, Bass River, N.B.
- Walker, Jas., Calgary, N.W.T.
- Walker, Harper, Walker's Point, O.
- Wallace, R., Londesborough, Ont.
- Wallis, J. S., Port Carling, Ont.
- Walsh, J., Little Current, Ont.
- Walsh, R. N., Ormstown, Que.
- Walsh, Rich., Hadlow Cove, Que.
- Walwin, W. S., Alton, Ont.
- Ward, J. K., Montreal, Que.
- Warne, Wm., Eastman, Que.
- Warner, George, Coulson, Ont.
- Warner, R. J., & Co., St. John, N.B.
- Warrell & Howard, Bowassan, Ont.
- Warren, W. B., Landowne, Ont.
- Warwick, William, Shedden, Ont.
- Washington, Andrew, Victoria Road,  
[Ont.]
- Wasson, John, Warsaw, Ont.
- Wettlauffer Bros., Tavistock, Ont.
- Watkins, Bramwell, Clarendon, Ont.
- Watkins, J., Watkin's Mills, Que.
- Watson, James, Colville, Ont.
- Weatherhead, A. McNab, Fermoy, O.
- Weaver, A. B., Lebanon, Ont.
- Weaver & Lewis, Hope Bay, Ont.
- Webber, F. & J., Ingram's River, N.S.
- Webster, A. A., Cambridge, N.S.
- Webster, George, Cold Brook, N.S.
- Wedge Bros., South Bolton, Que.
- Weidman, Paul, Weidmann, Ont.
- Weiler, J., & Son, Formosa, Ont.
- Weir, H., Oxford Mills, Ont.
- Weismiller, H., Jr., Germania, Ont.
- Weldon, S., Lawrence Station, Ont.
- Wells, A. L., Hecla, Man.
- Wells, W. C., Palliser, B.C.
- Wells, W., Princeton, Ont.
- Werden, J. A., Cherry Valley, Ont.
- Westover, L. A., Brome, Que.
- West, Nathan S., Cold Brook, N.S.
- West, J. W., & Co., Sussex, N.B.
- Whaley Lumber Co., Huttsville, Ont.
- Wharton, N., Johnstown, Ont.
- White, A. & P., Pembroke, Ont.
- White, T., Harwood, Ont.
- White, Geo., Weidmann, Ont.
- Whvnot & Harnish, Hubbard's Cove,  
[N.S.]
- Widdifield, W. P., Siloam, Ont.
- Widerick, M., Nanticoke, Ont.
- Wilev, Jos., Woodhouse, Ont.
- Williamson & Cromney, Kingsbury,
- Williams, E., Rush Point, Ont. [Que.]
- Williams, Geo. H., Thorold, Ont.

GENERAL LIST OF CANADIAN MANUFACTURERS.

Williams, James, Arden, Ont.  
 Willard, F. A., Eastman, Que.  
 Willard, F. F., East Angus, Que.  
 Willard, S., Dudswell, Que.  
 Willard, J. C. & Sons, Colton Centre,  
 Willert, W., Dashwood, Ont. [Que.  
 Williscroft, Walter, Port Simpson,  
 [B.C.  
 Wilson, Hugh, Coboconk, Ont.  
 Wilson, James W., Whycomagh,  
 [N.S.  
 Wilson, S. B., & Son, Louise, Ont.  
 Wilson, S. I., & Co., Toronto, Ont.  
 Wing, A., Lynden, Ont.  
 Wingrone, D. M., Gravenhurst, Ont.  
 Winter Bros., Ormstown, Que.  
 Winters, Henry, Ormstown, Que.  
 Wiseman, W. J., Havelock, Ont.  
 Wissler, E., Salem, Ont.  
 Witthun, C. H., & Co., Hepworth, O.  
 Woelfley, J., Pike Bay, Ont.  
 Wood, A., Smith's Falls, Ont.  
 Wood, R. D., Westmoreland Pt., N.B.  
 Wood, Robert, Snow Road, Ont.  
 Wood, R., McLaren's Depot, Ont.  
 Wood, W. S., Nixon, Ont.  
 Wood, Thomas, & Bro., Lime Lake,  
 Woods & Bro., Roblin, Ont. [Ont.  
 Woodley, R., Tyrone, Ont.  
 Woolsey, Geo., Ventry, Ont.  
 Woodstock, S., Mount Albert, Ont.  
 Wright & Son, Newboro', Ont.  
 Wright & Spicer, Newboro', Ont.  
 Wymer, W., Bealton, Ont.  
 Yates, J. L., Hatchley, Ont.  
 Yates, Thomas, Baldwin, Ont.  
 Young, Wm., Wiarton, Ont.  
 Young Bros., Parrsboro', N.S.  
 Young, Leslie & Co., Owen Sound, O.  
 Young, C. Young's Point, Ont.

**MANUFACTURERS.—Paper and Pulp.**

[See also Blank Books in classified list.]

Barber, Wm., & Bros., Georgetown,  
 [Ont.  
 Bissette, Sauve & Co., St. Bazile, Q.  
 British Columbia Paper & Wood  
 Pulp Mfg. Co., Ltd., Victoria, B.C.  
 Buntin, Alex., (Est. of) Valleyfield, Q.  
 Canada Paper Co., (The) Montreal, Q.  
 Canada Wall Paper Factory,  
 [Montreal, Que.  
 Davy, James, Thorold, Ont.  
 Dominion Paper Co., Montreal, Que.  
 Dupont, Louis, Pont Rouge, Que.  
 Dupont, Louis, St. Jean de Neuville,  
 [Que.  
 Eddy, E. B., Mfg. Co., Hull, Que.  
 Fisher, John & Son, Dundas, Ont.  
 Ford, J., & Co., St. Bazile, Que.  
 Jackson, Thos. L., St. Raymond, Que.  
 Laurentide Pulp Co., Ltd., Grand  
 [Mere, Que.  
 Lazier, S. A., Belleville, Ont.  
 Lincoln Paper Mills Co., (The)  
 [Merritton, Ont.  
 Maritime Sulphite Fibre Co., Ltd.,  
 [Chatham, N.B.

McArthur, Colin, & Co., Montreal, Q.  
 McHart, H., Sheet Harbor, N.S.  
 Miller Bros., & Co., Glen Miller, Ont.  
 Milton Pulp Co., Ltd., Milton, N.S.  
 Montreal Paper Co., Portneuf, Que.  
 Morgan Falls Pulp Mill Co., New  
 [Germany, N.S.  
 Napanee Paper Co., Napanee, Ont.  
 Northumberland Paper & Egg Case  
 [Co., Campbellford, Ont.  
 Nova Scotia Wood Pulp Paper Co.,  
 [Mill Village, N.S.  
 Reid, Craig & Co., Lorette, Que.  
 Ritchie & Ramsay, New Toronto, O.  
 Riordan Paper Mills, Merritton, Ont.  
 Rolland, J. B., & Fils, Montreal, Que.  
 Royal Paper Mills Co., (The)  
 [Montreal, Que.  
 Sissiboo Falls Pulp Co., Ltd.,  
 [Weymouth Bridge, N.S.  
 St. Ursule Pulp Mill, St. Ursule, Que.  
 Staunton, M., & Co., Toronto, Ont.  
 Stutt, James, & Sons, W. Flamboro,  
 [Ont.  
 Taylor Bros., Toronto, Ont.  
 Thomson Paper Co., Newburg, Ont.  
 Toronto Paper Mfg. Co., Cornwall, O.  
 Union Card & Paper Co., Montreal,  
 [Que.  
 Watson, Foster & Co., Montreal, Q.  
 Wilson, J. C., & Co., Lachute Mills,  
 [Que.

**MANUFACTURERS.—Stove and Implement Castings.**

Albion Iron Works Co., Ltd.,  
 [Victoria, B.C.  
 American Plow Works, Ayr, Ont.  
 Bedard, L. G., St. Hyacinthe, Que.  
 Beer & Calder, Toronto, Ont.  
 Bernier & Bernier, Lotbiniere, Que.  
 Bernier, T., & Cie, Roberval, Que.  
 Blaikie, F., Sarnia, Ont.  
 Blais, T., Louisville, Que.  
 Bodoin & McIntosh, Cowansville, Q.  
 Bowes, Jamieson & Co., Hamilton, O.  
 Brissette, Jos., Stanfold, Que.  
 Brood, W. H., Mount Pleasant, Ont.  
 Brouillet, A., St. Hilaire, Que.  
 Brown, R., New Glasgow, N.S.  
 Buck, Wm., Brantford, Ont.  
 Butterfield, J. L., Barrie, Ont.  
 Canada Pipe Foundry Co., Hamilton,  
 [Ont.  
 Chamberland, H. C., St. David, Que.  
 Charlesbois, C., & Co., Lachute, Que.  
 Clark, J. E., Duton, Ont.  
 Clement, L. P., Louiseville, Que.  
 Cockshutt Plow Co., Ltd., Brantford,  
 Dain, A., Morrisburg, Ont. [Ont.  
 Day, M. L., Delta, Ont.  
 Desjardines, L. N., Papineauville, Q.  
 Detrick, J., Perth, Ont.  
 Dick, Alex., Alton, Ont.  
 Dobeson, T., & N. W., Nanaimo, B.C.  
 Donevin, W., Lucan, Ont.  
 Douglas & Co., Dartmouth, N.S.  
 Drummond McCall Pipe Foundry Co.,  
 Montreal, Que.

Dussault, H., St. Hyacinthe, Que.  
 Enterprise Foundry Co., Sackville,  
 [N.B.  
 Findlay Bros., Carleton Place, Ont.  
 Findley, John, Montreal, Que.  
 Findlay, John, Ste. Cunegonde, Que.  
 Fortin, Geo., Gaspé Basin, Que.  
 Fortin & Nadeau, Weedon Station, Q.  
 Froidevaux, Francois F., Montreal, Q.  
 Frost, W. H., Smith's Falls, Ont.  
 Gadoury, O. L., Ste. Placide, Que.  
 Guilbault, L., Ste. Elizabeth, Que.  
 Guild, Wm. H., Shubenacadie, N.S.  
 Gulloway, J., Creemore, Ont.  
 Hughes, R., Innisville, Ont.  
 Innes, W., Durham, Ont.  
 Johnson, T., Kemptville, Ont.  
 Kerr & Combs, Hamilton, Ont.  
 Kinch, A. E., Peterboro', Ont.  
 Kyle, Patrick, Merrickville, Ont.  
 Lalonde, J. B., Montreal, Que.  
 Lamonthé & Coderre, St. Ours, Que.  
 Lamping, V., Kemptville, Ont.  
 Larose & Prive, Vercheres, Que.  
 Laviolette, A. A., & Co., St. Jerome,  
 [Que.  
 Leblance, F., Ste. Genevieve de  
 [Batiscan, Que.  
 Lillie, T., Perth, Ont.  
 Linton, G. H., Orono, Ont.  
 Mair, G. L., & Bro., Napanee, Ont.  
 Marchand, G., St. Paul l'Hermite, Q.  
 McGill & Son, Chatsworth, Ont.  
 McKee, I., Little Britain, Ont.  
 McNish, G. P., Lyn, Ont.  
 McSherry, John, Iona, Ont.  
 Moore, D., & Co., Hamilton, Ont.  
 Morgan, William, Richmond Hill, O.  
 Normandeau, S., Ste. Genevieve, Que.  
 O'Keef, M., Chesterville, Ont.  
 Ontario Malleable Iron Co., Ltd.,  
 [Oshawa, Ont.  
 O'Rourke, P., Chatham, Ont.  
 Pattenaude, M., Stockwell, Que.  
 Patenaude, N. F., Sorel, Que.  
 Paulhus, T., St. Guillaume D'Upton,  
 [Que.  
 Pease, J. F., Furnace Co., Toronto, O.  
 Persval, Rogers & Sons, Merrickville,  
 [Ont.  
 Plant, W. P., Norwood, Ont.  
 Plummer Bros., Bolton, Ont.  
 Reid, R., St. Mary's, Ont.  
 Reid & Brown, Toronto, Ont.  
 Rheume & Belanger, Montreal, Que.  
 Ritz, D., New Hamburg, Ont.  
 Robertson Bros., Maxville, Ont.  
 Robertson & Son, Guelph, Ont.  
 Ross, Jno. F., Vancouver, B.C.  
 Runchman, J. B., Goderich, Ont.  
 Savigny, J. A., Nicolet, Que.  
 Savoie, A., Ste. Marie, Que.  
 Sellers, Charles, Toronto, Ont.  
 Sewrey, H., Barrie, Ont.  
 Shaw, Thomas, Victoria, B.C.  
 Sicotte, T., Montreal, Que.  
 Silk, William, Shelburne, Ont.  
 Simard & Simard, Chicoutimi, Que.  
 Skimmin, J., Hamilton, Ont.  
 Smith, E., & Son, Pembroke, Ont.  
 Smith, J. A., Palermo, Ont.

## GENERAL LIST OF CANADIAN MANUFACTURERS.

Smith, William, & Son, Beaverton, O.  
 St. Lawrence Foundry Co., Toronto.  
 Stewart, James, Mfg. Co., Ltd.,  
     [Woodstock, Ont.  
 Tanney, L. N., Iroquois, Ont.  
 Tasse, J. B., Ste. Scholastique, Que.  
 Taylor, John, Vancouver, B.C.  
 Terreau & Racine, Quebec, Que.  
 Thompson, John A., Halifax, N.S.  
 Trottier, Jos., St. Casimir, Que.  
 Veitch, N., Nottawa, Ont.  
 Verity Plow Co., Brantford, Ont.  
 Vezina, Buteau & Proulx, Victoria-  
     ville, Que.  
 Viau, Moses, L'Epiphanie, Que.  
 Walkerville Malleable Iron Co.,  
     [Walkerville, Ont.  
 Ward, R. W., Claremont, Ont.  
 Waterson & Proulx, Fraserville, Que.  
 White, J., Madoc, Ont.  
 Wimmer, J., Delhi, Ont.

### MANUFACTURERS. — Wood- working, Using Steam Power, Wood-working tools and Machinery.

Afflick, A., Lanark, Ont.  
 Aitchison & Co., Hamilton, Ont.  
 Alexandria Mfg. Co., Ltd.,  
     [Alexandria, Ont.  
 Alford & Lear, Belleville, Ont.  
 Anderson & Black, Sunderland, Ont.  
 Anderson Furniture Co., (The)  
     [Woodstock, Ont.  
 Anderson, C., Little Current, Ont.  
 Anderson & Reardon, Toronto, Ont.  
 Anderson Co., Woodstock, Ont.  
 Anthes Mfg. Co., Ltd., (The) Berlin,  
     [Ont.  
 Aquin & Itzweir, Ste. Cunegonde, Q.  
 Armstrong, R. H., Fairville, N.B.  
 Armstrong, T., Pefferlaw, Ont.  
 Atcheson, J., Cornwall, Ont.  
 Attridge, A., & Son, Schomberge, O.  
 Augustine & Son, Port Colborne, O.  
 Baechler, F., Shakespeare, Ont.  
 Baily & Lambert, Toronto, Ont.  
 Baird Bros., Plattsville, Ont.  
 Balcomb, Herman, Vienna, Ont.  
 Ball, George, Barrie, Ont.  
 Ball, Wm., Papineauville, Que.  
 Ball Bros., Granby, Que.  
 Bamford Bros., Listowel, Ont.  
 Barchard & Co., Toronto, Ont.  
 Baril, Wilbrod, Montreal, Que.  
 Barnett, Wm. E., Almonte, Ont.  
 Barry, A., Merrickville, Ont.  
 Bauslaugh, E. W., Kingsville, Ont.  
 Beatty, W., Harriston, Ont.  
 Beatty, W., Pembroke, Ont.  
 Beauchemin Bros., Lawrenceville, Q.  
 Beaudette & Leout, Stanfold, Que.  
 Beaupre, N., & Co., Montreal, Que.  
 Beck, Adam, London, Ont.  
 Beck, Wm., & Co., Montreal, Que.  
 Beckett, Robt., Smith's Falls, Ont.  
 Beckham, J. F., Montreal, Que.  
 Berk, S. A., South Cayuga, Ont.  
 Beechcroft & Sloan, Flesherton, Ont.

Beemer, J., St. George, Ont.  
 Beers, William, Toronto, Ont.  
 Bell, George, Bridgenorth, Ont.  
 Bell, Thomas, Wingham, Ont.  
 Bell Piano & Organ Co., Ltd., (The)  
     [Guelph, Ont.  
 Bennett Furnishing Co., London, O.  
 Benor, J., Campbellford, Ont.  
 Bergeron, Louis, Montreal, Que.  
 Berlin Piano & Organ Co., Ltd.,  
     [Berlin, Ont.  
 Berry, W. J., & Bro., Providence Bay,  
     [Ont.  
 Bettes, A. B., Bracebridge, Ont.  
 Bettchen, J. B., Palmerston, Ont.  
 Bick, F., & Son, Cannington, Ont.  
 Bigford, J., Merrickville, Ont.  
 Birkett, J. H., Kingston, Ont.  
 Bissell Carpet Sweeper Co., Toronto,  
 Black, Andrew, Toronto, Ont. [Ont.  
 Blair, Benj., Shelburne, Ont.  
 Blatchford, G., Elora, Ont.  
 Blonde Bros., & Co., Chatham, Ont.  
 Boake Mfg. Co., Bracondale, Ont.  
 Boehner, Geo. W., & Sons, Bridge-  
     water, N.S.  
 Boehner, G. W., & Son, W. Lahave,  
     [N.S.  
 Borland, George, Coldwater, Ont.  
 Bornais, J., St. Raymond, Que.  
 Bottemley, Thomas, Halifax, N.S.  
 Bourassa, Z., Yamachiche, Que.  
 Boutelle, C., Danville, Que.  
 Bowman, Joseph, Dundas, Ont.  
 Bradshaw, Geo., & Co., Montreal, Q.  
 Brantford Furniture Co., Brantford,  
     [Ont.  
 Breault, R., St. Guillaume D'Upton,  
     [Que.  
 Brennen & Sons Mfg. Co., Ltd.,  
     (The M.) Hamilton, Ont.  
 Briggs, J., & Son, Brockville, Ont.  
 Briston, A., Mountain, Ont.  
 Broadfoot, J. H., Seafort, Ont.  
 Brockville Wringer Co., Brockville,  
     [Ont.  
 Brodeur, E., St. Hyacinthe, Que.  
 Brosseau & Lavigne, Montreal, Que.  
 Brouillet & Aumond, Montreal, Que.  
 Brown, James, Waverley, Ont.  
 Bryan Mfg. Co., (The), Collingwood,  
     [Ont.  
 Buchanan & Ryhmas, Goderich, Ont.  
 Buckingham Planing Mills Co.,  
     [Buckingham, Que.  
 Bundscho, J., Milverton, Ont.  
 Burrows, G., London, Ont.  
 Burr, Bros., Guelph, Ont.  
 Bushlen, S., Port Elgin, Ont.  
 Button & Fessant, Wingham, Ont.  
 Button & Trevett, Teeswater, Ont.  
 Caldwell, R., Columbia, Ont.  
 Campbell, A., Callender, Ont.  
 Campbell, Colin, Beaverton, Ont.  
 Campbell, G. D., Weymouth Bridge,  
     [N.S.  
 Campbell, Manson, Chatham, Ont.  
 Camp Bros., Smithville, Ont.  
 Canada Match Co., St. Anne de La  
     Perade, Que  
 Canada Wheel Works, Merritton, O.

Cane, Wm., & Sons Mfg. Co., Ltd.,  
     [Newmarket, Ont.  
 Canadian Office & School Furniture  
     Co., Ltd., Preston, Ont.  
 Capital Planing Mill Co., Ltd.,  
     [Ottawa, Ont.  
 Card, T., Grafton, Ont.  
 Carlyle, John, Toronto, Ont.  
 Caron & Bergeron, Nicolet, Que.  
 Casavant, Bros., St. Hyacinthe, Que.  
 Carson, W. T., & Son, Oakville, Ont.  
 Carroll, R., Clarksburg, Ont.  
 Carter, W., East Farnham, Que.  
 Cassady, Geo., & Co., Ltd.,  
     [Vancouver, B.C.  
 Cavanagh, John, St. John, N.B.  
 Chalifoux, O., Quebec, Que.  
 Chant, C. H., Unionville, Ont.  
 Chappell, Bros., Tidnish Bridge, N.B.  
 Charbonneau, Israel, Montreal, Que.  
 Charland & Co., Lauxon, Que.  
 Chase, O. D., & Son, Sutton, Que.  
 Cheffey, Robert S., Beeton, Ont.  
 Christie Bros., & Co., Amherst, N.S.  
 Christie & Smith, Truro, N.S.  
 Christie Wood Working Co., St. John,  
 Clark, Zenus, Varney, Ont.  
 Clement & Co., Victoria, B.C. [N.B.  
 Clerke, James, & Son, St. John, N.B.  
 Cleveland, Thos., Lorne, Que.  
 Cliff & Forester, Lucknow, Ont.  
 Cluff, H. R., Ottawa, Ont.  
 Cluff & Bennett, Seaforth, Ont.  
 Cobban Mfg. Co., Ltd., Toronto, Ont.  
 Cockroft Bros., Elora, Ont.  
 Cole, R., St. Thomas, Ont.  
 Coleman Planing Mill Co.,  
     [Burlington, Ont.  
 Collar, G. W., Blenheim, Ont.  
 Cook & Vernal, Brome, Que.  
 Cooper, J. C., Hamilton, Ont.  
 Cooper, S. S., Clinton, Ont.  
 Connor, J. H., Ottawa, Ont.  
 Corbeil & Leveille, Montreal, Que.  
 Corey & Campbell, Bedford, Que.  
 Cosens, Chas., Trowbridge, Ont.  
 Cosgrove, Wm., Berlin, Ont.  
 Coslett, Geo., Bedford, Que.  
 Cote, H. Jr., Papineauville, Que.  
 Cote, Jos., & Cie., Pierreville, Que.  
 Cousins, Henry, Alma, Ont.  
 Cowan, M., St. John, Que.  
 Cowan, O. D., Gananoque, Ont.  
 Coxhead & Co., Toronto, Ont.  
 Craig & Barnum, Ingersoll, Ont.  
 Craig & Co., St. Jerome, Que.  
 Crawford, G., Oro Station, Ont.  
 Crossen Car Mfg. Co., Ltd., Cobourg,  
     [Ont.  
 Cross, A. J., Richmond, Que.  
 Crowley, T., & Co., Toronto, Ont.  
 Cumberland Mfg. Co., (The), Oxford,  
 Cumming, A. E., Lyn, Ont. [N.S.  
 Cummings, A. H., & Son, Coaticook,  
     [Que.  
 Cunningham & Robertson, Montreal,  
 Currie, A. K., Lower, Stewiacke,  
     [N.S.  
 Curry Bros., & Bent, Bridgewater,  
     [N.S.

GENERAL LIST OF CANADIAN MANUFACTURERS.

Curry, Wm., & Son, Windsor, N.S.  
 Curry, W. H., & Co., Windsor, N.S.  
 Cushing, W. H., Calgary, N.W.T.  
 D'Amour & Dessaint, Hull, Que.  
 D'Amour & Monfils, Hull, Que.  
 Dand, Raymond, New Glasgow, N.S.  
 Daniels, W., Orangeville, Ont.  
 Dauplaise, P., St. Cyrille de  
 [Wendover, Que.  
 Davey, John, Bradford, Ont.  
 Davidson, Munro & Co., Peter-  
 [borough, Ont.  
 Davidson, G. H., Brighton, Ont.  
 Davidson, R., Niagara, Ont.  
 Davidson, J. E., & Co., Toronto, Ont.  
 Davidson & Barton, Toronto, Ont.  
 Davis & Elizerman, Mitchell, Ont.  
 Dempster, Jas., & Co., Halifax, N.S.  
 Dent, T., Cumminsville, Ont.  
 Desrivieres, A., Ottawa, Ont.  
 Desrosiers, A., Louiseville, Que.  
 Devine, J., Killaloe, Ont.  
 Dewar, Robert, Barney's River, N.S.  
 Dewett, W. N., & Co., St. John, N.B.  
 Dicks, J., Forwich, Ont.  
 Diehl Mfg. Co., (The), Toronto, Ont.  
 Dietrich, G., Ayton, Ont.  
 Dillingham, W. B., Quebec, Que.  
 Dinnis, R., & Son, Toronto, Ont.  
 Dixon, J., Landowne, Ont.  
 Doake, J. E., Doaktown, N.B.  
 Dodd, J. C., London, Ont.  
 Doherty, W., & Co., Clinton, Ont.  
 Dominion Piano & Organ Co.,  
 [Bowmanville, Ont.  
 Dominion Snath Co., (The),  
 [Waterville, Que.  
 Donell, J. R., Peterboro', Ont.  
 Donell, W., Peterboro', Ont.  
 Donnelly, P., Montreal, Que.  
 Doull, J. Wesley, Sackville, N.B.  
 Dowler Bros., Bracebridge, Ont.  
 Dowling & Leighton, Harriston, Ont.  
 Doxsee, Bros., Hastings, Ont.  
 Drysdale, William, Woodstock, N.B.  
 Dubreuil, A., Ste. Placide, Que.  
 Ducharme, Geo., & Co., Montreal, Q.  
 Dufferin Furniture & Novelty Co.,  
 [Toronto, Ont.  
 Dyer & Howard, Exeter, Ont.  
 Dyer, Frank, Tara, Ont.  
 Dumas, Thos., Eganville, Ont.  
 Dufresne, O., Jr., Montreal, Que.  
 Eaton, J. R., Orillia, Ont.  
 Eclipse Office Furniture Co., Ottawa,  
 [Ont.  
 Elderkin, C. J., St. John, N.B.  
 Elgie, Robt. B., Toronto, Ont.  
 Elliott, J., Prescott, Ont.  
 Ellis Furniture Co., Ingersoll, Ont.  
 Emmerson, H. R., Scotch Settlement,  
 [N.B.  
 Emerson & Fisher, St. John, N.B.  
 Ennis & Co., Hamilton, Ont.  
 Esplin, G. & J., Montreal, Que.  
 Eureka Refrigerator Co., Toronto, O.  
 Evans, A. J., Kincairdine, Ont.  
 Evans, P., Bondhead, Ont.  
 Evans, William, Jr., Hamilton, Ont.  
 Evans Bros., Piano Mfg. Co., Ltd.,  
 [Ingersoll, Ont.

Farrah, William, Shedden, Ont.  
 Fauteux, Hercule, Montreal, Que.  
 Ferguson, J., & Sons, London, Ont.  
**FIRSTBROOK BROS., Toronto, Ont.**  
**- Packing Cases, Dovè Mail Boxes,**  
**Cigar Boxes, Telegraph Cross Arms,**  
**Top Pins & Side Blocks, Wood Print-**  
**ers, &c.**  
 Fisher & Shaw, Bridgetown, N.S.  
 Fletcher, F. W., Toronto, Ont.  
 Fleming & Kemp, Sundbridge, Ont.  
 Flewwelling, G. & G., Mfg. Co., (The)  
 [Hampton, N.B.  
 Foisy, Thos. F. G., Piano Mfg. Co.,  
 (The), Montreal, Que.  
 Folding Sawing Machine Co., Essex,  
 [Ont.  
 Forbes, William, Toronto, Ont.  
 Ford & Co., Sudbury, Ont.  
 Foster & Lockston, Galt, Ont.  
 Fox & Co., Toronto, Ont.  
 Francis, L., Kingston, Ont.  
 Fraser, Jno., Amherstburgh, Ont.  
 Fraser, Wood, Mfg. Co., Thorald, O.  
 Frith, J. E., Princeton, Ont.  
 Fullerton, D., & Son, Pictou, N.S.  
 Fundlay & Lewis, Parry Sound, Ont.  
 Gagne, Domina, Montreal, Que.  
 Gagne, S., Ste. Anne de la Pocatiere,  
 [Que.  
 Gagnon, A., Ste. Anne des Plaines, Q.  
 Gagnon, J. B., Montreal, Que.  
 Galbraith & Sons, New Westminster.  
 Gardan, A., Dutton, Ont. [B.C.  
 Gardiner, J., Grand Valley, Ont.  
 Gardner Bros., & Co., Essex, Ont.  
 Gauthier & Lalonde, Montreal, Que.  
 Gaw, R., & Co., Kingston, Ont.  
 Gelinias, C. P., & Bros., Three Rivers,  
 [Que.  
 Georgian Bay Planing Mill, Midland,  
 Gerry, Wm., London, Ont. [Ont.  
 Gibbard Furniture Co., Ltd.,  
 [Napanee, Ont.  
 Giberson, J., Jr., Bristol, N.B.  
 Gibson, S., Lucan, Ont.  
 Giddins, H. F., & Co., Granby, Que.  
 Gignac, O., & Sons, Quebec, Que.  
 Gilchrist Bros., Toronto, Ont.  
 Giles, A. R., Ottawa, Ont.  
 Gille, Langelier, St. Paschal, Que.  
 Gillespie, M., & Co., Alvinston, Ont.  
 Gillies & Son, Ailsa Craig, Ont.  
 Gillis, Ronald, Sydney, N.S.  
 Gillet, Thomas, Mill Brook, Ont.  
 Gilmour, A. J., Toronto, Ont.  
 Gilmour, A. K., Arthur, Ont.  
 Gilpin, Thos., Wiarton, Ont.  
 Girard, Leopold, Three Rivers, Que.  
 Globe Casket Co., London, Ont.  
 Globe Furniture Co., Walkerville, O.  
 Goold, Shapley & Muir Co.,  
 [Brantford, Ont.  
 Gordon, W. W., Glencoe, Ont.  
 Gordon & Keith, Halifax, N.S.  
 Gordon, Wm., Udora, Ont.  
 Gosselin, Jos., Levis, Que.  
 Goulette, O. V., Gananoque, Ont.  
 Gow, John, Montreal, Que.  
 Goodman, Geo. A., Windsor, Ont.

Graham, Arthur, Mill Brook, Ont.  
 Graham, J. A., Brantford, Ont.  
 Graham, J. R., Elmvale, Ont.  
 Grant, Peter, Bobcaygeon, Ont.  
 Graydon, J., Jarvis, Ont.  
 Gray, George, Harriston, Ont.  
 Greason, Christopher, London, Ont.  
 Green, G. W., & Son, Kingsville, Ont.  
 Green, Edwin, Hamilton, Ont.  
 Green, J. M., & Co., St. Thomas, Ont.  
 Green, W., & Co., Napanee, Ont.  
 Greenwood, W. E., Toronto, Ont.  
 Grier, J., Madock, Ont.  
 Griffin, J., Lakefield, Ont.  
 Gross & Granger, Whitby, Ont.  
 Guerin, Remi, Montreal, Que.  
 Guilbert & Co., Magog, Que.  
 Hahn, Lewis, New Hamburg, Ont.  
 Haley, Wm., & Co., St. Stephen, N.B.  
 Hall, Henry G., Bolton Glen, Que.  
 Hall, W. E., Galt, Ont.  
 Hambleton & Co., Hampton, N.B.  
 Hamelin, Pierre & Co., Montreal, Q.  
 Hamilton Cigar Box & Packing Case  
 [Hamilton, Ont.  
 Hamilton Lumber Co., Hamilton, O.  
 Hamilton & Prout, Forest, Ont.  
 Hammond, W. H., Orillia, Ont.  
 Hanbury & McNea Mfg. Co., (The),  
 [Brandon, Man.  
 Hanover Furniture & Undertaking  
 [Co., Hanover, Ont.  
 Hart, Jeremiah, Wilfrid, Ont.  
 Hardy, E. C., Woodstock, Ont.,  
 Harel & Laroche, St. Bonaventure, Q.  
 Harriman, J., Niagara Falls, Ont.  
 Harrison, G. A., Bishop's Crossing, Q.  
 Harrison, John, Owen Sound, Ont.  
 Harrison & Willard, Dudswell, Que.  
 Harrison & Walton, Belleville, Ont.  
 Harvie & Co., Toronto, Ont.  
 Hawkins & Greer, Shelburne, Ont.  
 Haws & Matchett, St. Thomas, Ont.  
 Hayward, Chas., Victoria, B.C.  
 Hazleton, G., Douglas, Ont.  
 Head, Henry, Smithfield, Ont.  
 Heimbecker & Klinck, Elmira, Ont.  
 Heintzman & Co., Toronto, Ont.  
 Heintzman Gerhard Co., (The),  
 [Toronto, Ont.  
 Henderson, T. F., Leamington, Ont.  
 Henderson Bros., Montreal, Que.  
 Henderson Bros., Cobourg, Ont.  
 Henderson & Calhoun, Rockburn, Q.  
 Henderson & Parslow, Dundalk, Ont.  
 Hepburn, A. W., Pictou, Ont.  
 Heustis, J., Yarmouth, N.S.  
 Hewlett, M. C., Mfg., Co., (The),  
 [Toronto, Ont.  
 Hibner, D., & Co., Berlin, Ont.  
 Higginson, J. W., Hawkesbury, Ont.  
 Hilliard & McKinley, London, Ont.  
 Hill, John H., Fulton, Ont.  
 Hill, S., Markdale, Ont.  
 Hillock, John, & Co., Toronto, Ont.  
 Hodgson, W., & Son, Como, Que.  
 Hoerr, H. & F., Toronto, Ont.  
 Hogan, M. P., Charlottetown, P.E.I.  
 Holland, S., Elora, Ont.  
 Hood, Wm., & Son, Montreal, Que.



GENERAL LIST OF CANADIAN MANUFACTURERS.

- Hoodless, J., & Son, Hamilton, Ont.  
 Hooker & Co., Selkirk West, Man.  
 Hores, F. W., & Sons, Hamilton, Ont.  
 Hotel, S., Clifford, Ont.  
 Hourd & Co., London, Ont.  
 Houston, R. F., Tweed, Ont.  
 Housberge, Geo., Richard's Landing, [Ont.  
 Humphrey, Jno. A., Moncton, N.B.  
 Hussey, James J., Pugwash, N.S.  
 Ingle, G., Lindsay, Ont.  
 Inglewood Mfg. Co., Inglewood, Ont.  
 Innis, L., & Son, Richmond Hill, Ont.  
 Ives, W. H., Colborne, Ont.  
 Jack, William, De Cewsville, Ont.  
 Jackson, Jacob H., Hampton, N.B.  
 Jackson, W., Maple, Ont.  
 Jacob, M., Sebringville, Ont.  
 Jeffries, G., Lynedoch, Ont.  
 Jamerson, J. W., Wellandport, Ont.  
 Jenner, Thomas, Kingsville, Ont.  
 Jennings, G., Huntsville, Ont.  
 Jerrett, J., Alliston, Ont.  
 Joannisse, C., & Son, Buckingham,  
 Johnson Bros., Essex, Ont. [Que.  
 Johnson & Wright, St. Mary's, Ont.  
 Jones, E. G., Ottawa, Ont.  
 Jouron, D., Pont Viau, Que.  
 Karn, D. W., & Co., Woodstock, Ont.  
 Kaufman, Jacob, Berlin, Ont.  
 Keefe, P., Iroquois, Ont.  
 Kennedy, Davis & Son, Lindsay, O.  
 Kensington Furniture Co., London,  
 Kerr, G. A., Creemore, Ont. [Ont.  
 Kerr & Harcourt, Walkerton, Ont.  
 Kilgour Piano & Organ Co., [Hamilton, Ont.  
 King, S. S., Hamilton, Ont.  
 King & Yorston, Toronto, Ont.  
 Kinney-Haley Mfg. Co., Ltd., [Yarmouth, N.S.  
 Kippen, D., Perth, Ont.  
 Klein, A., Harriston, Ont.  
 Kneeland, S. K., Tangier, N.S.  
 Knight Bros., Burk's Falls, Ont.  
 Knott, C., Hamilton, Ont.  
 Knowles, Ham & Nott Co., [Brantford, Ont.  
 Kreiner, J., & Co., Berlin, Ont.  
 Kreutziger, Chas., Waterloo, Ont.  
 Krug, H., Berlin, Ont.  
 Krug Bros., & Co., Chesley, Ont.  
 Labbe, Geo. H., & Co., Montreal, Q.  
 Labelle, H. S., & Co., Montreal, Que.  
 Labelle, S., St. Jerome, Que.  
 Lafleur, O. B., Lachute, Que.  
 Laidlaw, R., & Co., Toronto, Ont.  
 Laing Bros., Essex, Ont.  
 Laird, J. A., Brampton, Ont.  
 Laird Bros., Dresden, Ont.  
 Laking, Thompson, Patterson & Co., [Hamilton, Ont.  
 Lalonde & Giard, Montreal, Que.  
 Lalonde, W., St. Clet, Que.  
 Lamarre & Co., St. Remi, Que.  
 Lalonde & Girard, Montreal, Que.  
 Lambkin, P. & L., Riceburg, Que.  
 Lapointe, C., Farnham, Que.  
 Large, J., Listowel, Ont.  
 Lariviere & Dube, Montreal, Que.  
 Lavigne, A., Montreal, Que.  
 Lawless, W. C., & Co., Montreal, Q.  
 Lawson & Wilson, Toronto, Ont.  
 Law, John, Melbourne, Que.  
 Lea, Paul, Moncton, N.B.  
 Leask Bros., Gore Bay, Ont.  
 Leclerc, J. E., L'Islet, Que.  
 Lecompte, E., Nicolet, Que.  
 Lefavre, R., Oka, Que.  
 Lefebvre, John, Robinson, Que.  
 Leger & Co., Montreal, Que.  
 Leith & McKinney, Horning's Mills, [Ont.  
 Lemay, Alphonse, Portneuf, Que.  
 Lemay, D., Lotbiniere, Que.  
 Lemay, Nap., St. Camille, Que.  
 Lemon, Gonnason & Co., Victoria,  
 Lennox, J., Jasper, Ont. [B.C.  
 Lennox & Co., Toronto, Ont.  
 Leonard, E., & Sons, Montreal, Que.  
 Lepine, Germain, Quebec, Que.  
 Lesage & Piche, Ste. Therese, Que.  
 Leslie, A. J., Mount Forest, Ont.  
 Levers, Chas., Huntingdon, Que.  
 Leveque, A., Village des Aulnais, Q.  
 Light, R., & Son, Napanee, Ont.  
 Lillicrap, J. F., & Co., Lakefield, O.  
 Lindop, Henry, St. Thomas, Ont.  
 Linton, W. J., Brantford, Ont.  
 Lippert, Schaefer & Co., Waterloo, [Ont.  
 Lloyd, C., & Son, Wingham, Ont.  
 London Furniture Mfg. Co., London, [Ont.  
 Long, George, Sherbrooke, Que.  
 Lordly, A. J., & Son, St. John, N.B.  
 Love, J., Picton, Ont.  
 Lovelace, W. D., Garthby, Que.  
 Lovering, H. L., & Co., Coldwater, O.  
 Lowe, John, Aylmer, Ont.  
 Ludlam & Ainslie, Comber, Ont.  
 Lunenburg Furniture Co., Ltd., (The) [Lunenburg, N.S.  
 Lye, Edward & Sons, Toronto, Ont.  
 Lyons, L., Wellington, Ont.  
 McAuslan, A., Galt, Ont.  
 McBee, A. A., St. John, N.B.  
 McCaffrey, D., Huntsville, Ont.  
 McCall & Mason, St. Williams, Ont.  
 McCallum, J., & Sons, Montreal, Que.  
 McCormick, Bros., Winnipeg, Man.  
 McCraig Bros., Portage la Prairie, [Man.  
 McCredie & Sons, Shawville, Que.  
 McCulla, W. A., Brampton, Ont.  
 McCurdy, Wilson & Hill, Truro, N.S.  
 McDonald, D., Orangeville, Ont.  
 McDonald, Edwd., N. Sydney, N.S.  
 McDonald, John, Chatham, N.B.  
 McDonald, J., Orangeville, Ont.  
 McDonald, James, Tilbury Centre, O.  
 McElmon, Jno. N., Dartmouth, N.S.  
 McGregor, D. C., Montreal, Que.  
 McGregor, W. A., & Son, Huntsville, [Ont.  
 McIlwrath & Clynick Bros., Wood- [stock, Ont.  
 McIntyre, Petetzkie, Eganville, Ont.  
 McKay, J., Paris, Ont.  
 McKee, Martin, Toronto, Ont.  
 McKenzie, T., Clinton, Ont.  
 McKenzie, A. J., & Co., Aylmer, Ont.  
 McLaurin, A. P., & Co., Lachine, Q.  
 McLaurin Bros., Montreal, Que.  
 McLean, James, Bryson, Que.  
 McLeod, K. A., Edmonton, N.W.T.  
 McLeod, N., Armstrong, B.C.  
 McLeod Bros., Truro, N.S.  
 McMillan & Costain, East Oro, Ont.  
 McMurchie, A., & Co., Clinton, Ont.  
 McNichol, J. & D., Renfrew, Ont.  
 McTavish & Co., Wingham, Ont.  
 Mabee & Co., St. John, N.B.  
 Macfarlane, Robert, Montreal, Que.  
 Macpherson & Schell, Alexandria, O.  
 Malcolm & Souter, Hamilton, Ont.  
 Malott, L., Kingsville, Ont.  
 Manchee, Wilson & Adamson, [Toronto, Ont.  
 Mantha, A., & Co., Montreal, Que.  
 Marsh, D., Grimsby, Ont.  
 Martin, J., Hillsdale, Ont.  
 Martin, Freres, Montreal, Que.  
 Martin & Jones, Kemptville, Ont.  
 Martin, M., Wallaceburg, Ont.  
 Mason & Risch, Toronto, Ont.  
 Mathieu, E., Beloeil, Que.  
 Matthews Bros., & Co., Toronto, Ont.  
 Maxwell, E. J., & Co., Montreal, Que.  
 Mendelssohn Piano Co., Toronto, O.  
 Mercier, T., Ste. Julie de Somerset, [Que.  
 Merkley, A. H., Morrisburg, Ont.  
 Merlin, Jas. C., Halifax, N.S.  
 Metler Bros., Fenwick, Ont.  
 Miles & Co., Toronto, Ont.  
 Miller, Jno. A., Avening, Ont.  
 Milling Co., (The), Mitchell, Ont.  
 Milne, W. A., Brown's Corners, Ont.  
 Milord & Co., Winnipeg, Man.  
 Mitchell, Louis, Montreal, Que.  
 Mitchell & Wilson, Gananoque, Ont.  
 Moffatt & Co., Carleton Place, Ont.  
 Moffatt & Co., Renfrew, Ont.  
 Moir & McCall, Toronto, Ont.  
 Moore, J. D., St. Mary's, Ont.  
 Moore, R. J., Lion's Head, Ont.  
 Moore, Thos., Chesley, Ont.  
 Morel & Morin, Montreal, Que.  
 Morin, E. P., South Stukely, Que.  
 Morin, L. P., St. Hyacinthe, Que.  
 Morin & Frere, Maisonneuve, Que.  
 Morris, Field, Rogers Co., (The), [Listowel, Ont.  
 Muirhead & Mann, Victoria, B.C.  
 Muir, J., Port Elgin, Ont.  
 Mundell, John, & Co., Elora, Ont.  
 Munro, D. A., Wolfville, N.S.  
 Munroe, W. A., Iroquois, Ont.  
 Munro, Wm., & Son, Toronto, Ont.  
 Murray, A., Planing Mill, Brantford, [Ont.  
 Murray, G. W., Winnipeg, Man.  
 Mustard, G., Creemore, Ont.  
 Nagle Bros., Ingersoll, Ont.  
 Nelson, W. F., Richmond, Que.  
 Newcombe, O., & Co., Toronto, Ont.  
 New York Mantel & Decorating Co., (The), Montreal, Que.  
 N. Y. Piano Co., (The), Montreal, Q.  
 Nichol, T. G., Mahone Bay, N.S.  
 Nichol Bros., Blenheim, Ont.



**GENERAL LIST OF CANADIAN MANUFACTURERS.**

Nichols, A., & Son, Carleton, Place, [Ont.]	Purdy, J., Manitowaning, Ont. Queen City Planing Mill, Victoria, [B.C.]	Selkirk Mfg. Co., Selkirk, Ont. Semmend & Evel, Hamilton, Ont. Shaver, W., Winchester, Ont. Shaw, John, Brigden, Ont. Shaw & Skuce, Omemee, Ont. Shaw, Geo., Sr., Thessalon, Ont. Shearer & Brown, Montreal, Que. Shearer, Jas., Montreal, Que. Shepherd, Chas. W., Sutton, Que. Shrimpton, H. M., London, Ont. Siemon & Bro. Mfg. Co., Wiarton, O. Simmons, Burpee & Co., Fredericton, [N.B.]
Noble, A., Bolton, Ont. Noble & Co., Toronto, Ont. Nordheimer, A. & S., Toronto, Ont. O'Connor, D., Jr., Ottawa, Ont. Office Specialty Mfg. Co., Toronto, O. Oliver & Son, Ottawa, Ont. Ontario Box Co., Hamilton, Ont. Orillia Machine & Moulding Co., [Orillia, Ont.]	Quehl, John H., Amulree, Ont. Ramer, I., Markham, Ont. Ranink, A., Barrie, Ont. Rankin & Co., Toronto, Ont. Rathbone, Geo., Toronto, Ont. Rathbun Co., (The), Deseronto, Ont. Rawlinson, L., Toronto, Ont. Reid, C., Bothwell, Ont. Reid & Thirsk, Uxbridge, Ont. Restigouche Spool Co., Jacquet River, [N.B.]	Simpson, Wm., Carrs Brook, N.S. Simpson, Wm., Toronto, Ont. Simpson, E., & Co., Moose Jaw, [N.W.T.]
Orr, Thos., & Son, Stratford, Ont. Ottawa Car Co., Ltd., (The), Ottawa, [Ont.]	Rheaume, N., & Bro., Montreal, Que. Rhodes, Curry & Co., Amherst, N.S. Richardson, Richard, & Son, [Bedford, N.S.]	Simpson Co., Ltd., (The), Berlin, O. Simpson & Sons, Mount Brydges, O. Slater & Douglas, Toronto, Ont. Sloan, J. B., Eugenia, Ont. Smeath, F., Goderich, Ont. Smedley, Thomas, Amigari, Ont. Smedley, T., Fort Erie, Ont. Smith, Albert C., Lunenburg, N.S. Smith, A. J., Victoria, B.C. Smith, G. M., Aylmer, Ont. Smith, John E., Hoyt Station, N.B. Smith, J., Morpetah, Ont. Smith, J., Ripley, Ont. Smith & Grant, London, Ont. Smith, J. B., & Sons, Toronto, Ont. Smith & Russell, Alton, Ont. Smith, W. P., & Co., Toronto, Ont. Smith, Oliver, Wroxeter, Ont. Snellgrove, James, Peaverton, Ont. Snider, John B., Waterloo, Ont. Snowball Wagon Co., St. George, O. Snyder, Roos & Co., Waterloo, Ont. Somerville, John, Milton, Ont. Somerville, J. L., Pickering, Ont. Songster, J., London, Ont. Spanner, Walter, Toronto, Ont. Sparling, J., Meaford, Ont. Spencer, E., & Co., Parrsboro', N.S. Spencer, Turner & Logan, Truro, N.S. Stafford, B. V., Arnprior, Ont. Stafford & Rudd, Arnprior, Ont. Standard Piano Co. of Toronto, Ltd., (The)
Otterville Mfg. Co., Ltd., Otterville, Owen, J. R., Ridgetown, Ont. [Ont.]	Risteen, Jos. C., & Co., [Fredericton, N.B.]	Simpson Co., Ltd., (The), Berlin, O. Simpson & Sons, Mount Brydges, O. Slater & Douglas, Toronto, Ont. Sloan, J. B., Eugenia, Ont. Smeath, F., Goderich, Ont. Smedley, Thomas, Amigari, Ont. Smedley, T., Fort Erie, Ont. Smith, Albert C., Lunenburg, N.S. Smith, A. J., Victoria, B.C. Smith, G. M., Aylmer, Ont. Smith, John E., Hoyt Station, N.B. Smith, J., Morpetah, Ont. Smith, J., Ripley, Ont. Smith & Grant, London, Ont. Smith, J. B., & Sons, Toronto, Ont. Smith & Russell, Alton, Ont. Smith, W. P., & Co., Toronto, Ont. Smith, Oliver, Wroxeter, Ont. Snellgrove, James, Peaverton, Ont. Snider, John B., Waterloo, Ont. Snowball Wagon Co., St. George, O. Snyder, Roos & Co., Waterloo, Ont. Somerville, John, Milton, Ont. Somerville, J. L., Pickering, Ont. Songster, J., London, Ont. Spanner, Walter, Toronto, Ont. Sparling, J., Meaford, Ont. Spencer, E., & Co., Parrsboro', N.S. Spencer, Turner & Logan, Truro, N.S. Stafford, B. V., Arnprior, Ont. Stafford & Rudd, Arnprior, Ont. Standard Piano Co. of Toronto, Ltd., (The)
Owen Sound Steam Saw & Planing Mills, Owen Sound, Ont. Oxford Furniture Co., Ltd., Oxford, [N.S.]	Robertson & Hackett, Vancouver, [B.C.]	Simpson Co., Ltd., (The), Berlin, O. Simpson & Sons, Mount Brydges, O. Slater & Douglas, Toronto, Ont. Sloan, J. B., Eugenia, Ont. Smeath, F., Goderich, Ont. Smedley, Thomas, Amigari, Ont. Smedley, T., Fort Erie, Ont. Smith, Albert C., Lunenburg, N.S. Smith, A. J., Victoria, B.C. Smith, G. M., Aylmer, Ont. Smith, John E., Hoyt Station, N.B. Smith, J., Morpetah, Ont. Smith, J., Ripley, Ont. Smith & Grant, London, Ont. Smith, J. B., & Sons, Toronto, Ont. Smith & Russell, Alton, Ont. Smith, W. P., & Co., Toronto, Ont. Smith, Oliver, Wroxeter, Ont. Snellgrove, James, Peaverton, Ont. Snider, John B., Waterloo, Ont. Snowball Wagon Co., St. George, O. Snyder, Roos & Co., Waterloo, Ont. Somerville, John, Milton, Ont. Somerville, J. L., Pickering, Ont. Songster, J., London, Ont. Spanner, Walter, Toronto, Ont. Sparling, J., Meaford, Ont. Spencer, E., & Co., Parrsboro', N.S. Spencer, Turner & Logan, Truro, N.S. Stafford, B. V., Arnprior, Ont. Stafford & Rudd, Arnprior, Ont. Standard Piano Co. of Toronto, Ltd., (The)
Pacific Sash & Door Factory, [Vancouver, B.C.]	Robertson & Smillie, Maxville, Ont. Robert, J., & Fils, Montreal, Que. Robicheau, Jno. L., Metaghan, N.S. Robinson, Wm., Camlachie, Ont. Rochette, Georgina, Lachute Mills, [Que.]	Simpson Co., Ltd., (The), Berlin, O. Simpson & Sons, Mount Brydges, O. Slater & Douglas, Toronto, Ont. Sloan, J. B., Eugenia, Ont. Smeath, F., Goderich, Ont. Smedley, Thomas, Amigari, Ont. Smedley, T., Fort Erie, Ont. Smith, Albert C., Lunenburg, N.S. Smith, A. J., Victoria, B.C. Smith, G. M., Aylmer, Ont. Smith, John E., Hoyt Station, N.B. Smith, J., Morpetah, Ont. Smith, J., Ripley, Ont. Smith & Grant, London, Ont. Smith, J. B., & Sons, Toronto, Ont. Smith & Russell, Alton, Ont. Smith, W. P., & Co., Toronto, Ont. Smith, Oliver, Wroxeter, Ont. Snellgrove, James, Peaverton, Ont. Snider, John B., Waterloo, Ont. Snowball Wagon Co., St. George, O. Snyder, Roos & Co., Waterloo, Ont. Somerville, John, Milton, Ont. Somerville, J. L., Pickering, Ont. Songster, J., London, Ont. Spanner, Walter, Toronto, Ont. Sparling, J., Meaford, Ont. Spencer, E., & Co., Parrsboro', N.S. Spencer, Turner & Logan, Truro, N.S. Stafford, B. V., Arnprior, Ont. Stafford & Rudd, Arnprior, Ont. Standard Piano Co. of Toronto, Ltd., (The)
Painchaud, R. E., Montreal, Que. Pallascio, (Estate) G., Montreal, Q. Palmer, R., & Co., Charlottetown, [P.E.I.]	Rock, C. C., Brodhagen, Ont. Rock, J. G., Brodhagen, Ont. Rogers, Chas., & Sons Co., Ltd. (The) [Toronto, Ont.]	Simpson Co., Ltd., (The), Berlin, O. Simpson & Sons, Mount Brydges, O. Slater & Douglas, Toronto, Ont. Sloan, J. B., Eugenia, Ont. Smeath, F., Goderich, Ont. Smedley, Thomas, Amigari, Ont. Smedley, T., Fort Erie, Ont. Smith, Albert C., Lunenburg, N.S. Smith, A. J., Victoria, B.C. Smith, G. M., Aylmer, Ont. Smith, John E., Hoyt Station, N.B. Smith, J., Morpetah, Ont. Smith, J., Ripley, Ont. Smith & Grant, London, Ont. Smith, J. B., & Sons, Toronto, Ont. Smith & Russell, Alton, Ont. Smith, W. P., & Co., Toronto, Ont. Smith, Oliver, Wroxeter, Ont. Snellgrove, James, Peaverton, Ont. Snider, John B., Waterloo, Ont. Snowball Wagon Co., St. George, O. Snyder, Roos & Co., Waterloo, Ont. Somerville, John, Milton, Ont. Somerville, J. L., Pickering, Ont. Songster, J., London, Ont. Spanner, Walter, Toronto, Ont. Sparling, J., Meaford, Ont. Spencer, E., & Co., Parrsboro', N.S. Spencer, Turner & Logan, Truro, N.S. Stafford, B. V., Arnprior, Ont. Stafford & Rudd, Arnprior, Ont. Standard Piano Co. of Toronto, Ltd., (The)
Paquet & Godbout, Montreal, Que. Paquet & Godbout, St. Hyacinthe, Q. Paquette, Arthur, Montreal, Que. Paquette, Jos., Montreal, Que. Paquette, Stanislas, Montreal, Que. Parizeau, Stanislas, Montreal, Que. Parkdale Wooden Ware Co., Toronto, [Ont.]	Rogers & Edgeworth, Stevensville., O. Rompre & Co., Ste. Anne de la [Perade, Que.]	Simpson Co., Ltd., (The), Berlin, O. Simpson & Sons, Mount Brydges, O. Slater & Douglas, Toronto, Ont. Sloan, J. B., Eugenia, Ont. Smeath, F., Goderich, Ont. Smedley, Thomas, Amigari, Ont. Smedley, T., Fort Erie, Ont. Smith, Albert C., Lunenburg, N.S. Smith, A. J., Victoria, B.C. Smith, G. M., Aylmer, Ont. Smith, John E., Hoyt Station, N.B. Smith, J., Morpetah, Ont. Smith, J., Ripley, Ont. Smith & Grant, London, Ont. Smith, J. B., & Sons, Toronto, Ont. Smith & Russell, Alton, Ont. Smith, W. P., & Co., Toronto, Ont. Smith, Oliver, Wroxeter, Ont. Snellgrove, James, Peaverton, Ont. Snider, John B., Waterloo, Ont. Snowball Wagon Co., St. George, O. Snyder, Roos & Co., Waterloo, Ont. Somerville, John, Milton, Ont. Somerville, J. L., Pickering, Ont. Songster, J., London, Ont. Spanner, Walter, Toronto, Ont. Sparling, J., Meaford, Ont. Spencer, E., & Co., Parrsboro', N.S. Spencer, Turner & Logan, Truro, N.S. Stafford, B. V., Arnprior, Ont. Stafford & Rudd, Arnprior, Ont. Standard Piano Co. of Toronto, Ltd., (The)
Park & Borrowman, Amherstburg, Parr, J. A., Ottawa, Ont. [Ont.]	Rookledge, Geo. G., Victoria, B.C. Rose, James A., Kingsey Falls, Que. Ross, L. A., Cornwall, Ont. Ross & Taylor, Exeter, Ont. Roy, M., Warwick, Que. Roy, D., & Frere, Levis, Que. Roy & Leeder, Quyon, Que. Rutherford, Wm., & Sons, Montreal, Ryley, J. P., Lindsay, Ont. [Que.]	Simpson Co., Ltd., (The), Berlin, O. Simpson & Sons, Mount Brydges, O. Slater & Douglas, Toronto, Ont. Sloan, J. B., Eugenia, Ont. Smeath, F., Goderich, Ont. Smedley, Thomas, Amigari, Ont. Smedley, T., Fort Erie, Ont. Smith, Albert C., Lunenburg, N.S. Smith, A. J., Victoria, B.C. Smith, G. M., Aylmer, Ont. Smith, John E., Hoyt Station, N.B. Smith, J., Morpetah, Ont. Smith, J., Ripley, Ont. Smith & Grant, London, Ont. Smith, J. B., & Sons, Toronto, Ont. Smith & Russell, Alton, Ont. Smith, W. P., & Co., Toronto, Ont. Smith, Oliver, Wroxeter, Ont. Snellgrove, James, Peaverton, Ont. Snider, John B., Waterloo, Ont. Snowball Wagon Co., St. George, O. Snyder, Roos & Co., Waterloo, Ont. Somerville, John, Milton, Ont. Somerville, J. L., Pickering, Ont. Songster, J., London, Ont. Spanner, Walter, Toronto, Ont. Sparling, J., Meaford, Ont. Spencer, E., & Co., Parrsboro', N.S. Spencer, Turner & Logan, Truro, N.S. Stafford, B. V., Arnprior, Ont. Stafford & Rudd, Arnprior, Ont. Standard Piano Co. of Toronto, Ltd., (The)
Patterson & Robt., Robertson's St'n, [Que.]	St. Louis of Mile End, Montreal, Que. Sandford, F., Fenelon Falls, Ont. Sargent, Isaac, London, Ont. Scarfe Bros., & Co., Dartmouth, N.S. Schabacker, Lawrie & Mortimore, [London, Ont.]	Simpson Co., Ltd., (The), Berlin, O. Simpson & Sons, Mount Brydges, O. Slater & Douglas, Toronto, Ont. Sloan, J. B., Eugenia, Ont. Smeath, F., Goderich, Ont. Smedley, Thomas, Amigari, Ont. Smedley, T., Fort Erie, Ont. Smith, Albert C., Lunenburg, N.S. Smith, A. J., Victoria, B.C. Smith, G. M., Aylmer, Ont. Smith, John E., Hoyt Station, N.B. Smith, J., Morpetah, Ont. Smith, J., Ripley, Ont. Smith & Grant, London, Ont. Smith, J. B., & Sons, Toronto, Ont. Smith & Russell, Alton, Ont. Smith, W. P., & Co., Toronto, Ont. Smith, Oliver, Wroxeter, Ont. Snellgrove, James, Peaverton, Ont. Snider, John B., Waterloo, Ont. Snowball Wagon Co., St. George, O. Snyder, Roos & Co., Waterloo, Ont. Somerville, John, Milton, Ont. Somerville, J. L., Pickering, Ont. Songster, J., London, Ont. Spanner, Walter, Toronto, Ont. Sparling, J., Meaford, Ont. Spencer, E., & Co., Parrsboro', N.S. Spencer, Turner & Logan, Truro, N.S. Stafford, B. V., Arnprior, Ont. Stafford & Rudd, Arnprior, Ont. Standard Piano Co. of Toronto, Ltd., (The)
Paterson & Robt., St. Catharines, O. Patterson & Co., Winnipeg, Man. Paul, J., Newboro', Ont. Paul Bros., Midland, Ont. Pearce, W. H., Forest, Ont. Peacock Bros., Hamilton, Ont. Peacock, Daniel, Woodstock, Ont. People's Planing Mill Co., (The), [Georgetown, Ont.]	Schack, C., & Co., Toronto, Ont. Schade, J., Magnetawan, Ont. Scholey Bros., Toronto, Ont. Schomberg Furniture Co., Toronto, O Schuler, C., Hamilton, Ont. Schultz, B. J., & Co., Dutton, Ont. Schultz Bros., Brantford, Ont. Scott, Jas. C., Toronto, Ont. Scott, John, Hamilton, Ont. Scott, W. G., Dunneville, Ont. Scott, W. & F. A., Galt, Ont. Scott, W., & Sons, Montreal, Que. Scott, Cross & Co., Toronto, Ont. Scott & Grant, Paisley, Ont. Scott, Lawton & Love, St. John, N.B. Scribner Organ Mfg. Co., London, O. Seaman, Kent & Co., Toronto, Ont. Searles, T. C., Hamilton, Ont. Sehl-Hastie-Erskine Furniture Co., Ltd., (The), Victoria, B.C.	Simpson Co., Ltd., (The), Berlin, O. Simpson & Sons, Mount Brydges, O. Slater & Douglas, Toronto, Ont. Sloan, J. B., Eugenia, Ont. Smeath, F., Goderich, Ont. Smedley, Thomas, Amigari, Ont. Smedley, T., Fort Erie, Ont. Smith, Albert C., Lunenburg, N.S. Smith, A. J., Victoria, B.C. Smith, G. M., Aylmer, Ont. Smith, John E., Hoyt Station, N.B. Smith, J., Morpetah, Ont. Smith, J., Ripley, Ont. Smith & Grant, London, Ont. Smith, J. B., & Sons, Toronto, Ont. Smith & Russell, Alton, Ont. Smith, W. P., & Co., Toronto, Ont. Smith, Oliver, Wroxeter, Ont. Snellgrove, James, Peaverton, Ont. Snider, John B., Waterloo, Ont. Snowball Wagon Co., St. George, O. Snyder, Roos & Co., Waterloo, Ont. Somerville, John, Milton, Ont. Somerville, J. L., Pickering, Ont. Songster, J., London, Ont. Spanner, Walter, Toronto, Ont. Sparling, J., Meaford, Ont. Spencer, E., & Co., Parrsboro', N.S. Spencer, Turner & Logan, Truro, N.S. Stafford, B. V., Arnprior, Ont. Stafford & Rudd, Arnprior, Ont. Standard Piano Co. of Toronto, Ltd., (The)
Percival, Wm., Sawyerville, Que. Peterkin, C. R., Toronto, Ont. Peters, F. A., Jr., St. John, N.B. Peters, Simon, Quebec, Que. Phelan, Jas., & Son, Arthur, Ont. Phillips, Geo. H., Aurora, Ont. Phillips, T., & Co., Orillia, Ont. Phillon, A. N., Ottawa, Ont. Philp & Eckardt, Toronto, Ont. Picard, A. G., Quebec, Que. Picard, L., St. Hyacinthe, Que. Piggott, John, Chatham, Ont. Piggott, J., & Sons, Windsor, Ont. Pink, W. J., Perth, Ont. Platt, J., Cookstown, Ont. Playfair, J., Baldu, Man. Pope, George, Hamilton, Ont. Poth & Krampire, New Dundee, O. Pratte Piano Co., (The), Montreal, Q. Prefontaine, Thos., Valleyfield, Que. Preston Furniture Co., Preston, Ont. Pringle, A., Belfountain, Ont. Pringle, A. N., Belleville, Ont. Provost, H., & Co., Maisonneuve, Q.	Selkirk Mfg. Co., Selkirk, Ont. Semmend & Evel, Hamilton, Ont. Shaver, W., Winchester, Ont. Shaw, John, Brigden, Ont. Shaw & Skuce, Omemee, Ont. Shaw, Geo., Sr., Thessalon, Ont. Shearer & Brown, Montreal, Que. Shearer, Jas., Montreal, Que. Shepherd, Chas. W., Sutton, Que. Shrimpton, H. M., London, Ont. Siemon & Bro. Mfg. Co., Wiarton, O. Simmons, Burpee & Co., Fredericton, [N.B.]	Simpson, Wm., Carrs Brook, N.S. Simpson, Wm., Toronto, Ont. Simpson, E., & Co., Moose Jaw, [N.W.T.]

## GENERAL LIST OF CANADIAN MANUFACTURERS.

Taylor, Wm., Hammond Plains, N.S.  
 Taylor, E. & A., Cumberland Mills, Q.  
 Taylor Bros., Sutton West, Ont.  
 Tees & Co., Montreal, Que.  
 Telford Bros., Drumbo, Ont.  
 Tessier, A., Penetanguishene, Ont.  
 Thackray, Robert, Ottawa, Ont.  
 Thackray & Rawlin, Pembroke, Ont.  
 Thomas, C. H., & Co., Fredericton, [N.B.]  
 Thomas, C. L., (Est. of) Hamilton, O.  
 Thomas Organ Co., Woodstock, Ont.  
 Thompson, A., Hamilton, Ont.  
 Thompson & Co., Sherbrooke, Que.  
 Thompson, D. W., & Co., Toronto, O.  
 Thompson, John, Vallentyne, Ont.  
 Throop, Wm., Spencerville, Ont.  
 Tickell, G. S., & Sons, Belleville, O.  
 Tierney, Jas. B., Blyth, Ont.  
 Todd, J., Collingwood, Ont.  
 Tombyll, R. N., Montreal, Que.  
 Toronto Show Case Co., (The), [Toronto, Ont.]  
 Toronto Planing Mill Co., Ltd., [Toronto, Ont.]  
 Tremaine, Arthur & Co., Montreal, Q.  
 Tremblay, Ferdinand, Montreal, Qu.  
 Tremblay, J. B., & Co., St. Henri, Q.  
 Trenholm, W. C., Port Elgin, N.B.  
 Trick, J., Port Hope, Ont.  
 Trudeau, J. N., Montreal, Que.  
 Trudeau, Pierre, Montreal, Que.  
 True, George E., Lower Southamp-  
 [ton, N.B.]  
 Truro Casket Co., Ltd., Truro, N.S.  
 Turcot, A. D., & Co., Montreal, Que.  
 Turner, D., Stayner, Ont.  
 Tuttle, A. A., Moncton, N.B.  
 Uxbridge Piano & Organ Co., [Uxbridge, Ont.]  
 Union Furniture & Merchandise Co., [Ltd., Bass River, N.S.]  
 Valliere, P., Quebec, Que.  
 Valiquette, M., Ottawa, Ont.  
 Valley City Seating Co., Dundas, O.  
 Vankleek Hill Mfg. Co., Vankleek  
 [Hill, Ont.]  
 Vancouver Sash & Door Co., Ltd., [Vancouver, B.C.]  
 Vansickle, W. T., Elmvale, Ont.  
 Van Wyck, A. K., Park Hill, Ont.  
 Victoria Wheel Works, Galt, Ont.  
 Waddell, J., Orno, Ont.  
 Watt, John, Wingham, Ont.  
 Wait, J. S., St. George, Ont.  
 Walker, Sons & Co., Walkerville, O.  
 Wand, William, Peterboro', Ont.  
 Wardle, J., Port Dover, Ont.  
 Warren, S. R., & Co., Toronto, Ont.  
 Wastell, A. M., & Co., Hamilton, Ont.  
 Watson & Malcolm, Kincardin, Ont.  
 Watson & Whimster, Portage la  
 [Prairie, Man.]  
 Watson's Box Factory, London, Ont.  
 Waugh & Robertson, Niagara Falls.  
 Way, A., Demorestville, Ont. [Ont.]  
 Weaver, A. S., Hamilton, Ont.  
 Weber, G. M., & Co., Kingston, Ont.  
 Weiderhold & Honderich, Milverton,  
 Welsh, W., Hensall, Ont. [Ont.]  
 Werner, John, Mildmay, Ont.

Weston, G. H., Marbleton, Que.  
 Whitcomb, N. L., Dunham, Que.  
 White, W. G., Glen Murray, Que.  
 White & Begg, Hawkesbury, Ont.  
 White & Proctor, Caledon East, Ont.  
 White, John J., Wheatley, Ont.  
 Wienert, E., Toronto, Ont.  
 Williams, C. B., Toronto, Ont.  
 Williams, R. S., & Sons Co., (The), [Toronto, Ont.]  
 Winslow, C., Delhi, Ont.  
 Wilson, H., Nile, Ont.  
 Wilson Bros., Colingwood, Ont.  
 Woltz & McMahon, Toronto, Ont.  
 Woodburn Sarven Wheel Co., St.  
 [Catharines, Ont.]  
 Woodstock Wood Marking Factory,  
 [Woodstock, N.B.]  
 Wooldridge, M., Palmerston, Ont.  
 Wormwith, W., & Co., Kingston, O.  
 Wray, R. M., Toronto, Ont.  
 Wright Bros., Alliston, Ont.  
 Wright, Mark & Co., Charlottetown,  
 [P.E.I.]  
 Wrigley Bros., Toronto, Ont.  
 Wyman, Jos. B., Milton, N.S.  
 Yerex, W. E., Little Britain, Ont.  
 Yench, Walter, Waterford, Ont.  
 York & Barrie, Chesterville, Ont.  
 Young, Peter, Almonte, Ont.  
 Young & Co., Toronto, Ont.  
 Zoellner, E. F. R., Mount Forest, O.

### MANUFACTURERS. — Woolen

(See also Knitted Goods and Hosiery in  
 classified list).

Adams, I. F., & Son, Tracey's Mills,  
 [N.B.]  
 Albrit, M., Merritton, Ont.  
 Allen & Son, Plantagenet, Ont.  
 Almonte Blanket Co., Almonte, Ont.  
 Alport, D., Smith's Falls, Ont.  
 Anderson, Geo. M., Joliette, Que.  
 Asselstine, Michael, Asselstine, Ont.  
 Auburn Woolen Co., Peterboro', Ont.  
 Bain, John J., Elora, Ont.  
 Baird, John (Est. of), Almonte, Ont.  
 Barber, M. G., Port Elgin, Ont.  
 Barington Woolen Mills, Barring'on,  
 [N.S.]  
 Barrows, A. R., Guelph, Ont.  
 Battey & Taylor, McKeller, Ont.  
 Beauchemin, L. & P., Chatillon, Que.  
 Beauchemin & Lupien, Chatillon, Q.  
 Beaudet, S., St. Philomene, Que.  
 Beaudoin, H., St. Evariste de  
 [Forsyth, Que.]  
 Bellerby, Chas., Shelburne, Ont.  
 Bernard, Jos., St. Charles, Que.  
 Bernard, M., St. Raphael, Que.  
 Berry, M. B., Quebec, Que.  
 Bird, Henry J., Bracebridge, Ont.  
 Black, J. & G., Thurso, Que.  
 Blair, T., Clayton, Ont.  
 Booth, B. A., Odeasa, Ont.  
 Bourre, H., St. Antoine de Tilly, Que.  
 Bowerman, A. A., Port Perry, Ont.  
 Bradbury & Co., Ingersoll, Ont.  
 Breeze, W., Forest Mills, Ont.  
 Briggs Bros., Stayner, Ont.

Brine, Henry K., Antigonishe, N.S.  
 Brodie & Co., Hespeler, Ont.  
 Brook, B. F., & Son, Listowel, Ont.  
 Brook Woolen Co., Simcoe, Ont.  
 Brown, David, Walter's Falls, Ont.  
 Brown, John, Horning's Mills, Ont.  
 Brown, W. & C., Keenansville, Ont.  
 Brown & Wigle, Kingsville, Ont.  
 Brubacher, H. M., Baden, Ont.  
 Bulmer, Geo. N., Sackville, N.B.  
 Burritt, A., & Co., Mitchell, Ont.  
 Cadorette, Michel, St. Hyacinthe, Q.  
 Caldwell, T. B., Lanark, Ont.  
 Caldwell, Boyd & Co., Lanark, Ont.  
 Cameron Bros., Cranbrook, Ont.  
 Canada Garnetting Co., Ltd., [Montreal, Que.]  
 Canadian Colored Cotton Mills Co., [Cornwall, Ont.]  
 Carscaden Bros., Russell, Ont.  
 Carter, S., Guelph, Ont.  
 Carter & Wootton, Guelph, Ont.  
 Cartlidge, Joseph, & Son, Guelph, O.  
 Cassavant, L., Lawrenceville, Que.  
 Chambers, D., Mill Brook, Ont.  
 Chase, J., Paisley, Ont.  
 Childerhouse, John, Eganville, Ont.  
 Chisholm, William C., Loch Lomond,  
 [N.S.]  
 Christie, W., Winchester, Ont.  
 Clarke, William, W. Flamboro, Ont.  
 Clark & Carman, St. Mary's Ont.  
 Clark, J., Westport, Ont.  
 Cliff, Altona, Ont.  
 Cobourg Woolen Co., Cobourg, Ont.  
 Code, T. A., Perth, Ont.  
 Collins, T. C., Effingham, Ont.  
 Comstock, W. S., Smith's Falls, Que.  
 Cook, John, & Son, Gay's River, N.S.  
 Corbin, Wm., Corbin, Que.  
 Cornwall Mfg. Co., Cornwall, Ont.  
 Crawford, E. & E. S., Guelph, Ont.  
 Creelman, James, & Son, Upper  
 [Stewiack, N.S.]  
 Groff, W., & Sons, Jamieson, Ont.  
 Cronkhite, Bros., Wiawasa, Ont.  
 Crosby, William, Morden, Man.  
 Cummings, J., Norwood, Ont.  
 Curry, John, River Louison, N.B.  
 Dalglish, George, Ottawa, Ont.  
 Dallaire, A., St. Samuel de Gayhurst,  
 [Que.]  
 Damboise, P., St. Paschal, Que.  
 Danford, S. J., Madoc, Ont.  
 Daniel, F. C. & Co., Toronto, Ont.  
 Decarufel, A. S., Pont de Maskin-  
 [onge, Que.]  
 Delisle, A. & G. I., Yamachiche, Que.  
 Dewitt, W. G., Hawkesbury, Ont.  
 Dickson, Alex., Arkona, Ont.  
 Dickson, J., & Son, Goderich, Ont.  
 Dion, C., Ste. Marguerite, Que.  
 Dobson & Co., Cannington, Ont.  
 Dontigny & Hughton, Arnprior, Ont.  
 Douglas, R., Cavanville, Ont.  
 Doyon, John, St. Elizear, Que.  
 Dufton, S. E., London, Ont.  
 Dugas, Jos., St. Jacques L'Achigan,  
 [Que.]  
 Duncan, W. S., Stratford, Ont.  
 Earnshaw, E., Port Stanley, Ont.

GENERAL LIST OF CANADIAN MANUFACTURERS.

Eastman, J. M., Loch Winnoek, Ont.  
 Eastwood, Elmer, Baltimore, Ont.  
 Elliott, T. C., Peterboro', Ont.  
 Ellis, C. S., Sarnia, Ont.  
 Elmsdale Flannel Mills, Almonte, O.  
 Fairweather, C. D., Kingston (Kings),  
 [N.B.]  
 Falla, S., Fallbrook, Ont.  
 Falt, J. W., & Son, Antigonishe, N.S.  
 Ferguson, J. B., Innisville, Ont.  
 Ferguson & Pattinson, Preston, Ont.  
 Fisher, D., Paisley, Ont.  
 Fisher & Co., Alliston, Ont.  
 Forbes, R., Co., Ltd. (The), Hespeler,  
 [Ont.]  
 Forsythe, Jas., Wroxeter, Ont.  
 Foster, Thomas R., Tara, Ont.  
 Franklin, B., Newcomb Mills, Ont.  
 Frappier, Jos., Ste. Julienne, Que.  
 Fraser, Donlas B., Almonte, Ont.  
 Fuller, D., Bancroft, Ont.  
 Gagnon, B., Jr., West Broughton, Q.  
 Garipey, N., St. Paul's Bay, Que.  
 Garrett, Henry, Kentville, N.S.  
 Gemmell, R., & Son, Perth, Ont.  
 Germain, A., Glen Morris, Ont.  
 Gilbert, Jos., St. Bruno, Que.  
 Gillies, Son & Co., Carleton Place, O.  
 Gilmore Woolen Mills, (The), Joliette,  
 [Que.]  
 Gingrich, N. W., St. Jacob's, Ont.  
 Gledhill, J., Beumiller, Ont.  
 Globe Woolen Mills Co., Montreal, Q.  
 Godreau, N., Beauvillage, Que.  
 Goodman, J., Minden, Ont.  
 Gordon, James, Athens, Ont.  
 Gosselin, P., St. Victor de Tring, Q.  
 Graham, J., Laskay, Ont.  
 Graham, D., Sons & Co., Inglewood,  
 [Ont.]  
 Granite Mills, St. Hyacinthe, Que.  
 Grant & Co., Chesley, Ont.  
 Green, D. W. G., Lyndhurst, Ont.  
 Green, P. S., Carlisle, O., (Wentworth)  
 Green, P. S., Progressstown, Ont.  
 Griffith & Matheson, Park Hill, Ont.  
 Grimsdale, H. H., West Brome, Que.  
 Grindrod, A. L., & Co., Sherbrooke, Q.  
 Gross, H. E., & Co., Moncton, N.B.  
 Guelph Woolen Mills Co., Ltd.,  
 [Guelph, Ont.]  
 Haigh, G., & Co., Mount Albert.  
 Hall, John, Trenholm, Que.  
 Hall, J., Huntsville, Ont.  
 Hamelin & Ayers, Lachute Mills, Q.  
 Hamel, C., St. Ephrem de Tring, Que.  
 Hamilton, Jas., & Sons, Eight Mile  
 [Brook, N.S.]  
 Hanson, J. D., Hull, Que.  
 Harcourt, Jas., New Glasgow, Que.  
 Harlow, Alfd., Sable River, N.S.  
 Harris & Co., Rockwood, Ont.  
 Hawthorn Woolen Co., (The),  
 [Carleton Place, Ont.]  
 Hay, G. S., St. Andre Avelin, Que.  
 Hepworth, James R., Lancaster, Ont.  
 Hepworth, T. L., St. Polycarpe, Que.  
 Hern, J., Orillia, Ont.  
 Hodgins, A., Shawville, Que.  
 Hodge, Wm., Cornwall, Ont.

Hodgson, J. J., Hudson, Que.  
 Holmes, Thos., Rothesay, Ont.  
 Horne Bros., Lindsay, Ont.  
 Horn, Wm., North Sydney, N.S.  
 Hubner & Cuninghame, Canning, Ont.  
 Humphrey, John A., & Son, Moncton,  
 [N.B.]  
 Hunter & Harvey, Frelighsburg, Que.  
 Hunt, J., Erin, Ont.  
 Jackel, A., Miidland, Ont.  
 Johnson & Sor, Ways' Mills, Que.  
 Johnston, E. K., New Annan, N.S.  
 Johnson, T. & M., Zurich, Ont.  
 Kaiser, E., & Muller, Montreal, Que.  
 Kerr Bros., Rocklin, N.S.  
 Kier, W. L., Campbellford, Ont.  
 Kingsville Woolen Mill Co., Kings-  
 [ville, Ont.]  
 Lachance & Cote, Ste. Adele, Que.  
 Laforce, Jos., Ste. Monique, Que.  
 Larlee, Amos H., Perth Centre, N.B.  
 Laroche, O. P., Maple Grove, Que.  
 Larocque, J. C., St. Jerome, Que.  
 Lazier, Jas. A., Napanee, Ont.  
 Leclerc, B., Carleton, Que.  
 Lees & Duglass, Lucknow, Ont.  
 Lees, Wm., Walsingham Centre, O.  
 Lefebvre, C. A., La Prairie, Que.  
 Lefebvre, J., St. Johns, Que.  
 Lindsay Woolen Mills, Lindsay, Ont.  
 Logan Bros., Renfrew, Ont.  
 Lomas, Adam, & Son, Sherbrooke, Q.  
 Lott, William, Belleville, Ont.  
 Louks, S. W., Watofrd, Ont.  
 Lussier, Jos., St. Pie, Que.  
 McArthur, L. C., Dewittville, Que.  
 McBroom Bros., Washburn, Ont.  
 McClymont, William, Ottawa, Ont.  
 McCormack Bros., Arthur, Ont.  
 McCullough, R., Hawkesville, Ont.  
 McDonald, James, Hopewell, N.S.  
 McDonald Bros., Mabou, N.S.  
 McDonald & Brown, Carleton Place,  
 [Ont.]  
 McDougall, Peter, Blakeney, Ont.  
 McKay, J., Kirkfield, Ont.  
 McKay & Co., Orillia, Ont.  
 McKay, M. S., & Co., Galt, Ont.  
 McKay Woolen Co., Charlottetown,  
 [P.E.I.]  
 McLean, J. A., Pembroke, Ont.  
 McLennan, Wm., Willow Grove, N.B.  
 McMurchy, John, Huttonville, Ont.  
 McNally, Clemens & Co., Blair, Ont.  
 McNaughton, C., Maxville, Ont.  
 McNeil, N. H. & N., Mira River, N.S.  
 McNeil & Morrison, Sydney, N.S.  
 Malcolm, Brantford, Ont.  
 Marchand, T., St. Jean des Chailions,  
 Martin, S. C., Preston, Ont. [Que.]  
 Matheson, Jas. Waugh's River, N.S.  
 Merizzie, A., Napierville, Que.  
 Messenger, Jacob, Hanover, Ont.  
 Methot, J. V., St. Antoine de Tilly, Q.  
 Mitchell, D., Marmora, Ont.  
 Milne, A. W., & Sons, Wexford, Ont.  
 Montreal Woolen Mills Co., Montreal,  
 [Que.]  
 Moore, John A., Moore's Mills, N.B.

Moorehouse, Dodds & Co., Glen Tay,  
 [Ont.]  
 Morrill, A. J., Nicolet Falls, Que.  
 Morrison, J. B., Hawkesbury, Ont.  
 Morrison, W., Lambeth, Ont.  
 Morrison Bros., Brownsburgh, Que.  
 Muir, R., & Co., Exeter, Ont.  
 Mullock, Jos., Bridgewater, N.S.  
 Myers, S., & Sons, St. Mary's, Ont.  
 Neehn & Herman, Flesherton, Ont.  
 Nubu, J., Lamlash, Ont.  
 Orr, W. E., Port Elmsley, Ont.  
 Ouellet, Samuel, St. Gervais, Que.  
 Oxford Mfg. Co., Oxford, N.S.  
 Page, M., St. Urbain, Que.  
 Paris Wincey Mills Co., Paris, Ont.  
 Parkinson, R., Kemptville, Ont.  
 [N.B.]  
 Paton Mfg. Co., Paris, Ont.  
 Perry, W. H., Napanee, Ont.  
 Peterson, E., Dundalk, Ont.  
 Piche, Hector, St. Baxile, Que.  
 Pike River Mills, St. Hyacinthe, Que.  
 Pitts Bros., St. Johns, Ont.  
 Poirier, J. N., Rochelle, Que.  
 Poirier, Nap., Ste. Anne de Stukley,  
 [Que.]  
 Pollard, A., Burgessville, Ont.  
 Pollock, W. C., Almonte, Ont.  
 Port Elgin Woolen Mills, Port Elgin,  
 [N.B.]  
 Purvis, P., Blyth, Ont.  
 Randle, J., Meaford, Ont.  
 Rapid City Woolen Mills, Rapid City,  
 [Man.]  
 Reid, J., Combermere, Ont.  
 Reid, S., Ferguslea, Ont.  
 Reiner, J. G., Wellesley, Ont.  
 Renaud, F., St. Hilaire, Que.  
 Richard, J. B. T., L'Epiphanie, Que.  
 Rife & Campbell, Walkerton, Ont.  
 Ritchie, James T., Beaverton, Ont.  
 Ritchie, Jas., & Sons, River John, N.S.  
 Ritchie, W., Sons, Markdale, Ont.  
 Robertson, H. W., St. Andrews East,  
 Rogers & Co., Alliston, Ont. [Que.]  
 Rosemond Woolen Co., Almonte, Ont.  
 Ross, J. Wesley, North East Mar-  
 [garee, N.S.]  
 Roy, J., St. Aime, Que.  
 Ryan, M., & Co., St. Boniface, Man.  
 St. Croix Woolen Mfg. Co., St. Croix,  
 [N.S.]  
 Schiedel, J. M., Breslau, Ont.  
 Scott, John, Clifford, Ont.  
 Seigman, G., Meustadt, Ont.  
 Sharp & Hunt, Bloomfield, Ont.  
 Shingsley, J., Dunneville, Ont.  
 Sibley, E. T., Wittenburg, N.S.  
 Simard, Alfred, Roberval, Que.  
 Simpson, R., South Finch, Ont.  
 Slingsby Mfg. Co., Brantford, Ont.  
 Skene, Jas., Prince William, N.B.  
 Smith Bros., Belmont, Ont.  
 Snow & Carr, Annapolis, N.S.  
 Stackhouse, C. F., Peveril, Que.  
 Standard Woolen Mills Co., Toronto,  
 Stanfield, C. E., Truro, N.S. [Ont.]  
 Stephenson, J., Orangeville, Ont.

## GENERAL LIST OF CANADIAN MANUFACTURERS.

Stephenson, Johnson & Co., St. Boni-  
[face, Man.  
Sutton, E., Lemonville, Ont.  
Sykes & Ainley Woolen Mfg. Co., Ltd.  
[Glen Williams, Ont.  
Syres, A. J., Wyoming, Ont.  
Taylor, D., Fergus, Ont.  
Taylor, D., Hampton, Ont.  
Tanner, George, Mount Forest, Ont.  
Taylor, T. H., Chatham, Ont.  
Terry, L. W. R., Colborne, Ont.  
Teskey, J. Adam, Appleton, Ont.  
Tetu, Thos., St. Giles, Que.  
Thorburn, Wm., Almonte, Ont.  
Tomb, D., Alexandria, Ont.  
Tomb, Jas., Alexandria, Ont.  
Trotier, I., Grondines, Que.  
Turcotte, H., West Broughton, Que.  
Turgon, Jos., St. Isidore, Que.  
Trenholm & Armitage Woolen Mfg.  
[Co., Coaticooke, Que.  
Trent Valley Woolen Mfg. Co.,  
Campbellford, Ont.  
Ure, J. A., Maberly, Ont.  
Valley Woolen Mills Co., Southamp-  
[ton, N.S.  
Van Egmond's, A. G., & Sons, Sea-  
forth, Ont.  
Vause, R. C., Glencoe, Ont.  
Vezina, Chas., Valcourt, Que.  
Walker, R., & Sons, Lyn, Ont.  
Walshaw, J., Bolton, Ont.  
Walsh, W. H., Fenelon Falls, Ont.  
Waltho, E., Dunnville, Ont.  
Ward, Benjamin, Alton, Ont.  
Ward, F. M. & W., Lucan, Ont.  
Warner, E., & Son, Alvington, Ont.  
Watchorn & Co., Merrickville, Ont.  
Waterhouse, Thos., Palmerston, Ont.  
Waterloo Woolen Co., Waterloo, O.  
Watts, W. J., Drummondville, Que.  
Wallace, Jas., Wyebridge, Ont.  
Webb, Chas, Smith's Falls, Que.  
Weber, D., Freeport, Ont.  
Weber, L., Nottawa, Ont.  
Webster, Geo., Cold Brook, N.S.  
Whiteside, R. F., Little Britain, Ont.  
Willett, S. T., Chambly Canton, Que.  
Wills, Alex., Golden Grove Mills, N.B.  
Wilson, L. J., & Co., Dutton, Ont.  
Wilson, Patullo & Co., Creemore, Ont.  
Winger, H. & J. B., Elmira, Ont.  
Woodstock Woolen Mills Co., Ltd.,  
[Woodstock, Ont.  
Wurtele, Chas. J. C., St. David, Que.  
Wyllie, J. H., Almonte, Ont.  
Yarmouth Woolen Mills Co.,  
[Yarmouth, N.S.

### BREWERS & DISTILLERS,

(See also Ale and Whiskey in classified list).

Allan & McKenzie, Moosejaw, N.W.T  
Anderson, Arthur, Ottawa, Ont.  
Anderton, James, (Est. of) Barrie, O.  
Andrzejewski, John, New West-  
[minster, B.C.  
Atkin, John, Montreal, Que.  
Bajus Brewery, Kingston, Ont.  
Bell, James, Portage la Prairie, Man.

Bernhardt, Louis, Woodstock, Ont.  
Bernhardt, P., Preston, Ont.  
Bixel Brewing & Malting Co., Brant-  
[ford, Ont.  
Blake Bros., Goderich, Ont.  
Boswell & Co., Quebec, Que.  
Bowie & Co., Brockville, Ont.  
Bow River Brewery, Calgary, N.S.  
Brading, H. F., & Co., Ottawa, Ont.  
Brain Bros., Hornby, Ont.  
British American Brewing Co.,  
[Windsor, Ont.  
Cairns, Thomas, Portage la Prairie,  
[Man.  
Calcut, Henry, Peterborough, Ont.  
Calgary Brewing & Malting Co.,  
[Calgary, N.W.T.  
Canadian Brewing Co., (The)  
[Montreal, Que.  
Carling Brewing & Malting Co., (The)  
[London, Ont.  
Carter, J. W., Victoria, B.C.  
Colbert, Henry, Egmondville, Ont.  
Copland Brewing Co., Toronto, Ont.  
Corby, H., Belleville, Ont.  
Cornell, Frederick, Toronto, Ont.  
Cosgrave Brewery Co., Ltd., (The)  
[Toronto, Ont.  
Cote & Amyot, Quebec, Que.  
Cronmiller & White, Port Colborne,  
[Ont.  
Dawes & Co., Lachine, Que.  
Davies Brewing & Malting Co., (The)  
[Toronto, Ont.  
Davies, C. L., Minnedosa, Man.  
Dewitt, Jacob, Vancouver, B.C.  
Doering & Marstrand Brewing Co.,  
[Vancouver, B.C.  
Dominion Brewery Co., (The)  
[Toronto, Ont.  
Dow William, & Co., Montreal, Que.  
Drewry, E. L., Winnipeg, Man.  
Eaton Bros. Brewery Co., Ltd., Owen  
[Sound, Ont.  
Ekers, H. A., Montreal, Que.  
Farquharson & Grainger, Walker-  
[ville, Ont.  
Findall, J. F., Trenton, Ont.  
Fisher Bros., Portsmouth, Ont.  
Gehl & Crysler, Port Arthur, Ont.  
Graham & Co., Orillia, Ont.  
Grant-Lottridge Brewing Co., Ltd.,  
[Hamilton, Ont.  
Goderich Brewing Co., Goderich, Ont.  
Gompf, John, Hamilton, Ont.  
Gooderham & Worts, Ltd., Toronto,  
[Ont.  
Halliday, Thomas, Guelph, Ont.  
Hamilton Distillery Co., Ham'ltan, O.  
Hamilton, Joseph, London, Ont.  
Haslam, W. H., Lindsay, Ont.  
Hayward, C. W., & Co., Halifax, N.S.  
Hergott Bros., Stratford, Ont.  
Heuser, Peter, Sarnia, Ont.  
Huether, C. N., & Co., Waterloo, Ont.  
Hummell, D., Preston, Ont.  
Jones, Simeon, St. John, N.B.  
Kantz, Jacob, Auburn, Ont.  
Keith, Alex., & Son, Halifax, N.S.  
Kormann, M. E., Toronto, Ont.  
Knight & Flinn, Regina, N.W.T.

Kuntz, Henry, Hamilton, Ont.  
Kuntz, Louis, (Est. of) Waterloo, Ont.  
Labatt, John, London, Ont.  
Lefebvre, M.che., & Co., Berthierville,  
[Que.  
Lindberg, John, Halifax, N.S.  
Luke, Joseph, & Sons, Tilsonburg, O.  
Maritime Brewing & Malting Co.,  
[Ltd., Halifax, N.S.  
McCarthy & Son C., Ltd., (The)  
[Prescott, Ont.  
McCroy, John, Montreal, Que.  
McLaren, J. A., Perth, Ont.  
Messner, F. T., Formosa, Ont.  
Molson, J. H. R., & Bro., Montreal,  
[Que.  
Montreal Brewing Co., (The)  
[Montreal, Que.  
Murphy, John, Rossland, B.C.  
Newmeyer, Joseph, Brandon, Man.  
Nova Scotia Brewery, Halifax, N.S.  
Odell, C. J. & F. W., Sherbrooke, Que.  
O'Keefe Brewery Co., Toronto, Ont.  
Ontario Brewing & Malting Co., Ltd.,  
[Toronto, Ont.  
Orillia Brewing Co., Orillia, Ont.  
Orland, S., Sons & Co., Halifax, N.S.  
Ottawa Brewing & Malting Co.  
Otterbein, C., Salem, Ont.  
Prescott Brewing & Malting Co.,  
[Prescott, Ont.  
Ready, James, Fairville, N.B.  
Rau, M., New Hamburg, Ont.  
Reinhardt & Co., Toronto, Ont.  
Reinhardt, G., & Sons, Montreal, Q.  
Reuter, Geo., Salem, Ont.  
Rock Spring Brewery, Quebec, Que.  
Roth, Robert, Listowel, Ont.  
Roy, James, A., Belleville, Ont.  
Rudolph & Begg, St. Thomas, Ont.  
Schwan, David, Carlsruhe, Ont.  
Schwartz, John, Formosa, Ont.  
Seagram, J. E., Waterloo, Ont.  
Sheard, Henry & Co., Stratford, Ont.  
Simpson, T. W., Barrie, Ont.  
Sleeman, George, Guelph, Ont.  
South Edmonton Lager Brewing Co.,  
[Edmonton South, N.W.T.  
Spalding & Stewart, Perth, Ont.  
Star Brewing Co., (The) Montreal, Q.  
Taylor & Bate, St. Catharines, Ont.  
Toronto Brewing & Malting Co.,  
[Toronto, Ont.  
Union Brewing Co., Ltd., Nanaimo,  
[B.C.  
Walker, Hiram, & Sons, Ltd.,  
[Walkerville, Ont.  
Walkerville Brewing Co., Ltd.,  
[Walkerville, Ont.  
Watson, E. J., Listowel, Ont.  
Winslow, Ambrose, Brewing Co.,  
[Port Hope, Ont.  
Wisner, J. P., & Son, Prescott, Ont.

### MANUFACTURERS.—Carriage.

(See also Wagons in classified list).

Alexandria Carriage Works,  
[Alexandria, Ont.  
Armstrong (The J.B.) Mfg. Co., Ltd.,  
[Guelph, Ont.

## GENERAL LIST OF CANADIAN MANUFACTURERS.

- Ashley Carriage Co., Belleville, Ont.  
Auld & Armstrong, Hamilton, Ont.  
Berard & Major, Montreal, Que.  
Bolduc, Louis, Montreal, Que.  
Borland, E., Tilsonburg, Ont.  
Brantford Carriage Wheel Factory,  
[Brantford, Ont.  
Brockville Carriage Co., Brockville, O.  
Brownell & Kennedy, St. Thomas, O.  
Campbell, John, London, Ont.  
Canadian Cone Coupler Carriage Co.,  
[Palmerston, Ont.  
Canniff, H., Belleville, Ont.  
Chisholm, Roderick, Antigonishe, N.S.  
Cooper, Frank L., Fredericton, N.B.  
Crothers, Henderson & Wilson,  
[St. John, N.B.  
Cusson, Felix, Montreal, Que.  
Darch, J. A., & Co., Toronto, Ont.  
DeWolf, Son & Co., Halifax, N.S.  
Dixon, John, Toronto, Ont.  
Dowsley, T. B., Owen Sound, Ont.  
Duhamel, L., Ottawa, Ont.  
Edgecombe Bros., Fredericton, N.B.  
Gray, Wm., & Sons, Chatham, Ont.  
Graybill Bro., Berlin, Ont.  
Guy, Matthew, Toronto, Ont.  
Hamilton, James, Lindsay, Ont.  
Henev, E. N., & Co., Montreal, Que.  
Hewson Bros., Chatham, Ont.  
Hicks, J. G., Moncton, N.B.  
Hutchinson & Son, Toronto, Ont.  
Kelly & Murphy, St. John, N.B.  
Kingston Vehicle Co., Ltd., Kingston,  
[Ont.  
Lamphier, Andrew, Halifax, N.S.  
Lariviere, N. & A. C., Montreal, Que.  
McCullouch, G. W., Ottawa, Ont.  
McLaughlin Carriage Co., Oshawa, O.  
McLean, Angus, Newcastle, N.B.  
Miner Carriage Mfg. Co., Granby, Q.  
Moran, J. H., London, Ont.  
Nash, B. J., & Co., London, Ont.  
Ouimet, Alexis, Montreal, Que.  
Patterson, J. D., & Co. Hamilton, O.  
Price & Shaw, St. John, N.B.  
Ramsay, William, Orillia, Ont.  
Ray Bros., Yarmouth, N.S.  
Reddy, Thomas, Halifax, N.S.  
Robinson Carriage Mfg. Co., Ltd., The  
[Coldwater, Ont.  
Sherman, N. G., & Co., Iroquois, Ont.  
Simpson, I. Mfg. Co., (The) Brantford,  
[Ont.  
Smith, Alex., London, Ont.  
Smith Bros., Toronto, Ont.  
Spence, A., & Son, Brantford, Ont.  
Sproule, G. H., Vancouver, B.C.  
Tudhope Carriage Co., Orillia, Ont.  
Thompson, W. J., London, Ont.  
Thousand Islands Carriage Co., Ltd.,  
[(The) Gananoque, Ont.  
Vandyke, John, Grimsby, Ont.  
Webster, W. R., & Co., Sherbrooke,  
White & Co., Galt, Ont. [Que.]
- MANUFACTURERS.—Cigar.**  
Anderson, F., Niagara Falls, Ont.  
Andrew, T. J., Hamilton, Ont.  
Archambault & Racette, St. Alexis  
[de Montcalm, Que.
- Bantley, Marcus, Victoria, B.C.  
Beaulieu, J. B., & Co., Quebec, Que.  
Begy Bros., St. Catharines, Ont.  
Bell Cigar Co., (The) Ltd., St. John,  
[N.B.  
Bernard & Lefebvre, Montreal, Que.  
Elumenstiel, J., Hamilton, Ont.  
Bolduc Freres, Joliette, Que.  
Borthwick, Geo. A., & Co.,  
[Kamloops, B.C.  
Brown Bros., Montreal, Que.  
Cauley, B., Hamilton, Ont.  
Central Cigar Co., Preston, Ont.  
Chaput & Co., Montreal, Que.  
Clough, James J., Montreal, Que.  
Cohen, M., Victoria, B.C.  
Creme de la Creme Cigar Co.,  
[Montreal, Que.  
Danis, Eugene, St. Jerome, Que.  
Davis, David, Montreal, Que.  
Davis, Samuel & Son, Montreal, Que.  
Davis, Z., & Co., Montreal, Que.  
Dobson, W. E., Toronto, Ont.  
Eichhorn & Carpenter, Toronto, O.  
Empire Tobacco Co., Montreal, Que.  
Fair, T. J., & Co., Brantford, Ont.  
Fletcher Bros., Toronto, Ont.  
Flynn Bros., Hamilton, Ont.  
Forest, Simeon, Montreal, Que.  
Fortier, J. M., Montreal, Que.  
Fraser, McWilliam & Co., London, O.  
Gable, P., & Co., Nanaimo, B.C.  
Gardner, H. B., Brantford, Ont.  
Garroch, P., Listowel, Ont.  
Girardin, J., Brockville, Ont.  
Globe Cigar Co., Levis, Que.  
Globe Tobacco Works, London, Ont.  
Goderich Cigar Co., (The) Goderich,  
[Ont.  
Goldstein, B., & Co., Montreal, Que.  
Goldstein, M., Ottawa, Ont.  
Goulet Bros., Montreal, Que.  
Grothe, L. O., & Co., Montreal, Que.  
Halifax Cigar Co., Halifax, N.S.  
Hamlin, R. W., St. Catharines, Ont.  
Harris, I., & Son, Montreal, Que.  
Harris, J. C., St. Catharines, Ont.  
Hart, Isaac, Montreal, Que.  
Havana Cigar Co., (The) Montreal,  
[Que.  
Hickey & Nicholson, Charlottetown,  
[P.E.I.  
Hill, J., Hamilton, Ont.  
Hirsch, J., Sons & Co., Montreal, Q.  
Holloran, M. K., Brantford, Ont.  
Honsinger, B. F., St. Thomas, Ont.  
Houde, B., & Co., Quebec, Que.  
Isaacs, Abraham, St. John, N.B.  
Jacobs, H., & Co., Montreal, Que.  
Joliette & St. Jacques, Joliette, Que.  
Karston Bros., Hamilton, Ont.  
Kelly, G., London, Ont.  
Kelly, J. F., Hamilton, Ont.  
Kenna, A. M., Pictou, N.S.  
Klee, Antoinette, Toronto, Ont.  
Lafrance & Labelle, Montreal, Que.  
Langlois, L. P., & Cie, Three Rivers,  
[Que.  
Langton, F. W., Guelph, Int.
- Larue, T., & Co., Montreal, Que.  
Lefebvre, J. E., Montreal, Que.  
Lemesurier, J., & Sons, Quebec, Que.  
Line, McDonald & Co., London, Ont.  
Lovell Bros., Hamilton, Ont.  
Macfarlane, J. C., & Co., Montreal,  
[Que.  
McAlpin Tobacco Co., Toronto, Ont.  
McDonald, W. C., Montreal, Que.  
McGowan, G. A., Kingston, Ont.  
McHugh, John, St. Catharines, Ont.  
McKay, H., & Co., London, Ont.  
McKenna, Archibald, Pictou, N.S.  
Maddock & Co., Toronto, Ont.  
Maddocks, W., Guelph, Ont.  
Mailhot, E., & Frere, Three Rivers,  
[Que.  
Manners, S. R., London, Ont.  
Martin, Mederic, Montreal, Que.  
Meinke, William, Berlin, Ont.  
Milligan, Geo., Toronto, Ont.  
Moses, John, Galt, Ont.  
Murty, A., Peterboro', Ont.  
Myers & McCaffrey, Montreal, Que.  
Nova Scotia Cigar Manufacturing  
Co., Ltd., Halifax, N.S.  
Oberndorffer, S., Kingston, Ont.  
O'Brien, C., Barrie, Ont.  
O'Brien & Bro., Chatham, Ont.  
O'Kelly, J., Pembroke, Ont.  
Olmsted, G., & Co., London, Ont.  
Pae, J. B., Tobacco Co., (The)  
[Montreal, Que.  
Pagels, F., & Son, Montreal, Que.  
Poulin & Co., Brockville, Ont.  
Reid, A., Owen Sound, Ont.  
Ritchie, D., & Co., Montreal, Que.  
Roman, S., Montreal, Que.  
Riley, T. B., Charlottetown, P.E.I.  
Schaefer, Frank, Toronto, Ont.  
Schnoter, Andrew, Victoria, B.C.  
Schultz, D. L., Guelph, Ont.  
Schwartz, F., Hamilton, Ont.  
Sheenan, R., Hamilton, Ont.  
Siebert & O'Dowd, Hamilton, Ont.  
Sievert, Louis, Toronto, Ont.  
Simon, H., London, Ont.  
Smith, A., Ingersoll, Ont.  
Smith, A., & Co., London, Ont.  
Smith, Fischel & Co., Montreal, Que.  
Smith, Jos., London, Ont.  
Spilling Bros., Toronto, Ont.  
Stephan, F. W., Berlin, Ont.  
Swain, Henry, & Son, Montreal, Q.  
Tasse Wood & Co., Montreal, Que.  
Taylor, John, Toronto, Ont.  
Tuckett, Geo. E., & Sons, (The) Co.,  
[Ltd., Hamilton, Ont.  
Ward, William, London, Ont.  
Waxstock, H., & Son, Victoria, B.C.  
Whaley, N. O., Lemington, Ont.  
White, John, Hamilton, Ont.  
Winter, D. L., (Estate of) Paris, Ont.  
Winterhalt, Jos., Berlin, Ont.  
Wood Bros., Brockville, Ont.  
Woods, B. K., Brockville, Ont.  
Wurtele, E. C., Sorel, Que.



H. D. WARREN, PRES. AND TREAS.

C. N. CANDEE, SECV.

# THE GUTTA PERCHA & RUBBER MFG. CO.

FACTORIES: PARKDALE, TORONTO.

CAPITAL, - - - \$200,000.00,

OF TORONTO, LIMITED.



“MALTESE CROSS”

BRAND

MACKINTOSHES

“MALTESE CROSS,”

“BAKER FABRIC”

AND

“AJAX”

BRANDS

FIRE HOSE.

Mackintosh and  
Correspondence

kind for  
cal Purposes.  
Valves, Steam Hose,  
WEST,  
TORONTO, Canada.



FRE

& CO.

Detroit, Mich., U.S.

New York City.

TORONTO PUBLIC LIBRARIES

We offer full  
as well as many of  
Medicinal Syru  
Medicinal Tinct  
Concentrated L  
Ointments, Cer

REFERENCE LIBRARY

of our own manufacture

Oleates,  
Assayed Fluid  
Tinted Granules,

Tablets and Pills,  
Hypodermic Tablets,  
Dosimetric Granules.

Sugar Coated Pills,  
Gelatine Coated Pills,  
Dose-metric Granules.

**CASCARA SAGRADA**, in form of Fluid  
and Solid Extract, Elixir, Pills, Granules, Capsules,  
etc.

**KOLA**, in form of Fluid Extract of the dried and  
also of the Fresh, (undried) nut, Solid Extract Cor-  
dial, Wine, Lozenges, Pills, etc.

### ORIGINAL SPECIALTIES.

**Stearns' Cascara Aromatic,**

The Original—Introduced in 1889.

**Stearns' Wine of Cod Liver Oil,**

With Peptonized Iron—Introduced in 1892.

**Haemoferrum,**

Blood Iron—Introduced in 1893.

**Kola Cordial (Stearns'),**

The Original—Introduced in 1893.

**Kolavin,**

A Powerful Cerebro-Spinal Stimulant—Introduced  
in 1894.

**Kolabon,**

Introduced in 1894.

670.2116