

THE
ANATOMY,
PHYSIOLOGY AND PATHOLOGY
OF THE
EYE.

~~~~~  
BY HENRY HOWARD, M. R. C. S. L.,  
SURGEON TO THE MONTREAL EYE AND EAR INSTITUTION.  
~~~~~

Montreal:
ARMOUR & RAMSAY.

London:
JOHN CHURCHILL.

—
1850.

P R E F A C E .

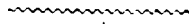

THE organization of the EYE, and its beautiful adaptation to the wants and necessities "of every living thing," has always been a subject sufficiently attractive to secure attention and respect from the most thoughtless and indifferent; from those even, who in other respects, are disposed to forget the wonderful nature of their creation, the fearful construction of every organ and sense with which they are endowed.

On an inquiry which possesses so many attractions to the general Student, some feelings of diffidence might be fairly expressed by a writer, when committing his thoughts to the criticism of the public; but the fears of the author rise into anxiety, when he invites the attention of the Faculty to a work, which not only treats generally, of the Organ of Vision, but professes to inquire critically, into its Anatomy, Physiology, and Pathology.

The Author may, however, be allowed to say, that while he has not been insensible to the magni-

tude of the undertaking in which he has engaged, nor regarded with unconcern, the difficulties with which its prosecution would be attended, he has been encouraged to perseverance, not only by the remembrance, that a great part of his early studies was directed, under the guidance of one of the most learned and successful of European Practitioners,* to the investigation of this particular portion of Medical and Surgical Science, but that he has for the last four years, as the Surgeon to "The Montreal Eye and Ear Institution," devoted his labours exclusively to the treatment of diseases incident to these organs.

The Author has been desirous, by simplicity of arrangement, to facilitate the means of reference, and thus make his work acceptable to the Profession generally; nor is he without hope that, in the classification which has been adopted in reference to particular diseases, it will be found a useful compendium to those who may wish to consult it in the course of their practice.

He has availed himself of the published opinions of the numerous distinguished writers who have explored the field of Science in which he has laboured; and he wishes in this place to state, not only his great obligations to them for the information

* Dr. Jacob, of Dublin.

which he has been enabled to derive from their writings, but also to express to those learned and respected friends who have contributed many valuable notes and suggestions, his sense of the service they have rendered to his inquiry; a service by which, in some instances, he has been enabled not only to enrich his work, but to confirm his own experience of the propriety of the treatment which he has successfully pursued; a treatment, which the author may be pardoned for stating, has not been suggested in any published treatise on the Pathology of the EYE which has come under his notice.

In conclusion, he begs to state, that, in deference to the views of several friends, he has so far deviated from the plan indicated in his Prospectus, as to dispense with the proposed Appendix to his work, and to include the matter of which it was to have been composed, in the body of the volume.

TABLE OF CONTENTS.

CHAPTER I.		PAGE	
	PAGE		
ANATOMY OF THE ORBIT,.....	1	Orbital Plexus of Nerves,.....	14
Bones forming the Orbit,.....	1	Third Pair of Nerves,.....	14
Foramina in the Base of the Orbit,	2	Trochlear or Fourth Nerve,....	15
Foramina within the Orbit,.....	3	Trigemini or Fifth Nerve,.....	15
Contents of the Orbit,.....	3	The Ophthalmic Nerve,.....	15
Lachrymal Gland,.....	3	Lachrymal Branch of the Fifth,.	15
Levator Palpebræ Superioris,...	4	Frontal Nerve,.....	16
Recti Muscles,.....	4	Supra Trochlear Nerve,.....	16
Superior Oblique Muscle,.....	5	Supra Orbital Nerve,.....	16
Inferior Oblique Muscle,.....	6	Nasal Nerve,.....	17
ANATOMY OF THE PALPEBRÆ,.....		Infra Trochlear Nerve,.....	17
Orbicularis Palpebrarum Muscle,	6	Nasal Nerve Proper,.....	17
Tendo Oculi Muscle,.....	7	Sixth or Abducens Nerve,.....	17
Tensor Tarsi Muscle,.....	7	Infra Orbital Nerve,.....	18
Corrugator Supercilii,.....	8	Lenticular Ganglion,.....	18
Tarsal Cartilages,.....	8	Ciliary Nerves,.....	19
Meibomian Glands,.....	8	ANATOMY OF THE GLOBE OF THE EYE	
Cilia,.....	8	Tunica Sclerotica,.....	20
Membrana Conjunctiva,.....	8	Cornea,.....	21
Caruncula Lachrymalis,.....	9	Choroid Coat,.....	22
Puncta Lachrymalia,.....	9	Ciliary Ligament,.....	23
Lachrymal Ducts,.....	9	Ciliary Muscle,.....	23
Lachrymal Sac,.....	9	Ciliary Processes,.....	24
Nasal Duct,.....	10	Iris,.....	25
Nasal Canal,.....	10	Retina,.....	26
		Aqueous Humour,.....	27
		Crystalline Humour,.....	28
		Vitreous Humour,.....	29
CHAPTER II.		CHAPTER III.	
THE ANATOMY OF THE VESSELS AND NERVES OF THE ORBIT, AND THE ANATOMY OF THE GLOBE OF THE EYE.		PHYSIOLOGY OF THE ORBIT AND ITS CONTENTS, WITH THE EXCEPTION OF THE GLOBE OF THE EYE.	
Arteries of the Orbit,.....	11	Orbit,.....	30
Ophthalmic Artery,.....	11	Periosteum,.....	30
Arteria Centralis Retinæ,.....	11	Fat of the Orbit,.....	31
Lachrymal Arteries,.....	11	Tunica Vaginalis Oculi,.....	31
Superior Orbital Artery,.....	12	Vessels of the Eye,.....	31
Posterior Ciliary Arteries,.....	12	Conditions of the Eye,.....	31
Long Ciliary Arteries,.....	12	Recti Muscles,.....	33
Supra and InfraMuscularArteries,	12	Superior and Inferior Oblique Muscle,.....	35
Æthmoidal Artery,.....	12	Levator Palpebræ Muscle,.....	40
Superior and Inferior Palpebral Arteries,.....	13	Orbicularis Palpebrarum,.....	40
Nasal Artery,.....	13	Tensor Tarsi,.....	41
Frontal Artery,.....	13		
Optic Nerve,.....	13		

	PAGE		PAGE
NERVES OF THE EYE, PALPEBRÆ, AND ORBIT,.....	42	Incised and Punctured Wounds of the Edge of the Orbit,....	81
Sympathetic Nerve,.....	43	Gun-shot Wounds of the Edge of the Orbit,.....	82
Optic Nerve,.....	44	CHAPTER VI.	
Motores Oculorum, or Third Pair,	44	Fractures and Injuries of the Walls of the Orbit,.....	85
Trochleator or Fourth Nerve,....	45	CHAPTER VII.	
Fifth Pair of Nerves,.....	45	Diseases of the Orbit, Periostitis, Caries, and Necrosis,.....	87
Iris,.....	50	CHAPTER VIII.	
Sixth or Abducens Nerve,.....	51	Periostosis,.....	92
Lachrymal Organs,.....	52	Hyperostosis,.....	94
Conjunctiva,.....	52	Exostosis,.....	95
Meibomian Glands,.....	52	Osteo-Sarcoma,.....	98
Cilia,.....	52	CHAPTER IX.	
Eye-brows,.....	52	DEFORMITY OF THE ORBIT FROM EXTER- NAL PRESSURE.	
CHAPTER IV.		Tumours of the Nose,.....	100
OPTICS, AND PHYSIOLOGY OF THE EYE		Maxillary Sinus,.....	101
Light,.....	53	Frontal Sinus,.....	105
Dioptrics,.....	57	Sphenoidal Sinus.....	107
Double Convex Lens,.....	60, 61	Cranium,.....	107
Double Concave Lens,.....	62	CHAPTER X.	
Sunlight,.....	62	Tumours in the Orbit,.....	108
Chromatics,.....	63	CHAPTER XI.	
Optics Relating to the Eye,....	64	DISEASES OF THE ORBITAL CELLULAR, MEMBRANE, AND TUNICA VAGINALIS OULLI.	
Cornea, a Transparent Medium,...	65	Inflammation of the Orbital Cel- lular Membrane,.....	113
Aqueous Humour,.....	65	Scirrhus of the Orbital Cellular Membrane,.....	117
Iris,.....	65	Tunica Vaginalis Oculi, Inflam- mation of,.....	117
Myopia,.....	66	CHAPTER XII.	
Presbyopia,.....	69	DISEASES OF THE SECRETING LACH- RYMAL ORGANS,.....	122
Ciliary Muscle,.....	71	Xerophthalmia,.....	123
Tunica Sclerotica,.....	74	Epiphora,.....	124
Choroid Coat,.....	74		
Ciliary Processes,.....	74		
Retina,.....	75		
Cornea,.....	76		
Aqueous Humour and its Tunic,...	76		
Iris,.....	77		
Capsule of the Lens,.....	78		
Lens,.....	78		
Vitreous Humour,.....	78		
Hyaloid Membrane,.....	78		
PART II.			
—			
PATHOLOGY.			
—			
CHAPTER V.			
Contusions of the Edge of the Orbit,.....	79		
Fractures of the Edge of the Orbit.	80		
Compound Fractures of the Edge of the Orbit,.....	81		

PAGE	PAGE		
Inflammation of the Lachrymal Gland,.....	125	Incised and Lacerated Wounds of, 171	
Chronic Enlargement of the Lachrymal Gland,.....	128	Phlegmonous Inflammation of, 173	
Encysted Tumours in the Lachrymal Gland,.....	129	Erysipelatous Inflammation of, 174	
Encysted Tumours in the Vicinity of the Glandular Congregata and Lachrymal Ducts,.....	130	Carbuncle or Anthrax of,.....	176
True Lachrymal Fistula,.....	131	Syphilitic Ulceration of,.....	177
Morbid Tears,.....	131	Scirrhus or Cancer of,.....	178
Sanguineous Lachrymation,.....	132	Inflammation of the Edges of the Eye-lids,.....	180
Lachrymal Calculus,.....	133	Porrigo Larvalis of the edges of the Eye-lids,.....	183
Extirpation of the Lachrymal Gland,.....	133	Disease of the Meibomian Glands, 184	
CHAPTER XIII.		Hordeolum,.....	184
DISEASES OF THE EXCRETING LACHRYMAL ORGANS.		Phlyctenula of the Eye-lids,....	185
Acute Daeryocystitis,.....	135	Millium of the Eye-lids,.....	185
Chronic Daeryocystitis,.....	137	Warts of the Eye-lids,.....	185
Pistula Lachrymalis,.....	147	Tumours of the Eye-lid,.....	185
Mucocele of the Sac,.....	150	Tylosis, or Callosity of the Eye-lids,.....	187
Relaxation of the Sac,.....	151	Nævus Materius and Aneurism, by Anastomosis of,.....	187
Polypus of the Sac,.....	152	Edema of the Eye-lids,.....	191
Calculi in the Excreting Lachrymal Passages,.....	152	Emphysema of the Eye-lids,....	191
Obstruction of the Puncta,.....	152	Twitching of the Eye-lids,.....	195
Relaxation of the Puncta,.....	153	Morbid Nictitation,.....	196
Injuries of the Excreting Lachrymal Organs,.....	153	Blepharospasmus,.....	196
CHAPTER XIV.		Paralysis of the Orbicularis Palpebrarum,.....	198
INJURIES AND DISEASES OF THE MUSCLES OF THE EYE-BALL.		Pto-sis,.....	199
Paralysis of the Muscles,.....	155	Epicantus,.....	202
Strabismus or Squint,.....	156	Lacophthalmos,.....	202
Lusctas,.....	164	Ectropium,.....	204
Oscillation,.....	166	Trichiasis,.....	213
Nystagmus,.....	167	Entropion,.....	216
Diplopia,.....	167	Symblepharon,.....	221
Tetanus Oculi,.....	168	Anchyloblepharon,.....	222
CHAPTER XV.		Phthiriasis,.....	225
INJURIES AND DISEASES OF THE EYE-LIDS AND EYE-BROWS.		CHAPTER XVI.	
Contusions,.....	169	INJURIES, AND DISEASES OF THE CONJUNCTIVA, SEMILUNAR MEMBRANE AND CARUNCULA LACHRYMALIS.	
Poisoned Wounds of,.....	170	Foreign Bodies in the Conjunctiva,.....	224
Burns and Scalds of,.....	170	Subconjunctival Ecchymosis,....	227
		Emphysema, ..	227
		Phlegmon,	228
		Edema,.....	228
		Pterygium,.....	228
		Pinguecula,.....	230
		Warts of the Conjunctiva,.....	230
		Polypus of the Conjunctiva,....	231

	PAGE
Moles of the Conjunctiva,.....	231
Tumours of the Conjunctiva,....	231
Fungus of the Conjunctiva,.....	231
Encanthis,.....	232
Inflammation of the Semi-lunar Membrane and Caruncula,....	234

CHAPTER XVII.

INJURIES OF THE EYE-BALL.	
Injuries of the Cornea,.....	234
Penetrating Wounds of,.....	236
Foreign Bodies in the Aqueous Humour,.....	239
Injuries of the Iris,.....	241
Injuries of the Lens and Capsule,	241
Dislocation of the Lens,.....	242
Wounds of the Sclerotic and Cho- roidæa,.....	243
Blows on the Eye,.....	245

CHAPTER XVIII.

OPHTHALMIA,.....	246
General Causes of Inflammation of the Eye,.....	247
Catarrhal Ophthalmia,.....	248
Purulent Ophthalmia,.....	253
Gonorrhœal Ophthalmia,.....	272
Purulent Ophthalmia of Infant,	280
Phlyctenular or Scrofulous Oph- thalmia,.....	290
Pustular Ophthalmia,.....	304
Ophthalmia Variolosa,.....	306
Erysipelatous Ophthalmia,....	308
Corneitis or Keratitis,.....	309
Sclerottitis,.....	312
Choroiditis,.....	316
Retinitis Acute,.....	321
Retinitis Chronic,.....	327
Iritis,.....	329
Acute Iritis,.....	331
Chronic Iritis,.....	338
Syphilitic Iritis,.....	341
Aquo-Capsulitis,.....	347
Inflammation of the Lens and Capsule, (Cataract),.....	349
Inflammation of the Hyaloid Membrane (Glaucoma),.....	358
Ophthalmitis,.....	362
Compound Ophthalmia,.....	374

	PAGE
Traumatic Ophthalmia,.....	374
Artificial Ophthalmia,.....	374
Intermittent Ophthalmia,.....	374
Sympathetic Ophthalmia,.....	376

CHAPTER IX.

DISEASES OF THE EYE WHICH ARE THE
CONSEQUENCES OF INFLAMMATION.

Granular Conjunctiva,.....	377
Conjunctival Xeroma,.....	381
Abscess of the Cornea, <i>capæ</i> or <i>anguis</i> ,.....	382
Hypopium,.....	384
Ulcers of the Cornea,.....	385
Nebula of the Cornea,.....	389
Albugo of the Cornea,.....	392
Leucoma,.....	393
Synechia,.....	401
Obliteration of the Pupil,.....	401
Artificial Pupil,.....	402
Corotomia or Incision,.....	408
Corectomia or Excision,.....	410
Corodialysis or Separation,....	412
Cataract, Treatment of by Ope- ration,.....	414
Extraction,.....	434
Displacement,.....	444
Division through the Sclerotica, ..	447
Cornea,....	448
Staphyloma,.....	452
Spherical Staphyloma,.....	453
Conical Staphyloma,.....	456
Staphyloma Racemosum,.....	457
Sclerotic,....	457
Synchesis or Dissolution of the Vitreous Humour,.....	459
Atrophy of the Eye,.....	459
Varicosity of the Vessels of the Eye,.....	460
Amaurosis,.....	460
Neuralgia of the Fifth Nerve, ..	478
Ossific Deposits in Different Parts of the Eye,.....	480

CHAPTER XX.

Hydrophthalmia,.....	482
Conical Cornea,.....	485
Sanguineous Effusion into the Eye,.....	486

TABLE OF CONTENTS.

xi

PAGE	PAGE
Non-malignant Tumours of the	Myosis,..... 498
Eye-ball,..... 487	Mydriasis,..... 499
CHAPTER XXI.	
MALIGNANT AFFECTIONS OF THE EYE-	Tremulous Iris,..... 499
BALL, EXTIRPATION OF THE EYE,	Malformation of the Iris,..... 500
ADAPTATION OF AN ARTIFICIAL EYE.	Entozoa in the Organ of Vision, 501
Scirrhus of the Eye-ball,..... 489	Irregular Refraction,..... 502
Fungus Hæmatodes of the Eye-	Insensibility of the Eye to cer-
ball,..... 490	tain Colors,..... 502
Melanosis of the Eye-ball,..... 494	Crupsia or Colored Vision,..... 502
Extirpation of the Eye-ball,.... 494	Photop-ia or Shining Spectra, 502
Adaptation of an Artificial Eye, 496	Musca Volitantes,..... 503
CHAPTER XXII.	
VARIOUS STATES OF THE EYE INDE-	Nyctalopia or Night-blindness, 503
PENDANT OF INFLAMMATION.	Hemeralopia or Day-blindness, 504
Arcus Senilis,..... 498	Hemiopia,..... 504
	Amblyopia,..... 505
	Scotoma,..... 505

ERRATA.

Page 150, line 13 from top of page, for *Liquor Amon*, read *Liquor Ammon*.

Page 139, in prescription, for *axungia*, read *arungia*.

Page 187, line 28 from top of page, for *arthirtic*, read *arthritic*.

Page 232, line 29 from top of page, for *Funguos*, read *Fungus*.

Page 252, in prescription, for *aqua pur*, read *aqua pur*, and for *ft. lotion*, read *ft. lotio*.

Page 340, in prescription, for *quinine*, read *quina*.

Page 355, line 3 from top of page, for *hundreds*, read *numbers*.

Page 379, in prescription, for *quinine*, read *quina*.

Page 478, in prescription, for *Tart. ant. gr.*, read *Tart. ant gr. 1*.

CHAPTER I.

ANATOMY OF THE ORBIT.

THE orbits are situated in the upper part of the face, one at either side of the nose. They are cavities, of a pyramidal shape, the bases of which look forwards and outwards, and their apices backwards and inwards. Their axes are oblique lines, which if continued backwards, would decussate at the sella turcica of the sphenoid bone; while anteriorly these lines would diverge.

In the lower animals, the orbits are situated more laterally than they are in man; consequently the former have a wider range of vision than the latter, a power which is of the greatest importance to animals of a timid nature, as it the better enables them to see approaching danger.

BONES FORMING THE ORBIT.

Seven bones enter into the formation of the orbit; viz: the frontal, sphenoid, æthmoid, lachrymal, maxillary, palate, and malar bones. The base is formed *superiorly* by the frontal bone, *externally* by the external orbital angle of the frontal, and by the ascending ramus of the orbital process of the malar, *inferiorly* by the transverse ramus of the orbital process of the malar bone, and the anterior edge of the orbital process of the superior maxillary bone. The *internal* part of the base is formed by the external side of the nasal process of the frontal and superior maxillary bones.

There are *four* foramina in the base of the orbit, viz: the supra and infra orbital foramina, and the malar, and nasal ducts.

The roof of the orbit is formed *anteriorly* by the orbital process of the frontal and *posteriorly* by the lesser wing of the sphenoid bone. The roof is concave, and in its posterior part (which is the axis of the orbit) is situated the optic foramen.

In the *anterior*, and *external* angle of the roof, there is a depression for the lachrymal gland. *Anteriorly* and *internally* there is another for the trochleator muscle.

The floor of the orbit is nearly a plane, and is formed by the malar, maxillary, and palatine bones. The infra orbital canal extends along the floor.

The external wall of the orbit is formed by the orbital process of the malar bone, and orbital surface of the *great* wing of the sphenoid bone. Its surface looks forwards and inwards towards the median line. The internal wall is formed by the lachrymal bone and os planum of the æthmoid. In this wall are the two internal orbital holes, which are situated close to the suture that unites the os planum to the os frontis. There are five foramina within the orbit, viz: the *optic*, which is in the upper, inner, and posterior part, the *foramen lacerum superius*, which is situated between the greater and lesser wings of the sphenoid bones; the *third* and *fourth* are the two internal orbital foramina near the suture on the inner wall; and the *fifth* the foramen lacerum inferius, which leads from the back of the orbit forwards, and outwards along the floor; this last foramen is a slit like opening of a triangular shape, its base being external and anterior; it is bounded by the malar, maxillary, sphenoid, and palatine bones.

Through the foramen opticum passes the optic nerve with its neurilemma, and the central artery of the retina. The foramen lacerum superius transmits the third, fourth, and sixth cerebral nerves with the first branch of the fifth.

The two internal orbital holes give passage to the anterior, and posterior æthmoidal arteries; the nasal nerve also passes

through the anterior hole. Through the supra-orbital hole passes the supra-orbital nerve and artery; this artery is a branch of the ophthalmic; and the nerve a branch of the ophthalmic branch of the fifth nerve.

Through the infra-orbital foramen passes the infra-orbital artery, and nerve; this artery is a branch of the internal maxillary; the nerve is the terminating branch of the superior maxillary nerve.

Through the speno-maxillary fissure, or foramen lacerum inferius, passes the infra-orbital artery, and the infra-orbital branch of the superior maxillary nerve, previously to that nerve entering the canal.

The malar duct sometimes transmits small vessels and nerves into the orbit. The nasal canal contains the nasal duct, and branches of the fifth nerve, that terminate in the mucous membrane of that duct.

CONTENTS OF THE ORBIT.

There is contained within the orbit, the eye, with its six proper motor muscles, and an additional muscle called the levator palpebræ superioris. It includes also vessels, nerves, cellular tissue, and fat, together with the *lachrymal gland* and lenticular ganglion.

The best way to get at these parts, as nearly as possible in situ, is by removing the roof of orbit.

Lachrymal Gland.—The lachrymal gland is situated in the fossa which carries its name; it lies superior to the globe of the eye, and behind the conjunctiva; its size is about that of a small bean, colour pale, and shape oval. It is separable into two lobes, which can be again separated into numerous granules united by a loose capsule.

From these granules proceed five or six small ducts, which open behind the upper eye-lid, along the line of reflection of the conjunctiva from the palpebra superior to the tunica sclerotica.

Through *these* ducts are carried the tears secreted by the gland.

Levatoræ Palpebræ Superioris.—The next part of the contents of the orbit that comes to be examined, is the levator palpebræ superioris, a long muscle running along the roof of the orbit, arising narrow, and tendinous from the upper edge of the foramen opticum, then passing forwards and outwards beneath the frontal nerve, and becoming subsequently broad, it bends down in front of the eye, where it ends in a dense cellular expansion inserted into the superior border of the tarsal cartilage, and into the superior palpebral sinus of the conjunctiva, behind the palpebral ligament. On the upper surface of this muscle we find the frontal branch of the ophthalmic nerve, and the inferior surface is in contact for some distance with the rectus superior muscle, and then with the membrana conjunctiva, after it escapes from the orbit.

Recti Muscles.—The recti muscles are four in number, viz: the superior, inferior, external, and internal rectus. The superior is called attollens oculi, the inferior depressor oculi, the internal adductor, and the external abductor oculi. These four muscles take their origin from the periosteum around the optic foramen, the external muscle having an additional attachment to the foramen lacerum superius, the four muscles pass forward surrounding the optic nerve, but separated from it by the ciliary vessels and nerves, and by a quantity of fat; when they have advanced a little beyond the middle of the eye, they become tendinous, and are inserted about a quarter of an inch behind the cornea into the tunica sclerotica, all their tendons being connected together by an aponeurosis attached to the conjunctiva.

M. Bonnet, a French surgeon, gives these four muscles another insertion; he states that there is a fibrous capsule, (*Tunica vaginalis oculi*) lying between the globe of the eye and the layers of fat that are in the orbit; that this capsule

is concave and open in front, and terminates in the eyelids; and that it is inserted into the anterior extremity of the optic nerve, surrounding, without actual contact, the two posterior thirds of the eye. He says that the recti and oblique muscles pierce this capsule to reach the eye, and while traversing, form strong adhesions with it, thus giving these six muscles two insertions each, one into this capsule and another into the tunica sclerotica.

Thus M. Bonnet accounts for the want of success that frequently follows the operation for strabismus. According to his explanation, the muscle still retains its power over the eye, through its insertion into this capsule, notwithstanding the division of its attachment to the tunica sclerotica. The upper surface of the superior rectus muscle is in contact with the levator palpebræ superioris muscle: the inferior surface is placed upon the optic nerve, ophthalmic artery, and nasal branch of the ophthalmic nerve, a branch of the fifth. The superior surface of the inferior rectus is in relation with the optic nerve, and a branch of the third pair, the inferior surface being separated from the floor of the orbit by cellular tissue. The rectus internal muscle runs along the inner wall of the orbit, its external surface being in apposition with the ball of the eye. The outer surface of the external rectus muscle is in apposition with the orbit and lachrymal gland; the inner surface with the optic nerve, the sixth or abducens nerve, and the lenticular ganglion.

Superior Oblique Muscle.—This muscle is at the upper and inner side of the orbit; it arises internal to the levator, from the foramen opticum, and runs forwards along the os planum, then becomes a round tendon which plays through the fibro-cartilaginous pulley attached to the inner angle of the os frontis: this tendon is then reflected backwards, outwards, and downwards, between the superior rectus and the eye-ball, where it becomes broad, and is inserted

into the sclerotic coat of the eye, between the superior and external recti muscles, nearly midway between the entrance of the optic nerve, and the insertion of the superior rectus muscle.

Inferior Oblique Muscle.—This muscle is situated at the inferior and anterior part of the orbit. It arises tendinous from the orbital edge of the superior maxillary bone, above the infra-orbital foramen, and external to the lachrymal sac. It ascends obliquely outwards and backwards, below the inferior rectus; and is inserted by a tendinous expansion into the sclerotic coat behind the transverse axis of the eye. The inferior surface of this muscle is on the floor of the orbit; the superior corresponds with the ball of the eye and the rectus inferior.

ANATOMY OF THE PALPEBRÆ.

The palpebræ are composed of skin, sub-cutaneous cellular tissue, muscle, cartilage, cellulo-ligamentous tissue, glands and mucous membrane. The superior palpebræ are larger than the inferior, and cover nearly three-fourths of the globe of the eye when the lids are closed. Both of them are concave posteriorly, closely fitting to the surface of the eye. Their margins are thick, furnished anteriorly with the eye-lashes, and posteriorly with numerous mucous follicles. These opposed edges are sloped off obliquely towards the eye, so that when the lids are closed, a sort of triangular canal is formed, the base of which is the surface of the eye. When the integuments and sub-cutaneous cellular tissue are removed from the eye-lids, the orbicularis muscle is exposed to view.

Orbicularis Palpebrarum Muscle.—This muscle is broad, thin, and of an oval shape, it surrounds the base of the orbit, and occupies a great portion of the face. It arises by several fleshy fibres from the internal angular process of the os frontis, and from the upper edge of the tendo

oculi; the fibres proceed in curves, upwards, and outwards, along the upper edge of the orbit, eyelid, and tarsal cartilage, as far as the temple, and external commissure of the eye-lids; there the fibres curve in a similar manner along the lower eye-lid, and inferior edge of the orbit, till they arrive at the internal canthus, where they are inserted into the nasal process of the superior maxillary bone, and the inferior edge of the tendo oculi. The external or orbital fibres of this muscle are strong and red, and run circularly around the base of the orbit; the middle or palpebral fibres are pale, thin, and scattered; the internal or ciliary fibres adhere more closely to the skin, and present an elliptical appearance, because the fibres from the upper and lower lids intersect each other at the outer canthus, and adhere to the ligament of the external commissure.

Tendo Oculi Muscle.—The tendo oculi, or tendo palpebrarum, is a small muscle of about a quarter of an inch in length, inserted internally into the upper end of the nasal process of the superior maxillary bone; it crosses the lachrymal sac a little above its centre. From the edges of this muscle a strong aponeurosis is given off, which covers the whole of the anterior surface of the lachrymal sac, adhering to the margins of its bony gutter, where it becomes continuous with the periosteum. This tendon can be seen or felt during life through the integuments, particularly when the muscle is in action, or when the eye-lids are drawn towards the temple; it passes outwards and backwards to the internal commissure of the eye-lids, where it divides into two slips which enclose the caruncula lachrymalis, each slip being inserted into the tarsal cartilages and lachrymal ducts.

Tensor Tarsi Muscle.—This little muscle (which is called Horner's muscle) arises tendinous from the posterior edge of the os unguis, passes forward between the conjunctiva

and the expansion of the tendo oculi, then divides into two portions which are inserted into the lachrymal sac, and ducts, along which the fibres extend nearly to the puncta.

Corrugator Supercilii Muscle.—This muscle arises fleshy and tendinous from the internal angular process of the os frontis, then passes upwards and outwards, and becomes inserted into the middle of the eye-brow, where it becomes mixed with the fibres of the orbicularis and occipito frontalis muscles.

Tarsal Cartilages.—These two cartilages are thin, elastic plates, one situated in the superior, the other in the inferior eye-lid. The superior is of a semi-lunar shape, and larger than the inferior, which is long, narrow, and nearly straight. The ciliary margins of both are thick; the orbital edges are thin, and connected to the orbit by the palpebral ligaments, which are a continuation of the periosteum, their strongest part being towards the temple, where they decussate, and unite the cartilages at their external commissure; the tendo oculi fixing them internally.

Meibomian Glands.—The meibomian glands (or follicles, as they are sometimes termed) are situated on the posterior surface of the tarsal cartilages, arranged in nearly parallel and vertical rows. They are more numerous in the upper than in the lower lid. Small ducts lead from them, which open in the edge of each tarsus behind the cilia.

Cilia.—The cilia or eye-lashes arise from the bulbs that are beneath the skin; those of the upper eye-lid are more numerous than these of the lower; both are curved convex towards each other.

Membrana Conjunctiva.—The membrana conjunctiva is the mucous membrane lining each palpebra, and is continuous at their margins with the integuments. It also covers the anterior part of the eye-ball, being reflected on it from the palpebræ. Near the inner canthus of the eye, this membrane is thrown into a fold by the caruncula lachrymalis,

which fold is called the *semi-lunar fold*. This membrane next lines the lachrymal ducts and sac, and nasal duct; and finally becomes continuous with the mucous membrane of the nose.

This membrane is loosely connected with the sclerotic, and becomes delicately fine as it approaches the cornea, to which it becomes so adherent as to render it impossible to remove it, except it be macerated previously, or changed by disease. It is more vascular on the palpebræ and caruncula, than it is on the surface of the eye.

Caruncula Lachrymalis.—The caruncula lachrymalis is a small fleshy looking tubercle, somewhat of a conical figure. It is situated at the internal canthus, and is composed of a few mucous follicles and the bulbs of some hairs which project from its surface.

ANATOMY OF THE EXCRETING LACHRYMAL ORGANS.

Puncta Lachrymalia.—The puncta lachrymalia are two small holes situated in the edges of both lids, in little cartilaginous projections, about two lines from the inner canthus; each of these puncta is an orifice of the lachrymal ducts. When the lids are closed, both puncta meet.

Lachrymal Ducts.—These ducts are very small, and lead from the puncta to the lachrymal sac, into which they open, at its superior and external part, sometimes by one, and sometimes by two distinct orifices, behind the tendo oculi, a process of which surrounds each duct.

Lachrymal Sac.—The lachrymal sac is a small oval pouch of mucous membrane, situated in the fossa formed in the anterior surface of the os unguis at its junction with the nasal process of the superior maxillary bone. This sac is closed *superiorly*, with the exception of the openings of the lachrymal ducts. It terminates *inferiorly* in the nasal duct and is covered by integument, tendo oculi, and fibres of the orbicularis muscle.

Nasal Duct.—The nasal duct is situated in the nasal canal, and is in reality a continuation of the lachrymal sac :—it opens beneath the inferior spongy bone of the nares, by a small slit-like orifice, about an inch from the anterior nares, which is surrounded by a circular fold of mucous membrane. While passing through the canal, it is closely attached to the periosteum.

Nasal Canal.—The nasal canal is about three quarters of an inch in length ;—its *superior* orifice is situated in the internal angle of the base of the orbit ; and its *inferior*, in the inferior nares ; its course is downwards, backwards, and a little outwards. The superior part is formed by the fossa in the nasal process of the superior maxillary bone, and os unguis. Its inferior part is bounded *internally* by the external side of the inferior spongy bone, and *externally*, by the perpendicular plate of the superior maxillary bone.

If a common probe were passed into each nasal canal, the points would be found to touch each other in the median line, opposite the superior part of the os frontis.

CHAPTER II.

THE ANATOMY OF THE VESSELS AND NERVES OF THE ORBIT, AND THE ANATOMY OF THE GLOBE OF THE EYE.

Arteries of the Orbit.—All the arteries of the orbit are branches of the *ophthalmic*, except the infra-orbital, which is the eighth branch of the internal maxillary.

The infra-orbital artery enters the canal of the same name, and after traversing it, escapes through the infra-orbital foramen, where it is distributed to the muscles of the face, and anastomosis with other arteries in that region.

Ophthalmic Artery.—The ophthalmic artery is one of the terminating branches of the internal carotid. It is given off close to the anterior clinoid process of the sphenoid bone; it immediately enters the optic foramen, below and external to the optic nerve. When it enters the orbit, it rises above the optic nerve, and then bends down to the inner side of the orbit, along which it passes to the inner canthus, where it terminates.—In its course, it gives off ten branches, viz:—

1st. *The Arteria Centralis Retinæ*, which is the first branch of the ophthalmic. It is exceedingly slender, perforating in an oblique manner the neurilemma, until it reaches the centre of the optic nerve, which position it keeps till it enters into the eye, where it divides into delicate ramifications, spreading along the internal layer of the retina, one or two branches piercing the vitreous humour, and extending to the capsule of the lens.

2nd. *Lachrymal Artery.*—The lachrymal artery is the second branch of the ophthalmic. Its course is along the external rectus muscle. It supplies the lachrymal gland, and external part of the palpebra.

3rd. *Supra-Orbital Artery*.—The supra-orbital artery is the third branch of the ophthalmic; it passes along the levator palpebra muscle, and escapes through the supra-orbital foramen, after which it supplies the muscles and integuments of the eye-brow; then ascending on the forehead, it divides into several branches, which are distributed to the scalp, and finally communicates with the temporal and occipital arteries.

4th. *Posterior Ciliary Arteries*.—These very small arteries are ten or twelve in number, and are given off by the ophthalmic, they surround the optic nerve, and pierce the back part of the sclerotic coat of the eye; then passing between it and the choroid, are distributed to the latter tunic, some branches continuing as far as the ciliary process and the iris.

5th. *Long Ciliary Arteries*.—These arteries are two in number; although called the fifth branch of the ophthalmic, one is situated on either side of the optic nerve; they penetrate the posterior part of the sclerotic coat, then pass between it and the choroid, till they arrive at the ciliary circle, where they form, by their anastomosis, a net work on the great circumference of the iris. From the inner part of this arterial circle, other smaller branches proceed, and form a second circle within the former, and these again form a third circle, which immediately surrounds the pupil.

6th. *Supra and Infra Muscular Arteries*.—The supra and infra muscular arteries are the sixth set of branches given off by the ophthalmic, and are distributed to the muscles of the eye, the periosteum of the orbit, and the tunica vaginalis oculi.

7th. *Æthmoidal Artery*.—The æthmoidal is the seventh branch of the ophthalmic artery. It leaves the orbit through the posterior orbital foramen, and goes to supply the mucous membrane of the æthmoid cells.

8th. Superior and Inferior Palpebral Arteries.—These branches are the eighth set given off by the ophthalmic; they supply the palpebræ, the caruncula lachrymalis, the conjunctiva, and the lachrymal sac.

9th. Nasal Artery.—The nasal is the ninth branch of the ophthalmic artery; it passes along the side of the nose, and inosculates with the labial artery.

10th. Frontal Artery.—The tenth and last branch of the ophthalmic, is the frontal artery; it and the nasal are the terminating branches of the ophthalmic,—after passing out of the orbit, it ascends to the eye-brow and forehead.

ANATOMY OF THE NERVES OF THE EYE AND ORBIT.

The nerves connected with the eyes and orbits are the *optic* or second pair of cerebral nerves; the *motores oculorum*, or third pair of cerebral nerves; the *nervi pathetici*, or fourth pair of nerves; the ophthalmic branch of the fifth, and the sixth pair of nerves; and the orbital branch of the superior maxillary.

Optic Nerve.—The optic nerve (or second cerebral) enters the orbit through the optic foramen, where it becomes surrounded with a strong sheath derived from the *dura mater*: after this nerve enters the orbit, it is surrounded by the four recti muscles, but separated from them by fat, cellular tissue, and the ciliary vessels and nerves. Its course, when in the orbit, is forward, and a little inwards, so as to form a slight curve, the convexity of which looks outwards; it then pierces the sclerotic and choroid coats of the eye, and terminates by expanding into the retina. In addition to the *dura mater*, as a covering, this nerve possesses a very dense neurilemma, which sends in numerous processes to form small canals or tubes, in which the nervous substance is contained, so it is to be remarked that this is not formed like other nerves whose several filaments are placed parallel to each other. If the white substance of

this nerve be removed by maceration in an alkali, its cellular structure will become obvious.

Orbital Plexus of Nerves.—At the side of the body of the sphenoid bone, the four following nerves lie according to their numerical order; *superiorly*, the third, next to it, the fourth, then the ophthalmic branch of the fifth, and lastly, the sixth. These nerves are closely connected together, thereby forming a kind of plexus, which is termed the orbital plexus.

When these nerves arrive at the anterior clinoid process of the sphenoid bone, they separate, and as they enter the foramen lacerum superius, they lie thus;—superiorly the fourth, next the frontal twig of the ophthalmic branch of the fifth; then the superior division of the third; and lastly, lying inferior to the whole, is the sixth nerve, with which latter the ascending branches of the superior cervical ganglion of the sympathetic are intimately connected.

Third pair of Nerves.—The third pair of nerves are called the *motores oculorum*. In passing through the foramen lacerum orbitale, each of these nerves divides into two branches, viz;—a superior and inferior branch. The former is the smaller, and passes between the heads of the external rectus muscle, and over the optic and nasal nerves; it then divides into two branches, the smaller and shorter of which supplies the superior rectus,—the other branch supplying the levator palpebra muscle. The inferior or second branch of the third pair passes *inferiorly* and *externally* to the optic nerve, and divides into three branches, viz,—an internal, middle, and external branch.

The internal branch is the largest, and passes obliquely downwards, forwards and inwards, beneath the optic nerve, then getting to the internal side of the optic nerve, it is distributed to the internal rectus muscle. The middle branch goes directly to the inferior rectus muscle. The external branch passes downwards and forwards on the

surface of the inferior rectus muscle, (but giving no filaments to it,) till it terminates in the inferior oblique muscle. This last mentioned branch gives off, at its root, a small filament to the lenticular ganglion. The reader will perceive that five out of the seven muscles of the orbit are supplied with branches of the third nerve. The name of the muscles being, the superior, inferior, and internal recti, the levator palpebra, and the inferior oblique.

Trochleator, or Fourth Nerve.—The fourth nerve enters the orbit by the foramen lacerum, then ascends obliquely forwards and inwards, above the levator and superior rectus muscles, and is then distributed to the orbital surface of the superior oblique muscle. As this nerve enters the orbit, it mounts above the third and fifth, becoming the highest nerve in the orbit. As it passes over the fifth, it is usually connected to that nerve by a fine filament.

Trigemini, or Fifth Nerve.—The fifth nerve having formed the semi-lunar or cassarian ganglion, separates into three, viz,—The ophthalmic, the superior, and inferior maxillary nerves.

The Ophthalmic Nerve.—The ophthalmic nerve, or more properly, the ophthalmic branch of the fifth nerve, passes along the outer side of the cavernous sinus, below the third and fourth, and above the sixth nerves, in which situation it receives some filaments from the sympathetic nerve; as it approaches the foramen lacerum orbitale, it separates into three branches, viz:—the *lachrymal, frontal and nasal* nerves.

Lachrymal Branch of the Fifth Nerve.—The lachrymal is the most diminutive and external branch of the ophthalmic; it passes forwards and outwards to the lachrymal gland; in its course, it passes over the external rectus muscle, is surrounded by fat, and accompanied by the lachrymal artery. This nerve, in its course, sends off two small branches, one that passes through the sphenomaxil-

lary fissure to communicate with the superior maxillary nerve; the other branch goes through the malar bone to communicate with the facial nerve. As the lachrymal nerve approaches the gland, it enlarges, separates, sends four or five branches to the inferior surface of the gland, and terminates in several fine soft filaments on the conjunctiva lining the superior palpebra; it also extends to the cellular membrane, between the gland and malar bone.

Frontal Nerve.—The frontal nerve is the second division of the ophthalmic branch of the fifth; it enters the orbit above the superior rectus muscle, and thence passes forwards along the upper surface of the levator palpebræ; near the superciliary arch it divides into two branches, one internal called the supra-trochleator; the other external, the supra-orbital.

Supra-Trochleator Nerve.—The internal is the smallest branch of the frontal nerve; it runs forwards and inwards above the trochlea of the superior oblique muscle. It is distributed to the corrugator supercillii, orbicularis palpebrarum and occipito-frontalis muscles. It also supplies the integuments of the forehead and superior eye-lid. It communicates with the infra trochleator branch of the nasal nerve, and sends one or two small branches into the frontal sinus.

Supra Orbital Nerve.—This is the second branch, or more properly, the true frontal nerve. It passes through the superciliary notch, which latter aperture is, according to its formation, sometimes called *the superciliary foramen*. It then ascends on the forehead and divides into two branches, which again subdivide into numerous filaments, all of which are distributed to the muscles and integuments of the scalp, many of them taking a very long course and communicating with the portio dura, and with the occipital nerves and their fellows of the opposite side.

Nasal Nerve.—The nasal nerve is the third and last branch of the ophthalmic division of the fifth cerebral nerve. It enters the orbit beneath the frontal nerve, and between the two heads of the external rectus muscle. It then continues its course obliquely forwards and inwards, above the optic nerve, and below the superior rectus muscle. It next runs along the inner side of the orbit, below the superior oblique muscle, where it divides into two branches, viz:—*the infra-trochleator*, and *nasal nerve proper*. The nasal nerve, before it enters the orbit receives a branch from the sympathetic, and, after entering the orbit, while on the outside of the optic nerve, it gives off a delicate branch (about an inch in length) to the lenticular ganglion. As it passes over the *optic*, it gives off the two *ciliary nerves*.

Infra-Trochleator Nerve.—The infra-trochleator is the first and external branch of the nasal division of the fifth. It runs forwards beneath the pulley of the superior oblique muscle, and divides itself into several filaments, which communicate with the supra-trochleator nerve, and is finally distributed to the lachrymal passages, and to the integuments and muscles on the side and dorsum of the nose.

Nasal Nerve Proper.—The second or internal branch of the nasal division of the fifth is the *true* nasal nerve. It passes through the anterior of the internal orbital holes into the cranium, crosses the cribriform plate of the ethmoidal bone, and descends by the side of the crista galli into the nasal fossa, where it divides itself into posterior and anterior filaments; the former are distributed to the septum, the latter descend behind the nasal bones, and are lost in the integuments in the tip of the nose.

Sixth or Abducens Nerve.—The sixth nerve, when in the cavernous sinus, is joined by a branch of the sympathetic; it afterwards enters the orbit through the lower part of the foramen lacerum orbitale, beneath all the orbital nerves,

except the ophthalmic, over which it passes. After entering the orbit, it proceeds forwards and outwards, and is distributed to the ocular surface of the external rectus muscle.

It is worthy of remark that all the motor nerves in the orbit are distributed to the *ocular* surface of their respective muscles, except the fourth, which spreads its branches on the *orbital* surface of the superior oblique.

Infra-Orbital Nerve.—The superior maxillary nerve, after giving off the two descending branches which join the sphenopalatine ganglion, sends off the orbital branch which ascends through the sphenomaxillary fissure, and divides into two branches, viz;—the *malar*, and the *temporal*. The malar communicates with the lachrymal nerve, passes through a small canal in the malar bone, and is distributed to the integuments and muscles covering that bone. The temporal branch passes through it into the temporal fossa, pierces the temporal fascia and becomes cutaneous,—then joining some branches of the facial nerve, it accompanies the temporal artery, and is lost in the integuments of the temple and head. The *infra-orbital nerve* is the last or terminating branch of the superior maxillary; it proceeds along the floor of the orbit in the infra-orbital canal, and escapes through the infra-orbital foramen, where it divides itself into several branches which are distributed to the palpebræ, cheek, alæ nasi, and upper lip. All these different branches frequently communicate on the face with the portio dura, and on the side of the nose with the nasal nerve.

Lenticular Ganglion.—The lenticular ganglion is a small reddish coloured body, situated near the back part of the orbit between the optic nerve and external rectus muscle; it is surrounded by fat, and is of an irregular square form. At its superior angle, it receives a filament from the nasal branch of the ophthalmic, and, at its posterior and inferior

angle, a twig from the inferior oblique branch of the third cerebral nerve.

From the anterior angles of this ganglion, two fasciculi of fine nerves proceed, which are termed ciliary,—the inferior being larger than the superior.

Ciliary Nerves.—The ciliary nerves are about twenty in number, eight or ten of which are in the inferior fasciculus, and about six in the superior, and there are three and sometimes or four internal, which arise from the nasal nerve.

The ciliary nerves twine around the surface of the optic, accompanied by the ciliary arteries, and with them pierce the back part of the sclerotic coat; they then become flat, and proceed forwards in parallel grooves on the inner surface of the tunica sclerotica, having but little connexion with the choroid coat: at the anterior part of the eye, they meet the ciliary ligament, in which most of these nerves are lost, but on each side, one or two branches may be traced through it to the iris, where they divide into numerous filaments of extreme minuteness.

GLOBE OF THE EYE.

The globe of the eye is situated in the orbit behind the conjunctiva. It is surrounded by the orbital muscles already described, and is connected posteriorly to the optic nerve.

The axes of the eyes differ from those of the orbits, the former being parallel to each other. The globe of the eye is nearly spherical, its antero-posterior axis being about two lines greater than the transverse axis; this difference is due to the cornea being a segment of a smaller circle than the sclerotic. The diameter of the eye in its axis is about one inch.

The eye is composed of fluids or humours enclosed in different tunics, of which the first is the sclerotic or fibrous coat, the second the choroid or vascular coat, and the third the retina or nervous coat.

Each of the humours also has a distinct capsule, independent of the tunic. The first or anterior humour is the aqueous; the second or middle, the crystalline; and the third or posterior, the vitreous.

To dissect the eye, it should be removed from the orbit; the conjunctiva must be first cut through, then the insertions of the recti and oblique muscles; lastly, the optic nerve must be divided close to the optic foramen, leaving as much of it as possible attached to the globe.

Tunica Sclerotica.—The sclerotic coat of the eye is a dense opaque fibrous membrane, extending from the optic nerve to the cornea; at its posterior part, it is perforated by the optic nerve, at about a line, internally to its centre, where this nerve perforates. If the sclerotic coat be examined on its concave surface a small conical aperture presenting a cribriform appearance will be observed. This appearance is due to the central artery and vein of the retina, which accompany the optic nerve through this opening. The sheath of the optic nerve is continuous with the fibres of the sclerotica. If a vertical section of this tunic be made from the front, backwards, it will be seen that its thickest part is at the optic nerve, that it becomes thin in the middle, and is again thickened at its anterior part by the tendinous expansion of the muscles inserted into it.

The tunica sclerotica consists of fibres which run in every direction, but do not form distinct laminae. Its internal surface is concave, smooth, and of a glistening appearance;—between it and the choroid coat run the ciliary vessels and nerves. Anteriorly the sclerotic coat receives the cornea; both are sloped off obliquely, and slightly grooved; the sclerotica overlaps the cornea, and their connexion is still further secured by the conjunctiva anteriorly, and the membrane of the aqueous humour posteriorly; they can only be separated by maceration.

The Cornea.—The cornea is nearly circular; its transverse diameter, however, is a little greater than its vertical. It constitutes about the anterior fifth of the eye, and though not of a fibrous texture, consist of laminae, connected together by a fine cellular tissue. It is smooth and perfectly transparent, its convex or anterior surface is covered by conjunctiva, which is only separable from it by maceration; its posterior or concave surface is lined with a fine elastic membrane, which is not, as some have supposed, a part of the membrane of the aqueous humour, but is one *sui generis*, that continues to preserve its proper curve and transparency, after the cornea has been separated by maceration. That it is endowd with true elastic cartilaginous properties, is proved by its curling upon itself when it is cut. In the child the cornea is thick and pulpy, while in the adult it is often so hard as to cause the point of the knife to bend on it, while the operation for extracting cataract is being performed. The laminae of the cornea are connected by loose cellular tissue, which can be easily demonstrated by rubbing the cornea between the finger and thumb, when it will be found that the layers glide freely over each other.

The cornea is supplied with blood vessels, nerves, and absorbents. Blood vessels and absorbents, however, cannot be dissected in it, so their existence must be proved by physiology and pathology; but the nerves can be seen in the cornea if the plan recommended by Pappenheim be adopted, who found that he could distinctly trace the nerves from the sclerotica into the substance of the cornea, after having immersed the cornea in acetic acid, or a solution of caustic potass. He gives three facts in proof that the nerves thus traced belong to the cornea. *1st.*—If the corneal conjunctiva be removed, the nervous filaments are on the inner and not on the outer surface of the corneal epithelium. *2nd.*—The removal of the iris and membrane

of the aqueous humour makes no difference as to the facility with which the nerves can be seen. *3rd.*—The nerves are distinctly visible entering the margin of the cornea, but less so towards its centre, where they are ultimately lost between the laminae. To see the nerves, he placed the cornea between two plates of glass, and immersed the whole in water, making gentle pressure, and keeping the concave surface turned upwards; he found the light of a lamp necessary, and sometimes a slight magnifying lens.

Choroid Coat.—The choroid is the second and vascular coat of the eye. It is best seen by making the following dissection:—The eye should be placed in a shallow vessel containing a sufficient quantity of water to allow of its being occasionally immersed, a small incision must be then made in the sclerotica, and through the opening thus effected, air should be introduced by means of a fine tube, and thus the sclerotica will become separated from the choroidea, after which the sclerotica can be dissected off with a pair of scissors as far as the cornea, where it will be found adherent to the ciliary ligament, from which it can be easily separated with the handle of a dissecting knife. Half of the cornea may then be removed, when the choroid coat and its appendages will be fully brought into view. Its appendages are the ciliary ligament, ciliary processes, and the iris.

The choroid coat is situated between the sclerotica and the retina. It reaches from the optic nerve to the ciliary ligament, where its external layer terminates, but its internal layer continues inwards in the form of folds, called the ciliary processes.

The optic nerve passes through a round opening in the posterior part of this tunic, but the edges of the opening are not in actual contact with the nerve.

The choroid coat is more dense anteriorly than posteriorly; its external surface is smooth and loosely connected to the sclerotica, by the ciliary vessels and nerves, and also

by fine cellular tissue. It is divisible into two layers, an external and internal,—on the external are numerous fine vascular ramifications, running in parallel arches; these are chiefly formed by veins, and are termed the *vasa vorticosa*.

The second coat of the choroid is called after its discoverer, the *membrana Ruyschiana*. It can be separated from the outward layer by dissection; its internal surface, which is next the retina, is covered by a brown pigment which is thicker anteriorly than posteriorly; this pigment is deficient for a small space round the optic nerve, and can be washed off the surface of the membrane with water; it is totally wanting in those anomalies called Albinos, and they are therefore unable to see distinctly in broad daylight.

The ciliary arteries supply the choroid coat with blood.

Ciliary Ligament.—The ciliary ligament corresponds to the junction of the iris and choroidea, and of the cornea and sclerotica. It forms a ring of a grey colour about two lines broad, and of a soft cellular texture.

Ciliary Muscle.—This is a muscle described by Mr. Todd in the third part of his work on the Physiological anatomy and Physiology of man. I have sought for such a muscle but could not find it; indeed I conceive it to be nothing more than a part of the ciliary ligament; however I would hesitate before doubting such an authority as Mr. Todd. It would appear as if the search for this muscle was caused by the received opinions of old authors that the change which the eye underwent, to adapt itself to near and remote objects, was produced by some change in the lens; but they were unable to point out any means whereby this lens could be moved. According to Mr. Todd's idea, however, this ciliary muscle moves the lens and the ciliary processes towards the cornea. The following quotations will explain, his views, (Page 21.) "The choroid, on coming up to the cornea, gives off its process the iris, and it there adheres intimately to the sclerotic by a very narrow ring of white tissue,—the ciliary

ligament. For an eighth of an inch behind this, however, it is coated by a semi-transparent band, which we shall distinguish as the *ciliary muscle*, and the fibres of which radiate from the cornea." (Page 24.)—"The description of the choroid now given refers only to the portion of it which corresponds to the retina, and this latter membrane ceases at a line (*ora serrata*) about an eighth of an inch behind the margin of the cornea. In front of this line, and as far as the iris, the choroid is known as the *ciliary body*, being modified to form the *ciliary processes*; and it is covered on its outer surface by a semi-transparent tissue, the *ciliary muscle*, at the anterior edge of which is a more opaque white ring, the *ciliary ligament*."

(Page 29.)—"The *ciliary muscle* is that grayish, semi-transparent structure behind the ciliary ligament, and covering the outside of the ciliary body. It has been described as muscular by many of the older anatomists, especially by Porterfield, while others have assigned to it a different character. Lately it has been so regarded by Wagner and Dr. Wallace of New York, and we believe correctly. It belongs to the unstriped variety of muscles, and its fibres appear to radiate backwards from the junction of the sclerotic and cornea, and to lose themselves on the outer surface of the ciliary body. The more superficial fibres are in contact with, but scarcely adhere to, the sclerotic, and are inserted into the posterior part of the ciliary body; while the deeper ones seem to dip behind the iris, to the more prominent parts of the ciliary processes which approach the lens. The ciliary muscle must have the effect of advancing the ciliary processes, and with them the lens, towards the cornea. The ciliary nerves pierce this muscle on their way to the iris, distributing to it many filaments which may be seen for the most part to cross the fibres."

Ciliary Processes.—These are angular folds of the choroid coat, arranged in a radiated manner around the lens, on the

fore part of the vitreous humour; they are about sixty or seventy in number; each of them extends as far as the lens, running inwards and backwards from the ciliary ligament. These processes, as well as the interstices between them, are covered with *pigmentum nigrum*. To this part Sir C. Bell gave the name of *corona ciliaris*, or ciliary circle. The anterior edge of each process is connected to the ciliary ligament and iris; the posterior edge is attached to the vitreous humour, and the internal edges are perfectly loose and floating, forming the circumference of the posterior chamber of the eye.

If the vitreous humour and lens be removed from the eye, there will be seen a striated mark on the vitreous humour and round the lens, called the *ciliary disk*, and is formed by the intervening pigment, after the ciliary processes have been removed.

The ciliary processes are of a vascular structure, and their contorted arteries can be traced from the extreme branches of the choroid coat. These processes are connected to the lens *indirectly*, that is, their posterior edges are attached to the layer of the hyaloid membrane, covering the vitreous humour, and passing over the lens. By these processes vessels are conducted to the lens.

Iris.—The iris is a very delicate membrane of a circular form; and considered by Mr. Todd as a process of the choroid,* it floats in the aqueous humour, and is suspended vertically behind the cornea, so as to divide the space between it and the lens into two apartments, viz:—the anterior and posterior chambers of the eye. The iris is fixed, by its external border, to the ciliary ligament; part of its posterior surface is attached to the same and to the ciliary processes. Through the iris, there is a round aperture a little nearer to its nasal than its temporal side, which aperture forms the

* R. B. Todd on the Physiology of Man,—Part 3, page 24.

communication between the two chambers of the eye, and is called the pupil. The posterior surface of the iris is covered with pigment, and, in this place, is called the *uvea*. The anterior surface of the iris is striated with different colored lines, some of which take a radiated course from the circumference towards the pupil, near which they cross each other, then separate and again unite, appearing to form, or to end in a fasciculus of circular fibres of a darker tint bordering the pupil.

The iris is composed of muscle, vessels and nerves. Physiology fully proves the muscularity of the iris; but the muscular fibres may be also demonstrated, on its posterior surface, large enough to be raised with a needle or bristle, putting the fact beyond any doubt which may have heretofore existed on the subject. The arteries of the iris are derived from the long and posterior ciliary, and its nerves, with which it is well supplied, are derived from the nasal nerve, and lenticular ganglion.

In the fœtus the pupil is closed by a delicate and vascular membrane, called the *membrana pupillaris*, which is ruptured either at, or a short time previous to birth.

Retina.—The retina is the internal and nervous tunic of the eye, and is formed by the expansion of the optic nerve. This tunic is divisible into three layers; the first or external is the lamina serosa, the second, the lamina nervosa; and the third, the lamina vasculosa.

The external or serous layer is very delicate and difficult to dissect, but it may be separated from the second layer by pressure upon it with the handle of a scapel under water; it is called, the *membrana Jacobi*, after its discoverer, Doctor Jacob, of Dublin.

The middle or nervous layer is very soft and of a gray colour; it is the actual continuation of the optic nerve, and is therefore the true retina.

The internal or vascular layer is very delicate and lies on the hyaloid membrane.

The three coats of the retina run forward, in conjunction, from the optic nerve to within two lines of the lens, where the outer and middle coats terminate in an abrupt line, along which a small vessel runs. The internal or vascular coat continues its course over the lens, accompanied by the hyaloid membrane, to which it adheres. This vascular lamina of the retina is formed by the terminating branches of the central artery of the retina.

The concave surface of the retina is best seen by cutting a fresh eye transversely, and allowing all the humours to fall out.

When looking at the concave surface of the retina there is to be seen in the centre of the optic nerve a small dark point, which is the central artery of the retina, and is generally called the *porus opticus*.

In the axis of the eye, which is about two lines external to this point, there is a small yellow or orange spot, called the *punctum aureum*, or spot of Sæmmering; around this spot the retina is thrown into folds.

The retina is transparent in the recent eye, but it soon becomes opàque after death; it also becomes slightly opaque if immersed in diluted spirits of wine, which it should be for dissection.

Aqueous Humour.—The aqueous humour fills the anterior and posterior chambers of the eye; it is a perfectly colourless fluid, and is about five grains in weight. This fluid is secreted by its own capsule or membrane, which membrane lines the concave surface of the cornea, and is continued from it over the anterior part of the iris, then passes through the pupil, and lines the posterior surface of the iris from which it is reflected to the anterior surface of the capsule.

of the lens.* This aqueous capsule is a serous membrane.

The anterior chamber of the eye is bounded anteriorly by the posterior or concave surface of the cornea, and posteriorly by the anterior surface of the iris. The posterior chamber is bounded anteriorly by the posterior surface of the iris, and posteriorly by the anterior surface of the capsule of the lens, and laterally, by the internal edges of the ciliary processes.

The anterior chamber of the eye is the largest, being about two lines in depth, while the posterior does not exceed half a line.

Crystalline Humour.—The crystalline humour is a transparent double convex lens, a little more convex posteriorly than anteriorly, its anterior surface appearing as though it had been a little flattened or pressed. This lens is imbedded in the vitreous humour behind the anterior third of the eye, something nearer to its nasal than its temporal side, and having its axis corresponding to that of the pupil.

The lens is surrounded by a fine capsule, which is thin and soft *posteriorly*, but dense and elastic *anteriorly*. Between the lens and its capsule, there is a very small quantity of fluid, which is called *liquor morgagni*. The lens is kept in its place by the hyaloid membrane, which, on its arrival at the edge of the lens, splits into two layers, one running *posteriorly*, and the other becoming connected with the vascular coat of the retina, and consequently forming a much denser membrane, runs anteriorly to the lens.

These layers, in separating, form with the lens a triangular canal, of which the lens is the base. It is called, after

*Mr. Todd does not believe this, but I think pathology fully proves it, from the rapidity with which adhesions take place between the iris and capsule of the lens in cases of iritis which would not be likely to occur, if they were not covered with a serous membrane; speaking of the membrane of the aqueous humour, he says: "This epithelium is probably concerned in the secretion of the aqueous humour, but it does not extend over the whole surface with which that fluid is in contact. It is probably limited to the cornea.—*Physiology of Man*, by Todd—Part 3, page 21.

its discoverer, the canal of Petit. It is intersected by fine septa composed of vessels and nerves of the lens, so that when it is distended with air, it presents a cellular or vesicular appearance.

Although the lens is called one of the humours of the eye, yet it is very different from the others, for it is a compact substance, soft and pulpy externally, but dense towards its centre, or rather a little internal to it. It is of a fibrous structure, and, when boiled, separable into wedge or triangular shaped pieces, each piece composed of successive plates, and each plate of fibrous structure.

The lens is supplied with vessels and nerves from the ciliary by the ciliary processes. The capsule is supplied with arterial blood from the extreme branches of the central artery of the retina.

The lens in the foetus is very vascular and soft ; in the adult, it is perfectly transparent ; and in the very old, it has an amber or yellowish tint towards its centre.

Vitreous Humour.—The vitreous humour is so thin in consistence as to be almost watery ; it derives its gelatinous appearance from being enclosed in the hyaloid membrane. This membrane not only encloses the vitreous humour, but sends processes into it, dividing the whole mass into numerous cells, all of which communicate so freely with one another, that air, injected into one, will rapidly distend the whole, or if one or two openings be made into the capsule, the whole of the fluid will gradually escape.

The vitreous humour, with its capsule, fills the two posterior thirds of the globe of the eye.

Anteriorly the crystalline lens is connected to it, as has been already described. External to the lens, upon the hyaloid membrane, is the ciliary disk.

CHAPTER III.



PHYSIOLOGY OF THE ORBIT AND ITS CONTENTS.

AUTHORS, generally when writing on the physiology of the eye, have suffered nearly all their attention to be given to the globe, to the exclusion of its appendages ; in acting thus, it is unnecessary to say, that they have committed a great error ; for indeed the globe of the eye would be of but little use, if it were not for its appendages. In this chapter will be given the physiology of every part connected with the eye, both separately and collectively, and it will be shewn that the different conditions of the retina are accompanied by appropriate conditions of the surrounding muscles.

ORBIT.

As a general rule, in the animal economy it is found that the more important a part is, the more carefully it is secured from external violence ; of the many examples to prove this, the brain is the most striking. We thus see that one very important use of the orbit is that it acts as a protective to the eye. *Secondly*,—It forms a socket in which the eye perform its different motions. *Thirdly*,—It gives attachment to its different muscles. And *fourthly*,—By its foramina, it transmits and protects the vessels and nerves going to and from the eye ; hence the orbit is indispensable to the well-being of the eye.

PERIOSTEUM.

The periosteum covering the bones of the orbit, is of the same use as that adhering to any other bones of the

body. It transmits the nerves and nutrient vessels to the bones, and gives attachment to some of the muscles, and forms a smooth surface for the parts in connexion with it to move upon: but the periosteum of the orbit does even more, for it becomes a protection to the anterior part of the eye, (for which it is well adapted by its great elasticity,) in consequence of its forming the palpebral ligament for the attachment of the tarsal cartilages.

FAT OF THE ORBIT.

The fat in the orbit serves, combined with the cellular tissue, to fill up the interstices between the muscles, to form a cushion for the eye-ball, and to protect it from being injured by the spasmodic contractions of the muscles of the eye, and by the concussion of blows. It is also of use in supporting the nerves and vessels supplying the eye-ball.

TUNICA VAGINALIS OCULI.

The use of this tunic is to prevent the muscles of the eye from pressing on the eye-ball, when the muscles forcibly contract.

VESSELS OF THE EYE.

There is but little to be said on the physiology of the vessels of the eye. There are but the two great vessels, of which all the others are branches, namely, the ophthalmic artery and vein; of course their use is to carry blood to and from the eye and its appendages.

Conditions of the Eye.—Before entering into the physiology of the muscles of the eye, either separately or collectively, it will be necessary to examine the different conditions and motions of the eye.

The eye is subject to two distinct states, viz:—rest and motion. It has been stated and believed that the controul of the eye is given up to one class of muscles, namely, the voluntary, during its state of activity, meaning watchfulness and the full exercise of the organ,—and that, on the other hand, it is assigned to the tutelary protection of the other class, the so called involuntary, during rest, by which is meant sleep, faintness, and insensibility. Now I consider that it is not very difficult to shew that both these statements are in a great degree wrong. As to the eye being given up altogether to the controul of the voluntary muscles, during its state of activity, such is not the case, although the statement rests upon the authority of Sir C. Bell. That the involuntary muscles constantly oppose the voluntary, and that too very successfully, even against the strongest efforts of the will, I will endeavour to prove in the course of this chapter; and I will endeavour also to demonstrate that it is actually necessary for the preservation of the eye, that such should be the case. The muscles of the eye-ball, which direct the eye to objects during the waking state, are most certainly strictly voluntary,* and always connected with the exercise of the sense of vision.

But the involuntary motions of the eye have nothing whatever to do with vision; they are performed without any effort of the will, solely and entirely for the preservation of the eye. Wishing to prove that during the condition of sleep, faintness or insensibility, the eyes are given up to the power of the involuntary muscles, Sir C. Bell adduces their vacant appearance, want of direction, and their whites being disclosed by the revolving of the eye-ball upwards. The fact is otherwise; during sleep, the eye-ball and its muscles are at *perfect rest*, and the eye is

*Unless we except the internal rectus which is considered to act automatically with the external rectus of the opposite side, and the two external recti which cannot be made to act consentaneously.

consequently in its natural position, that is to say, the cornea is turned a little upwards and inwards, but not nearly so much as when it is turned up during our waking moments by the action of the inferior oblique, which is an involuntary muscle, and acts only in obedience to reflex stimuli, or central irritation as in epilepsy. This is easily ascertained by examining the eye of a person asleep, when it will be found that the whole of the cornea can be explored on raising the upper eye-lid, and on the other hand, that no part or hardly any portion at least of the cornea can be seen when it is turned up by the action of the inferior oblique, however high we may raise the upper eye-lid.

Some of the muscles of the eye possess a compound function, that is, they are both voluntary and automatic, or in other words, they act both in obedience to, and independent of, the will. The different motions of the eye will be better explained, when giving the physiology of the muscles.

Recti Muscles.—The four recti muscles of one eye, without considering those of the other, may be said to be all voluntary, and their action, either separately or collectively, is completely under the influence of the will; still they cannot, at all times, obey it, in opposition to any of the involuntary muscles of the eye in action, as, for example, when the inferior oblique is acting.

This can be understood by a very common illustration: If a foreign body gets under the eye-lid, causing pain or irritation, the cornea becomes turned upwards through the reflexion of the inferior oblique, (which is an involuntary muscle), in opposition to the strongest efforts of the will that can be made upon the inferior rectus muscle to bring the cornea down, and keep it in that position.

The use of the four recti muscles, acting collectively, is to fix the eye when looking at any object; in this action, they are perfectly voluntary and obedient to the will. They

likewise prevent the eye-ball being protruded during the action of either of the obliques.

The separate actions of these muscles are as follows :— The superior rectus turns the eye upwards, the inferior downwards, the external outwards, and the internal inwards; and alluding to one eye only, *all* these separate actions are voluntary.

The recti muscles are the only voluntary muscles of the eye-ball, but under certain circumstances, they perform their action without the stimulus of the will; they cause the eye not acted upon by the will to rotate in the direction of the eye moved by the will. This movement is called *consentaneous*, and the muscles are said to act *automatically*, not voluntarily; the stimulus is probably reflex. The following are all the automatic movements :—

Right eye acting voluntarily.		Left eye acting automatically.	
Outwards.	Ext.	Rectus.	Internal Rectus.
Out and down.	Ext. and Infr. Recti.	Ext. and Infr. Recti.	Int. and Infr. Recti.
Out and up.	Ext. and Supr. Recti.	Int. and Supr. Recti.	Int. and Supr. Recti.
And <i>vice versâ</i> .			

In opposition to the opinion of other Physiologists, I maintain that these muscles, (the internal, superior and inferior recti,) are the only automatic muscles of the eye. The two oblique muscles, supposed by Carpenter and others to act sometimes automatically, or to be partly voluntary and partly involuntary, act *always involuntarily*: and are, as I shall presently show, absolutely dependent for their action, upon the movements of the orbicularis, or levator palpebræ.

The superior recti always act consentaneously to turn the eyes upwards, the inferior recti consentaneously to turn them downwards, the internal recti acting together voluntarily, as will be seen when we examine a very minute object, turn the cornea towards the nose.

The external recti never act consentaneously; the voluntary action of one external rectus being accompanied by the

automatic action of the internal rectus of the other eye, as already stated. The obvious harmony of this arrangement, in preserving the axis of vision perfect, is abundantly evident. It must be remarked, that any intermediate movements of the eye-balls, when the eyes are open, such as turning the eye upward and outward, upward and inward, &c., are due to the combined action of two recti muscles, and *in no such case* to the action of either of the *obliques*.

The rapid consecutive contractions of these four muscles, give that appearance to the eyes which is called rolling, and is perceived in persons when in a passion, drunk, or insane. But the appearance is deceptive; there is no such motion in the eyes as rolling.

Physiologists have assigned another use to the recti muscles, *viz.* to retract the eye-ball into the orbit when the eyelids are closed*; but they have no such power, nor is there any occasion for such an action, for the eye-ball is no more protruded when the eye-lids are open, than when they are shut. The cause of this deceptive appearance will be explained hereafter.

Superior and Inferior Oblique Muscles.—The two oblique muscles are purely involuntary or reflective, and are always antagonists to one another. The action of the inferior oblique is to turn the cornea *upwards* and *inwards*; the action of the superior being to turn the cornea *downwards* and *inwards*. It will be now necessary to prove, that these muscles are involuntary in their action. If there be the slightest irritation produced on the lower part of the eye-ball, the cornea is at once seen to turn upwards by the action of the inferior oblique, and to be retained in that position, in opposition to the will, as long as the irritation is kept up. That it is the action of the inferior oblique, which thus

* It is furnished with muscles capable of moving it towards any side, and of protruding or sinking it." *Physiology of Man; by R. B. Todd.*—Part 3d, page 15.

elevates the cornea, is proved by the fact that it is turned upwards nearly altogether out of view—a power which the superior rectus has not ; for if a person wills to look up, he can do so but cannot turn the cornea out of view. If the superior rectus of any animal be cut, it will be at once seen, that the voluntary power of looking up is lost ; but let the same eye be irritated, and the cornea will be found to turn upwards out of view, as much so as though the superior rectus were uninjured. Then let the inferior oblique of another animal be cut, and the superior rectus left uninjured, and, no matter how much the eye is irritated, the involuntary power of turning up the cornea is lost.

But the question will naturally arise. What is the great benefit to be derived from these involuntary movements of the eye, and would not the voluntary motions answer all purposes? No! The involuntary motions of the eye are (as it has been already stated) altogether for its protection, or nearly so ; a use which the voluntary muscles do not possess. If danger threatens the eye, the cornea turns upwards for its protection, by the action of the inferior oblique, at the same time that the orbicularis closes the lids. Sir. C. Bell supposed another benefit to be derived from this action, viz. that it stretched the lachrymal ducts like a nipple, and thus produced a greater quantity of tears to lubricate the cornea, and wash off any offending matter that might have adhered to it, causing irritation. When it is remembered where the lachrymal ducts open, it will be at once obvious that the above statement and inference are correct.

The inferior oblique always acts consentaneously with the orbicularis palpebrarum, for at the very moment that the orbicularis acts in closing the eye-lid, the inferior oblique turns upwards the cornea almost entirely within the orbit ; and thus proves a protection to the retina, for it darkens the eye, and prevents the light, which in passing through

the lids becomes red, from reaching the retina, upon which the continuous action of the red ray is always hurtful.

The orbicularis palpebrarum thus acting at the same time, the effect is to carry any simple foreign body that may have got under the eyelids, and produce those actions, into the internal canthus, where it is protruded from the eye by the caruncula lachrymalis and semi-lunar membrane.

The direct action of the superior oblique is to turn the cornea downwards and *inwards*; its anatomy will show that this *must* be the result of its action. That it is involuntary, is evident from the fact, that no exercise of the will can produce the same effect. It has been stated that the inferior oblique acts in unison with the orbicularis palpebrarum, for when the orbicularis closes the lids, the inferior oblique turns the cornea upwards and inwards. The superior oblique acts consentaneously with the levator palpebræ superioris; for when the levator raises the upper lid, the superior oblique turns the cornea downwards and slightly inwards. This action, with that of the inferior oblique, takes place every time the eye is shut and opened, as in winking, but the actions are so very rapid as not to be observable. But if a person awaking out of sleep, be watched (when there is no will exercised,) it will be seen, that the moment the levator raises the upper lid, the superior oblique turns downwards the *cornea*, which thus *depresses* the lower lid, so that the superior oblique muscle is the true but negative depressor of the lower lid; this is a novel statement, but of which conclusive evidence will be presently adduced.

Previously to the views set forth by Sir C. Bell, anatomists and physiologists, perceiving that in opening the eyes the lower lid is depressed, sought, but in vain, for a depressor for it. He looked for a direct muscular depressor, and thought that he had found it in the levator palpebræ superioris, which

he said not only raised the upper, but depressed the lower lid. The following are his words (page 153, third edition of his work on the nervous system :)—“The muscle, elevator palpebræ superioris, opens wide the eyelids, depressing the lower eyelid, at the same time that it elevates the upper one. If we put the finger upon the lower eyelid, so as to feel the eyeball when the eye is shut, and then open the eye, we shall feel that during this action the eyeball is pushed outwards. Now, the lower lid is so adapted as to slip off the convex surface of the ball in this action, and to be depressed, whilst the upper eyelid is elevated.” He then gives a plate of the eye and levator muscle, shewing that the muscle, from its origin to its insertion, is in contact with half the circumference of the globe; and infers the above conclusion to be the result of its contraction; evidently having forgotten at the time, that the levator was not in such close contact with the globe of the eye as he stated—the superior rectus muscle lying between them, so that the contraction of the levator could not produce the effect he alleged. He was wrong in supposing the eye-ball to be *protruded* at all. If the finger be placed on the lid, as he recommends, it would appear as though the eye-ball were protruded; and certainly the lower lid *is* depressed, but not by the agent to which he ascribes it: it is effected in this way,—The globe of the eye is composed of the segments of two spheres of different diameters, of which the cornea is the segment of the less sphere; in consequence of which the antero-posterior diameter of the globe is much its larger diameter. Hence it follows, that when the orbicularis closes the eyelids, and the consentaneous contraction of the inferior oblique takes place, by which the cornea is upturned, the situation previously occupied by the cornea, which is filled by the rising of the lower eyelid, due partly to the elasticity of its structure, and partly to the contraction of the lower orbicular fibres. But

when the eyelids open, these fibres of the orbicularis being relaxed, the cornea pushes the lower eyelid outwards and downwards to its original place ; and as this is effected by the superior oblique, acting consentaneously with the levator palpebræ superioris, my position is maintained, that the superior oblique is the muscle whose action is the real cause of the depression of the lower eyelid. (Under ordinary circumstances, when we look at any thing in the line of the cheek bones, the rectus inferior, by still further depressing the cornea, becomes in a similar manner the voluntary depressor of the lower eye-lid.) That this is the case is easily proved ; thus, hold the upper and lower lids of a person close to the edges of the orbit, so as not to allow any voluntary effort of the orbicularis to close the lids, then let him make the effort, when it will be found that the cornea will turn upwards and inwards under the orbit. Then let the person relax the fibres of the orbicularis and bring the levator palpebræ muscle into action, when the cornea will at once turn downwards and outwards by the action of the superior oblique, and in so doing bring the cornea against the lower lid, and depress it. My attention was first drawn to this fact by observing a man, who presented himself at the Eye and Ear Institution with ectropium of both lids of one eye. I directed him to shut his eyes, knowing that he could not do it. When he made the effort, up went the cornea out of my view, so that the man was in complete darkness, and fully under the conviction that he had both his eyes shut ; and when I asked him to open them, the above detailed action of the superior oblique was shown, by the cornea turning downwards and inwards, and then instantly assuming the ordinary appearance of the eye when regarding an object.

Again, let a person close both eyes, and put a finger upon one, so as to feel the eye-ball through the lids, then let the other eye be opened, when it will be found that the

cornea of the closed eye will come down and press against the lower lid upon which the finger is. It may be asked, how is the cornea turned down when the eye-lid is closed, if, as has been already stated, the superior oblique acts in unison with the levator? The answer is, in the same way that the inferior oblique acts, when the orbicularis cannot close the eye-lids. It does act, but is prevented from raising the lid by artificial means. Another answer is, as has been already explained, viz:—that the eyes act consentaneously, so that one eye cannot be kept motionless while the other is in action, even though the former should be blind.

Levator Palpebræ Superioris.—This is a compound muscle, acting both voluntarily and by reflex stimuli, its use being to raise the upper eye-lid upwards and backwards, and to expose the ball of the eye, by which it is made to appear protruded. It is an antagonist to the orbicularis palpebrarum; and, as has been already stated, it acts in unison with the superior oblique. Its reflex action takes place during the rapid motions of winking. During sleep this muscle is relaxed.

Orbicularis Palpebrarum.—This is also a compound muscle of the same order as the preceding, and its antagonist. With it we close the eye-lid, its superior fibres drawing down the upper lid, and its inferior fibres drawing the lower lid upwards and inwards. It also, by its reflex action, endeavours to expel, and usually with success, any foreign body which may get under the eye-lid, by directing it towards the internal canthus. This reflex action is sometimes so great (blepharospasmus) as to defy every effort of both the surgeon and patient to get the lids opened. Indeed, this effort of nature to remove foreign bodies from the eye, sometimes acts, very injuriously: for instance, should the offending matter be a particle of glass, the action of the orbicularis can only make the glass penetrate more deeply into the part with which it is in contact. When danger

threatens the eye, the rapid reflex action of this muscle protects it by closing the lids. That the orbicularis acts consentaneously with the inferior oblique has been already explained. During sleep, the orbicularis muscle, like all others of its class, is relaxed; therefore the eye is not shut in sleep by the action of the orbicularis palpebrarum, but by the relaxation of the levator palpebræ superioris, suffering the upper eye-lid to drop down into its natural position over the globe of the eye; consequently the upper eye-lid covers more of the eye in this state than when the lids are closed by the action of the orbicularis palpebrarum, as in the latter case, the lower lid is always drawn a little upwards.

A strong proof that the eye is closed during sleep by the relaxation of the levator palpebræ, and not by any sphincter properties of the orbicularis, is derived from the pathological fact, that a person with paralysis of the portio dura nerve, cannot, when awake, close the eye-lids by any voluntary action; although the lids are perfectly closed; *i. e.*, the upper lid is perfectly relaxed, during sleep.

Tensor Tarsi.—The use of this muscle is to draw the puncta towards the nose, and to compress the lachrymal sac, and force out the secretion from the follicles of the caruncula. It is thought to act independently of, as well as in conjunction with, the orbicularis palpebrarum.

I cannot conclude the physiology of the muscles of the eye without mentioning a use that has been assigned to the orbicularis; it is an error, and the more dangerous because it rests on the authority of Sir C. Bell, an authority which one hesitates to dispute. He attributed to the orbicularis palpebrarum the power of pushing the eye-ball back into the socket when the lids are closed, and asserted, that it, with the oblique muscles, kept the eye in its place, and prevented it from protruding. This mistake will not be wondered at, when it is remembered that he attributed the power of protruding the eye to the levator. He was

well aware, that no muscle in the orbit had the power of retracting the eye-ball; consequently, he was forced to devise some means of pushing it back; so he invoked the aid of the orbicularis to perform that office, and thought he was right, in consequence of perceiving the eye to be flatter when the lids were closed, than when they were open. But this appearance has been already accounted for by the fact, that, when the lids are shut, the long diameter of the eye is turned upwards. That the orbicularis has nothing to do in keeping the eye from protruding, is easily seen, by raising both lids with the finger from off the globe, when it will be found that the eye does not protrude in the slightest degree; whereas, if it were kept pressed back by the orbicularis palpebrarum, of course the ball would protrude when the pressure by the lids was removed. In addition, we have the further support of the pathological fact, that the eye-ball does not protrude in paralysis of the orbicularis palpebrarum.

Nerves of the Eye, Palpebræ, and Orbit.—Sir C. Bell by unwearied and enthusiastic exertions, in dissection of dead bodies, experiments on living animals, and by pathological reasoning, proved that the body is supplied by two classes of nerves, viz:—sensitive and motor. He also showed that impressions borne to the sensorium are conveyed through the medium of the former, and that the different motions of the body, in obedience to the will, are effected through the latter. But it must be borne in mind, that the motor nerves also act independently of, as well as in obedience to, the will, sympathising with one another through the medium of the sensorium; thus, if a person be pricked with a needle, or any sharp instrument causing pain, he would at once start, so that, at the same moment, both classes of nerves are brought into play, the sensitive nerves bearing to the sensorium the impression of an injury received, to remove which, the sensorium issues its mandate through the motor

nerves, which causes the person to recoil from the injury, either in obedience to, or independently of, the will. To prove that there was no direct sympathy between these two classes of nerves, Sir C. Bell divided the motor nerve, and thereby produced paralysis of the part which it supplied ; still the sense of feeling remained, although there was no power in the part to resist or escape from injury.

Pathology fully sustains the correctness of this theory ; we every day see cases, where there is such disease of some part of the nervous system, that there will be sensation in a part, and no power of motion, or the power of motion, and no sense of feeling. But the necessity for an indirect communication between these two classes of nerves is at once evident ; for it would be of but little use for us to know that we had the power to remove our hand or foot out of a fire that was consuming it, if we had not the sense of feeling, to communicate to us that such an injury was taking place, and *vice versa*.

There are two other classes of nerves, quite distinct from those already considered, viz.—nerves of sense, and the sympathetic ; of the former are the nerves of sight, hearing, smelling, and tasting. These possess neither volition, nor sensation, nor are they in any degree under the influence of the will.

As some of the nerves of the eye have connection with the sympathetic, and as the lenticular ganglion belongs to the sympathetic or ganglionic system, I do not consider it will be much out of place here to give an outline of that system.

The sympathetic nerves are two in number, each descending from the base of the cranium along either side of the spine and terminating in a small ganglion on the coccyx. In their course they form cervical, dorsal, and lumbar ganglia. The superior extremity of each nerve is connected by numerous filaments to several of

the cerebral nerves, some of which have been improperly termed the origin of the sympathetic. In their course along the spinal column they regularly communicate with every pair of the spinal nerves ; with each of the cervical by one filament, and with each of the dorsal, lumbar, and sacral, by two.

The sympathetic nerves may be considered either as an independent part of the nervous system, communicating by numerous branches, with every part of that system ; or each may be regarded as a nervous cord, formed by the union of branches from all the spinal, and several of the cerebral nerves.

The ganglia are small nervous centres, which have been designated diminutive brains. They are of a very irregular shape, but generally speaking, they are round ; each ganglion transmits nerves upwards and downwards to the ganglia which are nearest, and other nerves to the cerebral and spinal nerves.

The sympathetic or ganglionic department, presides over the human economy, with powers altogether independent of the will. It has two important uses to fulfill, viz :—to supply parts, such as the brain, heart; &c., with nervous influence ; and keep up an involuntary sympathy between all the different nerves, with which it has any communication.

Optic Nerve.—The optic nerve is a simple nerve of sense, having but one office to perform, viz :—the bearing to the sensorium the impression of the external objects that are pictured on the retina.

Motores Oculorum, or Third Pair of Nerves.—The third pair of nerves are compound motor nerves, being both in obedience to, and independent of, the will. This nerve gives motion to five muscles of the eye, viz :—the levator palpebræ, superior rectus, inferior rectus, internal rectus, and inferior oblique. The filament to this last is the

involuntary branch of the third, and it is the branch which gives a twig to the lenticular ganglion.

Sir C. Bell, with many other physiologists, considered the third nerve to be completely under the influence of the will; but if such were the case, how could the inferior oblique, which is supplied by it, be an involuntary muscle? that it is such has been already demonstrated. But that Sir C. Bell should suppose this nerve to be altogether under the influence of the will, is not much to be wondered at, as it does not appear that he was even aware, that it gave a twig to the lenticular ganglion. For he said it was given to no other parts but muscles, whereas its communication with the lenticular ganglion is the only possible way to account for the great sympathy that exists between the involuntary action of the inferior obliques and the fifth pair of nerves; and that there is in reality a great sympathy between them, will be shewn when the physiology of the fifth pair of nerves is given.

Trochleator, or Fourth Nerve.—The fourth is a simple involuntary motor nerve, giving motion to the only muscle which it supplies, viz :—the superior oblique. Sir C. Bell attributed to it all the involuntary motions of the eye; but if such were the case all the involuntary motions of the eye would be performed by the superior oblique, although Sir C. Bell himself was well aware, that the inferior oblique was an involuntary muscle. But one error generally leads to many; he was not, it would appear, cognizant of the fact that the fourth received a branch from the fifth nerve. That it does has already been mentioned when describing its anatomy.

Fifth pair of Nerves, (more particularly the Ophthalmic Nerve.)—The fifth is a most important nerve; it possesses many properties, but more particularly, that of sensation. It gives feeling to all the parts to which it is distributed,

the head, face, and skin covering them ; the eyes, nose, tongue, mouth, &c.,

Pathology proves that this nerve is also a nutritive nerve, for if it be paralysed the parts which are supplied by it become emaciated ; and if the part be mucous membrane, its natural secretion ceases, and the parts ulcerate. Indeed the parts supplied by this nerve are dependent upon it for all their healthy actions, more particularly the eye ; for instance, if this nerve be in an unhealthy state, absorption cannot be excited, except by restoring the nerve to its normal state. (This subject is fully explained in the chapter which treats of cataract, opacities of the cornea, &c.) It is to Sir C. Bell that we are indebted for the knowledge that this is a nerve of sensation. If it be injured, either by disease or accident, at the spot where it escapes from the cranium, the result is, that one side of the face loses its sense of touch ; so that the parts may be cut, but the patient does not feel it, although the power of motion is retained.

The ophthalmic division of the fifth, separates into three branches, viz :—the lachrymal, frontal, and nasal. The lachrymal gives a branch to communicate with the superior maxillary, and another to the facial ; it supplies the lachrymal gland, and conjunctiva lining the superior palpebra. The frontal supplies the corrugator supercillii, orbicularis palpebrarum, and occipito-frontalis muscles, and the integuments of the forehead and superior eye-lid ; it also communicates with the *infra-trochlear* branch of the nasal

The nasal or third division of the ophthalmic, before entering the orbit, receives a branch from the sympathetic ; and after it has entered the orbit, it gives off a branch to the lenticular ganglion ; and as it passes over the optic nerve it contributes the two ciliary nerves to the ciliary ligament and iris. It then gives off another branch, which is connected with the supra-trochlear, and is distributed

to the lachrymal passages, and also to the integuments and muscles on the side and dorsum of the nose. The proper nasal branch is distributed, and gives sensation, to the septum of the nose; another branch is lost in the integuments on the tip of the nose, to which it gives sensation.

The inferior palpebra is supplied by the terminating branch of the second division of the fifth, which also gives a branch to communicate with the nasal nerve on the side of the nose.

From the different connections of this nerve we can easily understand the sympathy that should exist between the conjunctiva and the inferior oblique muscle. The inferior oblique derives its motor nerve from the inferior oblique branch of the third, which also gives a branch to the lenticular ganglion, and this ganglion receives a twig from the nasal branch of the fifth, which nerve imparts sensation to the conjunctiva.

The connection of the fifth nerve is more direct with the superior oblique muscle, whose motor nerve being the fourth, receives a branch directly from the fifth. It is the sensitive properties of the ophthalmic branch of the fifth nerve which occasions the profuse lachrymation, redness of the conjunctiva, and sneezing, when the nose is stimulated by any irritating substance. That this effect is caused through the fifth, is evident, from the pathological fact, that, if the fifth be paralysed, although odours are perceived by the first or olfactory nerve, still no tickling or irritation of the nose will produce sneezing; indeed the person so afflicted does not even feel the irritation.

Among the many offices of the ophthalmic branch of the fifth, I believe it be the protector nerve of the eye; and here I conceive the following very important question arises, viz.:—

Does it protect the eye in any other way, than by discovering bodies when in contact with that organ, and thus

exciting its involuntary motions, for the purpose of rejecting the foreign body?

I hold that it does, and my views will be explained presently. There is an involuntary motion of the eye for its protection, independent of the fifth nerve, which is the action produced by sight; danger is seen to approach the eye before it touches it, and as soon as received, by the sensorium, it issues its mandate through the portio dura (which is the motor nerve of all the muscles of the face) to the orbicularis palpebrarum, which immediately closes the lids to ward off the approaching danger. But when notice of danger is conveyed by contact upon the eye or lashes, the muscle will contract in precisely the same way, the impression having being borne to the sensorium by the fifth, and the reflex action accomplished through the portio dura.

I shall now endeavour to explain in what manner I believe the fifth to be a further protection to the eye, in addition to the modes just detailed. I hold that the ophthalmic branch of the fifth pair of nerves preserves the retina from more light than it is able to receive without injury; and this is caused by this branch being sensitive to the stimulus of light, independently of the retina. This is a novel statement, but I think I can sustain it by facts. If such be not the case, how, I would ask, can we account for contraction and dilatation of the pupil in persons who are totally blind, whether owing to paralysis of the optic nerve or retina? If the iris were dependent for its action upon the reflex stimulus from the retina, this could not be the case; for the amaurotic retina, it must be remembered, is incapable of discerning even the very strongest light.

An objection that may be started against this theory is, that in the majority of cases of amaurosis, the iris is motionless and the pupil fixed. Such, truly, is the case, but we must call to mind the many different causes which produce

amaurosis. The cause may be injury or derangement of the fifth nerve itself, or even of the third. How often do we see this caused by wounds on the eye-brow, eye-lid, or forehead. Supposing the cause to be paralysis of the optic nerve or retina, what is there more likely, than that the same disease should also frequently cause derangement of the lenticular ganglion, or of either the third or fifth nerve, or both? Again why does light give pain in conjunctivitis, or such excruciating agony in strumous ophthalmia? The retina surely can have nothing to do with it. But it has been said, the contraction of the pupil gives the pain, because, that when the application of belladonna dilates the pupil, the patient is relieved. I certainly cannot understand how contraction of the pupil can give pain; I am rather inclined to think that it is the pain which causes the contraction of the pupil; and that in the use of the belladonna its application removes the morbid irritability of the fifth pair of nerves, and the pain being relieved the pupil dilates. This can be proved as follows: In strumous ophthalmia, instead of using belladonna, let the irritability of the fifth be removed by the application of nitrate of silver to its external branches, in the integuments of the superior palpebræ; after which it will be found that when the pain has been assuaged, the pupil will be dilated: now, certainly the nitrate of silver has no specific power over the iris; it can therefore only dilate the pupil indirectly, that is, by relieving the pain of the fifth nerve.

That pain causes the pupil to contract is evident from the fact. That in couching for cataract, the pupil having been previously well dilated with belladonna, no sooner does the operator commence to pierce the coats of the eye, than the pupil begins to close, and before the operation is completed, he finds it much more contracted than he desires. But how is the pupil contracted by the stimulus of light; The answer is, that the iris receives sensation from the ophthalmic branch

of the fifth, and motion from the involuntary branch of the third; branches of those two nerves, form the lenticular ganglion, which in turn supplies the iris with nervous power in addition to that furnished by the two branches given off from the nasal branch of the fifth. Hence it is clear, that the iris is supplied with both a sensitive and an involuntary motor nerve, that the stimulus of light on the iris is borne to the sensorium through the fifth nerve, and that the sensorium issues its commands through the third, which causes the involuntary action of the pupil, thus it is that the iris is found to possess all the properties of an involuntary muscle, supplied with a sensitive and an involuntary motor nerve.

The iris acts as a curtain between the cornea and the posterior chamber of the eye, suffering no rays of light to pass but what enter through the pupil, and then only so many as are necessary to perfect vision, which is another great proof of its sensibility to light, independently of the retina; and fortunately such is the case, for, were it otherwise, the retina would often suffer from the shocks of light it would receive. If the retina received the impression before the iris acted, a most important use of the iris and the pupil would be wanting.

According to my theory of the sensibility of the iris to the stimulus of light through the fifth pair of nerves, it can be well understood, that the iris acts as a safeguard to the retina, by instantaneously adjusting the size of the pupil to the intensity of light, and allowing only the proper amount of light to pass through. This end it always accomplishes, except when its mobility is temporarily impaired by a long exposure to great light or profound darkness, and the opposite state is suddenly assumed.

I also hold (contrary to the received opinion of physiologists in general,) that belladonna possesses no power over the retina. I know the question may be asked, does not

belladonna possess a specific power over the retina, and its use produce temporary amaurosis? The use of belladonna does produce temporary amaurosis, but not by any direct influence it may have upon the retina, but on the fifth pair of nerves, causing the pupil to become so dilated as to admit a greater number of rays of light upon the retina than it is prepared to receive; for as soon as the pupil contracts the amaurosis is removed. Another proof of this being a correct theory, is an experiment I made at the request of Doctor S. C. Sewell, to whom I first communicated my opinion upon this subject; after smearing the palpebræ of a patient with extract of belladonna, which dilated the pupil, and produced temporary amaurosis, I took a pill box and made a small aperture in the bottom of it, I then held it to the patient's eye, so close as to exclude all light from the eye except what passed through the aperture, or artificial pupil, in the bottom of the box. The patient told me when she looked through the aperture, that she could see things nearly as well as before I put the black stuff on her eye, but that when I removed the box, her vision became confused. This I have since tried with many other patients, and always with the *same* result; and finding the trial so successful, it, of course, strengthened my opinion that the effect produced on the eye by belladonna is through its action on the fifth pair of nerves, it being at once evident that if its action were upon the retina, looking through the aperture in the pill box could not improve the sight in the slightest degree.

I would further cite, in corroboration, the temporarily improved vision occasionally effected in cataract by dilating the pupil with belladonna.

Sixth or Abducens Nerve.—The sixth nerve, which supplies the external rectus muscle and receives a branch from the great sympathetic, is a simple motor nerve, and acts in obedience to the will.

It was my intention to have given the physiology of the *lenticular ganglion*, and *ciliary nerves* separately, but during this chapter I found it necessary to combine their physiology with the *third* and *fifth* pairs. They are referred to again in the physiology of the globe of the eye.

Lachrymal Organs.—The lachrymal gland secretes the tears which lubricate the front of the eye, and wash away offending matter. The ducts conduct the tears from the gland, and pour them over the eye. The puncta take up the tears, and any mucus that may be secreted on the eye, and carry them through the ducts into the lachrymal sac, from whence the whole is conducted into the nose, through the nasal duct.

Conjunctiva.—One use of the conjunctiva is, as its name implies, to bring the palpebra and globe of the eye into intimate contact; it thus affords free motion to the eye-ball, and prevents any foreign body from entering the orbit. Its second use is to secrete a peculiar fluid, which lubricates itself, thus making its motions over itself smooth and free. Its semi-lunar fold is something like the haw or second eyelid in the quadruped; it, in connection with the caruncula, helps to protrude foreign bodies from the eye when such bodies are lodged in the inner canthus. The conjunctiva possesses great sensibility, which is caused by its being so liberally supplied by the ophthalmic branch of the fifth pair of nerves. It is a mucous membrane.

Meibomian Glands.—The use of these glands is to secrete a thin sebaceous fluid, for lubricating the eye.

Ciliae.—The use of the ciliae is to act as a shade for protecting the eye.

Eye-brows.—The use of the eye-brow is also to protect the eye, particularly by preventing any moisture, such as perspiration coming off the forehead, from getting into it; the eye-brow being so formed as to direct the course of the moisture outside the external canthus of the eye, down the cheek.

CHAPTER IV.

OPTICS, AND PHYSIOLOGY OF THE EYE.

PREVIOUSLY to giving the physiology of the globe of the eye, I feel that it is necessary to say something on the subject of optics, an acquaintance with which is advantageous to every one, while it is actually necessary to all who desire to understand how the eye receives the impression of external objects. I shall commence the subject by the following very beautiful extract from the *Encyclopædia Britannica*:—"Optics, from the Greek word *optomai*, to see, is the name given to that branch of natural philosophy which treats of the nature and properties of light; of the changes which it suffers either in its qualities or in its course when transmitted through bodies, when reflected from their surfaces, or when passing near them; of the structure of the eye and the laws of vision; and of the construction of those instruments in which light is the chief agent.

"The ancients confounded the phenomena of vision, with those of light, by supposing that when we see external objects, something passes from the eye to the object. The phenomena of light, however, are totally independent of those of vision, and have a real existence in nature; whether we suppose them to be objects of vision or not.

"Light is the element by means of which we see external bodies. These bodies may be divided, in reference to light, into two classes, *self-luminous* and *non-luminous* or dark bodies. The first class includes the *sun*, the *stars*, flames of all kinds, and bodies which become luminous by friction, heat, electrical and magnetical action. Such bodies become visible by the light which they themselves emit; and we

then obtain a knowledge of their apparent form. The sun, for example, is seen to be round, and the flame of a candle to be a conical shape. The second class of bodies, however, are never visible but when placed in the light of self-luminous bodies ; it includes the moon and all the primary and secondary planets, upon which the sun's light directly falls, and all the other objects upon our globe.

“ When we bring a lighted candle into a room, its light falls upon all the objects in the apartment, and they become visible wherever we place our eye. But objects also become visible by the light thrown off by non-luminous bodies. When the moon has the form of a sharp crescent we see the obscure part of its circular disc by the light thrown upon the earth, which is at that time almost fully illuminated by the sun. In like manner in the room lighted with a candle, objects are seen in corners and places upon which the light of the candle does not fall ; Those objects, however, are illuminated by the light of the candle thrown back by the white ceiling and walls of the apartment ; and hence the reason why the ceilings and walls of apartments should always be white, if we wish to attain the greatest quantity of light from a given flame. The light thrown off from all bodies, whether self-luminous, or non-luminous, is of the same colour of themselves ; a red hot body, or a stick of red sealing wax will make a sheet of white paper appear red, if held near them.

“ But though coloured bodies throw off light of the same colour of themselves, bodies do not appear of the same colour as that light, which falls upon them ; all bodies which are white in white light, appear of the same colour as that of the light which falls upon them ; but other bodies, such as red wax, appear red even in white light, a property which they have from a peculiar structure acting upon the different colours of which white light is composed.

“Bodies of this kind, when illuminated with lights of different colours, always appear brightest in light of the same colour which they exhibit. Thus a stick of yellow wax is more luminous than a stick of red wax, but the yellow wax will be less luminous than the red if we illuminate them both with red light. Bodies in their relation to light are divided into two classes, opaque and transparent. An opaque body is one that stops the light that falls upon it, such as a piece of coal, or a plate of silver; and a transparent body is one which transmits the light through it, such as glass, water, and air. The most opaque body, however, may be made transparent by making it sufficiently thin, and the most transparent one may become opaque by making it sufficiently thick. The opacity of bodies, or their power of intercepting light, gives rise to what is called the shadows of bodies. As the shadows of bodies are of the same size as the bodies, we thence deduce the fundamental optical fact, that light moves in a straight line. The same fact may be proved in a thousand ways, but most simply by placing three small holes in a straight line. In this case the light will pass through them, but if any one of them deviates from the straight line the light will be stopped. The same thing is finely seen without any experiment, by admitting light into a dark room through an aperture of an inch wide, its path, marked out by the floating dust which it illuminates, will be seen to be a straight line. Light issues or radiates in every direction, and from every point in the surface of luminous and visible bodies. This fact is proved by the circumstance, that we see such bodies wherever we place our eye. However much we may magnify the bright part of the sun’s disk through a microscope, we shall never see any point destitute of light.

“Light consists of separate and independent parts, which when reduced to the smallest magnitude, are called rays

of light. A beam of light transmitted into a dark room may be actually divided into smaller portions in a variety of ways. The smallest portion that we can allow to pass may be called a ray of light, and possesses the same properties as the large beam.

“Light moves at the rate of 192,000 miles in a second. This extraordinary property of light has been deduced by direct calculation from the immersions and emersions in eclipses of Jupiter’s satellites, which become visible to us nearly a quarter of an hour earlier when the earth is nearest Jupiter than when it is farthest from that planet. The exact velocity of light, obtained in this manner, is 192,500 miles in a second; whereas Docter Brinkely and Mr. Strure have found it to be 191,515 miles in a second, from the phenomena of aberration. This last determination is undoubtedly the most correct. The mean, however, of 192,000, is most easily remembered.

“The velocity with which light travels is so inconceivable, that we require to make it intelligible by some illustrations. It moves from the sun to the earth in seven and a half minutes, whereas a cannon ball fired from the earth, would require seventeen years to reach the sun. Light moves through a space equal to the circumference of the earth, or about 25,000 miles, in about the eighth part of a second. The swiftest bird would require three weeks to perform this journey. Light would demonstrably require five years to move from the nearest fixed star to the earth, and probably many thousand years from the most remote star seen by the telescope; hence, if a remote star had been created at the time of the creation of man, it may not yet have been visible to our system.

“When light falls upon any body, whether rough or smooth, coloured or uncoloured, a part of the incident light enters the body, and is either lost within it, or transmitted through it; and part of it is reflected from its sur-

face, either in the same or in a different direction from that in which it come. The light which enters the body and is lost, the light which is transmitted through the body, and the light which is reflected from it, suffer certain changes in their direction, and in their physical properties. It belongs to the geometrical or mathematical part of optics, to assign the laws which regulate the change of direction which light experiences when it is transmitted through, or reflected from, bodies whose density is uniform, and whose surfaces have a geometrical form; and to physical optics, to explain the changes in the physical properties which light acquires in passing through bodies, in passing near them, or in being reflected from their surfaces.

“The laws or rules which regulate the reflection of light, constitute that branch of optics which is called *catoptrics*, and the laws which regulate the changes of deviation which light experiences when transmitted through bodies, is called *dioptrics*.”

DIOPTRICS.—(From *optomai*, to see, and *dia*, through.)—When a ray of light passing in a straight line is interrupted by falling upon a drop of water, or a piece of glass, or a bottle containing any fluid which allows the light to pass it, the ray will not reach the eye, or illuminate a piece of paper placed behind these bodies, in the same way as before any of these bodies were placed in the way of the ray. This arises from the direction of the light being changed by some power which resides in the bodies. The branch of optics which explains the law by which the direction of light is changed, is called *dioptrics*. That this may be the better understood, let it be presumed that the following diagram, marked M, N, O, P, is a vessel, having in its side N, O, a small hole at N.

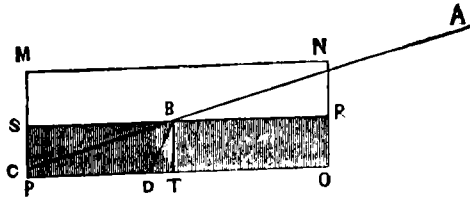

If a lighted candle is placed at A about two feet from the vessel, a ray of light A N, proceeding from it, will pass through the hole N, and go on in a straight line A N C, to the bottom of the vessel at C. If a mark is put at the point C, and water be then poured into the vessel till it rises to the height S R, it will be found that the round spot of light which was at C, will then be at D that is, the ray, A N, which went straight on to C when vessel was empty, will be bent at the point B where it falls upon the water, into the line B D. If there is a slight mistiness given to the water, by mixing in it a little milk or soap, the ray B D will be distinctly perceived, and it will be seen that it is a straight line, and that the bending, or change in its direction, has been produced wholly at the point B, and on the surface of the water. This bending of the ray A N B, is called refraction, or breaking back from its course at B, and the water is said to refract or break back the ray A B. Salt water refracts more than fresh, alcohol more than either, and oil more than any of them, and glass would refract still more than oil. If a peice of glass was cut into the exact shape of the water S R O P, and placed in the vessel instead of the water, it would refract the line B D, to B T; hence the general conclusion that when a ray of light passing through air falls in a slanting direction upon the surface of liquid, or of solid bodies through which light can pass, it is refracted by them, and by different bodies in different degrees.

The substance generally used for refracting rays of light, both in optical experiments and optical instruments, is glass, and for this purpose it is shaped into solids of different forms, as the following :

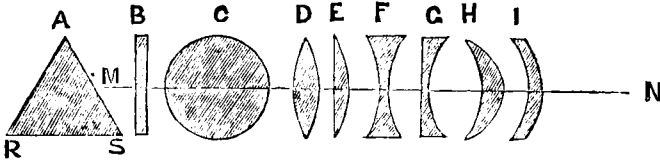

The first of these figures is a prism which is a solid, having two plane surfaces $A R$, $A S$, inclined to one-another. The second figure B is a plane glass having two plane surfaces parallel to each other. The third figure C is a sphere having every point of its surface equally distant from a common centre. The fourth figure D is a double convex lens, which is bounded by two convex spherical surfaces whose centres are on opposite sides of the lens. It is equally convex when the radii of both surfaces (that is, the distance from the centres to the circumferences of the circles they belong to) are equal; and unequally convex, when these radii, or distances are unequal. The fifth figure, represented at E , is a plane convex lens, bounded on one side by a plane surface, and on the other by a convex. The sixth figure F is a double concave lens, bounded by two concave spherical surfaces whose centres are on opposite sides of the lens. The seventh figure G is a plane concave lens, bounded by a plane surface on one side, and a concave surface on the other. The eighth figure H is a meniscus, bounded by a concave and a convex spherical surface, the two surfaces meeting if continued. Ninth figure I is a concave convex lens, bounded by a concave and a convex surface, but these two surfaces do not meet although continued.

The axes of these lenses are a straight line $M N$, in which are situated the centres of their spherical surfaces, and to

which their plane surfaces are perpendicular. To describe how all these different lenses refract the rays of light which fall upon them would be doing more than would be compatible with the design of this work ; however, the manner in which those lenses which are connected with the physiology of the eye refract, will be explained.

DOUBLE CONVEX LENS.

The action of an equally double convex lens in refracting the rays of light, is similar to that of a sphere, the only difference being that the two surfaces are brought nearer to each other ; in consequence of which the ray refracted by the first surface, falls upon the second surface at a different point, and at a different angle, the effect of which is to produce a change in the position of the focus.

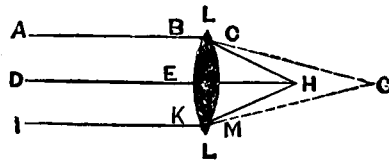

Let L L be a double and equally convex lens of glass, a line D H passing through the centre, F the middle point of its greatest thickness, which is called its axis. Let parallel rays, A B, I K, fall upon the first surface at the points B K, these will be refracted in the direction B C, K M. Had there been no second surface, these rays would have converged at a focus G, but as they meet the second surface of the lens at C and M, they will then be refracted so as to take the directions C H, M H, and have their principal focus at H ; if parallel rays should fall obliquely upon a double convex lens, there will be a focus formed in like manner but not in the axis G. For example :

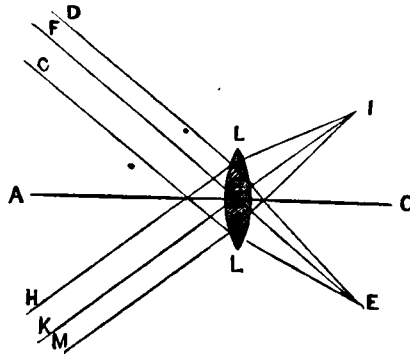

Let $L L$ be a double and equally convex lens of glass, its axis $A B C$, it will be found that parallel rays $D L$, $F B$, $G L$, and $M L$, $K B$, $H L$, falling obliquely on the lens will have their foci at the same distance behind the lens at I and E . For these and all other cases the rays $F B$, $A B$, $K B$, which pass through the centre B , will be found to proceed to $I G$ and E , without changing their direction. Now in what manner the operation of a double convex lens forms the image of any body in an inverted position, upon a surface situated at the opposite side of the lens, can be easily understood. If, for example, there be a lighted candle held with its flame at $D F G$, and the candlestick which holds it at $H K M$, ($L L$, being a double convex lens) and a sheet of paper be held as a curtain at $I C E$, according to the law just laid down the flame of the candle will be pictured on the paper at E , and the candlestick at I , both of them inverted. But as the candlestick is not a luminous body its picture will not be visible.

This can be exhibited by holding a double convex lens, between the flame of a candle and a sheet of white paper, at such a distance as to bring the light to a focus on the paper; the picture of the flame will be distinctly seen on the paper, its position there being inverted.

DOUBLE CONCAVE LENS.

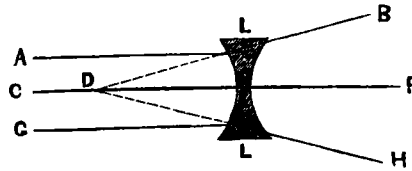

Let $L L$ be a double concave lens whose axis is $C D F$, and E its middle point, if parallel rays, $A L$, $G L$, fall upon it, they will be found refracted in the directions $L B$, $L H$, so diverged as if they proceeded from D , a point before the lens which is the principal focus of the lens.

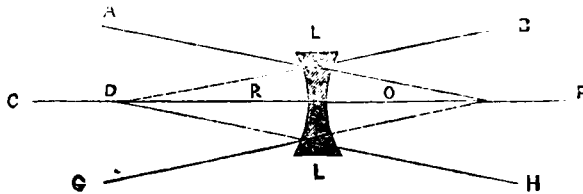

When converging rays proceeding to a point F , beyond the principal focus O , of a concave lens, are intercepted by it, they will be made to diverge in lines $L B$, $L H$, as if they proceeded from a focus D , in front of the lens beyond R . When F coincides with O , the refracted rays $L B$, $L H$, will be parallel, and when the point F is within O , the refracted rays will converge to a focus on the same side of the lens with F , but on the other side of O , these foci, F and D , are called congregative foci.

The effect of a *meniscus* upon light is the same as that a convex lens of the same focal distance. And that of a concavo-convex lens, of is the same focal distance.

Sun-light.—Sir Isaac Newton proved that the light from the sun was white, and that it was made up of seven different colors, viz :—red, orange, yellow, green, blue, indigo, and violet. These colors often appear by themselves, and

the white light from which they are produced is decomposed or separated into its elements by different processes.

That branch of optics which treats of the colors of light, of their physical properties, and of the laws according to which white light is decomposed and recomposed from the elements, is called *chromatics*.

Rays of light of different colors have different degrees of refraction, or, as it is expressed, different refragibilities. The method by which Sir Isaac Newton established this fact was as follows. In the window-shutter, E G, of a darkened

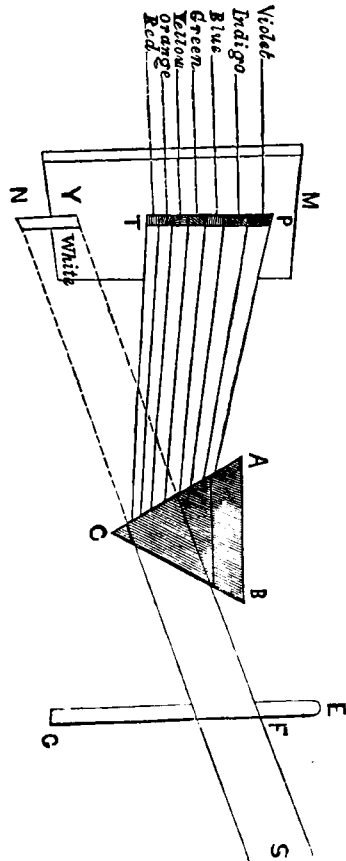

room, he made a hole F, about one third of an inch broad, behind which he placed a glass prism, A B C, so that the beam of the sun's light, S F, might enter and leave the prism at equal angles. Before the interposition of the prism, the beam S F, proceeded in a straight line to Y where it formed a round white spot, but when refracted by the prism it formed upon the screen M N, an oblong image P T, containing seven colors as enumerated in the figure, the red being least, and the violet most refracted, from the original direction S Y, of the solar beam. This oblong image P T, is called the solar and sometimes the prismatic spectrum. By making a hole in the screen M N, opposite any one of these colours, so as to allow it alone to pass, and by letting the color thus separated fall upon a second prism he found that the light of each of the colors was alike refrangible, because the second prism could not separate them into an oblong image, or into any other color. Hence he called all the seven colors simple or homogeneous, in opposition to white light, which he called compound or heterogeneous.

Having thus decomposed light into seven primary colors, he shewed that these seven colors, when again put together or combined, recomposed white light, which was done by the removal of the prism.

That these colors mixed together make white, can be proved in a rude way by mixing together seven different powders in due relative proportions, having the colors and properties indicated above; the mixture will be a sort of greyish white, because the colors employed cannot possibly be obtained of the proper tints.

Having entered more deeply into the science than I originally intended, I shall now consider that part of optics which relates particularly to the eye. The eye is that organ which makes us sensible to the rays of light. It consists of two parts, viz:—the organ of sense, (the retina,) which receives the impression, and the

optical parts, by which the rays of light are made capable of forming an impression upon it.

The first principle in the constitution of the eye, is, that the rays of light must be so concentrated as to impinge strongly on the retina. To produce this effect, there is in the eye a double convex lens (and it has been already shewn that a double convex lens concentrates the rays of light proceeding from an object, so as to form a lively image of the object at its focus, when the focus falls upon a sheet of paper or any other curtain,) therefore rays of light passing through the cornea, falling upon the lens, will be by it converged to a focus upon the retina, and there form the image of the object from whence the rays of light proceed. But that this effect may be perfect, *all* the optical part of the eye must be perfect also. Firstly, the cornea must be perfectly transparent, having a proper convexity and forming a large segment of a small sphere, (thereby taking a greater circumference into the sphere of vision than could be done if the large sphere of the eye-ball had been continued on the fore-part of the eye) so that the greater number of rays of light will be received upon it, which rays passing through *it* and the *aqueous humour*, are refracted till they fall upon the lens. The aqueous humour must be clear, and of a sufficient quantity; if not clear it will refract the rays of light too much; if too great in quantity it will make the cornea too convex; if too little the cornea will not be sufficiently convex; if dense, and not perfectly fluid, it will also prevent the free motions of the iris. The iris must be perfect, and allow no rays of light to pass it, except those that enter through and are collected by the pupil, which rays must strike directly upon the lens situated behind it. The next part of the eye that is necessary for perfect vision, is the crystalline lens, which should be at a proper focal distance from the retina, or the object will be formed either behind or before the retina. It is also necessary that the perfect shape of the

eye should be preserved, therefore the vitreous humour must be perfect in quantity, and on it also depends the lens being kept at a proper focal distance from the retina; the *quality* and consistence of the vitreous humour must be perfect also. While each of the humours of the eye have distinct characters, they also in proportion to their density, possess different degrees of power in refracting the rays of light entering them, it being a law in optics that rays of light, when they pass from one medium into another of greater density are refracted and the greater the density of the second medium, the greater the degree of refraction; consequently, as the cornea and humours of the human eye are more dense than atmospheric air, (the medium through which the rays of light come to the eye) the rays of light, thus entering the cornea and humours of the eye, must be refracted. But rays of light entering the cornea of fishes, will be refracted in a less degree, because the medium from whence the rays reach the eye (namely water) is of the same density as the aqueous humour, and this evil effect is counteracted by the cornea of the fish being very flat. Therefore the more equal the density of both media, the less will be the refraction. In this way it is easily understood why persons, when they open their eyes under water, see objects so imperfectly. It will now be considered what is that state of the eye which produces short-sightedness (*MYOPIA*.)

There are many causes in the formation of the eye which conspire to produce this effect, which cannot come under the name of disease:—*Firstly*, If the cornea be too prominent, whether it be from too great a quantity of aqueous humour or otherwise; *Secondly*, Should the lens have too great a degree of convexity; *Thirdly*, Should there be too great a quantity of the vitreous humour, making the antero-posterior diameter of the eye greater than it should be; And *Fourthly*, Should any of the humours not be perfectly transparent. But this

latter state is generally the result of disease. In any of these cases, sight must be imperfect, because the powers of the humours in concentrating the rays of light are too great, consequently the image of the object is not formed on the retina but before it. The short sightedness of youth is indeed generally the result of the cause first mentioned, viz :— too great a convexity of the cornea ; which evil is counteracted by the use of spectacles with double concave glasses, the effect of such glasses being to cause the rays of light to fall upon the surface of the eye at an angle so far diverging from the perpendicular, as to adjust the degree of convergence caused by the too great convexity of the cornea. If the cause be too great a *quantity*, or too great a *convexity* of any of the humours, the use of a double concave glass will be of equal benefit. To short-sighted persons, on their bringing an object sufficiently near to see it distinctly, the object appears as large as it would to persons whose sight is not defective, if they looked at it with a magnifying glass. Such persons always see a distant object indistinctly, and if it should be of a pointed shape, or a shining nature, it will always appear double. How this occurs is well explained in the following quotation from the work of Sir C. Bell : “ The horns of the new moon, or the top of a distant spire, or the lines upon the face of a clock, appear double or triple, and sometimes much more multiplied to a short-sighted person. The same appearance will be given when an object is held too near the eye for perfect vision. If light is seen through a narrow split in a board, and the board is brought nearer to the eye than the point of distinct vision, the aperture will appear as *two* luminous lines, with a dark line between them ; and as the distance is varied, two, three, or four dark luminous lines will be observed. To explain this, Sir Isaac Newton taught that ‘ in the progress of rays of light, there is an alteration, by fits of easy transition or refraction, or in other words that there is a change of disposition in

the rays to be either transmitted by a refraction or to be refracted by the surface of a transparent medium.” To explain how this occurs, Sir C. Bell gives a diagram of the eye, shewing that when direct rays strike on the convex surface of the cornea, part of them are reflected laterally, and those transmitted strike on the surface of the lens in luminous rings, which are multiplied and diminished in diameter, on being in part *transmitted* and in part *reflected* from the surface of the lens and vitreous humour. These effects of the alternate disposition of the rays, for transmission and reflection, would not be perceptible, did the converging powers of the cornea and lens bring the focus of the rays exactly to the surface of the retina; but as the focus is formed before the retina, the rays decussate and spread out again before they form the image upon the retina; instead, therefore, of forming an accurate image, they are spread out into concentric circles, and the person experiences a confused outline of the object, which becomes surrounded with several rings or false outlines. The reader must remember that Sir C. Bell speaks in such a case, of a person short-sighted from too great a convexity of the cornea.

The following is a note of Sir C. Bell's:—“By fits of easy transition, it was not meant by Sir Isaac Newton that the rays must necessarily be transmitted through every pellucid medium, and at any obliquity of incidence, but only that the rays were more easily transmitted and with more difficulty reflected; nor was it meant that during its fit of easy reflection, the ray was absolutely incapable of being transmitted, but only more readily reflected than transmitted.”

It is worthy of remark that short-sighted persons, when looking at distant objects, always frown or knit their eyebrows, so as partially to close the eye-lids; the reason is obvious; the cilia change the direction of the rays, and thus correct the inaccuracy of the image, as if the person

were looking through a concave glass, or through a small circular hole. To make the above statement more clear, it is necessary to mention, that when a stream of light passing from an object to the eye, passes through a circular hole, the margin of the hole attracts the rays of light and causes them to take a direction outwards as if proceeding from a nearer object ; so that the image is removed further back from the lens and nearer to the retina.

Many have stated that myopic persons as they grow old lose their near-sightedness, from the decrease of the humours and the consequent lessened convexity of the cornea ; I have never met with any such decided case, but certainly as they get old they do not become long-sighted, like the majority of old people who have had unimpaired or non-defective sight in youth.

Presbyopia.—Presbyopia is the very opposite of *myopia*,—it is long-sightedness, and is caused by the cornea not being sufficiently convex, (from any cause,) in which case the rays of light are not sufficiently refracted so as to cause them to converge to a focus on the retina, but as it were some distance behind it. This is generally the result of old age, the humours decreasing at that time. The consequence of the defect is counteracted by the person wearing spectacles having a double convex lens, which will so correct the rays of light as to make the image fall accurately on the retina.

When we look at an object, as it approaches the eye, the diameter of its picture on the retina increases ; and as the distance between the object and the eye augments, the picture on the retina diminishes ; but the degree of brightness of the picture continues the same at all distances, except some of the rays of light coming from the object are intercepted in their course ; therefore remote objects sometimes appear dim in consequence of the opacity of the atmosphere. It will be remembered that in describing the action of a double convex lens, it was stated that if the lens were held

between the flame of a candle and a sheet of white paper, on which the light had been brought to a proper focus, the flame would be seen on the paper in an inverted position; now the very same effect is produced in the eye, for every object we look at, and see, is pictured on the retina in an inverted position; although they appear to us, as they are in nature,—*erect*.

To understand this it is necessary to know that the eye sees no part of itself, neither does it see the picture upon the retina, the picture being only the instrument by which the object is seen: hence the comparing and judging of the object are dependent upon the mind, the impression of the picture having been first borne to the cerebrum through the medium of the optic nerve. This is evident, for if the optic nerve be deranged, vision is lost, although the eye performs all its functions, refracting the rays of light, and forming a lively picture of the object upon the retina. The best explanation that can be given of images inverted on the retina is that given by Reid:—"Every point of an object is seen in the direction of a right line passing from the picture of that point on the retina, through the centre of the eye, to the object point; and therefore such points indicate to the mind the existence of the object point, and its true situation; and of course that the object whose picture is lowest on the retina must be seen in the highest direction from the eye; and that object whose picture is on the right of the retina must be seen on the left; so that by a natural law of our constitution we see objects erect by inverted images, and if the picture had been erect on the retina we should have seen it inverted."—(*Reid on the Human Mind*.)

The next thing to be considered is, What are the changes the eye undergoes, so as to adapt itself to distant objects after we have been for some time looking at near ones; and *vice versâ*? That there is some change can be easily perceived, because if we turn from a near to look at a distant

object, or from a distant to observe a near object, it takes some little time for the eye to adapt itself to the second object, so as to see it distinctly. Numerous have been the theories propounded on this question, some thinking that a sudden change occurs in the convexity of the cornea,—others, that this change takes place in the convexity of the lens, or from some movement of it; and others would have it that it is caused by the impression of the first object remaining after the eye has been removed from it.

To me these theories, one and all, seem purely imaginary; indeed it has never been stated how the two first changes could take place, until Mr. Porterfield described what he terms the ciliary muscle, and though I do not like to doubt its existence, I by no means consider its action proved, although he is supported in his views by so strong an advocate as Mr. Todd, whose description of the ciliary muscle will be found on p. 24 of this work. The following quotation from Mr. Todd's valuable work (Part 3, p. 47) will shew his views upon the uses of this muscle:—

“This leads to the consideration of one of the most admirable provisions for the extended utility of the organ; viz:—its capacity of adaptation, under the influence of the will, to distinct vision at every distance beyond that of a few inches. We have the power of producing some change in the eye by which its focal length is modified to suit the varying angle at which rays from surrounding objects fall upon it. Many different explanations have been attempted of the mode in which this adaptation is effected, of which may be mentioned that of Jurin, Ramsden, and Home, that the cornea undergoes a change in its curvature, becoming more convex for near objects;—and that of Des Cartes, Albinus, Hunter, and Dr. Young, who considered the lens muscular, and to possess within itself the power of changing its curvature. Others, again, ascribe this power of

adaptation to the iris, the motions of which might, as Knox supposed, alter the curvature of the lens ; or, according to Sir David Brewster, cause the lens to change its place and come forward during contraction of the pupil ; a change in the position of the lens has also been supposed to occur from contractions in the ciliary processes or zonula, and many have contended that the entire eye-ball may alter its relative dimensions by the action of its muscles. It is conceivable that any of these changes, could they be proved actually to take place, might be sufficient to account for the effect ; but in estimating their relative value, the greatest importance is to be attached to the anatomical evidence by which they may be supported. In the eye of the bird, the ciliary muscle, from its position and attachments, must necessarily approximate the lens to the cornea ; and the reasons for considering the same part muscular in mammalia, and if so, for ascribing to it the same function as in birds, have been already mentioned, and appear to us conclusive. We therefore, on anatomical grounds alone, adopt this view, ably advocated by Porterfield, conceiving that when the eye is intent on near objects, the ciliary muscle is contracted, the lens advanced towards the cornea, and the latter membrane, perhaps, rendered more convex by the traction of the muscle on its borders, by means of the cordage of the posterior elastic lamina ; while in vision of remote objects the lens is carried back towards the retina by the elasticity of the neighbouring parts. It is interesting to notice that this adjusting faculty of the eye is greatly impaired or altogether lost by extraction of the lens, or by paralyzing the ciliary and iridal muscles by belladonna." Now I by no means consider these arguments conclusive, for I see no attempt made to *prove* that the lens is drawn backwards towards the retina by the elasticity of the neighbouring part, while the eye is engaged examining remote objects ; and it is actually necessary to prove this, to make it con-

clusive that the lens is drawn forward when the eye is engaged examining near objects. It appears to me that the changes are altogether dependent upon the contraction and dilatation of the pupil; for the more distant and obscure the object is, the more the pupil is *dilated* and the closer and more distinct, the more the pupil is *contracted*. Why this change takes place is easily understood, when it is remembered that the iris is sensible to the stimulus of light, and, being so, the pupil contracts or dilates according to the strength of the rays upon it (whether they be direct or reflected,) and the nearer the object is, the stronger will be the rays thrown upon the eye.

All visible bodies, except luminous ones which are seen by their own rays, or transparent bodies situated between us and luminous ones (and thus visible by the rays which they transmit) are seen by the reflected rays from that actual body, whose rays picture it upon the retina, no matter how *large* or *small*, or of what color it may be, and the nearer the object the stronger will be the rays reflected from it upon the eye. Therefore, when we look at a distant object, the pupil is dilated, but when we regard the same object at a less distance, the pupil becomes contracted: if it did not, the rays proceeding from the object would so diverge as not to unite in corresponding points upon the retina. Therefore, I think it is quite evident that the change the eye undergoes to adapt itself to a second object, after being previously engaged observing another, is either dilation or contraction of the pupil, and the quicker the pupil acts in either case, the quicker the second object is seen. A similar effect is produced when a person goes from a room greatly illuminated into the dark, or from the dark into an illuminated room; in either case it takes some time for the person to discover objects clearly, in fact not till the pupil has had time to conform itself to the sudden change. The next thing to be considered is how the eye sees every object in

its own proper color. From what has been already said, the reason is quite obvious. Each body reflects rays of its own colour, and is seen by its own reflected rays, as has been already explained; if it be a luminous one it gives out rays of its own color, and if transparent, *transmits* rays of its own color; it therefore follows that the design pictured upon the retina must be of the same color as the object. I shall next consider the physiology of the different parts of the eye separately.

Tunica Sclerotica.—The sclerotic coat, from its tensity, and elastic nature, is well adapted to preserve the shape of the eye, and to be a protection to its internal parts, either from external pressure or from the violence one part would do to another internally, by the displacement which would occur if there were no external case or regular pressure to keep them in their own place. Another use of this tunic is, that by its fibrous texture it is well suited for the insertion of muscles to move the eye-ball. Thirdly, it is well adapted for the transmitting of vessels and nerves to and from the internal parts of the eye. Fourthly, by its opacity it renders the eye a dark chamber, and it permits no rays of light to pierce it.

Choroid Coat.—This, the vascular coat of the eye, is a secreting membrane, and like all others of that class divisible into laminæ. It secretes that peculiar fluid called pigmentum nigrum, which is a black mucous substance, situated between the choroid coat and the retina, and so enveloped round the latter membrane as to absorb any rays of light that may fall upon it; from its color *it* also darkens the chamber of the eye. The external lamina of the choroid appears to be solely for the purpose of protecting the vessels and nerves, or of supporting them in a proper position.

Ciliary Processes.—The use of these processes, which are formed by the choroid coat, appears to me to be for the purpose of conducting vessels to the lens.

Retina.—The use of the retina is to receive the impression of external objects, and although insensible to touch, the smallest ray of light will make an impression upon it. All parts of the retina are more or less sensible to the impression of external objects, except that part perforated by the optic nerve, where in reality there is no retina at all, for it is only there the optic nerve spreads out into the retina; of course the porus opticus, or black spot in the centre of the optic nerve, cannot receive the impression of light, as it is only an artery.* But the punctum aureum, or spot of Soemmering, being in the very axis of vision, would lead us to suppose that that particular spot is more sensible to the impression of external objects than any other part of the retina; we are strengthened in this view by the fact, that if by any accident the axis of vision is changed, as occurs in *strabismus* or *lucitas*, the sight is not so perfect. It is very difficult to say what it is that gives this spot its peculiar color; some have considered that it is owing to some peculiarity of its organization; others, that it is a perforation or deficiency of the retina. I am free to acknowledge I cannot satisfy myself as to the actual cause, but I think there may be an absence of the lamina vasculosa in that spot, and thus the nervous coat or true retina is exposed. There is one thing certain, that there can be no absence of the true retina for if such were the case the consequence would be blindness,—this spot being in the axis of

* "It appears, by a simple experiment, for the principle of which we are indebted to Mr. Mariotte, that the small portion of the retina corresponding to the entrance of the optic nerve, is incapable of exciting visual sensation, though it receive the image of an object. Place the thumbs together at arm's length, shut the left eye, and fix the right eye steadily on the left thumb; then the right thumb, if moved gradually outwards (so that its image on the retina of course traverses inwards) ceases to be visible in a particular spot, but is again seen beyond it. It will be remembered that the fibrous lamina of the grey nervous layer of the retina is here evolving itself from the nerve, and is not yet invested with the vesicular or other laminae: a circumstance of great interest in regard to the *modus operandi* of the constituents of the retina in vision."—*Physiology of Man*, by R. B. Todd—Part 3, page 54.

vision. The vascular coat of the retina not only supplies the retina with arteries, but also the hyaloid membrane and the capsule of the lens.

Cornea.—The cornea, from its great transparency, and being situated in the front of the eye, forms the window of that organ, and owing to its convexity, is well adapted for the reception of rays of light; from an extended periphery; by its tensility and elasticity it protects the internal parts of the eye, and from its laminated structure and vascularity, it is well fitted to bear the injuries and diseases to which it is exposed. That the cornea is largely supplied with nerves, is abundantly proved by its great sensibility when diseased, and, as has been already stated in page 21, they can actually be demonstrated. That it is freely permeated with blood vessels, is shewn by the rapid progress with which ulcers or wounds will heal when properly treated; and it is an acknowledged fact that parts badly supplied with blood vessels heal with much difficulty. A further proof of its vascularity is that a blow on the eye will often cause effusion of blood between the layers of the cornea, and the fact of the coagulum being absorbed, shews conclusively that it is supplied by absorbents.

Aqueous Humour and its Tunic.—The tunic of the aqueous humour is both a secreting and absorbing membrane; it secretes the aqueous humour, as often as it is lost by accident, and absorbs an hydropium, blood, or even the lens when it is broken up. The use of the aqueous humour is to keep the cornea full and convex, and by its fluidity to float the iris. It has been already explained how its tunic and the cornea refract the rays of light passing through them.*

*In the London Medical Gazette for January 4, 1850, there is recorded by Dr. France, a case of congenital deficiency of the aqueous humour. The child was a year old, eyes bright and clear, cornea more convex than usual but not conical, iris in juxtaposition with the posterior surface of the cornea, but not

Iris.—So much has been said of the use of the iris, when giving the physiology of the ophthalmic branch of the fifth pair of nerves, and of sight, that there remains little more to be said on this subject. It serves as an opaque curtain between the cornea and retina, allowing no rays of light to reach the latter, but what pass through the pupil, and afterwards strike on the lens before falling on the retina. The uvea, which covers its posterior part, assists in making it opaque. It is this chiefly that gives the color to the iris, the iris being either light or dark according to its own transparency. The more transparent the iris is the darker it is, for the black uvea shews more plainly through it, and consequently the thicker and stronger the iris, the lighter will be its color; and this accounts for the delicacy of the black iris compared to the gray, and how much worse it bears disease; it also explains why dark-eyed persons are generally more weak-sighted than those who have light eyes. It is true that this theory would be more clear if all eyes were either black or gray; for how, it may be asked, are blue and brown eyes to be accounted for? I answer that it is still owing to the color of the uvea: but as to why the uvea differs in color in different persons is one of those difficulties upon which I have no hypothesis to offer, and which, as far as I am aware of, no physiologist has suggested a reasonable solution.

But it may be said if this theory is true, removing the uvea will remove the color from the iris. Well so it does in a great degree but not altogether, nor should such be expected in as much as the substance of the iris itself becomes colored by absorption or some other process that I will not attempt to explain. The iris, by its

adherent to it, action of the pupil regular, sight good but slightly myopic, Mr. France considered that the lens existed and was in juxta position with the posterior surface of the iris. He did not however examine the eye catoptrically, owing to the patient being a child, and consequently could not be got to keep steady.

attachment to the ciliary processes transmits nerves to the lens, it also possesses all the properties of an involuntary muscle, being supplied with an involuntary motor branch from the third nerve, and a sensitive branch from the fifth, through the lenticular ganglion and ciliary nerves.

Capsule of the Lens.—This capsule keeps the lens in its place and secretes the liquor Morgagni; it also converges the rays of light which it transmits.

Lens.—The use of the lens has been already explained when giving the physiology of the eye generally. That it is not indispensable to vision is evident, as it is often removed in the operation for cataract, without producing any material injury to vision. It is supplied with blood vessels from the ciliary processes, and with nerves from the posterior edge of the iris attached to the ciliary processes. The vessels cannot be injected or traced in the adult, but they can in the fœtus.

Vitreous Humour.—The use of the vitreous humour is to give shape and fulness to the eye, and to keep the lens at a proper distance from the retina. It also helps to converge the rays of light.

Hyaloid Membrane.—The use of this membrane is to preserve the shape of the vitreous humour, and probably to secrete it.

Having finished the anatomy and physiology of the eye and its appendages, it only remains to add, that all these parts are liable to inflammation and all its consequences. They are also subject to various morbid changes.

PART SECOND.

CHAPTER V.

PATHOLOGY OF THE EYE.

IN this division of the work, the author has endeavoured to demonstrate, in as simple a manner as possible, all the diseases and injuries, with their consequences, to which the eye and its appendages are exposed; and as a thorough knowledge of the first part is actually necessary for the reader before he can understand the second, it is proposed to assist his memory by treating of those injuries and diseases as nearly as possible in the order in which the anatomy has been given.

INJURIES OF THE ORBIT.

Contusion of its edges.—The edge of the orbit, from its exposed situation, is very liable to be contused by blows and falls;—adults chiefly suffer from the former, and children from the latter mode of injury. If a child receives such an injury, providing its constitution be good, the affection will generally terminate very favourably, and without any bad symptoms. But should the child be of a scrofulous diathesis, or the constitution be otherwise bad, it is likely to end in suppuration, affecting in time the periosteum and bones. Blows on the edge of the orbit sometimes cause concussion of the brain, or inflammation of its membranes, or substance, or even effusion of blood within the cranium. These various effects depend, of course, altogether upon the greater violence of the blow which has been dealt upon the part presenting the contusion, which now

becomes of secondary importance. While, therefore the surgeon's attention is drawn to the direct injury of the bone, or the soft parts which invest it, he must watch closely for any head symptoms that may present themselves, as their appearance is sometimes very sudden, and the fatal consequences equally rapid. Contusions of the temporal angle of the orbit have been sometimes followed by the growth of tumours within the orbit.

Should a blow causing a contusion of the edge of the orbit also occasion a wound, that is a breach of the integuments, the termination of such an injury is generally worse than if there was only a simple contusion, for very frequently it produces erysipelatous inflammation, which too often ends in death. This complication, however, depends much upon the state of the patient's general constitution.

Treatment.—The only treatment that is found necessary in simple contusions of the edge of the orbit, is cold applications of the acetate of lead, rest, and perhaps a gentle saline laxative.

Fractures of the Edge of the Orbit.—Blows on the edge of the orbit sometimes cause fractures of it. When such is the case and there is not much swelling of the soft parts, the Surgeon can easily feel the loose portion of bone.

Treatment.—If the bone be displaced, it should be replaced in its natural position, which is sometimes very difficult to do, and it is even more difficult to provide mechanical means to keep it in its position. The best mechanical means I have found, is a piece of white leather well smeared and softened in either starch or the white of an egg. This leather should be stuck upon the part, and when it has become dry, it forms a good splint; should moist applications be required to the surrounding parts, the leather may be covered with oil silk.*

*Since the above was written, the ethereal solution of gun cotton has been introduced as an adhesive material, and far exceeds all others, particularly in not being acted on at all by water, and its instantaneous stiffening.

Compound Fractures of the Edge of the Orbit.—Sometimes a portion of the fractured bone will penetrate through the skin, or there will be a wound through the integuments, forming a communication between the bone and the atmospheric air. The broken piece will sometimes penetrate into the frontal or maxillary sinus, or into the æthmoidal cells. The consequences of such an occurrence are these: In a child, when it cries, or in an adult, when he blows his nose, the air will be found to pass through the fracture into the cellular membrane of the eye-lids, causing them suddenly to swell up.

Treatment.—If the fracture is compound, the surgeon should at once endeavour to make it simple, by healing the external wound. If he fails in this, he generally finds portions of the bone come away by suppuration, and more or less deformity will be the natural consequence. When any of the cavities are opened, and air is effused into the cellular tissue, Mr. Mackenzie recommends the air to be liberated by puncturing the part with a lancet. This is, however, not a practice that I can recommend. I have always found that cold applications, with properly directed pressure, will produce all the effects required.

Incised and Punctured Wounds of the Edge of the Orbit.—These wounds very constantly produce fracture, but this, of course, depends upon the force causing the wound. The inflammation that follows such wounds is generally very acute, and the pain very severe. And although their appearance may seem very simple, they almost invariably (in children) produce convulsions and death. They even cause death in the adult, by the inflammation becoming *erysipelalous*, and spreading to the membranes of the brain.

Treatment.—The surgeon must endeavour to prevent the bad effects above mentioned. If it be a simple incised wound, it should be healed by the first intention. If a punctured wound, suppuration should be encouraged by

warm poultices, and the wound brought to heal by granulation. The surgeon should always make sure to remove any foreign body that may be in the wound; rest and quietness must be rigidly enforced.

Gun-shot Wounds of the Edge of the Orbit.—When the edge of the orbit is wounded by a gun-shot, if it be a ball, it generally carries away the part; but if it be only by small-shot, they more generally lacerate, without much loss of substance.

Treatment.—Remove any foreign body that may be in the wound; should the bone be broken and detached, it is not to be quickly removed, as the bones of the face are sometimes found to unite, although they may be perfectly shattered, but after suppuration sets in, if any loose splinter should be found acting as a foreign body, the sooner it is removed the better. As much of the wound as possible should be healed by the first intention; the rest of it must be left to the second intention. If the shot is lodged in the wound, it should be carefully removed, if at all practicable.

Any wound of the edge of the orbit may injure the ophthalmic branch of the fifth pair of nerves, and thereby produce amaurosis. A direct consequence may be inflammation of the brain, or its membranes,—and secondarily, deformity.

General Prognosis in Injuries of the Edge of the Orbit.—From what has been already said the reader must perceive, how cautious the surgeon should be in giving his *prognosis*. Should the contusion be slight, and the patient possess a good constitution, there is but little to be dreaded; but should the patient be a child of an unsound constitution, it may terminate very badly, no matter how simple the injury may appear at first sight.

Fractures generally unite well, and wounds heal favorably. The brain is most likely to suffer if the upper edge of

the orbit is the part injured. Punctured wounds must always be regarded as dangerous.

General Treatment.—*1st.* As a general rule, if there be no external wound, one should not be made; *2d.* If there are any foreign bodies present, remove them; *3rd.* Unite all the wound that is possible, by the first intention; *4th.* Preserve the parts as much as possible in their original position; *5th.* Avoid promoting suppuration, except in the case of punctured wounds; *6th.* Until bones are dead and acting as foreign bodies, they should not be removed; *7th.* The best local application consists in cold saturnine lotions, but should the cold be uncomfortable the applications should be made warm; *8th.* During the healing process of the wounds, any risk of deformity should be guarded against, by the surgeon's dressing and watching the case himself, instead of leaving it to be done by ignorant or inexperienced persons; *9th.* Should head symptoms set in, general and local bleeding, with purging and general antiphlogistic measures, should be adopted.

CHAPTER VI.

FRACTURES AND INJURIES OF THE WALLS OF THE ORBIT.

Fractures of any of the walls of the orbit frequently extend to the skull; indeed if the roof of the orbit is fractured, it constitutes a lesion of the cranium. Any of the walls may be fractured by a blow of a heavy blunt instrument, but this accident is almost always caused by a gun-shot, or by a sharp-pointed instrument thrust into the eye, such as a *foil* or a sharp-pointed stick. When such is the case, the fracture becomes a compound one; cases have occurred in which a ball has traversed both orbits posteriorly to the eye, and in its course divided the optic nerves, without producing death; army surgeons see many cases of fractured walls of the orbit from sabre cuts. As already stated, these fractures frequently extend into the skull, frontal, maxillary, or sphenoidal sinuses; and very often there is merely a crack or fissure which can only be discovered after death.

In penetrating wounds causing fracture of the walls of the orbit, it may happen that the instrument remains buried in the part, and is not only hard to discover but even difficult to remove. Fractures of the external or inferior wall are not so dangerous as those situated in the roof or internal wall, for they are not in such immediate connection with the brain. Where the missile sticks in the orbit, the eye-ball generally protrudes, but such may occur without the instrument remaining. In these cases, the trifling appearance of the external wound very often deceives the surgeon.

The effect produced by such injuries may be either immediate or remote. The immediate effects are *hemorrhage, extravasation of blood, blindness, strabismus, syncope, vomiting, coma, convulsions, paralysis*, and not uncommonly *death*.

The remote effects are, *fever, delirium, suppuration, caries, exfoliation of the bone, &c., &c.*

Prognosis.—The surgeon must be guided in his prognosis by the situation more than the extent of the injury, for should the roof or external wall be the seat of the injury, although the wound may be small, the prognosis is more unfavorable than if a greater wound existed in the external wall or floor. If the symptoms lead the surgeon to suppose that the brain, or its tunics, are injured, the prognosis will be still more unfavorable; and to the last degree so, if a foreign body be lodged in the brain itself, although producing no *immediate* bad symptoms: for he must remember that it may cause death, either by being left there too long, or, on the contrary, by its removal. Another circumstance necessary for the surgeon to remember, is, that although at times the slightest puncture of the brain may cause immediate death, still disorganisation of a portion of it may proceed slowly, and yet life be prolonged for years. Why this should happen, cannot be satisfactorily explained, but that such is the case, there exists ample proof.

The injury the blood vessels have received, and the quantity of blood effused, will also guide the surgeon in his prognosis.

Treatment.—The treatment in these cases will very much depend upon the extent of the injury received. The injured part should be carefully examined, and every foreign body removed, even a piece of bone, if it is found acting as such. Probing the wound should be avoided as much as possible; uniting the external wound by the first intention is reprehensible, as it prevents free egress to the discharge of pus, which always forms in the internal parts.

The surgeon should endeavor, without using unnecessary force, to replace the parts in their natural position.

The best local applications are emollient cataplasms, and soft light dressings, such as lint wet in tepid water, and covered with oil-silk. The dressings must be frequently removed, and the wound kept perfectly clean, and occasionally examined, lest any piece of exfoliated bone should be keeping up irritation. After the sloughs have been cast off, and when the inflammation is moderated, the surgeon may begin cautiously to draw the wound together.

Cases may be met with where it will be necessary to divide the soft parts, and even trephine the bone, to give exit to extravasated blood, purulent matter, or detached pieces of bone.

The general treatment will depend upon the symptoms that present themselves.

Upon reaction setting in, blood-letting may be required, but it is a remedy that should be employed with great caution, that is, neither too soon, nor too profusely, and occasionally the use of the lancet may be superseded by tartar-emetic in nauseating doses, or the sedative influence of the former may be maintained by the judicious use of the latter medicine ; quiet and rest should be particularly observed ; spare diet, laxatives, and gentle diaphoretics should be given, with an occasional dose of blue-pill or calomel. Sometimes an anodyne may be required to give the patient sleep, and relief from pain.

CHAPTER VII.

DISEASES OF THE ORBIT (PERIOSTITIS, OTITIS CARIES, AND NECROSIS.)

Periostitis.—The bones of the orbit, like all other bones of the body, are liable to disease, but as the periosteum possesses greater vitality, so it is more liable to inflammatory action. Inflammation of this fibrous tissue is more frequently of a chronic than of an acute nature. There are different causes which may produce *ostitis* or *periostitis* of the orbit, such as injuries, cold, syphilis, scrofula, or the spread of inflammation from the surrounding parts. Inflammation of either the periosteum or bone may end in resolution, suppuration, caries, necrosis, hyperostosis or bony node, and finally, it may terminate fatally.

Symptoms.—If the inflammation be acute, there is pain in the temple of the affected side, which extends down to the teeth; great circum-orbital neuralgia, and pain along the course of the fifth nerve, which pain is increased by pressure on the eye. This is followed by nausea, head-ache, irregular attacks of fever, loss of appetite, want of sleep; the eye-lids eventually become swollen, and when the case is to end fatally, delirium and coma supervene.

Morbid Appearances.—A quantity of purulent matter will be found between the periosteum and the bone; the periosteum will be detached and the bone denuded at the seat of the inflammation; the dura-mater will also be detached from the bone, and its surface covered with puriform fluid; the pia-mater will be found unusually vascular, as well as the substance of the brain; serum is sometimes

discovered in the ventricles. If the inflammation has been in the apex of the orbit, pus will generally be found there, which, during life, had caused the protrusion of the eye-ball. In chronic ostitis or periostitis of the orbit, there are four distinct stages:—*1st.* Inflammation; *2nd.* Abscess; *3rd.* Fistulous opening; *4th.* Distortion. In the first stage, the eye-lids are red, hot, painful, and swollen, and sometimes œdematous. In the second stage, a spot on the lid points and bursts, discharging a thin purulent matter; and sometimes the skin becomes extensively ulcerated. In the third stage, the aperture becomes fistulous, surrounded by fungous granulations. If a probe is passed through this fistulous opening, it will come in contact with the bone, which will be found in either a state of caries or necrosis. After long continued suppuration and exfoliation, the fourth stage has taken place, the parts heal, the external aperture closes, and the integuments adhere to the periosteum. A cicatrix is thus formed, accompanied by shortening of the lid (*Lagophthalmos*) with more or less eversion (*Ectropium*).

Such chronic inflammation is generally found in children of a scrofulous diathesis, the usual cause being falls or blows on the outer angle of the orbit. It is accompanied by more or less fever, and a strumous inflammation of the conjunctiva, which produces great intolerance of light; and when the conjunctivitis subsides, it leaves the cornea nebulous. The general causes of secondary inflammation of those parts, are inflammation of the orbital cellular tissue, the lachrymal gland inflaming and running into suppuration, abscess in the orbit not being opened, orbital tumours running into suppuration, and severe inflammation of the eye-ball spreading into the periosteum.

Secondary caries is sometimes found in scrofulous children, particularly in the fossa lachrymalis. When this takes place, the case always terminates in *lagophthalmos* and *ectropium*; caries within the cavity of the orbit is more

frequently found in old than in young people, for which there can be no particular cause assigned. The roof of the orbit is the part most generally affected, but it may occur in any part of it; it always terminates in exfoliation. The deeper in the orbit the disease is, the more dangerous it will be, and it will generally be found to be caused by the cellular substance in the orbit running into suppuration, and from the matter not being evacuated, but kept pent up in the cavity, from whence it finds its way into some of the neighbouring cavities. If it works its way into the cranium, it generally produces death,—if into the frontal, or maxillary sinus, it will escape through either the mouth or nose. Although the purulent matter which effects all this mischief may not be discovered till after death, yet, generally speaking, its formation is accompanied with pain, fever, swelling of the eye-lids, immobility, and distortion of the eye-ball, producing exophthalmia, vision being always injured, and generally destroyed. Syphilis, scrofula, or scorbutica, may be causes of caries of the bones of the orbit, but to know by which it is produced, we are generally dependent upon the history of the case; however, when it is owing to syphilis, the neighbouring bones are generally affected, the pain in general is worse at night, and nodes are likely to be found on the tibia, or on the os frontis.

Prognosis.—As there are different stages of periostitis and osteitis, so according to the progress made by the disease and the condition of the patient's constitution, will be the prognosis. The cause of the inflammation will also be a guide to the surgeon, as also the symptoms, both local and constitutional. There is no case, however simple at first, that something may not occur to cause it to terminate fatally, the knowledge of which fact should always make us very cautious in giving our opinion as to the result. If the case is seen in the first stage, and the patient has a good constitution, a better opinion can be enter-

tained than if suppuration had already commenced. If caries and exfoliation have set in, nothing can prevent more or less deformity ensuing, the extent of which will depend upon the treatment adopted. If, during the first stage, head symptoms set in, it is no reason why a fatal termination should be prognosticated, but should they make their appearance in the second or suppurative stage, then, in all probability, the case will end fatally.

Treatment.—If the disease be seen in the first stage, the object of the surgeon should be to obtain its termination by resolution; and this can only be attained by prompt general and local antiphlogistic treatment. If the patient's habit will bear it, blood should be freely drawn from the arm, but under any circumstances, local bleeding should not be neglected; the application of a number of leeches to the surrounding parts, and particularly to the mastoid process, will produce the best effects. The patient should be well purged by a dose of calomel, followed up by saline purgatives; nausea should also be produced, by the administration of small and repeated doses of tartarised antimony, which will also act diaphoretically. An anodyne at night will often be required, which may be either opium or hyosciamus; the latter is generally found to agree best, not being so likely to produce termination of blood to the head. Rest and quietness are most necessary. Local applications are not of very great utility, still they should not be neglected. I think the best is the solution of the acetate of lead; as to whether it should be cold or warm, the surgeon may be guided by the patient's feelings; let it be applied in whatever way he finds it most comfortable.

If in opposition to the surgeon's best directed efforts, the case runs into the second stage, the moment he is certain that matter is formed, he should, if it be at all practicable, give it free exit. The best place to make the puncture for this purpose is through the reflected portion of the con-

conjunctiva, but very often, from the swollen state of the eye-lids, this proceeding will be found impossible. If the puncture must be made through the lid, it should be as far as possible from its edge, as this will be found the best place to prevent deformity; and if the puncture is to be effected through the upper lid, caution must be taken not to cut the fibres of the levator palpebræ, which might occasion *ptosis*.

When the matter has been evacuated, a small tent of lint should be put into the wound to keep it from healing externally: a warm poultice should then be applied, and the patient made to rest in such a position as to let the matter drain out through the wound. With regard to the general treatment, much will depend upon the origin of the disease, and the patient's constitution. When it is syphilitic, mercury has been recommended, but I much doubt its efficacy in such cases, and would myself prefer prescribing sarsaparilla, with either nitric acid or iodine; if the constitution is tainted with scrofula or scorbutica, alteratives and tonics, such as the iodide of potassium, and the sulphate of quinine will be found the most efficacious. I have reason to have most confidence in the effects of quinine. A generous diet should be enjoined; wine may be necessary, but it should be given with caution.

Should the disease run into the third stage, the surgeon on introducing his probe into the fistulous opening, will find the bone necrosed; his object now must be to hasten the exfoliation of the dead bone, get the parts to heal as quickly as possible by granulation from the bottom, and endeavor by every means in his power to prevent deformity from taking place. Sometimes deformity, such as ectropium, or lagophthalmos ensues; the treatment for these will be found under their proper heading in this treatise.

CHAPTER VIII.

DISEASES OF THE ORBIT,—*continued*.—(PERIOSTOSIS, HYPER-OSTOSIS, EXOSTOSIS, OSTEO-SARCOMA.)

Periostosis.—By the term periostosis is meant a node or thickening of the periosteum, which may occur on any of the bones of the body, but those which have not a deep superficial covering are the bones most frequently affected; consequently this diseased state of bone sometimes occurs on the bones of the orbit, and when it does, it is very difficult to diagnose, and much more difficult to treat successfully.

Causes.—The causes are very obscure; syphilis or scrofula seem to be the chief.

Symptoms.—There is pain in the eye and the side of the head, vision becomes impaired, and the vessels of the conjunctiva tortuous; the patient complains of giddiness, double vision, and sometimes of muscæ volitantes; the eye-lids and eye-brow become swollen and puffy; the eye protrudes, and vision is destroyed. If the cause be syphilis, *iritis* generally accompanies the disease of the bone,—if scrofula be the cause, scrofulous corneitis may be present. Secondary inflammation sometimes attacks the node, producing suppuration, which, if allowed to escape, will be found to be pus mixed with a reddish-coloured serum.

Prognosis.—The prognosis cannot be very favorable under any circumstances; much will depend upon discovering the cause; should amaurosis be produced by the pressure of the tumour, even though the tumour be removed and the

eye restored to its natural position, all the chances are against the sight being ever recovered.

Treatment.—If inflammation be present, leeches should be frequently applied as near as possible to the diseased part; and great relief is often obtained by blistering the temple of the affected side, or behind the ear. If the cause be syphilis, mercury should be given, but not pushed to salivation. If iritis be present, the use of belladonna should not be neglected. If there is any objection to mercury, oil of turpentine may be given with good effect. The best formula is that recommended by Mr. Carmichael of Dublin, for syphilitic iritis, which is as follows;—

℞. Olei Terebinth. Rect. ℥i.
 Ovi vitellum unum,
 tere simul, et adde gradatim,
 Emulsion. amygdal. ℥iv.
 Syrup. cort. aurant. ℥ij.
 Spirit. Lavand. comp. ℥iss.
 Olei. cinnam. gut. iii. M.
 Sumat. Coch. Max. bis vel ter in die.

The formula which I use in dispensary practice is the following:—

℞. Carb. Potass. pur. ℥ss.
 Olei. Terebinth. pur. ℥i.
 Spt. Lavand. Comp. ℥i.
 Ol. Cinnam. gut. vi.
 Aquæ Font. ℥iv. M. Fiat mist.

The carbonate of potass should be first dissolved in the water, then the oil of turpentine added gradually, and lastly the spirit of lavender and the oil of cinnamon. This is a much cheaper mixture, and I have found it to agree just as well with the patient's stomach. Another remedy which may be found useful in such a case, is nitric acid taken internally. As soon as the inflammation has abated, and the

patient's health will bear it, change of air will be found of great benefit.

If the cause be scrofula, after the acute inflammation has been removed, some preparation of iodine should be given, and I know of none better than the ioduretted solution of iodide of potassium, a table-spoonful of which an adult may take three or four times a day, unless it be found to disagree with the stomach*

As a matter of course, if secondary inflammation should have set in, and the node be found to fluctuate, shewing that suppuration has commenced, a puncture should be made, and the matter evacuated; after which the wound should be healed, and every effort made to get the remainder of the tumour removed by absorption.

Hyperostosis.—This is an increase in the thickness of the bone, caused by inflammation having been arrested before disorganisation or death of the bone occurred.

This disease may happen in any bone, but those of the cranium are most liable to it.

When it occurs in the orbit, the cavity becomes small, and its contents being pressed upon, the eye-ball becomes distorted and finally destroyed.

Symptoms.—The disease is slow in its progress. As it advances, it produces inflammation of the eye-ball, which causes great pain in the head and face; as the inflammation increases, so does the pain, so much so as sometimes to produce delirium; finally the eye bursts, and only then does the patient get relief. After this, if the surgeon examines the cavity of the orbit, he will find it quite filled up with osseous deposit.

* Formula 1st.—℞. Hydriod. Potass. ℥i.

Iodini gr. xii.

Aquæ font. ℥viii. M. Fiat mistura.

Second formula—℞. Tinct Iodini,

Liquor. Potassæ aa ℥ii.

Aquæ font. ℥viii, M. Fiat mistura.

Treatment—In this disease, there is not much to be expected from any treatment. The constant application of leeches and warm fomentations is likely to give most relief, and if any medicine could stop the progress of the disease, iodine would most likely succeed. Should the eye-ball be once distorted and vision lost, the patient suffering great pain and delirium, I would not wait for the eye to burst, but evacuate its contents with the knife, and by so doing, exempt the patient from many days of suffering, and perhaps save his life.

Exostosis.—This is an exuberant growth of osseous matter on the surface of a bone, and is a most formidable disease. As to the class of bones that may be affected, Mr. S. Cooper makes the following remarks:—

“The bones most frequently affected with exostosis are those of the cranium, the lower jaw, sternum, humerus, radius, ulna, bones of the carpus, and particularly the femur and tibia.”

“There is however no bone of the body which may not become the seat of the disease. It is not uncommon to find all the bones of the cranium affected with exostosis, and the ossa parietalia sometimes an inch thick.”

Exostoses differ very much in respect to *size, shape, structure,* and *consistence*. They are sometimes small and circumscribed; others are of a conical shape with a broad base; others again are of a styloid figure, projecting in a greater or less degree; some are found to be cellular, formed of a few broad plates or laminæ, intercepting extensive spaces which are filled with matter, to which variety the name of laminated exostosis is given. Another variety is called craggy,—it consists of a mixture of osseous laminæ, with cartilage but no shell, the matter deposited being phosphate of lime very imperfectly organised. As regards the third variety, the matter deposited is pretty perfect bone; the surface of the tumour is sometimes smooth, and often

studded with little projections; its consistence is perfectly solid, exceeding that of the hardest bone, and often equaling that of ivory, which with its appearance, has got for it the name of *ivory exostosis*. Sir A. Cooper found hydatids in an exostosis of the tibia.

Causes.—The causes which produce so formidable a disease are not perfectly understood. It has been imputed to scrofula and syphilis, like every other disease that is imperfectly understood: it has been known to succeed injuries.

Symptoms.—Exostosis occurring in the bones of the orbit, is the same as when it occurs in any of the other bones, but according to the situation of such a tumour will be the severity of the symptoms. The progress of the disease also may be either acute or chronic: but the acute form generally appears in the laminated exostosis. When an exostosis forms within the orbit, the following are generally the symptoms:—*1st.* Pain, which varies much in its situation and severity,—at one time, it is in the eye-ball; again, in the temple, or deep in the orbit, or sometimes the whole course of the fifth nerve is affected. Some persons experience great pain from a very small exostosis, while others do not suffer so much from a much larger one. *2nd.* The eye-ball is protruded to the opposite side from that on which the exostosis grows, and should it be in the bottom of the orbit, the eye will be protruded forwards. *3rd.* Such pressure on the globe of the eye produces amaurosis. *4th.* Should the tumour continue to enlarge, it will press upon some of the neighboring cavities, and if it be on the cranium, it will produce death. The constitutional symptoms are irregularity of the bowels, impaired appetite, broken rest, great debility, and sallow complexion.

Diagnosis.—As the general symptoms which appear in exostosis of the orbit will be found to exist, when the growth of other tumours takes place in that cavity, it is

nearly impossible to diagnose the disease until the tumour be exposed by a section of the soft parts covering it.

Prognosis.—Very little encouragement indeed can the surgeon hold out to his patient. Spontaneous destruction of the tumour may take place from inflammation; but such an occurrence is very uncertain, and if it should happen, very tedious. The ivory exostosis sometimes seems spontaneously to stop growing.

Treatment.—In the treatment of this disease, the object of the surgeon should be to get the tumour, if possible, absorbed, in which, if he fail, he must remove it by operation. To remove it in the first way, the means to be used are both local and general. If the system be tainted with syphilis, mercury must be given, leeches applied to the part, or near it, and friction made over it with the camphorated mercurial ointment. If, on the contrary, the system is tainted with scrofula, alteratives, tonics and iodine, must be given, leeches applied to the part, and change of air recommended. If there be no inflammation, some benefit may be derived from electricity.

Different modes have been recommended for the removal of the tumour by operation, but as to a choice, much depends upon the size and situation of the tumour, and the state of the surrounding soft parts. In the removal of such tumours, it may sometimes be found necessary, first, to include the eye; but a very free opening through the soft parts is always necessary, so that the base of the tumour may be well exposed. When the tumour is denuded of its covering, the following are the different modes recommended for its removal;—a strong sharp scalpel or a bone forceps, saw, or chisel and mallet. Some recommend filing it down with a rasp;—others advise stripping it of its periosteum, and then destroying it by the application of caustic.

If the surgeon must operate, I would recommend the bone forceps, scalpel, or a small circular saw, as the safest instruments.

The after treatment is the same as that recommended in wounds of the orbit; but as a general rule, the surgeon must be guided by the symptoms that arise. Rest and quietness must be particularly enforced.

Osteo-Sarcoma.—This and what Sir A. Cooper called the fungus exostosis of the medullary membrane is one and the same disease. Boyer gives two specimens of this disease, one proceeding from carcinomatous deposit in the neighbouring soft parts; in the second, the disorder commencing in the bone, the soft parts becoming secondarily affected. In this disease, the bony texture disappears, and its place is occupied by a homogeneous mass of a fatty or lard like substance, its color being of a greyish yellow, and its consistence that of cheese. Bone, muscle, tendons, vessels, cellular substance, all are confounded in this diseased mass.

When the disease is not so far advanced, portions of the bone will be met, with its texture nearly natural, but merely enlarged. In the centre of this diseased bone, its substance will be found softened with cysts interspersed, which contain a fœtid ichorous fluid; sometimes a gelatinous substance is found occupying this position.

Symptoms.—In all cases of this disease, there is deeply seated pain, which frequently continues for a long time before any swelling of the part becomes perceptible; as the disease advances, the pain increases and becomes of a lancinating kind, which very much impairs the general health; a tumour is then felt, which is hard and tuberculated to the touch, pressure does not lessen the size of the tumour, nor increase the pain. The soft parts next become inflamed and painful, after which the skin ulcerates; but if the disease be in the orbit, before this latter stage can

take place, vision is lost. The ulcer that forms, presents a cancerous appearance. If by this time, the disease has not caused death by destroying the bones of the skull and attacking the brain, hectic symptoms are induced, the strength gradually fails, and the patient, at length, after much suffering, falls a victim to the disease.

Treatment.—No treatment is of any use except to alleviate the patient's sufferings by palliatives, and make his passage from this life as easy as possible. This is best accomplished by giving anodynes internally, and applying soothing applications to the part affected. The employment of escharotics, or any attempt at an operation, only causes matters to become worse.

CHAPTER IX.

DEFORMITY OF THE ORBIT FROM EXTERNAL PRESSURE.

Under this head I propose to treat of pressure on the bones of the orbit, from disease of its surrounding cavities.

It is a physiological fact that all abscesses or tumours situated in any part of the body, as a general rule, proceed towards the surface, and in their progress destroy both soft and hard parts, causing them to be absorbed by the pressure which they produce. Tumours forming in bony cavities, as they increase in size, must produce one of two effects,—either they may tear the bones asunder, or they will cause them to be absorbed. If tumours of a malignant nature form in any of the sinuses connected with or adjacent to the orbit, such cases must terminate fatally unless the whole of the surrounding parts are removed by an operation when the disease is in the early stage. I shall therefore make no remarks on them, more particularly as those which I have made in the preceding chapter on osteo-sarcoma will apply to them.

Absorption and deformity of the bones of the orbit may be caused by pressure on them, from the nose, the frontal sinus, the maxillary sinus, or the cavity of the cranium.

Tumours of the Nose.—The tumour which forms in the nose, and which is likely to affect the orbit, is nasal polypus. After a polypus has filled the nares, it presses upon the nasal duct, and thus obstructs the flow of tears; it may then displace the os unguis, and form a tumour in the situation of the lachrymal sac. At this stage there is painful pressure experienced in the orbit, and often through the

head. If the tumour be allowed to grow, the nasal bones will be separated from the maxillary, the orbit will be pressed upon, the eye-ball displaced, and vision destroyed; finally the cavity of the brain may be intruded upon, and death the result. During the progress of the disease, epistaxis will often take place; but generally speaking, the bleeding is a sign of the tumour being more or less malignant in its nature.

Prognosis.—If the case be seen in its early stage, the removal of the tumour will produce a cure, even though the bones should be a little displaced; but should any of the bones have been absorbed, deformity will be the result.

Treatment.—When a polypus is discovered in the nose, it should be immediately extirpated, if allowed to become large, and displace the bones, this is not so easily effected. There are many who would not submit to its being extirpated. In such cases, I have succeeded in removing it by applying to its surface the acetabulum every morning, and plugging the nose with a piece of sponge, so as to make direct pressure on the tumour. By this means I have removed such tumours as completely as if they had been extirpated. However I would not pursue such a treatment from choice, except when the base of the tumour had a great attachment. If it were a pendulous polypus with a small root, the proper treatment would be to twist it out. It is astonishing how readily after the removal of such tumours, the displaced bones will return to their natural position.

Maxillary Sinus.—This cavity is often the seat of all sorts of tumours, and of abscesses. When a polypus grows in this cavity, its root is generally from the roof of the cavity, which is the inferior surface of the floor of the orbit, as this tumour increases in size, the part which first gives way is its internal boundary, and the polypus passes into the nares, when it is often mistaken for a nasal polypus. The body of the tumour having thus escaped from the

antrum, may save the orbit, but should it remain in the cavity, it will produce similar, if not worse results than nasal polypus, for its first effect may be to push up the floor of the orbit, and press at once upon the the globe of the eye. Tumours of a different nature, particularly malignant, generally speaking destroy the anterior wall of this sinus, and then make their appearance under the eye, upon the cheek.

The existence of any tumour in this cavity is very obscure while in the incipient stage ; still it may be discovered before it produces any serious deformity.

“This information,” says Mr. S. Cooper, “may be acquired by examining whether any of the teeth have become loose, or have spontaneously fallen out ; whether the alveolar processes are sound, and whether there are any fungous excrescences making their appearance at the sockets ; whether there is any habitual bleeding from one side of the nose ; any sarcomatous tumour at the side of the nostril or towards the great angle of the eye. When the swelling however has attained a certain size, the bony parieties of the antrum always protrude, unless the body of the tumour be situated in the nostril and only its root in the antrum. This case however is very uncommon.”

Collections of pus or mucus in the antrum are generally the result of blows, or cold, producing inflammation of the mucous membrane. Carious teeth often act as a cause,—the effects will be similar to those produced by tumours.

Symptoms.—The pain is like that of tooth-ache ; but the pain extends more into the nose than it usually does from a bad tooth, and it often extends into the frontal sinus, orbit and eye ; as the disease advances, a hard tumour is perceptible on the cheek bone, sometimes circumscribed and elevated ; finally the swelling extends over the whole cheek.

If the matter is not evacuated, it may make its exit into the nostril, or between the fangs and socket of the teeth into

the mouth ; or it may render its floor carious, and may burst into the mouth ; however, before it escapes, it generally pushes up and destroys the floor of the orbit.

Diagnosis.—The best way to diagnose whether a tumour or fluid is in the antrum, is to extract the last molar tooth but one from the upper jaw of the affected side ; then by pushing a probe through the aperture, left by the removal of the fangs of the teeth, up into the cavity, if it is matter that is collected, it will be thus discharged,—if it is a tumour, the touch with the probe will shew whether it is hard or soft.

Prognosis.—If nothing but mucus or pus is in this cavity, the prognosis may be favourable ; if a polypus, less favourable, from the difficulty there is of getting at it ; and if it is any other sort of a tumour, of course it will be still more unfavourable. If the tumour be malignant, nothing but the removal of the superior maxillary bone will save the patient's life.*

Treatment.—If the disease is discovered to be pus or mucus collected in the antrum, it should be at once evacuated, and that in the manner recommended to discover the disease, viz :—by extracting one or two of the molar teeth, and if this should not evacuate the matter, a probe or awl should be pushed up into the cavity through the opening left by the fangs of the teeth, which aperture can be kept open by a tent of lint, a wooden peg or a small piece of gum elastic catheter; after the matter shall have been all discharged, the cavity should be made to heal by throwing into it with a syringe stimulating injections two or three times a day. The best lotion is two or three grains of nitrate of silver to the ounce of water.

*This operation I have seen successfully performed, in the presence of Drs. Campbell and Crawford, and some medical students, by Dr. R. L. Macdonell of this city, and I believe I am correct when I say it was the first time the operation was performed in Canada.

If the disease be polypus or any other tumour, it must be extirpated from the cavity. To accomplish this, an opening must be made into the cavity, which, at all times, is a nice and delicate proceeding. The mode of performing the operation is as follows;—the patient being seated, the surgeon is to form a triangular flap, with its base upwards, external and inferior to the infra-orbital foramen; two oblique incisions should be made, one outwards and downwards, the other, downwards and inwards,—both incisions meeting at their inferior extremity, and thereby forming a V; the flap should then be dissected up from its apex to its base; in making the incisions, the knife should reach at once to the bone. The bone should be perfectly cleaned; then the surgeon may with a trephine or other appropriate cutting instrument, remove the bone from the front of the cavity, and thus expose its contents to view. When the operation has proceeded so far, no matter what the contents of the cavity may be, they should be removed as quickly as possible, the operator taking care that he removes every particle of the diseased mass: during which, and after, there may be such hemorrhage as will be found very difficult to stop,—indeed, sometimes it requires the actual cautery. However, generally speaking a dossil of lint previously dipped in the liquor plumbi diacetatis and applied to the part, will be found to succeed in stopping the hemorrhage; which dossil should be removed after two days, when the cavity will be found secreting a white foetid discharge.

The after treatment will consist in healing up the cavity, which will not be found very difficult, if the tumour has not been malignant; the aperture should be kept open by the most convenient means, so as to allow the free escape of the matter; and to accomplish this, one side of the flap and its apex may be united by the first intention, the other side kept from uniting by a small plug of lint placed between the edges of the wound. There should be free injections of a

weak solution of the nitrate of silver into the cavity; or if the discharge is very foetid, a solution of chloride of lime will be found the best means to correct it; (strength one scruple to two pints of water.) These means, and improving the general health, by tonics, change of air, &c., constitute the after treatment, and if all should go on well, the bones will gradually return to their natural position, and all deformity disappear; but such a termination is not to be expected for a long time. When the tumour is found to be malignant, the bony cavity should be well scraped after its removal, or what perhaps would be better, the cavity might be seared with the actual cautery, and, if the bones be found diseased, the superior maxillary should be removed.

In such cases Desault recommended the removal of a considerable portion of the alveolar process with a gouge and mallet, and Mr. Liston recommended the removal of all the bone and tissue found implicated in the disease. I do not see the propriety of Desault's treatment, unless the part to be removed is affected or tainted with the disease. Mr. Liston's advice no doubt is good, but cases may occur when to follow it, it would be necessary to remove the half of the face. Mr. MacKenzie, in his treatise on disease of the Eye, mentions two cases given by Mr. Pattison, of aneurism by anastomosis in the maxillary sinus, where a cure was performed by tying the common carotid.

Frontal Sinus.—The frontal sinus is liable to similar diseases as those found in the maxillary; and when we remember its close approximation to the orbit, we will not wonder that disease of it should affect this latter cavity. When inflammation of the lining membrane of this cavity is produced by cold or any other cause, it generally ends in suppuration: this matter may discharge itself into the nose, and thus produce a happy termination; but if it should not be so discharged, it will separate the two tables of the frontal bone, then depress the roof of the orbit, which will of

course press upon the eye ; the bone will then become perforated by caries or absorption, the matter will run down at the internal canthus of the eye into the cellular tissue, and so near the lachrymal sac, as to resemble in appearance disease of that sac.

Diagnosis.—The diagnosis in such a case is very difficult. Inflammation of the lining membrane of this cavity is generally accompanied with inflammation of the Schneiderian membrane. The patient complains of having a cold in his head, a heaviness in the eyes, &c.; as the disease advances, these symptoms increase, sometimes to such a degree as to cause much fever. When matter is fully formed, great tenderness of the part is complained of on pressure.

Prognosis.—If the disease is discovered in its first stage, the prognosis may be favourable, and not even very unfavourable if caries has taken place ; but if amaurosis has been produced by the pressure of the bones on the eye-ball, there is much doubt whether vision will ever be restored, even though the pressure should be removed.

Treatment.—Antiphlogistic means should be adopted in the first stage of the disease. Leeches over the frontal sinus, or to the inside of the nostril, will be found of great benefit ; warm vapours drawn up into the nostril will also be useful, and suppuration may be prevented by counter-irritation to the external parts covering the cavity. When suppuration and distortion has taken place, the sooner the matter is evacuated the better, either by a trephine or strong knife ; after which the unhealthy state of the lining membrane must be improved by injections of the nitrate of silver solution ; then the parts must be allowed to granulate and heal.

Should this cavity be the seat of any tumour, the same remarks that have been made respecting the antrum will equally apply to it ; but the surgeon, when operating, must remember its close proximity to the brain, and be guided in his treatment accordingly.

Sphenoidal Sinuses.—The sphenoidal sinuses are situated at the anterior and inferior parts of the sella turcica, and bound the inferior and internal side of the foramen opticum.

The two sinuses are separated from one another by a bony partition, and each of them opens into the upper meatus of the nostril on its own side; their lining membrane is a continuation of the Schneiderian membrane.

If matter were collected or tumours formed in one of those sinuses which would dilate the cavity, it must very likely deform the apex of the orbit, and thus cause pressure upon the optic nerve, and all parts passing through the optic foramen, which would produce amaurosis.

The tumour may more likely find its way into the nostril, which would be better, or it may press upwards upon the base of the brain, and, after causing many bad and severe symptoms, terminate in death.

Diagnosis.—Until the contents of these cavities, be disclosed by bursting into the nares or orbit, I think it impossible to tell the disease; and even in the latter case the diagnosis would be very difficult.

Treatment.—If the disease be diagnosed some good effects may occasionally be produced by the exhibition of mercury, iodine, or other alterative treatment.

Cavity of the Cranium.—The roof of the orbit may be pushed down on the eye-ball, or become absorbed or necrosed, from tumours, &c., in the cavity of the cranium. Of course, in such cases, the eye is only a secondary consideration, for the disorder disorganising the brain, the case must end in death. As to treatment, all that can be done is to allay the patient's sufferings.

CHAPTER X.

DISEASE IN THE ORBIT—CONTINUED.

Tumours in the Orbit.—The cavity of the orbit, like all other bony cavities, is liable to the growth of tumours, and no matter what description of tumour it may be, whether malignant or otherwise, the natural consequence must be pressure on the eye-ball, its nerves and vessels, with more or less displacement of all. Such a state must produce amaurosis, accompanied with pain in the head ; and finally inflammation and destruction of the eye-ball, and even death may be produced, from the bones of the orbit pressing upon the brain.

Tumours of the orbit may grow from any part of it, but their most frequent situation is from the inferior and posterior parts of it, and less commonly, the nasal or temporal sides. Their attachments to the orbit differ very much, being sometimes loose and easily detached, at other times firmly adherent, and interwoven with all the soft parts of the orbit.

The tendency of all tumours in the orbit is to protrude out of that cavity.

Diagnosis.—The difficulty of diagnosing the sort of tumour that is growing in the orbit is sometimes very great, and more particularly as the eye-lids often become so œdematous and swollen as to conceal not only the tumour but the eye-ball itself.

The tumour may be either sarcomatous, encysted, fungous, melanotic, osseous or aneurismal. The encysted may be various in its contents,—if limpid, like the white of an egg, it is called *hygroma*,—if thick like suet, *steatoma*,—if

like pap, *atheroma*,—and if like honey, *meliceris*. If the tumour is encysted, its growth is rapid, and feels like the fluctuation of pus,—if sarcomatous, its growth is slow, seldom reaching to a great size, and its consistence firm and hard.

Causes.—The causes of tumours in the orbit are, like tumours in other parts, very obscure; some attribute their growth to blows, cold, &c.; however they as often appear without any known cause.

Prognosis.—The prognosis will depend upon the sort of tumour that is present, how far advanced, and what destruction may have been caused.

Treatment.—Generally speaking the only cure for a tumour is extirpation. However, if the case be not very pressing, and the constitution is affected with either syphilis or scrofula, mercury or iodine may be given with a view of causing the tumour to be absorbed, and, in either case, leeches should be applied to it, and counter-irritation should not be neglected. When the tumour is encysted, some have recommended a palliative treatment, by puncturing and evacuating the contents of the sac, but it is not a treatment I would recommend, knowing that the severe inflammation which often follows such treatment is likely to produce much more harm than would ensue by its complete removal. I would therefore recommend that, if possible, the whole tumour should be extirpated; and if this cannot be done without injuring very important parts, as much of the tumour should be removed as is practicable, and we must trust to suppuration and the application of caustic to remove the remainder of the sac, when the wound will be constantly found to heal without much difficulty, and with but little deformity.

Previous to commencing the operation, the surgeon should always determine on total extirpation, as until after he shall have commenced the operation, he never can tell what ob-

stacles he may meet with, which may induce him to extirpate it only partially. The chief difficulties to be met with are the great depth of the tumour, the cyst being ruptured, and hemorrhage ensuing. There is a treatment, however, not a palliative, that I have much confidence in, if there is much difficulty found in extirpating the tumour, or that important parts must be cut through for its removal, that is, to make a free opening into the tumour, squeeze out all its contents, and then destroy the cyst by the application of the nitrate of silver.

Mode of Operating when the Tumour is to be extirpated.—The patient being seated, and his head supported either by an assistant or by an operating chair, the surgeon should make a transverse incision through the skin of the eye-lid, from which he intends to remove the tumour, parallel to the fibres of the orbicularis palpebrarum muscle. As the cyst is often near the surface, great caution is required lest the sac should be opened. The cellular substance under the muscle should be next divided, and its connection with the cyst separated with the handle of the scalpel: the tumour should then be taken hold of with a pair of blunt forceps, and dragged forward, when its posterior connection may be divided with a knife or pair of scissors. The surgeon should next examine the cavity and satisfy himself that he has left in it no diseased part. The next step is to restore the eye-ball to its natural position, if previous to, or during the operation, it had been displaced. The parts must be allowed to heal by granulation. The after treatment will depend upon the symptoms that present themselves: perhaps the best local application is water dressing: as a general rule in all such cases, the patient will require to be kept perfectly quiet. The consequences which may follow this operation, are: *First*, Such inflammation and suppuration as will produce destruction of all the parts in the cavity, even spreading to the brain and producing death. *Secondly*, The

external wound healing up and suppuration going on internally, though this can be prevented by keeping the wound open. *Thirdly*, Erysipelatous inflammation may set in and spread over the head. *Fourthly*, There may be deformity of the lid by its becoming everted, and it is to avoid this that the incision should be made as far as possible from its edge and parallel with the fibres of the orbicularis muscle; *Fifth*, Ptosis may be produced by cutting the fibres of the levator palpebræ muscle; therefore, if possible, this should be avoided. *Sixthly*, There is danger of wounding some part of the lachrymal apparatus. And, *Seventhly*, Amaurosis may be produced by wounding the ophthalmic branch of the fifth nerve, so it is quite evident the operator should not be too sanguine when about to remove any tumour from the orbit.

If the surgeon find that he can evert the lid and extirpate the tumour through the conjunctiva, such a mode is far preferable to making an incision through the lid.

These remarks on the removal of encysted tumours are equally applicable to the removal of all other tumours, with the exception of those of a malignant nature, when, under no pretence whatever, (even to the removal of all the parts in the orbit,) must the surgeon leave any portion of the diseased mass behind him. If the tumour be bony, it must of course be cut away. (See Exostosis, page 95.)

If the orbit be the seat of aneurism by anastomosis or nævus maternus, like this malformation in other parts, except with regard to its appearance, it may be but of little consequence, but if it swells and increases in size, it may produce the same effects as any other tumour. The aneurism may be either passive or venous, active or arterial. Mr. John Bell described such a disease, or at least something similar, not an original malformation, but sometimes appearing in healthy adults without any apparent cause. He gave to it the name of aneurism from anastomosis.

If the surgeon be called upon to treat such a case, in consequence of the aneurism forming a tumour, and producing pressure on the eye-ball, there are only two modes of treatment from which any benefit can be expected. One is tying the common carotid artery. For a proof of the benefit arising from this treatment we are indebted to Mr. Travers, who first essayed this practice, and was followed by Mr. Dalrymple. The second mode of treatment is extirpation which is certainly not so good as the first; indeed it is a most serious operation, as arresting the hemorrhage is found to be most difficult. If the tumour were deeply situated, and I were to attempt its removal, I think I should remove every part within the orbit, particularly if the sight should have been already destroyed. Some authors have recommended a palliative treatment, by puncturing the aneurism, in the hopes that it would be obliterated by the pressure of the extravasated blood: If the aneurism were superficial, this might be successful, but if the tumour were deeply seated in the orbit, I doubt very much the success of such a practice, and it is possible that the extravasated blood might do more harm than the disease. True aneurism of the ophthalmic artery has been found to exist; however, such cases are rare. Mr. Guthrie saw a case of aneurism of both ophthalmic arteries in one person, each of them about the size of a large nut; protrusion of the eye-balls was produced by these tumours. While the patient was in life, he recognized the fact of aneurism of some of the arteries of the head, but did not know their situation till he discovered them after death. If such a case is discovered during life the only treatment from which any benefit could be expected would be tying either the common or internal carotid and even from this, much must not be expected.

CHAPTER XI.

DISEASES OF THE ORBITAL CELLULAR MEMBRANE AND TUNICA VAGINALIS OCULI.

The cellular membrane of the orbit may be attacked with inflammation or with malignant disease. Inflammation of it may be caused by wounds, blows, cold, &c. It may be either acute or chronic, and may either originate in the cellular membrane or spread into it from the surrounding parts.

Symptoms.—Inflammation of the orbital cellular membrane is always of a phlegmonous character, and has two distinct stages, viz :—the first or inflammatory, the second or suppurative. In the first stage there is acute pain, deep in the orbit, which extends to the forehead and temple ; there is a feeling as if the eye were pressed upon, and any attempt to move or touch it increases the pain ; as the parts continue to swell and push the eye-ball forward the patient complains of flashes of fire in the eye, the pain still increases as the nerves are put on the stretch, the pupil becomes contracted, and vision is lost, or nearly so ; all this time there is great epiphora. The conjunctiva next becomes red and chemosed, and sometimes the whole eye will partake of the inflammation, and when this takes place the iris will be motionless ; as the eye protrudes the epiphora ceases, the lids become painful, swollen, and red, and move with great difficulty.

The constitutional symptoms are,—pulse hard and frequent, face flushed, skin hot, thirst great, restlessness, and sometimes delirium. If the inflammation extend to the

membranes of the brain, there will be the symptoms of phrenitis.

Rigors generally precede or usher in the second stage ; the pain becomes more severe and pulsative, and the delirium increases ; the matter pressing upon the back of the eye-ball causes it to protrude, and is found to fluctuate either behind the conjunctiva or between the eye-lid and the edge of the orbit, or in both places ; vision at this stage is generally totally destroyed, from the stretching which the optic and fifth nerves receive, even should the eye itself not have been involved in the inflammation. This collection of matter being evacuated spontaneously, is likely to leave various openings, sometimes leading into the surrounding cavities, (for the bones of the orbit may give way,) and should the matter find its way into the cranium it would of course cause death.

When the eye-ball is affected, and the second stage sets in, all the symptoms will be found increased ; matter will be seen either behind or in the substance of the cornea, which soon bursts and causes all the humours to evacuate.

Diagnosis.—In the first stage of this disease, the symptoms are greatly concealed, but the rigors which usher in the second stage, with the severity of the local symptoms, generally show when it has commenced.

Prognosis.—This will depend upon the stage of the disease, and the patient's general constitution. If vision is lost in the first stage it may be restored by subduing the inflammation, and even in the second stage, although vision cannot be restored after pus is formed behind or in the layers of the cornea, still the shape of the eye may in some degree be preserved after the purulent matter has been discharged. Head symptoms in the first stage may be controlled, but if they appear in the second stage there is just reason to fear that the matter has found its way to the brain, and consequently that death will ensue.

Treatment.—In the first stage in this disease the general and local treatment must be bold and decided, for if dallied with, it is sure to run rapidly into the second stage. There should be, first, general bleeding, so as to produce syncope; this should be followed by a smart purge and nauseating doses of tartarised antimony, which would also act diaphoretically. Five or six grains of blue pill with the same quantity of the extract of hyosciamus may be given at bed time. It may sometimes, but not frequently, be necessary to give more mercury. To keep up the action of the skin, kidneys and bowels, I generally give the following mixture, with the best effect: Sulph. magn. ℥i, Antim. Tart. gr. i, Liquor amon. acet. f. ℥iv, aquæ font. f. ℥iii, M fiat mistura. sumat coch, mag. tertia quaquâ hora.

The local treatment consists in applying leeches to the orbit; evaporating lotions of the liquor plumbi acetatis to the same part, cold to the head; and a large blister to the nape of the neck. Rest and abstinence should be particularly attended to.

The treatment in the second stage is to evacuate the matter as soon as it is discovered, even before the abscess points. If there is a choice of parts to evacuate the matter through, the conjunctiva should be preferred to cutting through the eye-lid; as to the mode in which the opening should be made, the operator must be guided by circumstances, but more particularly by his anatomical knowledge; at all events the pus must have free vent. After the matter has been evacuated, a dossil of lint should be put into the wound to keep it from healing, and a warm poultice applied three or four times a day, the patient lying in such a position as to favour the discharge of the matter. On no account should the external opening be allowed to heal till the cavity granulates from the bottom, to favour which (after some time) it may be found necessary occasionally to inject the cavity with stimulating lotions. If during the first or second stage of

the inflammation the chambers of the eye become distended with pus, so as to endanger the bursting of the eye-ball, I would recommend an opening to be made in the cornea and the pus evacuated: but if the quantity of matter in the chambers be small and not presenting all the characters of pus, it may be left to the absorbents to remove.

Four or five days after the matter has been evacuated, the dangerous symptoms generally disappear, when the strict antiphlogistic regimen may cease; and if the patient is very weak such tonic treatment may be required as will not excite the vascular system; a light nutritious diet should also be ordered.

A person of scrofulous or syphilitic constitution is the most likely to suffer from chronic inflammation of the orbital cellular membrane; when this does occur, it is slow in its progress, and matter is formed without any pain. As the matter accumulates, the lids become swollen, red, and everted, and the eye-ball protrudes more or less. The abscess finally bursts, and for a length of time there remains an ichorous discharge. The following is a remark made by Mr. Mackenzie, (page 296 of his work): "It sometimes happens from the indurated and adherent state of the cellular membrane, consequent to orbital abscess, that the eye-ball remains permanently protruded and motionless. In this case the tears run over the cheek, the eye-lids cannot close, the surface of the eye becomes inflamed and tender, and the patient continues subject to head-ache, watchfulness, and great anxiety." Mr. Mackenzie mentions no treatment for such a case. I have never seen a similar one, but if I should happen to meet with it I would not hesitate to evacuate the humours of the eye, and let it collapse, for I see no reason why the patient should be left to suffer such torture when all chance of cure is past.

Infiltration of the Orbital Cellular Membrane.—Exophthalmos is sometimes produced by the infiltration of serum into

the cellular membrane of the orbit. Here the eye-lids are generally found swollen, and all the severe symptoms of abscess of the orbit present themselves. The surgeon indeed generally supposes that he has to do with an abscess, and only discovers the true nature of the infiltration after he has made a puncture. Such cases are generally found in persons of a scrofulous constitution.

Treatment.—If there are severe head symptoms the general antiphlogistic treatment must be resorted to, avoiding blood-letting, however, if possible; but generally speaking it will be sufficient to give an occasional purge of rhubarb and calomel, apply leeches to the orbit and behind the ear, and produce counter-irritation on the nape of the neck, by means of a seton or otherwise. If the subject of the disease is young, and the case chronic, the chylopoietic viscera will be found deranged, requiring particular attention. Iodine will be found useful in this disease.

Scirrhus of the Orbital Cellular Membrane.—This diseased state of the orbital cellular membrane is found in persons predisposed to scirrhus. The exciting cause is usually a blow or other injury. A hard tumour forms in the orbit; and it is with much difficulty that its nature can be diagnosed till its white striated structure is exposed at the period when an attempt is made towards its removal.

Treatment.—To extirpate every portion of the diseased mass with the knife; and the sooner this is done the better; for there will be the less to remove, and a greater chance of a successful termination.

Inflammation of the Tunica Vaginalis Oculi.—I. M. Ferrall, Esq., M. R. I. A., Adviser in Ordinary to St. Vincent's Hospital, states that this membrane is sometimes the seat of rheumatic inflammation, and in support of his opinion quotes three cases that came under his observation. In the first case relief was obtained in some degree by bleeding and general antiphlogistic treatment, but there was no perma-

ment relief until the system was affected with calomel. The symptoms in that case were want of sleep, intense pain in the eye-ball, forehead and temple; the eye projected three quarters of an inch, the lids were swollen, œdematous, and of a dusky red color; the conjunctiva protruded over the cornea, in the manner of a chemosis, its color pale amber, and evidently distended with serum; the cornea and iris were perfectly healthy; pain was increased by pressing the eye-ball directly backwards, but was not augmented upon pressure of the eye-ball upwards, and towards the periostial covering of the roof of the orbit.

His second case was a man aged 32 years. The following are the symptoms he gives of it :—"Violent inflammation and protrusion of the right eye; the cornea and iris healthy, vision confused, conjunctiva projecting around the cornea and of an amber color, the eye-lids swollen and of a dusky red hue, surface marked by a number of distended veins. The patient complained of agonising pain in the globe of the eye, and a sensation as if it were being dragged out of the orbit; this sensation always continued, but the pain was liable to severe exacerbations; moderate pressure on the eye-ball, with the palm of the patient's own hand, seemed to relieve him, although he could not bear any one else to touch it. Pressing the superior palpebræ towards the roof of the orbit gave no pain; at the beginning of the attack there were occasional flashes of light before the eye."

The patient had been suffering from rheumatism in his knees and legs, six weeks previous to the attack in his eye, and at the time Mr. Ferrall saw him there was slight fulness from effusion in the capsule of the left knee joint, and tenderness with tumefaction about the middle of the right tibia. The man was of intemperate habits, and six years previously had suffered from syphilis, for which he had taken mercury largely.

The treatment in this case was the same as in the preceding, and with the same result; the only difference was bleeding from the temporal artery instead of the arm.

His third case was a woman of 48 years old, who previous to the attack of the eye, had been for a week in hospital for rheumatism with swelling of the knee joints from effusion into their capsules. The swelling of the knees had nearly disappeared, when she was seized with acute pain in the right eye; there was no appearance of inflammation for twenty-four hours after; on the second day the pain increased, with occasional flashes of light; the eye-lids were inflamed and swollen, and the eye projected. The cornea and iris were healthy, and looked clear in the midst of a prominent chemosis, which was of a yellow amber color. The lids were swollen, and did not cover the eye; the upper lid presented the dusky red colour, and tumid appearance described in the second case. The superior portion of its surface did not, however, participate in this change, two parts being separated by a very distinct line of demarcation. Pressure directed towards the roof of the orbit produced no pain, and the sight was not impaired; there was swelling and great tenderness over the left tibia.

The treatment that he adopted in this case, was to give ten grains of the hydriodate of potass every three hours; after the woman had taken seventy grains she declared herself better, although no difference could be perceived in the state of the eye. The fifth day the medicine was stopped, as all traces of the disease had disappeared; even the tibia had recovered its healthy state. In 36 hours following, the left eye became attacked with the same disease, which, after ten days, yielded to the same treatment; the dose of the medicine was increased to 15 grains every three hours, and gradually reduced again as the eye improved.

The following are the conclusions drawn by Mr. Ferrall:
“ That protrusion of the eye-ball which when attempted to

be explained by uncomplicated periostitis, requires some stretch of imagination, appears a very simple and inevitable result of inflammation of the tunica vaginalis oculi. There are here no soft parts to receive and divide the pressure, or protect the globe. The tunic is supported by other fibrous layers on its outside, as well as by the muscles which constitute the sheaths. Inflammation of this capsule must then be immediately followed by pressure; and when we recollect its conical form, and that, as happens in the cases of inflammation of other fibrous tissues, effusion at once takes place in the cellular membrane connecting it to the ball of the eye, we perceive there is nothing to prevent the dislocation of the latter.

“ This effusion into the cellular tissue will make itself evident in another way; the conjunctiva, at the place where it forms the fold, in being reflected from the eye-lid to the eye, closes up the tunica vaginalis in front. At this point it will not only receive the pressure of the effused serum, but will become separated from its connection with the sclerotic coat, by the extension of the infiltration; hence the amber coloured chemosis of the conjunctiva without vascularity. Chemosis, originating in conjunctivitis, always presents in addition to serous infiltration beneath, one or other of the forms of hyperæmia. The chemosis of which we treat is in uncomplicated cases the consequence of effusion from a deeper source. I can easily imagine the extension of inflammation from the fibrous structure of the lid, to its conjunctival surface, and thence to the sclerotic conjunctiva; but this complication did not occur in the cases which I have related. In distinguishing these cases I would not be supposed to mean, that inflammation of this tunic is a disease apart, and never combined with a similar condition of the periosteum or cellular tissue, on the one hand, or inflammation of the eye-ball itself on the other. I am aware they may exist together, for I have seen such cases.

All I mean to assert is, that inflammation of the tunic described, may be the primary affection, and the point of departure from which the diseased action may spread to the other fibrous layers in the orbit, and finally reach the periosteum ; and that the attack may even be limited to the tunica vaginalis oculi, that it may here produce a train of symptoms of the most dangerous kind, and which have been hitherto supposed to reside in the periosteum, because the existence of other fibrous membranes in the cavity was not suspected."

In the first part of this work, page 4, the anatomy and physiology of this tunic is given as described by Mr. Bonnet.

I have never seen the disease so well defined as described by Mr. Ferrall, but previous to reading his remarks, I had seen two cases in which all the symptoms described by him were present, in the early stage of the disease, but the whole of the parts in the orbit soon partook of the general inflammation ; one case was that of a strong young man ; the case yielded to mercury ; the other case was an old man ; I trusted to antiphlogistic treatment in his case, and he lost his eye. The diagnosis in such a case must always be very obscure ; I must confess that I do not see the difference between it and sclerottitis ; certainly it is very difficult to draw the line of demarcation between the two diseases.

CHAPTER XII.

DISEASES OF THE SECRETING LACHRYMAL ORGANS.

Before discussing the diseases of these organs it may be as well to mention that they may be wounded, although from their situation they are not very liable to be so, indeed, unless a penetrating wound is given upwards and outwards the gland is sure to escape; or unless the wound penetrates the orbit from the outside at the superior and external angle. There are two sources of danger to be apprehended from wounds of the lachrymal gland and ducts; one is the distilling of the tears through the external wound, which would prevent it from healing, and thus form a true fistula lachrymalis; to prevent this accident the edges of the wound should be brought as close as possible together with adhesive plaster, and if necessary a couple of stitches; then the whole should be covered with a compress and bandage, and every effort made to cause union by the first intention. Should the surgeon fail in his efforts, and a true fistulous opening be formed, I would recommend a fistulous opening being effected by seton, or otherwise, through the fold of the reflected conjunctiva, which will conduct the tears over the eye and then the external opening will heal.

The second danger from such an injury would be inflammation, terminating in suppuration of the gland, and obliteration of the lachrymal ducts, giving rise to an incurable xerophthalmia or dryness of the eye. The treatment of inflammation of the gland will be spoken of under its proper heading.

Xerophthalmia.—By this term is meant dryness of the eye, which may be owing to different causes. There are two descriptions of the disease; the one is to be referred to a want of tears, the other a want of mucus. The first description may be caused by inflammation of the lachrymal gland, causing its secretion to be suppressed; *secondly*, the secretion may be suppressed from a want of nervous energy in the gland; *thirdly*, if the gland becomes indurated, it will cease to secrete; as people grow old, all their secreting glands become shrunken, and cease to secrete in a more or less degree; therefore this disease is occasionally met with in the aged. Obliteration of the lachrymal ducts is another cause of the first species of xeroma. The second species, want of mucus secretion, is caused by some derangement of the ophthalmic branch of the fifth pair of nerves, and is generally accompanied by amaurosis in a greater or less degree. From the conjunctiva not secreting, although the tears pass plentifully over the eyes, the patient always complains of their feeling stiff and dry. Mr. Mackenzie says that in such a case, the conjunctiva continues to secrete mucus, but my experience leads me to a different conclusion. This description of xeroma may be produced temporarily by deep grief, which is nothing more than a sympathetic nervous affection.

Treatment.—The treatment of this disease will depend upon the cause. If it be inflammation of the gland, as soon as the inflammation is removed the disease will disappear; if it is owing to obstruction of the ducts, some good effects may be induced by causing a fistulous opening in the reflected portion of the conjunctiva; if it be from induration of the gland, or from old age, the disease is incurable, and in these two varieties the best substitute for tears is occasionally dropping on the eye-ball a weak solution of the nitrate of silver, which will also prevent ulceration of the cornea. If the secretion of mucus cannot be restored, the same treat-

ment must be adopted. If there be suppression of either mucus or tears, from want of nervous energy, every effort must be made to restore the nervous vigour; for this purpose I have found electricity of the greatest service. This should be used every morning, by drawing sparks from the affected eye and orbit, or by the use of the electro-magnetic instrument; a strong solution of nitrate of silver, eight or ten grains to the ounce should be also dropped on the conjunctiva once or twice a day; blisters should be applied before and behind the ears; the eye-lid and all round the orbit should be brushed every day with a ten grain solution of veratria prepared as below.* Sternutatories should not be neglected; indeed it is from the great benefit that has accrued from the action of this class of remedies that so many patent snuffs have been puffed up by quacks as cures for all diseases of the eye, including even blindness, no matter from what cause it may arise.

The constitutional treatment in such cases, is tonic, keeping the bowels and all the secretions regular; and if possible the patient should have change of air. The same treatment is necessary if the cause be grief, but antispasmodics should also be given. However, time, change of air and scene, constitute the best form of cure, since, as it has already been shewn, the disease in such cases is only temporary.

From what has been said on the subject of xeroma, the reader will perceive that in reality it is not a disease, but the symptom or effect of a disease. The disease to be next considered may be regarded in the same light.

Epiphora.—This disease is in its characteristics the exact opposite of the preceding. It consists in too great a flow of tears, arising from increased action of the lachrymal gland; but *this* must not be confounded with stillicidium

*℞ Veratiae gr. x ætheris sulph. ℥ii Spt. vini rect ℥i.
Solve veratrium in æthere deinde adde spiritum vini Rectificatum.

lachrymarium, which is caused by a disordered state of the excreting lachrymal organs.

Causes.—The causes of epiphora, or an over-flow of tears, are innumerable: any thing which excites or stimulates the ophthalmic branch of the fifth pair of nerves, may produce it, let the cause be, chemical, mechanical, sympathetic, or otherwise. For example, any foreign body touching the conjunctiva, will produce it. Strong sudden light on the eye will also cause a flow of tears. Irritating the nose, and thus exciting the nasal nerve, will also act as a cause, as every one knows. Sympathy with the sorrows of others will produce epiphora, also grief, joy, teething, disordered digestion, worms in the intestines, pain, &c.

Hence it is evident that of all the nerves of the body, none sympathise more with the rest of the nervous system than the fifth pair; and when their intimate connection with the eye is considered, the numerous remote causes which produce disease of that organ will no longer cause surprise.

It is not unusual to find epiphora accompanied with partial amaurosis.

The most frequent cause of persistent epiphora is strumous ophthalmia.

Treatment.—To first discover, and then remove the cause, is the cure for this complaint.

If a foreign body be under the eye-lids, it should be removed; if teething be the cause, the complaint will disappear when the teeth have cut through the gums. In a word the treatment will, in all cases, vary with the cause. If the eye be weakened after removing the cause, the four or six grain solution of the nitrate of silver, may be dropped on the conjunctiva once or twice, every day.

Inflammation of the Lachrymal Gland.—True idiopathic inflammation of the lachrymal gland is so rare, that Beer met with it but seldom in a practice of twenty-seven years standing. According to Mr. Travers, however, it often

occurs, particularly in children. As far as my own experience goes I must coincide with Beer's opinion, and consider it of very rare occurrence. Nevertheless it does sometimes take place.

Symptoms.—The secretion of the gland becomes lessened, and xeroma is produced. This is followed by acute throbbing pain in the seat of the gland, which shoots into the eye-ball and forehead; there is also a great feeling of fullness, at the superior and external angle of the orbit. The conjunctiva becomes inflamed, and the eye-lid tense and swollen, particularly at its external angle. Vision is next impaired, and the free motion of the eye outwards prevented by the pressure of the swollen gland upon the eye-ball; as it advances, the eye-ball is pushed downwards and inwards towards the nose; the pain is greatly increased, the pupil is contracted and immovable, and it is nearly impossible to raise the upper lid. This is the first stage, and if not arrested, it soon runs into the second or suppurative stage. All the symptoms already enumerated are increased, flashes of fire before the eye are complained of, (sometimes delirium sets in,) rigors follow, which shew that suppuration has commenced, but the other symptoms do not abate; at length the matter is found to fluctuate, it points and finally bursts, either through the upper eye-lid or through the reflected conjunctiva. After this it is more than probable that the periosteum and bones of the orbit will be found to have suffered.

Causes.—The general causes are injury by blows, wounds, or cold. Inflammation of the surrounding parts sometimes spreads to the gland.

Treatment.—In the acute stage, the antiphlogistic treatment must be adhered to; general bleeding, leeches applied to the orbit, an emetic, followed up by an active purgative, and nauseating doses of tartarized antimony, with quietude and rest; these, with cold lotions of the acetate of lead to

the part, constitute the treatment in the first or inflammatory stage. Blisters before and behind the ears may be found useful. If tears begin to gush from the eye, the surgeon may feel pretty sure that the inflammation will terminate in resolution.

When once the second or suppurative stage commences, the moment fluctuation is perceptible, the matter should be evacuated, if possible, through the reflected conjunctiva, but if this cannot be done, through an opening made in the upper lid. After which poultices may be applied; the discharge, after continuing for some time, gradually diminishes, and finally stops, and then the parts heal up. If the abscess is allowed to burst, and the matter to evacuate itself spontaneously, it is more than probable that the bone will have become diseased.

In children of a scrofulous habit this gland sometimes becomes enlarged, and runs into suppuration without any of the symptoms of inflammation, except a sense of fulness above the globe of the eye. The eye-lid becomes tumid and œdematous, and there is an inability to move the eye outwards. This state of the gland differs also from that already described, in its being generally accompanied by a copious flow of tears, and often with frequent attacks of pustular conjunctivitis.

The progress of the disease is sometimes very slow; the gland often takes months to suppurate. The matter will be found, on opening the abscess, to be of a cheesy flocculent consistence.

In the first stage of such a case, leeches should be applied to the part, an occasional dose of rhubarb, soda and the hydrargyrum *cum creta* should be given at night. Iodine, both internally and externally, should not be neglected, and perhaps there is nothing of greater importance than change of air, and partaking of light but nourishing diet. When the second stage sets in, and when the skin over the abscess

is thin, the matter should be evacuated, a poultice applied, and quinine given internally. If at any time the pressure of the enlarged gland threatens the destruction of the eye-ball, the gland should be extirpated.

Chronic Enlargement of the Gland.—No matter what may be the character of a chronic enlargement of the lachrymal gland, whether scirrhus or otherwise, the symptoms at the commencement will be always found the same; viz:—epiphora, burning and lancinating pain in the region of the gland, and a small hard lobulated tumour, to be felt in the external orbital angle. This tumour soon elevates the skin of the eye-lid; from which time its growth proceeds with great rapidity; as it increases, it pushes the eye-ball downwards and inwards, the sight first becomes dim, and is soon totally lost. At this stage of the disease, if something be not done, the eye-ball inflames, suppurates, and bursts. The tumour continues to increase till it fills up the whole orbit; the lids become everted and expanded. Finally, if the patient is not worn out by pain and fever, the tumour will press upon the brain, and in that way cause death.

Diagnosis.—The diagnosis in such a case will be always difficult, as all the above symptoms, or nearly all, may be found to take place with any form of orbital tumour. If in the first stage the lobulated form of the tumour can be distinguished, it is a certain sign that it is the gland that is affected; but when the eye-ball bursts the tumour may be mistaken for fungus hæmatodes. It is very hard to diagnose between scrofulous and cancerous enlargements of the gland; age in some degree will be a guide, cancer being only found in old people, and scrofula in the young. If it be scrofula the tonsils or glands of the neck will be found enlarged, in fact the whole lymphatic system is deranged; when the tumour presents a green color it is called chloroma or green tumour; which is just as malignant as cancer.

Treatment.—While the tumour is in the incipient stage, and not pressing upon the eye-ball, benefit may be derived from the use of leeches, iodine frictions, and iodine internally; but when once it presses upon the eye, the sooner it is extirpated the better. If the eye has been displaced, some time will elapse after the tumour is removed, before it regains its natural position. If during the operation, the eye-ball is found destroyed, it should be removed at the same time. We must expect that the removal of the lachrymal gland will produce incurable xeroma.

Encysted Tumours in the Lachrymal Gland.—This is so rare a disease, that Beer in his practice only met with three cases, and Schmidt with two.

So similar are the symptoms to those that are found, when the gland is the seat of other tumours, that I see no means of diagnosing between them. Nor do I consider it of much consequence, as the treatment must be the same, viz. :—extirpation. However, Mr. Mackenzie recommends a palliative treatment in the following words—page 100 of the third edition of his work: “A palliative treatment, it is probable, will generally be adopted; by employment of this remedy we may save both the life and the eye of patient. It may even happen that by the early employment of this palliative regimen, we may be fortunate enough to cure the disease completely. No hope of this however need be entertained, if the eye-ball should be already protruded from the orbit, the power of vision lost, the eye-ball beginning to appear dusky and lifeless, or if it be violently inflamed and in part disorganized.

“The palliative cure consists in puncturing the tumour and evacuating the accumulated fluid. This should be done, if practicable, from under the upper eye-lid with a lancet, or small concealed bistoury, directed towards the seat of the lachrymal gland. Should the tumour return after the healing of the wound, the operation must be

repeated. I should think any attempt to keep the wound open, and the tumour constantly empty by the introduction of a bougie or other foreign body would be out of the question if the incision, were made from under the upper eye-lid. But if the protrusion of the eye were such that the upper eye-lid becomes firmly stretched over the eye-ball and thus admitting of no instrument being passed between them, the tumour would require to be opened through the upper eye-lid, and the wound might be afterwards kept open by a bit of catgut, so as to give exit to any re-accumulated fluid, and perhaps produce a radical cure."

There is one great satisfaction in this palliative treatment of Mr. Mackenzie, which is, that if it does not succeed, it does not prevent the extirpation of the tumour; but for my part I would not trust long to it, if I found the eye in danger of being pressed upon. Another benefit, by the way, is, that it is a good help towards forming a diagnosis.

Encysted Tumours in the Vicinity of the Glandulæ Congregatæ and Lachrymal Ducts.—The difference between this and the last mentioned disease consists in the situation of the tumours. In the former the tumour is in the substance of the gland, and derives its fluid from it; in this disease the tumour is in the vicinity of the glandulæ congregatæ immediately behind the conjunctiva, and according to Schmidt it derives its fluid from the lachrymal ducts.

Symptoms.—The symptoms are by no means as severe as those mentioned in the preceding disease, and they exist but a short time before the tumour can be felt, which presents a circumscribed elastic swelling behind the upper eye-lid, and on its temporal side. As it enlarges it impedes the motions of the eye-ball particularly upwards and outwards, but if the eye-lid is taken hold of and raised from the eye-ball, the motions of the eye will be free; finally the cyst becomes so thin as to seem as if the

slightest touch would burst it. At no period of this disease is there much pain.

Treatment.—Beer recommended laying the cyst bare through the conjunctiva, then passing a seton of a thread of thick silk through the tumour, and thus obliterating the cavity of the cyst by exciting inflammation in it. But the treatment generally adopted at the present day, and the one I would recommend, is extirpation, and that as soon as the tumour can be felt.

True Lachrymal Fistula.—This is a callous fistulous opening, leading from the lachrymal gland through the upper eye-lid. The tears trickle through this opening, which is generally at the external canthus of the eye, and so small as with great difficulty, and even not at all, to be discovered by the naked eye.

Cause.—The cause of this disease is badly treated abscess of the upper eye-lid, orbital cellular membrane; or wounds of the lachrymal ducts.

Treatment.—The treatment consists, in producing inflammation in the fistulous canal, so as to get it to heal; and many modes have been recommended to accomplish this end. Beer in one case passed into the opening a red hot knitting needle, and turned it several times upon its axis. In five days afterwards the fistula was completely healed.

If the opening is large enough to admit the point of a small syringe, injections of the nitrate of silver will cure the disease. Another mode of treatment is to lay the sinus open, and then heal it by granulation.

Morbid Tears.—The following statement is made by Mr. Mackenzie: “The tears are at all times an irritating secretion; the conjunctiva is instantly reddened when they flow; and although we were to grant that this was consentaneous with the determination of blood to the lachrymal gland preceding the discharge, yet we observe that if the tears are so profuse as to run over on the cheek, the skin with which

they come in frequent contact becomes inflamed and excoriated.”

As well might Mr. Mackenzie have said that saliva was an irritating secretion, because if it was constantly running over the chin it would produce excoriation, or the discharge from the nose running over the upper lip would produce a similar effect. The simple fact is, that the part which those different secretions are meant to protect is mucous membrane, which will inflame if not kept moist, when the cuticle, or rather the true skin under it, not requiring any such provision, will inflame if kept moist by these secretions; indeed, simple water would do the same if kept constantly applied, for it is well known that the legs of raftsmen, and the arms of washerwomen are very red with scaly eruptions upon them. Mr. Mackenzie must have forgotten that in cases of epiphora, where the tear is constantly on the eye, very frequently the conjunctiva is not in the slightest degree inflamed. For my own part, I never saw a case of inflammation that I could attribute to the acidity of the tears, but at the same time I do not say that such may not sometimes be the case under peculiar circumstances.

Sanguineous Lachrymation.—This disease is one of which many authors doubt the existence, and as I have never seen it I shall make no comments, but give the following quotation from the work of Mr. Mackenzie:

“Dr. Clopton Havers relates the case of an ictorical discontented woman, who, having a desire to die, wholly rejected the help of medicine. Being well nigh her end, there appeared an eruption of blood out of the glandula lachrymalis of one of her eyes without any external injury; there was an evacuation of two pounds of blood within the space of thirty hours: about a week afterwards the same sluice was opened again, and she bled till she died.

“Professor Rosas refers us to a case of this sort related by Dodonaeus and to another by Lanzorei. In the former

instance the disease accompanied suppressed menstruation, in the latter it occurred in a lad of twelve years of age, who soon after died of malignant fever.

“ Professor Rosas himself witnessed the disease in a child of nine years of age, of scorbutic diathesis, and in whom it yielded to antiscorbutic treatment.

“ It is doubtful in all these cases, how far the discharge of blood was really from the lachrymal gland, and not from the conjunctiva.”

Lachrymal Calculus.—Calcareous deposits being found in the sinuses of the conjunctiva, their source has been attributed to the tears. Although cases of this sort are very rare, yet when they do occur it is wonderful with what rapidity the calculi form ; as great a number as thirty have been removed from the eye in twenty-four hours ; they resemble mortar, and their average size is something greater than the head of a pin. They are composed of carbonate and phosphate of lime, cemented with coagulable lymph or albumen.

Treatment.—It is unnecessary to say that those deposits act as foreign bodies, and if allowed to remain will invariably produce inflammation ; they therefore should be removed as fast as they are formed, but if possible their formation should be prevented altogether. As carbonate of potash was found so useful in calcareous affections of the kidneys, Walther prescribed it in this disease with the best effects, from which we may conclude that the best treatment in the former disease will be most successful in the latter, and I believe the best treatment is acids and, perhaps none comes before the nitric.

Extirpation of the Lachrymal Gland.—In this chapter I have frequently spoken of the necessity that sometimes arises for the removal of the lachrymal gland. I will now describe how this operation is to be performed.

There are two modes of doing it. The first is through the conjunctiva, the second through the upper lid; the former I consider the preferable mode. To remove it through the conjunctiva the upper lid should be everted by an assistant, and drawn outward from the eye-ball; but sometimes this is impossible, in consequence of the great size of the tumour; in which case an incision should be made from the external angle of the eye towards the temple; this incision may reach half an inch beyond the external angle of the orbit, and sufficiently deep to separate both lids at their external angle; it should go through integuments, muscle, and ligament; the reflected conjunctiva must then be cut through, after which there will be no difficulty in completely everting the upper lid, when the tumour will be brought into view: after it is exposed it may be taken hold of by a hook or forceps, dragged downwards and outwards, and then cautiously dissected out of the orbit, the operator taking care to leave no part of the gland behind. The eye-lid should then be restored to its natural position, and the edges of the wound carefully brought together with a few stitches and adhesive plaster. A compress and bandage should be next applied, and the patient ordered to remain quiet. The second mode of operating is to make an incision through the upper lid, external to the conjunctiva, and parallel to the fibres of the orbicularis muscle, along the upper edge of the orbit. When the tumour is thus exposed, it is to be removed in the mode already detailed, and the after treatment is the same.

The objection I have to this last operation, is the difficulty of making the wound of sufficient size, and also the difficulty, anatomically speaking, of getting at the gland from this part: however, the size of the tumour, with the extent of injury in the surrounding parts, must guide the surgeon as to which mode of operating he should adopt in each individual case.

CHAPTER XIII.

DISEASES OF THE EXCRETING LACHRYMAL ORGANS.

Acute Dacryocystitis.—By this term is meant acute inflammation of the excreting lachrymal organs, in contradistinction to a chronic form, which will be explained in the next article.

Symptoms.—Redness and a hot itching pain at the internal angle of the eye, which soon extend into the side of the nose ; there next appears a small round tumour over the lachrymal sac, which is hard to the touch ; then the inflammation is seen to extend along the palpebral conjunctiva, the lower lid being first attacked, and afterwards the upper ; if at this stage the puncta are examined, they will be found contracted ; as the disease advances, the tumour over the sac increases in size, and becomes red, and so tender that the slightest touch will produce the most acute pain ; the eye-lids and cheek next become so swollen and red, that the eye-ball is nearly concealed, but if visible the conjunctiva will be seen to have partaken of the inflammation. When the lachrymal passages become obstructed stillicidum lachrymarium supervenes ; the red phlegmonous swelling changes its color, and becomes of a purplish appearance ; the matter is now felt to fluctuate, and if it be not discharged through the nasal duct or puncta, which is a very unusual termination, the skin covering the abscess will slough, or the abscess will point and burst, below the tendo oculi ; the discharge will be puriform mucus, and as previous to bursting some of this matter will have found its way between the muscle and integuments, though the discharge may be of great quantity, yet all the swelling will not be

removed. After the discharge has continued for some time, its character changes, and tears mixed with pus are discharged, which in time again changes, and pure mucus is discharged instead; this matter becomes thinner, and finally the sac heals, either leaving the nasal duct impervious, or the parts in their natural state.

The constitutional symptoms in this disease are sometimes very severe, head-ache, fever; and the second stage is often accompanied with delirium. It commences with inflammation of the mucous membrane lining the lachrymal passages; the first effect of which is a suppression of the secretions, and the second an increase of mucus secretion; the outlets of the nasal duct and sac being obstructed or obliterated by inflammation, the mucus collects in the sac, which from its lying upon a bony surface, appears as a tumour very early in the disease; suppuration next sets in, and follows the course already detailed.

Causes.—The only causes that can be assigned are, cold wind blowing on the side of the face, or some mechanical injury.

Prognosis.—During the first stage, if the patient is of a healthy constitution, and not tainted with scrofula, scorbutica, or syphilis, the prognosis may be favorable, but when once the second or suppurative stage has commenced, the great probability is that it will terminate in some part of the canal becoming obstructed.

Treatment.—In the first stage every effort must be made to subdue the inflammation, by antiphlogistic means, such as local bleeding, purging, nauseants, diaphoretics, and cold or hot evaporating lotions of the acetum plumbi applied to the parts. In the second stage the matter should be at once evacuated by a puncture of the lancet, after which the sac should be well washed out by means of a syringe and warm water; this treatment should be continued, with emollient poultices, for a few days; it will be also

necessary to examine the nasal duct with a probe, to see if it be pervious ; after syringing and poulticing for a few days, simple dressing may be used, under which the parts generally heal in a short time, without further trouble ; however, it is sometimes necessary to excite the sac with stimulating injections, before it can be made to heal ; and after this is effected, to correct the secretions a drop of the six grain solution of the nitrate of silver may be dropped into the internal canthus of the eye, once or twice a day.

Chronic Dacryocystitis or Chronic Inflammation of the Excreting Lachrymal Organs.—This is a more frequent disease than the acute form, and much more difficult of cure ; indeed very frequently every effort to cure will be found unavailing, unless a patient having to wear a style in the nasal duct all his life, can be said to be cured. It is said to be more frequent in women than men ; I have not found this to be the case. It will attack persons of all ages.

Symptoms.—The first thing the patient complains of is being constantly annoyed by having repeatedly to wipe away the tears which collect in the internal canthus of the eye, more particularly if the weather be damp or cold. If the eye be examined at this period, the redness of the parts is so trifling that it is only observable when compared with the sound eye, and then the only parts that appear a little inflamed are the puncta and *carruncula lachrymalis*. After some time the patient discovers that by pressing his finger on the internal canthus of the eye, he can force the tears down into the nose, or cause them to regurgitate through the puncta. This may go on for years before the second stage, which is called *blenorrhœa*, sets in ; then there is pain, redness and swelling at the inner canthus, which when pressed upon, forces the tears back on the eye, mixed with mucus, or down into the nose : as the disease advances, the tears cease altogether to pass into the nose, but always regurgitate on the eye. This constantly occurs

spontaneously, through the action of the orbicularis muscle ; at this period there is a dryness of the nares on the affected side, from the want of tears passing into it. If then the conjunctiva of the lower lid be examined, it and the meibomian glands will be found inflamed, and not unfrequently the skin of the cheek will be excoriated by the muciform fluid dripping over it. Repeated attacks of inflammation will now take place in the sac, terminating in suppuration, so that where mucus only had existed there will be pus formed, and the integuments over the sac will become inflamed, red, and extended. Finally, the sac points like an abscess, and bursts, discharging a muco-purulent fluid ; and, as, at this stage of the disease, there is obstruction of the nasal duct, either from adhesion of its sides or thickening of the membrane, the opening thus made will continue to pour out pus mingled with tears, and thereby form a fistulous opening ; and if the opening be not in a proper position to favour the free exit of the discharge, it will burrow under the integuments, and perhaps form two or three additional fistulous openings. If a probe be passed into any of these openings, the surgeon is very likely to find caries of the bone, particularly if the patient be scrofulous or tainted with syphilis.

Causes.—The causes of this disease may be either local or constitutional, but, generally speaking, the latter are the most frequent. The local causes may be injury or congenital smallness of the nasal duct ; the constitutional causes may be a scrofulous diathesis, natural weakness of the constitution, syphilis, small pox, measles, scarlet fever, teething, worms, or a disordered state of the digestive organs.

Prognosis.—The cure of such a case, without an operation, is always doubtful, even under the most favorable circumstances ; nevertheless I have frequently succeeded in curing it in the second stage without an operation, but when the third stage has set in, any means without operation are not only useless, but sure to increase the evil.

Treatment.—Numerous as the causes are which produce this disease, yet there is no difference in the local treatment to be pursued; constitutional treatment is only useful in the first and second stages, and it must be adapted to the condition of the patient's health. In the first stage, or watery eye, the state of the constitution should be carefully enquired into; if the digestive organs are found deranged, an emetic and purgative, with some astringent lotion to the eye, may at once cure the disease; gentle alteratives may also be found useful. If the habit be scrofulous, syphilitic, or scorbutic, medicines that are known to correct such morbid states of the system must be given. Local treatment must be directed towards reducing the inflammation, which is the cause of the flow of mucus and tears; therefore it must be antiphlogistic; leeches should be applied to the sac, as well as evaporating lotions of the acetate of lead, and in addition an astringent lotion should be dropped into the internal canthus of the eye once or twice a day, to be taken up by the puncta, carried into the sac, and there correct the nature of the secretion. The best lotion is the saturated solution of the acetate of lead; but before it is used, the sac should be well cleared out, and when the drop is put into the eye, it should be allowed to remain there, with the patient's head thrown back, for eight or ten minutes, making him at the same time respire strongly and frequently, through the affected side of the nose. The secretions of the meibomian follicles and glands should also be corrected, and this is best done by smearing on the edge and inside of the lower lid, every night at bed time, a small portion of ointment, composed of equal parts of the citrine ointment and the ophthalmic ointment of Jannin.*

*Jannin's ophthalmic ointment :

℞ Bol. armen. ʒii
 Tutisæ prep ʒii
 Hydr precip. albi. ʒi
 Axungia ʒi mt.
 ft. Unguentum.

The constitutional treatment that is adopted in the first stage, will be also necessary in the second. It is astonishing what efficacy a simple constitutional treatment will sometimes have in removing this disease, even in the second stage. I remember, about nine years ago, a lady consulted me for this disease; I found it in the second stage; when the sac was pressed upon, the whole of the eye was immediately covered with mingled mucus and tears; she told me, that the tears had been annoying her for about eight months, but that the matter had only appeared, about four or five days previously; seeing some anasarca swelling about the eye-lids, I ordered her a purge of the compound powder of jalap, to be followed by a teacup-full of cream of tartar water, two or three times a day. In four or five days, the disease entirely disappeared and has never since returned. The lady's age at that time was about 48.

If during the progress of the disease, the nasal duct becomes obstructed, or if obstruction be the original cause of the disease, no cure can take place unless this condition be removed. To accomplish this, many plans of treatment have been recommended, some of which have succeeded at one time and failed at another. If the cause is a collection of mucus; stopping the mouth and nose, and giving a forced inspiration, very frequently succeed in removing it, and where this does succeed, it should be constantly done during the day. Sternutatories have been recommended in such cases, but I have never seen any benefit to be derived from their use. If it arise from a collapsed state of the mucous membrane, or from a morbid condition of the ophthalmic branch of the fifth pair of nerves, it will be generally found to be accompanied with amaurotic symptoms, such as a dilated pupil with sluggish action. Along with other means, in such a case, electricity, and counter-irritation, by means of blisters before the ear, will be found very useful. If the cause of the obstruction be a spasmodic contraction of

the duct, from any irritation of the fifth nerve, smearing the outside of the sac with the extract of belladonna, and inhaling through the nose, warm camphorated fumigations, may be found serviceable, and a smart purge of croton-oil will also help to allay the irritability of the nerve. Anel recommended, in all cases of obstruction of the duct, that it should be opened by passing a small gold or silver probe through the puncta down into the nose. For this purpose, he invented six different sized probes, varying from $\frac{1}{8}$ to $\frac{1}{10}$ of an inch in thickness; they are round and smooth, but not bulbous at their extremity. He recommended that one of these probes should be passed every day, and after their withdrawal, the passage to be injected through the puncta, by means of a syringe, which he also invented, and which bears his name. Of this treatment I can only say, that although I have found it succeed occasionally in incipient cases, I have much oftener found it to fail. When a student, I have heard Dr. Jacob of Dublin more than once, not only pronounce it a useless, but an injurious mode of treatment, as the use of either the probe or syringe would be likely to split the puncta, or tear and disorganize the mucous membrane. The following statement is made by Mr. Mackenzie: "I have occasionally succeeded in completely curing slight incipient cases by injections with Anel's syringe, but much more frequently I have failed."

If the puncta be obstructed with mucus, removing the mucus with a small probe will certainly be correct; but if the puncta cease to perform their office, I do not see how either probes or injections will restore their action; and if the obstruction be in the nasal duct, a probe that would pass through the punctum would hardly remove it.

The following is the mode of using Anel's probes and syringe: The eye-lid is to be put on the stretch, by drawing it with the fingers of one hand towards the temple, the edge of the lid being drawn at the same time a little for-

ward, so as to bring the punctum into view ; the probe being now held in the other hand, its point is to be carefully inserted into the punctum, (I speak of the upper lid), and then pushed upwards, and inwards towards the nose, until it reaches the angle of the canal, when the hand holding the probe must be turned upwards, so as to bring the point of the probe obliquely downwards and inwards, the lid at the same time being drawn with the hand which holds it, upwards and outwards ; the probe may then be pressed downwards, a little outwards and backwards in the direction of the nasal duct, till it strikes the floor of the nostril. If the probe is passed into the inferior punctum, it must be introduced perpendicularly from above, downwards ; the handle of the probe is then to be lowered to a horizontal position, then pushed into the sac ; when the point strikes the side of the nose it should be a little withdrawn to prevent its being entangled in the mucous membrane ; it may then be turned in the direction of the nasal duct, and the operation proceeded with as already described. If the nasal duct is found free, the surgeon, after withdrawing the probe, may use the syringe by introducing its point into the punctum, in the same manner that he did the probe. The syringe being previously charged with tepid water, its piston should be slowly pressed down, when the water will be found to run down into the throat. But if the nasal duct is obstructed, the water will not run down, but remain in, and distend the sac, when the surgeon must endeavour, by pressing on it with his finger, to force it down the nasal duct, and if this cannot be done, it must be regurgitated through the puncta. After the water passes down the duct, stimulating injections may be used in the same way, the best lotion being the saturated solution of the acetate of lead. Laforest recommended probes to be introduced into the nasal duct from the nostril, and from the same part injections to be thrown into the sac. However, from the difficulty of introducing a probe in this way, the practice is now abandoned.

When all the above methods have failed, the only thing that remains to be done, is to make an opening into the sac, and dilate the duct by mechanical means. Different mechanical means have been recommended, such as styles, tubes, bougies. Ware recommended the style—Dupuytren, the tube—and Pott, the bougie; in the present day the silver nail-headed style, of Ware, is what is generally used. Mr. Mackenzie, Dr. Jacob, (unless he has altered his opinion since I was a student under him,) and Mr. Liston, all recommended it. As a general rule I give it the preference, but in young subjects I adhere to Beer's plan of treatment, which is as follows :

There being an opening into the sac through the integuments, either spontaneously formed or made by the knife of the surgeon, a piece of cat-gut, of the ordinary length and size of a small fiddle-string, is passed through the duct into the nose, one extremity is brought out through the anterior nares, and fixed to the ala nasi by means of a piece of adhesive plaster, and the other secured to the eye-brow by a turn or two of a bandage. Every day a fresh portion of the cat-gut is drawn through the duct, until several sizes have been made to pass; when the cure is considered complete, the gut is withdrawn, and the external opening allowed to heal. The only difference I have ever made in this mode of treatment, is, instead of forcing the obstructed duct, in the first instance, with the cat-gut, I do it with the probe, and in addition to keeping the duct dilated with the cat-gut, I syringe the duct every morning with warm water, and afterwards with a two or three grain solution of nitrate of silver; as soon, however, as the discharge becomes healthy, I only drop the nitrate of silver solution into the internal canthus of the eye, and allow it to remain till it is taken up by the puncta. One great advantage from the cat-gut is, that being put into the duct in a dry state, it very soon becomes moist, and swells to nearly double its original size,

and from being so soft cannot possibly injure the mucous membrane as much as a metallic style. Doctor Paraish, one of the surgeons to Wills' Hospital, revived the practice of Pott on an improved plan, which treatment he speaks of with confidence. He recommends, if there be a fistulous opening, to have the inflammation surrounding it removed by means of emollient poultices; then to introduce a small piece of wax bougie, having an acute point, down to the strictured part of the duct; its blunt end is then to be secured to the forehead with a strip of adhesive plaster. In one or two days the bougie is to be removed, the parts washed out, and a similar bougie of a larger size to be inserted in the same way. He says by persevering in this plan, an advance will be made from day to day upon the strictured surface, until at length a bougie can be passed through the whole extent of the canal. This plan of dilatation should be continued until the bougie pass freely and until all hardness and inflammation have disappeared from around the fistulous orifice; after this has been accomplished, the use of the bougie may be discontinued, and the external opening allowed to heal, which it usually does in a short time under simple dressing. He recommends the surgeon to make the bougies himself, by dipping a piece of fine linen into white wax in a melted state, then suddenly withdrawing the linen and allowing it to cool: a strip is then to be cut off and rolled tight to whatever size the bougie may be required. He says his reasons for this mode of treatment are, that by this process the canal is gradually dilated, and its mucous surface restored to its natural condition, without doing violence to the parts, while the duct is placed in a state to resume its natural functions, without the necessity of permanent dilatation. He recommends, if there should be a disposition to relapse after the external orifice has healed, to endeavour to counteract it by the use of stimulating ointments applied to the inner surface of the lids, or by astringent washes. I

have used these bougies very frequently as a substitute for a silver style, when the latter has produced irritation, and have derived the greatest benefit from them; I have not, however, used them to relieve the stricture in the way recommended above.

When the surgeon is satisfied that he cannot remove the obstruction of the nasal duct without mechanical means, and he determines on using them, if there be not an opening already into the sac, he must make one, after which he is to discharge its contents, and wash it out; then taking a common probe, he is to direct it into the sac, in a horizontal position, till it strikes the nasal side of the sac; the hand is then to be turned upwards, and the probe pushed downwards, and a little backwards and outwards, into the nasal duct till it enters the nose, below the inferior spongy bone. If there be no stricture in the duct, the probe will slide easily into the nose, but sometimes it will require a steady pressure to be kept up for some time, in order to remove the stricture, and, more than once, I have found the probe obstructed in its passage, two or three different times. Indeed, in some cases I have found it necessary to withdraw the probe, and pass a small bistoury down into the duct, to relieve the stricture. After the duct is opened, the probe should be at once replaced by whatever mechanical means the surgeon intends to employ, but if the case is not such as heretofore mentioned, I would recommend the nail-headed style, it being first passed through a small piece of court-plaster, of sufficient size to cover the external wound, so as to prevent the head of the style from slipping into the sac, and also to favor the healing of the external wound, so that no part shall remain open except the space occupied by the style. Every day for four or five days in succession, the style should be partially withdrawn, and the duct syringed out with warm water, after which an astringent lotion should be used. As those styles are made of either

gold or silver, they will corrode if the patient does not take them out, and wash them clean, at least every second day ; after a little practice the patient will find it no trouble to replace the style. I have seen Dr. Jacob when performing this operation, instead of withdrawing the probe, and replacing it with a style, bend down the probe, and cut it off with a bone forceps, leaving in the duct a hooked head style. When a tube is used instead of a style its head is pushed under the skin, and the parts allowed to heal over it ; however, after some time the tube acts as a foreign body, and the parts become inflamed, so that it has to be removed, which is sometimes very difficult to perform.

Styles and tubes are of different lengths and thicknesses, the greatest length being one inch and a quarter, and the greatest thickness $\frac{1}{20}$ th of an inch. The use of the style is to conduct the tears, when collected in the sac, into the nose, the tube is for the same purpose, although it carries the tears in a different way, but its good effect is often counteracted by the funnel becoming plugged up with mucus ; thus there are many reasons why the style should be preferred.

Different modes of opening the sac to get a probe into the duct have been practised. Sir A. Cooper recommended that it should be done with a phymosis knife, after which a blunt pointed bistoury is passed down into the duct, to remove the obstruction : other operators simply open the sac with a lancet, and then pass down the probe. Owing to the difficulty there is sometimes found in getting the probe into the sac, the late Mr. Liston recommended the opening to be made into the sac, with a narrow bistoury, which should at the same time be lodged in the canal ; and while withdrawing it, the probe to be passed down. The following are his words :—

“ Knowing the direction of the canal, you put your knife behind the margin of the bone ; behind the nasal process of the superior maxilla, push it down at once, and lodge it

fairly in the canal. In that way you are in a position to make the passages pervious. If you follow the knife with a probe, withdrawing the knife while you introduce the blunt instrument, you come at once into the nose, and there will possibly be some slight flow of blood from the nostril; If after a few days, you close the nostril and make the patient respire forcibly, the blood and matter will be thrown up into the corner of the eye, and then you are sure that you have properly effected your object." These remarks of Mr. Liston refer to the case of a fistulous opening from the cheek to the sac, but I believe them equally applicable where there is no fistulous opening, and we want to get a style into the nasal duct; and I must say, of all other modes of performing this operation, that I have ever heard of, I consider Mr. Liston's the best, and always practise it.

Fistula Lachrymalis.—There are many cases of the two preceding diseases,—*chronic* and *acute dacryocystitis*, that do not come under the surgeon's notice until an abscess of the sac has formed and burst, leaving a fistulous communication between the sac and the cheek. To this state of the disease, the term *fistula lachrymalis* is applied, and as it has been so often alluded to in the two preceding articles, there remains but little more to be said on the subject. In such a case the opening must be enlarged with the knife, before any attempt is made to pass a probe into the duct: as soon as a style is inserted, a poultice should be applied to the parts, and renewed frequently for a few days, until the hardness round the edge of the fistulous opening disappears. If there is any other fistulous opening, it should be laid open, (if superficial) and allowed to heal by granulation, which can be accomplished by simple dressing. But if the fistula be deeply seated, a probe should be passed into it, and the end of the probe cut down upon so as to form a counter opening, when the fistulous canal can be healed

by syringing it with a lotion of the nitrate of silver or *vinum opii*, either of which should be used daily; poultices should be also applied until the hardness and swelling disappear, then a compress and bandage applied.

There are some cases, where the style may be removed, and the external opening allowed to heal up after a few months, in other cases not for as many years, and others again where the style can never be dispensed with. But if at any time, the surgeon is satisfied of the effectiveness of the nasal duct, he may remove the style, and allow the opening to heal up. But if before using the style, there had been a fistulous opening from the sac to the external parts it may not very readily heal up after the style has been removed; by touching it, however, from time to time with the nitrate of silver, the surgeon will generally succeed in getting it to heal, but if not, the edge of the orifice must be made raw with a lancet, and then drawn together with adhesive plaster, or if necessary a stitch.

It not unusually happens, that when there is a fistulous opening, if the surgeon passes a probe into it, he will find caries of the bones in connection with the canal: here an operation is of no use, and as to putting a style among a lot of rotten bones, it is worse than useless. In such a case he must attend particularly to the general health, and state of constitution, which will be generally found tainted with scrofula or syphilis, when such medicines as possess control over these cachexiæ must be given.

In either case change of air will be found of great benefit. The local treatment must be directed towards correcting the chronic blenorrhœal discharge, repressing the tendency to fungus, and improving the condition of the bones. Injections of weak solutions of nitrate of silver will be the best local treatment, and if a fungus should appear, it must be kept down by touching it occasionally with the pure nitrate of silver.

When the surgeon is about to operate for fistula lachrymalis, or to remove an obstruction of the nasal duct by operation, there are some cautions to be observed,—First, he should be sure not to make the puncture anterior to the nasal process of the superior maxillary bone, instead of posterior to it: this may appear a very useless warning, but I have known it done more than once by surgeons who held no mean opinion of their acquirements, and moreover after making such a puncture, force a probe down between the muscles and the bone, and wonder why they could not feel the probe in the nose: of course, such treatment will always be followed by severe inflammation and suppuration. The surgeon should take care not to cut the tendon of the orbicularis palpebrarum muscle, which, though easily seen in chronic dacryocystitis, cannot be felt at all, when the parts become swollen and inflamed, the state in which the surgeon generally sees it; so he must depend upon his anatomical knowledge of the parts, as he may not be able to feel the edge of the orbit to guide him. He must also remember, that the parietes of the nasal fossa and duct are so thin, that if the knife or lancet which opens the sac be pushed hard against them, the bone will be broken; even the probe, if directed too much backwards, will penetrate the æthmoid bone, and be lodged in the nose, above, instead of below the inferior spungy bone, and consequently it will not pass through the duct at all. The next and last thing for the surgeon to attend to, is to have a style of a proper size; it should not fit too tightly nor yet too loosely, but with exactness. In regulating its length the rule should be, that while the head merely appears at the corner of the eye, its point should approach, but on no account *rest* upon the floor of the nostril.

The following case of acute inflammation setting in, where chronic dacryocystitis had existed for four years, I

consider interesting, from the fact of the treatment of the acute inflammation having cured the original disease :

October 27, 1846.—R. P., Esq., aged 33, called upon me to treat him for disease of his eye. He told me that for four years he had been annoyed with water collecting in his eye, and that when he pressed his finger on the side of his nose near the corner of his eye, matter and tears used to gush out, and nearly blind him. That four days previous to the time I saw him, he found a small hard tumour form, where he used to press his finger, since which time he said that he suffered most agonizing pain in the whole side of his face and head. He was travelling all the night, previous to his calling on me. When I saw him the tumour fluctuated, the whole of the lower lid was swollen and purple, the side of the cheek presenting an erysipelatous, appearance.—In three days afterwards he was perfectly well, and the old disease completely removed. The following mode of treatment was adopted in this case :—I made a free opening with a lancet into the sac, and discharged a great quantity of muco-purulent matter. I then passed a piece of cat-gut down the nasal duct, which I again withdrew, and washed the sac and duct out with a syringe and warm water : I then applied a warm poultice all over the part, first putting a tent into the wound to keep it open. The next day the swelling had entirely disappeared, and the small quantity of matter secreted proved quite healthy : I removed the tent, and dressed the part with a little simple dressing ; on the third day the wound was healed, after which all went on well.

Mucocele of the Sac, (or the Hydrops Sacci Lachrymalis of Beer.)—This disease is a tumour of the lachrymal sac, caused by the sac, becoming distended with mucus, which mucus is secreted from its lining membrane, and kept pent up in the sack by the obstruction of the lachrymal canals and nasal duct. In such cases the sac cannot be emptied

by the strongest pressure, which circumstance, together with the hardness and purplish color of the swelling, form the characteristic symptoms of the disease. This tumour sometimes becomes as large as a pigeon's egg, but there is no pain felt until it appears as if about to burst, which it is not likely to do for years. The disease, from its commencement, is accompanied with *stillicidium lachrymarium*.

Treatment.—A free incision must be made into the tumour, and the sac laid open, out of which the collected mucus is to be removed, which is sometimes so inspissated as to resist water and a syringe, and will require to be removed by a forceps; the nasal and lachrymal ducts should be then examined, and, if found obstructed, their impeding matter to be gradually removed, until they are found to convey the tears. The wound in the sac should be prevented from healing, by a tent being kept in it. If when the sac is opened, it is found greatly enlarged, a part of it should be excised with the scissors; when the tears are found to run into their proper channel, the external wound may be allowed to heal.

Relaxation of the Sac, (Hernia Sacci Lachrymalis of Beer.)—In this case there is also a tumour at the corner of the eye, or side of the nose, of about the size of a horse bean, or less; the color of the integuments covering it is natural; it is soft, and yields to pressure, while its contents are readily discharged through the puncta or nasal duct. This tumour is formed by the relaxation of the sac, which from having been over distended with either pus or puriform mucus, loses its contracting power and elasticity. The sac sometimes becomes ruptured, and when this happens the skin covering it is folded round the parts, and has a flabby appearance.

Treatment.—Beer found these cases curable by compression of the sac; the application, however, of stimulating and astringent fluids to the internal part of it, and also to the integuments covering it, does much towards hastening a

cure. Many astringents might be mentioned, some answering better in one case than in another : but perhaps, as a general rule, there is none better than the saturated solution of acetate of lead ; which may be dropped into the internal canthus of the eye once or twice a day, and allowed to remain there, with the patient's head thrown back for five or ten minutes, until the puncta have time to absorb it. The same lotion diluted, may be applied to the integuments covering the tumour. The surgeon must use his own ingenuity as to the means he will employ in exerting pressure upon the tumour ; the mode recommended by Mr. Mackenzie, is one of the best, and has the advantage of being very simple, and is easily applied. The following quotation will explain it :—" Graduated compresses then are to be preferred : over these a firm leather pad of a proper form is to be placed, and the whole is to be supported by a narrow roller passing round the head."

Polypus of the Sac.—Where a polypus forms in the lachrymal sac, the nature of the tumour cannot be known until the sac is opened. The cure will be completely effected, after it is discovered, by taking hold of the growth with a pair of hooked forceps, and twisting it out.

Calculi in the Excreting Lachrymal Passages.—When calcareous deposits are found in either the lachrymal or nasal ducts they should be removed. The constitutional treatment will be the same as that recommended in the preceding chapter, under the head of "Lachrymal Calculus."

Obstruction of the Puncta Lachrymalia and Canals.—One particular symptom of these parts being obstructed, is, of course, stillicidium lachrymarum. As there are different causes, so there are different modes of treatment. If there be congenital abscess of these parts, the case is incurable ;*

* The following statement is made in the Dublin Quarterly Journal of Medical Science for May 1848. "A case of the congenital absence of the four puncta in a barrister in Paris, aged 25, has been related by Mr. Blanchet, who has succeeded in establishing a punctum in communication with the lachrymal duct upon the right side.—*Gazette Medicale for 1st May, 1847.*"

if the puncta and canals are closed by adhesion, as the result of inflammation, it will be equally so. If the cause has been a wound of the duct which has not united so as to leave the canal pervious, it will also be incurable. If the puncta and canals be simply stopped up with mucus, one of Anel's probes will easily remove the obstruction, after which may be dropped into the puncta, twice a day, a solution of the nitrate of silver. If only a small part of the duct be obstructed by adhesion, the probe may be pushed through it, and the obstruction will be thus removed, after which the probe should be passed daily for some time into the duct, it being previously smeared with any mild ointment; tumefaction of the mucous membrane lining the canal may obstruct the passage, nevertheless as the tumefaction is only a symptom of the inflammation, it must be obvious that by subduing the latter the obstruction will be removed.

Relaxation of the Puncta and Canals.—In this disease the puncta are wide open, and do not contract when touched, as in the healthy state: as some of the tears find their way into their natural channel, there is only partial dryness of the nostril, and partial stillicidum lachrymarum. The puncta being turned out, do not touch the eye-ball.

Causes.—Erysipelatous inflammation of the eye-lids or any of the purulent ophthalmias may cause this disease.

Treatment.—Stimulating lotions dropped into the internal canthus of the eye once or twice a day; Beer recommends a solution of the sulphate of iron, to which a small quantity of camphorated spirit or tincture of opium has been added. There is nothing preferable to the vinum opii.

Injuries of the Excreting Lachrymal Organs.—These parts are exposed to every species of mechanical and chemical injuries: wounds of them may be either incised or lacerated. The puncta, in unskilful hands, are constantly being split, by the use of Anel's probes. Loose eye-lashes have been

known to get into the puncta. The sequel of lacerated wounds in those parts are inflammation and suppuration, terminating in adhesion of the canals. When one of the canals is cut across by an incised wound, it is very difficult to heal it so as to prevent obstruction. The most approved method is to keep a *bristle* in the canal during the healing of the wound. Every effort should be made to heal it by the first intention. The sac may be opened by an incised or lacerated wound; in either case care must be taken lest in healing it should degenerate into a fistulous opening. Mr. Mackenzie says, "a blow over the sac will sometimes rupture it without the skin being divided, and emphysema of the eyelid will ensue on blowing the nose." Severe blows may break the bones of the nose, and obliterate the nasal canal. I think in such a case, it would not be bad practice to open the sac, and keep a style in the canal until the parts heal. A short time since, I operated upon a boy for chronic dacryocystitis; when I had got the probe about half-way down the canal, I found the remaining part so completely obliterated, that I was compelled to drill a hole through it; I afterwards learned that five years before, the boy had his nose broken by the kick of a horse, from which time the tears used to run over his cheek.

When any affection of the lachrymal organs renders it necessary to use a stimulating lotion, I usually prefer the saturated solution of the acetate of lead, or that recommended by Beer, which is made as follows:—

℞ Subacetatis cupri, potassæ nitratis, aluminis aa gr iii—vi, camphoræ tritæ gr ii—iv, aquæ distillatæ ℥ss; solve et cola: liquori colato adde vini opii ʒi—ʒii; aquæ rosæ ʒiv M. Professor Beer made a mass of the three first articles, melted together in equal proportions, which he terms the *lapis divinus*. Of this mass, he made the lotion, and then added the other ingredients. When stimulating ointments are required, I prefer Janin's, either diluted or of full strength to any other ointment.

CHAPTER XIV.

INJURIES AND DISEASES OF THE MUSCLES OF THE EYE-BALL.

Injuries.—The muscles of the eye-ball, from their position, are not very liable to be injured, indeed they cannot suffer without other parts being implicated. To discover if one of the muscles of the eye-ball be wounded or lacerated, is a very difficult matter, but the diagnosis is here of little consequence, since the treatment will be the same as that pursued in injury done to any other parts within the orbit, viz :—soothing applications to the part, and general anti-phlogistic treatment.

Paralysis of the Muscles of the Eye.—That the six muscles of the eye-ball may be paralyzed at one and the same time, is by no means an impossible occurrence. But such cases must be very rare, as I have never read of any one seeing it, except Sir. C. Bell, who only witnessed it once. In such a case there is paralysis of the nerves that supply them with motor power, viz :—the third, fourth and sixth. The eye will be fixed, motionless, and in some degree protruded ; it is very probable that the iris will also be motionless and dilated, causing partial amaurosis. And it is equally probable, that the same cause which produces paralysis of those parts, will also operate similarly upon the fifth and optic nerves ; we may also expect that the constitutional symptoms will be, derangement of the bowels and stomach, with vertigo.

Causes.—I know of no causes that could produce such an effect, except some disordered state of the brain, or some tumour growing in the back of the orbit.

Treatment.—If a tumour should exist in the orbit it must be removed ; if there be not, I would recommend the treatment to be directed to the brain.

Strabismus.—By the term strabismus, or squint, is meant, that distorted state of one or both eyes, in which the axis of vision is displaced by the involuntary diverging or converging of one or both eyes. If the eye be turned inwards it is called convergent strabismus; if outwards, divergent strabismus. Much has been written upon this subject since the years 1838 and 1839, the period at which the operation for its cure came so much into vogue. This operation is called myotomy or tenotomy. Stromeyer was the first to recommend it, but it was Diefenbach who proved its advantages.

In the year 1841, I first saw the operation performed by my friend Dr. Wilde of Dublin, who is now an oculist of noted repute for his tact, judgment, and skill in that branch of the profession. It was he who kindly provided me with the requisite instruments for performing the operation when I was about to leave Ireland.

Symptoms.—In all cases of strabismus, both eyes are more or less affected, although the deformity of one is usually so conspicuous as to cause no notice to be taken of the other. A person with strabismus always looks at objects with but one eye at a time. If one eye is much worse than the other, the person when reading will hold the book in the usual position before both: but he uses at the same time only the best eye, and leaves the other idle. But if both eyes are similarly affected, the book will be held to one side, and the patient will read with the eye farthest removed from the page on the opposite side, that is if the strabismus be convergent. But if it is divergent strabismus, then the eye that is used is that on the side the book is held on,—that is to say, if a person with convergent strabismus, of both eyes, reads with the right eye, he holds the book to the left side, and if with the left eye to the right side; but in divergent strabismus the book is held on the same side as the eye with which he reads.

If in strabismus the best eye be hoodwinked, then the bad eye becomes straight, but the patient finds that it is weak, and that he cannot see objects with it as well as with the other eye : if the blind be removed, and the good eye suddenly exposed, it will be seen to be very crooked, but it soon acquires its usual position, and the other becomes again distorted. Convergent strabismus is more frequent than divergent—I have found the average to be about six cases in ten. In all cases of strabismus the person afflicted has defective sight to a greater or less extent.

Causes.—The direct causes for strabismus, or squint, are only two, viz. :—contraction of the rectus muscle on the side to which the eye is turned, or paralysis of the opposite rectus (*Luscitās*.)

The remote causes are many. When the disease occurs in childhood, which it generally does, I think that, as a general rule, what first takes place is *luscitās* or paralysis of one of the muscles, then its antagonist draws the eye over, and although the paralysed muscle may in time recover its tone, still it does not regain sufficient strength to restore the eye to its natural position, against the heretofore unopposed action of its healthy antagonist. In this state of things years pass over, and although the paralysed muscle may have regained its full power, still the other having been so long permanently contracted, continues so. Again, the cause at the first, may be spasm of the muscle on the side to which the eye is turned, which keeps the fibres of its antagonist so much upon the stretch as to deprive it of its full power of contraction, even after the spasmodic state of the muscle has ceased to exist.

The remote causes are intestinal and cerebral derangement, produced by teething, indigestible food, worms, &c. Habit is another cause ; mimicking others ; constantly looking at a speck, such as a mole or wart on the side of the nose, or a curl of hair hanging at the side of the eye, are

not unusual causes. In this way one muscle being employed more than its antagonist, becomes more powerful, according to a well known physiological law, and retains it by becoming contracted. In the same way it is produced in children who, suffering from scrofulous ophthalmia, acquire the habit of looking side-ways. An opacity of the cornea in the axis of vision, paralysis of the retina in the axis of vision, or an artificial pupil in the side of the iris; any of these will act as a cause; for the person habitually turning the eye aside, and thus from habit, the muscle at length becomes contracted.

Diagnosis.—It does not require a man to be a surgeon to ascertain that a person squints, and whether the squint is convergent or divergent, but it is not always so easy to know the actual cause of the disease: in other words to diagnose between true strabismus and luscitas. The best way to discriminate between these two varieties of the disease is as follows:—If, for example, in a case of convergent strabismus, when the better eye is shut, the patient exercises no power over the external rectus in drawing the eye outwards, but when told to do so turns it upwards and downwards, then the surgeon may be pretty well satisfied that the case is paralysis of the external rectus; if, on the contrary, he can draw the eye partially outwards, but not completely so, then he may conclude that there is contraction of the internal rectus. If the patient, under the above circumstances, shows that he has full power over the weaker eye, then the probability is, that it is dependent upon some affection of the retina, except there be an opacity of the cornea or artificial pupil, which will at once lead to the cause.

Prognosis.—There are so many remote causes to produce strabismus, that a prognosis must always be cautiously given. However, if the surgeon be perfectly convinced that he has nothing to contend with, but a contraction of the muscle, he is justified in promising that, if all other treat-

ments fail, the operation of myotomy will prove successful. But at the same time the patient should be informed that after one eye has been operated upon, it is possible the other may require the same treatment.

Treatment.—The treatment will depend upon both the direct and remote causes. If the direct cause be contraction of the muscle from habit, let the habit, if possible, be interrupted; for instance, if it arise from an opacity of the cornea, or paralysis of a part of the retina, let these be removed, and the strabismus will soon disappear; if from artificial pupil on the side of the iris, the case should not be interfered with.

If an operation be attempted where there is either opacity of the cornea, paralysis of a part of the retina, or artificial pupil in the side of the iris, matters are made much worse, but fortunately the operation cannot succeed, for if it did, it would deprive the patient of the only source of vision he possessed, strabismus in such cases, being the work of nature to give the patient all the light possible. When in a child, the case is seen at the early stage, and that it is a simple spasmodic contraction of the muscle, caused by visceral derangement, the cure will most probably follow removal of the intestinal irritation. I have had many cases of children from three to five years old, who had strabismus, of from four to eighteen months standing, and who got quite well after a few emetics of ipecacuanha, followed by a couple of smart purges of rhubarb and soda. When strabismus of this character has lasted a few years, I have found much benefit from fumigating the eye with camphor, blistering before and behind the ears, dry cupping on the nape of the neck, and making the child wear goggles, the glass of which should be covered with a piece of card, having a very small hole in the centre of it, so that the child could not see except by looking through the hole. If the cause of convergent strabismus be any mark on the nose, it may be in some degree counteracted by placing something at the external side of the eye

to attract its attention ; a curl of hair may answer this purpose. When a shock or fright produces sudden strabismus, the whole nervous system will be found deranged, and must be treated accordingly.

If strabismus be of long standing, and the direct cause is a contraction of the muscle, and if none of the objections already mentioned exist, the treatment from which any benefit is to be derived consists in dividing the muscle.

Operation.—Since division of the muscle for the cure of strabismus has been first described, many surgeons have performed the operation, and for the want of success in the majority of cases, it has in some degree fallen into disrepute, and many have endeavoured to find out the cause of so many failures. M. Bonnet, a French surgeon, and Dr. Ferrall of Dublin, considered that the want of success was in consequence of the muscle not being separated from the tunica vaginalis oculi.

The following statement is made by Dr. Lucas :—“ Notwithstanding that the muscle be divided in the most satisfactory manner, and even a portion of it cut away, the eye in many cases will be found still inverted. I have ascertained beyond all doubt that this inversion is owing to the condition of the sub-muscular and sub-conjunctival fasciæ. When the inner rectus muscle is fairly divided the mark of its semicircular insertion, with minute fuzzy-tendinous fibres adhering to it, are as plainly discernible to the naked eye as the scissors with which the operation is performed ; the inversion of the eye, therefore, cannot in such cases be owing to the inner rectus muscle ; but if the sub-muscular and sub-conjunctival fascia be examined, they will be found strong and dense : and upon freely dividing them, both upwards and downwards, with a forceps and a pair of scissors, the eye in most cases will become perfectly straight,—I say in most cases, because it sometimes happens that these fasciæ are intimately adherent to the sclerotic coat, for its

inner extent, and the operator will be obliged to dissect them from it, leaving the sclerotic coat completely bare."

The Medical Gazette for July 24th, 1840, page 689, relates that Dr. Frany found it necessary in some cases to divide the tendon of the superior oblique, as well as that of the internal rectus; it has been reported, but I do not know with what truth, that Mr. Liston found it necessary to divide the inferior rectus either completely or partially, when he found the eye still retaining an obliquity inwards, after the division of the internal rectus. Now I cannot conceive what benefit could be derived in such a case, by dividing the inferior rectus; and as to cutting the superior oblique, I consider the cure much worse than the disease.

I am of opinion that there are six causes, any of which may prevent the operation from being successful.

1. The muscle being merely cut across, instead of a piece being taken out in the act of dividing it, it unites again and the disease returns.
2. When the disease, in the first instance, has been caused by paralysis of one of the muscles, which having in some degree recovered its tone is not yet sufficiently strong to keep the eye straight, after its antagonist has been divided.
3. When the eye is not turned from contraction of the muscle, but from some other cause.
4. When both eyes are affected, and one only is operated upon.
5. When the case is not strabismus, but luscitas.
- And, 6. (The most common cause). When the whole of the fibres of the muscle are not divided, and the muscle is not separated from the sclerotica.

Different men have performed this operation of myotomy in different ways, all of which appear to me to be equally good, the same object being present to all, viz:—the division of the muscle, the cutting a piece of it out, and separating it from the sclerotic coat.

The following is the manner in which I saw Dr. Wilde perform it, since when I have continued to do it in the same

way, and I have hitherto found no occasion to make any change—the number of instruments required are seven, viz:—a pair of small curved scissors, a small toothed forceps, two blunt hooks, one small sharp hook, two specula, one for the upper and the other for the lower lid; the two instruments last mentioned are not necessary if the assistant be steady and intelligent, as his fingers, in that case, are even superior to the specula. To perform the operation, two assistants are required. The patient being seated, one of the assistants stands behind him, for the purpose of raising the upper and depressing the lower lids; he should also support the patient's head against his chest, if it be not previously supported by a proper operating chair. The patient's better eye being hoodwinked; the upper lid is raised and the lower depressed by one assistant; if the muscle to be cut is the internal rectus, the patient must be directed to turn his eye outward as much as possible, when the surgeon holding the sharp hook in his hand must suddenly hook the eye-ball at the internal canthus, about the fourth of an inch from the internal edge of the cornea; the hook is intended to pierce through the conjunctiva, and tunica tendinea; with this instrument the eye-ball is to be drawn towards the external angle, and the hook given into the hands of the second assistant, with directions to keep the eye fixed in that position: now the operator, holding the forceps in his left hand, lays hold of the conjunctiva transversely, about half way between the edge of the cornea and the caruncula, and raises it in a horizontal fold, then with the scissors, which he holds in his right hand, he cuts through this fold of conjunctiva, vertically, and then enlarges the incision upwards and downwards, so that the incision will be about half an inch in length. (Here there may be a little bleeding, which will stop in a few minutes by sponging the wound.) The operator will then, with the largest of the blunt hooks dissect through the cellular tissue, till he reaches the

lower edge of the tendon of the muscle, and then slide up the hook between the muscle and the sclerotica, till it appears at the superior edge of the muscle, where if the cellular tissue prevents the point of the hook from coming through, it may be freed by a snip of the scissors. The operator having the muscle on the hook, holds the eye completely under his control, so he should at once remove the sharp hook and dispense with the second assistant. At this stage of the operation some surgeons take hold of the handle of the blunt hook, which has the muscle on it, in their hand, and direct it across the eye towards the external angle, then with one stroke of the scissors divide the muscle, by putting one blade of the scissors under the muscle, the convexity of the hook acting as a director to it; but other surgeons prefer, before dividing the muscle, to pass another blunt hook under it, whose arch being narrower collects all the fibres of the muscle together into a small space; the muscle is then put a little on the stretch, being well detached from the sclerotica, and with a pair of curved scissors, it is cut from under the hook, so as to remove that piece of it which is found lying in the convexity of the hook.

Thus the operation is performed, after which the patient's head may be released, and the bandage taken from the other eye, when if both eyes are found to have their axes perfect, all is well, but if the other eye is found converged the sooner it is operated upon the better. If immediately after the operation, however, the eye is not found to come straight at once, the operator is not to be discouraged, for it often takes a few days for the antagonist muscle, to the one cut, to recover its tone.

The reader must at once perceive, that the remarks made on convergent strabismus, are, with few exceptions, equally applicable to the divergent form; some consider cutting the external muscle the more difficult operation, in consequence of the narrow space existing between the eye-lids at the

external angle, and also on account of the insertion of the external rectus being farther removed from the cornea, than that of the internal rectus. I, however, consider these difficulties more imaginary than real.

If the patient is a child, the operator will find great advantage from having it rolled in a sheet, and laying on its back.

After-Treatment.—Generally speaking, there is very little danger of inflammation, so that after the operation is performed the person may resume his ordinary business. If inflammation should set in, it must be treated on general principles; should any fungus growth make its appearance, it should be kept down by occasionally touching it with the nitrate of silver. Some recommend after the operation, the edges of the wound in the conjunctiva being brought together with sutures; I cannot sanction this practice.

Lusctitas.—By this term is meant distortion of one or both eyes from paralysis of one of the recti muscles, the consequence of which is that the eye is turned over by the antagonist muscle, as in strabismus. In the article on strabismus, the diagnostic symptoms by which to distinguish between it and luscitas, were given, therefore they shall not be here enumerated. Luscitas generally occurs suddenly, and is nearly always accompanied with a disordered state of the system; indeed it should be looked upon more as a symptom of a disease, than as a disease in itself.

Causes.—There are many causes to produce this disease, such as chronic or acute affections of the brain, and tumours in the orbit; gastric or intestinal derangement is a very general cause, particularly in producing paralysis of the external rectus, which is the most frequent, in consequence of the union between the sixth nerve and the sympathetic.

Prognosis.—This must altogether depend upon the cause.

Treatment.—The treatment must be directed to the cause; after the removal of which if the muscle remains in a palsied

state, nothing will be found of such benefit as electricity, either in the ordinary way of insulating and drawing sparks, or the electro-magnetic currents. Blistering the temples, and brushing the raw surface with the solution of veratria, is often useful. The following case will be found interesting :—January 9, 1847—Mrs. Hooly, æt. 36, a poor woman, presented herself at the Montreal Eye and Ear Institution ; she had convergent strabismus of both eyes, and could not see the light with the right, but had sufficient sight in the left to make her way through the streets ; she told me that three weeks previously her eyes became suddenly turned, and that she partially lost her sight, which continued to get worse every day since, although from the beginning she was under the care of Dr.——. On further enquiry, I found that she had been severely blistered on the nape of the neck. Her countenance wore a haggard expression, and her tongue was furred. She had suffered, she said, from a foul stomach for many years. On examining her eyes, I found that the pupils were fixed and dilated, and the left eye not quite so much converged as the right ; conceiving that the primary cause existed in the stomach and intestines, I gave her an emetic to be taken immediately, and a purgative powder, to be taken at night, composed of calomel and rhubarb. The next morning, when she came to the Institution, her left eye was perfectly straight, and the sight of it restored ; the right was a little improved ; I gave her another emetic to be taken at once, and I ordered her to take a teacupful of the following mixture three times a day, and to return to me when it was finished :—

℞. supertart. potass ℥ss
 tart. ant. gr. i
 aquæ bullientis, lb. iss

On the third day following, this woman returned to me quite cured, her sight being perfect, and having full power over the voluntary motions of her eyes.

Oscillation of the Eye-Ball.—By this term is meant a constant rapid involuntary motion of the eye, which appears to be rotary, but which is in reality lateral, with an upward and downward action, caused by the contractions of the recti muscles following each other in rapid succession, these muscles at the time acting involuntarily, the will having no power over them. The patients are unconscious of this motion of the eye, but they sometimes complain of an apparent unsteadiness of objects. It is generally attended with short-sightedness, and sometimes a tremulous iris; during sleep the eyes are at rest.

Causes.—Congenital cataract is always accompanied with oscillation; amaurosis, either partial or complete, is sometimes a cause; scrofulous inflammation of the eye-ball sometimes produces it; fatiguing employment of the sight is another cause, and it is sometimes symptomatic of cerebral derangement.

Treatment.—If the cause be congenital cataract, the sooner the cataract is removed the better, for no matter how soon this is done it will take some time before the oscillation ceases: but if the operation be delayed, the oscillation will become incurable. When the cause is injudicious use of the sight, rest, with tonic medicines will be requisite, in fact in every case attention must be directed to the cause, but at all times it is a disease for which little can be done, no matter from what it may arise.

Case.—February 16, 1846.—Bridget Fitzgibbon, æt. 14. Blind of both eyes for 13 years, could not discover light from darkness, although the pupils contracted by the stimulus of light; she had oscillation of both eyes, but was not aware that they moved. Her parents informed me, that when she was one year old, she took a fit of screeching when in the cradle, that her eyes commenced immediately to roll, and that since that time, she had never shewn any symptoms of sight.

I treated the case as one of paralysis of the retina, for a month, when she not only could discover light, but the outlines of large bodies; however, all my efforts were unavailing to restore her sight more perfectly, and there was no improvement visible in the oscillation.

Nystagmus.—The only difference between this disease and the one last mentioned, is, that the motion of the eye is only lateral, and is caused by various nervous diseases, as hysteria, epilepsy, &c., and the only case of it I ever saw is the following:—October 15, 1846.—Mrs. H——, æt. 24, mother of three children, came to consult me concerning black motes (as she termed them) constantly dropping before her eyes for the last six months. She told me she always had bad sight, and a feeling of weariness in her eyes; on examination, I found that her eyes moved rapidly from side to side; I asked her if she was aware that her eyes were always stirring; she said that she had been told so by others, as long as she could remember, but that was the only reason she had for knowing it; objects did not appear to her to stir, and she could thread the finest needle or do the finest work, but that since the black spots appeared they gave her great annoyance. She also complained of having constant pain in her head. Conceiving that the black spots, or *muscæ volitantes*, were caused by a disordered state of the stomach, I treated her accordingly, and cured her, but I could not remove the nystagmus. This woman's hair, eye-brows, and eye-lashes, were silvery white, and the iris pinkish like that of an *Albino*.

Diplopia, (*Double Vision*).—Double vision should be considered more the symptom of a disease than as a *disease per se*. People not only sometimes see double, but treble. I had a lady patient once who saw every object she looked at multiplied six times, although she saw it with but one eye. It may be caused by a want of correspondence in the action of the muscles of the eye-ball; if this be the case,

the double vision will disappear when the person shuts one eye. It may be a symptom of cerebral, gastric, or intestinal derangement ; every one has heard the expression applied to a drunken man, that he sees double ; by using one eye more than the other, and thus rendering it weak, double vision may be produced when both eyes are open, as one eye will see the object clearly while the other sees it dimly. If one cornea be flat and the other convex (which occurs in those who are myopic in one eye and presbyopic in the other) double vision will be produced ; an irregularity in the convexity of the cornea, or an opacity of either the cornea, aqueous humour, lens, vitreous humour, or retina, may be another cause.

Treatment.—Though this disease has been considered under the head of diseases of the muscles of the eye-ball, simply because a disordered state of the muscles will produce it, yet the reader will perceive that there are many more causes for it than irregular muscular contraction, therefore the cure of the disease will depend upon the removal of the cause. When the double vision disappears on the person shutting one eye, the case is termed monoblepsis.

Tetanus Oculi.—By this term is understood a fixed state of the eye-ball, from spasm of all or several of the recti muscles. It is a symptom which sometimes occurs in trismus and tetanus. It must be considered as a symptom of some disease, rather than as being in itself a disease.

CHAPTER XV.

INJURIES AND DISEASES OF THE EYE-BROW AND EYE-LIDS.

From the exposed situation of the eye-brow and eye-lids, there are no parts of the body more liable to injury; and when we remember the complicated structure of the eye-lids, it cannot be wondered at, that they should be liable to various diseases.

Contusions.—When the eye-lids are struck by any blunt weapon, or strike against any blunt obstacle, without producing a wound of the integuments, it is called a contusion of the eye-lids. It sometimes happens, that immediately after the injury, an echymosis is formed, which is a subcutaneous effusion of blood, caused by a ruptured blood vessel, and it not unfrequently occurs that the fluid is effused into the subconjunctival cellular tissue. It often happens that the echymosis is not formed for hours after the injury. This effusion of blood gives to the skin a livid colour, besides producing a swelling; it seldom, however, excites inflammation, except in a scrofulous or unhealthy subject, but is generally absorbed in a fortnight or three weeks, the swelling subsiding, and the skin gradually attaining its natural color.

Treatment.—In the treatment there are two objects to be, if possible, attained:—First, to prevent inflammation;—Second, to hasten the absorption of the effused blood. These are best attained by the application of evaporating lotions of the acetate of lead; a few leeches may be sometimes necessary; the patient should have regular rest, and take a saline purgative. After all danger of inflammation has subsided, gentle pressure will hasten the absorption of the blood.

Poisoned Wounds.—A familiar example of a poisoned wound of the eye-brow or eye-lid, is seen in the sting of a wasp or bee, or the bite of a musquito. Such wounds sometimes produce a circumscribed inflammatory or erysipelatous swelling, the irritation being much increased by the stinging apparatus of the insect being broken off, and remaining in the part.

Treatment.—If the sting is in the part it should be extracted; if not, or even after it is removed, the part should be touched with a hair pencil previously dipped in the strong liquor of ammonia.

Burns and Scalds.—The extent of injury that the eye-lids or eye-brows receive, like all other parts of the body, depends upon the relative heat of the body, and the description of body that causes the injury, as well as the length of time the burning substance lies in contact with the parts. The sequel will also depend upon the extent of injury inflicted. The evil results to be dreaded from such injuries are ectropium or eversion of the eye-lids hæmaralopia or shortening of the lid; or anchyloblepharon or union of the edges of the lids. Burns of these parts are generally caused by the flame of a candle, the intense heat of a burning house, ignited gunpowder, boiling water, or caustic fluids such as sulphuric acid, &c.

Treatment.—The great object to be attained in the treatment is to prevent deformity, which it is sometimes impossible to avert. I think the best application is cotton wool, or the Ethereal solution of Gun Cotton. To prevent shortening, the lid should be kept constantly on the stretch, even after the part is healed; the same means must be used to prevent eversion; unless the edges of the lids are burned, there is no danger of anchyloblepharon; it can, however, be easily prevented by keeping the edges of the lids smeared with a stimulating ointment, such as the diluted citrine, or the oxide of zinc ointment.

Incised and Lacerated Wounds.—Many are the evil consequences which result from either incised or lacerated wounds of the eye-brow or eye-lids, but the lacerated wounds are the worst. The evil results to be dreaded are, symblepharon or adhesion of the lids to the eye-ball; this, however, cannot occur unless the conjunctiva covering the eye-ball be wounded. It is more likely to occur in lacerated than in incised wounds. There may be ectropium, ptosis; or the edges of the wound may not unite, but leave a perpendicular slit in the lid, which is termed coloboma palpebræ;* or amaurosis may be produced by wounding the frontal nerve. Phlegmanous or erysipelatous inflammation may set in, and spread into the orbital cellular tissue, finally producing destruction of the eye-ball; this latter accident, however, is not so likely to occur in incised as in lacerated wounds. Eversion, or shortening of the lids, cannot occur if there be union by the first intention, nor can ptosis take place without complete division of the levator palpebræ muscle, or injury of the nerve which supplies it. Nothing but improper treatment will prevent incised wounds from uniting by the first intention; it is not so with lacerated wounds.

Treatment.—Every effort should be made to get the wound healed by the first intention; this is generally easily enough accomplished in incised wounds, by bringing the edges together with strips of adhesive plaster, and covering them with a compress and bandage; but if the wound be perpendicular, separating the lid at its edge, the fibres of the orbicularis will contract, and cause the wound to gape; it will therefore be necessary in that case, to use the twisted suture, the operator being careful to pass the needles through the lid. The same rules which apply to incised, are

* Mr. Wilde of Dublin saw a case of coloboma palpebræ which was a congenital malformation.—Dublin Quarterly Journal of Medical Science, May, 1848, page 469.

applicable to lacerated wounds, but in a lacerated wound it is usually necessary to clean it out well, lest any foreign body should be lurking in it. Sutures and stitches may be used in all such cases, but should be avoided if the wound can be brought and kept together with adhesive plaster and a compress and roller. Symblepharon can be prevented, by passing a probe, smeared with ointment, two or three times a day, between the eye-lid and the eye-ball.

Case.—August 10th, 1846.—John S., æt. 35, by trade a cooper, was corking a bottle of beer, when the bottle burst, and two pieces of the glass struck him: one piece wounded the upper lid of the left eye, the second piece the lower lid of the right. On examination, I found a perpendicular wound of about half an inch long through the upper lid of the left eye; it extended into the sclerotic coat, through which protruded the greater part of the iris, and a part of the choroid coat; the edge of the lid was not separated. The lower lid of the right eye was similarly wounded, but the eye-ball was not injured. Four days after the accident, the man was at his work, as well as ever.

Treatment.—Having ascertained that there were no bits of glass in the wound, I first made pressure on the prolapsed iris, then suddenly exposed the pupil to a strong light, when it contracted, and the iris and choroid coat were restored to their natural position. I then drew together the edges of the wound in the lid, with strips of adhesive plaster, and covered the whole with a compress and bandage; I dressed the right lid in the same way, and then ordered him to bed, with directions to lie as much as possible upon his back. I gave him a good purge of calomel and jalap, which was followed up by nauseating doses of tartarised antimony. There was no more inflammation than was necessary for producing adhesion.

Phlegmonous Inflammation of the Eye-lids.—This description of inflammation more frequently attacks the upper than the lower eye-lid. The evils likely to arise from neglect, or improper treatment, are shortening of the lid and ectropium.

Symptoms.—The lid becomes tense, hot, red, swollen, and painful to the touch, the swelling increases and closes the lids, every attempt to open them increasing the pain. As the inflammation advances, the pain becomes pulsative, the swollen parts assume a livid red colour, and finally point about the middle or more generally at the external angle, of the lid. At this stage fluctuation can be felt, and as the hardness disappears, the parts become less sensitive to the touch. If the matter be not now evacuated it bursts—spontaneously, either on the inside or outside of the lid, but more generally the latter; the abscess finally heals by granulation, and when the granulations become absorbed, the lid is left contracted or shortened.

Causes.—The causes which produce phlegmonous inflammation of the eye-lids, are very obscure, but the most frequent one, is direct violence applied to them, as in pugilistic combats, &c.

Prognosis.—If the surgeon sees the case before the abscess bursts, or the integuments covering it are destroyed, he may give a favourable prognosis; but if any part of the integuments be lost, it is nearly impossible to prevent contraction of the lid.

Treatment.—During the inflammatory stage, every effort should be made to prevent its terminating in suppuration; the local treatment therefore should be leeching and the constant application of evaporating lotions,—the constitutional treatment purging, nauseants, diaphoretics, quietness and low living. The moment the suppurative stage has commenced, warm poultices should be applied, and when fluctuation is perceived, the matter should be at once eva-

coated with a lancet. The opening ought to be made parallel to the folds of the skin, after which, the poultice should be continued until the swelling subsides, and the discharge ceases; then a little simple dressing finishes the cure. I have treated numerous cases of this description, not one of which ever terminated badly, which I attribute to having always evacuated the matter, the moment I discovered fluctuation.

Erysipelatous Inflammation of the Eye-lids.—It is very seldom that the eye-lids alone are the seat of this disease, but when such inflammation attacks the face, it generally spreads into the eye-lids.

Symptoms.—The local symptoms of this form of inflammation, when situated in the eye-lids, are the same as would be presented in any other part of the body. The lids become so swollen, that they cannot be separated, their color varies from a pale to a deep livid red hue; this color momentarily disappears, if pressure with the finger be made on the part, but it returns immediately after the pressure is removed; the pain is of a burning, stinging kind; very frequently serous effusion takes place under the cuticle, forming vesicles that burst and discharge the serum, which hardens into a crust over the part; this crust eventually falls off and leaves the skin in a sound state; and the swelling at the same time subsiding, the disease is removed. This is the most favourable termination the disease can take, but unfortunately it too often takes a worse form, namely, suppuration, with sloughing of the cellular membrane; the same local symptoms will then be present, as have been described in the last article, headed "Phlegmonous Inflammation," the only difference being, that in this disease, the color of the integuments is of a more livid hue, and fluctuation is not so distinct. The matter is not, as in phlegmon, bound by a sphere of adhesive inflammation, but spreads in different directions, producing

sloughs of the cellular membrane. Instead of pointing in one spot, and bursting as a phlegmon does, there are one or more points of the integuments, which give way, through which disorganised cellular membrane will be discharged, or may be extracted; this is the sort of case which generally leaves the lids so altered, that it is long, if ever, before they recover their natural state. In these cases, the excreting lachrymal organs, meibomian follicles, and conjunctiva, always suffer more or less; the internal canthus of the eye is generally found every morning filled with puro-mucous secretion. Impediments to the absorption of tears, and slight accumulation of mucus in the lachrymal sac, constantly take place; and in very severe cases, the diffused suppuration will sometimes penetrate even the lachrymal sac, producing such destruction in it and the lachrymal canals, as ever after to render them unfit to carry on their functions. Cases have been known, where death was the result of erysipelatous inflammation spreading from the eye-lids to the cellular membrane of the orbit.

Constitutional Symptoms.—The constitutional symptoms are rigors, followed by febrile irritation, the tongue is loaded, and the digestive organs deranged. When the case terminates fatally, death is generally preceded by delirium.

Causes.—The local causes are blows, wounds, stings of insects, sudden alternation of heat and cold, &c. When there is no local injury, the cause is generally obscure; it may be owing to some peculiar state of the atmosphere, or to contagion.

Treatment.—The general treatment consists in, first—emptying the stomach and bowels, with an emeto-cathartic; after which gentle diaphoretics and nauseating doses of tartarised antimony are to be employed; some recommend blood-letting, but it should never be practised, unless the patient is strong and robust; and such are rarely the subjects of this disease. Rest, quietness and a low unstimulating diet should be rigidly observed.

Local Treatment.—Numerous local applications have been recommended in this disease; from my own experience, I cannot say much in favour of any of them; I give the preference, however, to the mild soothing applications. French wadding is the substance I generally use for this purpose; it encourages moisture on the part, which always gives relief, and if bullæ form it acts as it does in scalds. Some recommend cold evaporating lotions, some painting the part with tincture of iodine, some laud the powers of nitrate of silver; others puncture the parts with a lancet, and others again recommend making deep scarifications.

A deep incision through the integuments and subcutaneous cellular tissue, may sometimes prevent suppuration from setting in; at all events such an incision is most beneficial where matter is actually formed, after which warm poultices should be applied; should the symptoms indicate that matter is formed in the orbit, it should be evacuated without delay; should chronic dacryocystitis continue, it must be treated according to the instructions contained in Chapter XIII. The inordinate secretion of mucus may be prevented during the treatment, by dropping once or twice a day upon the conjunctiva, the four or five grain solution of the nitrate of silver. When persons have died of this disease, *post mortem* examinations have shown, in some cases, the veins in connection with the scalp, eye, eye-lids, &c., to be full of pus.

Carbuncle or Anthrax of the Eye-lids.—The eye-lid sometimes becomes the seat of anthrax. The symptoms are heat, violent pain, and a pimple is formed which is attended with great itching; below this pimple a hard circumscribed tumour can be felt, which soon assumes a dark red or purple color at its centre, but which is pale towards its edge; there next appears a blister upon its apex, which breaks and discharges a thin brown serous fluid.

Causes.—This disease most frequently occurs in old debilitated persons, whose health has been broken by voluptuous living. If the patient be not an old person he is sure to possess a bad, weak, and irritable constitution. Exanthematous fevers, such as measles, small pox, &c., act as exciting causes.

Treatment.—The local treatment consists in making an early and free incision into the tumour, so that the matter and sloughs may readily escape, as much as possible of which should be at once pressed out; the part is then to be covered with a warm emollient poultice, which should be renewed every six or seven hours, until all the sloughs are cast off, and the surface of the cavity appears red and granulating, when it may be dressed with any mild unirritating ointment, spread upon lint, over which a compress and bandage may be applied.

The constitutional treatment should be of a tonic kind, such as quinine and the aromatic sulphuric acid; a little wine will be found necessary, and when the pain is very great, opium will be useful, both as a sedative and stimulant.

Syphilitic Ulceration of the Eye-lids.—The eye-lid may be the seat of either primary or secondary syphilitic ulceration. When this disease first attacks the edges of the lids, it is hardly distinguishable from ophthalmia tarsi or tinea palpebrarum; but its true character soon declares itself, the destructive process being generally very rapid, destroying skin, cartilage, and conjunctiva altogether. The part of the lid that I have most frequently found affected is the conjunctiva; I do not remember ever having witnessed a case of primary syphilitic ulceration of the eye-lids, but I have seen a few of the secondary.

Diagnosis.—The history of the case will generally give a clue to the surgeon. Its true nature may be surmised if the ordinary treatment for ophthalmia tarsi fails in arrest-

ing the progress of the disease. Generally speaking, syphilitic eruptions or ulcerations are present on other parts of the body; indeed this affection of the eye is almost always accompanied with either chancre, sore throat, or some other unmistakable syphilitic symptoms.

Causes.—When the ulcers are primary they owe their origin to direct contagion. The virus is usually communicated by the patient himself, who, perhaps, rubs his eyes after having recently handled a chancre. A child may get it during parturition if the mother is affected; it is then generally found to make its appearance two or three weeks after birth, when the infant's organs of generation and its arms will generally be the parts tainted.

Treatment.—If the ulcers be primary they may be got to heal by the application of the nitrate of silver, either in substance or in solution, followed by solutions of either the sulphate of copper or zinc; whether the case be primary or secondary, this is the best local treatment. The constitutional treatment consists in the administration of either calomel and opium, the ioduretted iodide of potassium, or turpentine; most cases yield to mercury, but I have succeeded in a few with turpentine, where the ulcers were on the inner part of the upper eye-lid, and about the size of a threepenny bit; in two of the cases there were vascular nebula. If the patient be an infant, great caution should be used in administering the calomel and opium; one grain of the former with the one-twelfth of a grain of the latter may be given twice a day; and the best local treatment will be tepid ablutions, and brushing the edges of the lids with a weak solution of the nitrate of silver, or smearing them at night with a mild precipitate salve.

Scirrhus, and Cancer of the Eye-lids.—This disease in the eye-lids, as in other parts, presents two stages:—viz: induration, and ulceration. It may attack any part of the

lids, but the most frequent part is the internal or external angle of the lower lid. The part at first becomes thickened and elevated, without any inflammation or discoloration of the skin ; the lid also becomes as it were contracted, having to the patient a feeling of tightness, and a great want of mobility. This is the first stage, which may continue for a considerable length of time before the ulcerative or cancerous stage sets in ; it is generally slow in its progress, but it is also sometimes very rapid, destroying the eye-lids, eyeball, orbit, lachrymal passages, nose, and the whole of the cheek ; its progress will in some instances suddenly stop at this stage, and the patient linger on in this condition for years. The ulcerative process presents different appearances at various times, successive scabs will sometimes form, the ulcer becoming deeper and more painful each time : when it ceases to scab it eats away all the parts indiscriminately, but generally speaking in one direction only, its progress appearing to be checked in the others ; sometimes the whole ulcer puts on a healing appearance, throwing out healthy granulations, which last for a considerable time, the pain becoming greatly abated ; but at the very time that it appears most healthy, ulceration again sets in, and probably goes on more rapidly than ever. Blood is not effused from the surface of the sore, but occasionally one of the veins gives way, and there is considerable hemorrhage. The discharge differs very much at different periods, changing from a healthy to an unhealthy appearance ; some people suffer much greater pain than others, but in some cases it is not so great as the ravages of the disease would lead an observer to suppose.

Dr. Jacob says, and I think with much truth, "That the principal distress seems to arise from the exposure, by ulceration, of nerves and other highly sensitive parts."

When the constitution begins to break up, there is much fever, and sometimes diarrhœa, either of which generally kills the patient.

It is very doubtful in which texture of the eye-lid the disease commences, whether the conjunctiva, meibomian glands, cartilage, integuments, &c., but the general opinion is, that it begins in the conjunctiva and that the neighboring textures gradually become involved; I have, however, seen it commence in the integuments on the external angle of the eye.

Diagnosis.—The diseases with which this may be confused, are true carcinoma, lupus, or syphilitic chancre. Dr. Jacob says, it may be distinguished from true carcinoma by the absence of lancinating pain, fungus growth, fœtor, slough, hemorrhage, and contamination of the lymphatics, —and from lupus, by the absence of furfuracious scabs, and inflamed margins, as well as by the general appearance of the ulcer, its slow progress, and the absence of swelling in the integuments around the ulcer, as well as by its history.

Treatment.—The only treatment from which any benefit can be derived, is extirpation of the whole of the diseased part with the knife; it is quicker, less painful, and more certain than the use of caustic, or the actual canter. I see that there is a case recorded in the *Boston Medical Journal*, of a Medical man curing himself of this disease by living upon bread and milk for two years. This is certainly an easy cure for cancer.

Inflammation of the Edges of the Eye-lids.—The general term by which this disease is known is ophthalmia tarsi, or as Dr. Jacob calls it, tinea palpebrarum. It has also been termed psorophthalmia, scabies palpebrarum, lippus, and blear eyes.

The local symptoms of this disease, are a glutinous secretion becoming incrustrated on the eye-lashes during the night, and binding the eye-lids so close together, that it is with very great difficulty the patient can get them separated when he awakes in the morning; even after frequent ablu-

tions of warm water the eye-lashes will be pulled out from the root, producing great irritation. This discharge is secreted by the conjunctiva, meibomian glands, and follicles. The itching of the eye-lids is sometimes intolerable, and the consequent irritation excites a greater flow of tears than is natural, which, with the discharge, is carried over the cheek, chapping and excoriating the integuments and producing ulceration and scabs; when this state of things continues long, the whole substance of the edges of the lids becomes thickened, indurated, and distorted,—to this the term *tylosis* is given.

The seat of the disease seems to vary in different cases; in some the morbid changes take place in the ciliary glands or bulbs of the eye-lashes, in others the meibomian follicles, but, generally speaking, the inflammation begins in the roots of the hairs, and terminates in little abscesses and ulcers, the bulbs of the eye-lashes becoming destroyed, so that the few feeble lashes that remain are weak and irregular. Intolerance of light and partial amaurosis often accompany this disease: the inflammation frequently spreads to the conjunctiva covering the eye-ball, and if it be neglected or badly treated, it may result in total obliteration of the meibomian apertures by their orifices becoming skinned over, and the inner margin of the lids being rounded off, instead of defined, which state is incurable, so that the person will have blear eyes all his lifetime. Eversion of the lower lid may be caused by the excoriation of the cheek and eye-lids healing up, leaving the skin contracted by a cicatrix. Trichiasis is not a very unusual consequence of neglected or badly treated *tinea palpebrarum*.

Causes.—This disease is very generally found in patients of a scrofulous diathesis: measles, scarlatina, small pox, cold, impure air, smoke, filthiness, &c., all act as exciting causes, not forgetting the habitual use of ardent spirits, which keeps up the disease in adults; the knowledge of this fact has procured for it the name of “the whiskey eye.”

Treatment.—The treatment will vary according to its stage, and indeed must be regulated according to the nature of each case, inasmuch as that which would cure one patient would often be injurious to another. During the inflammatory stage, scarifying the palpebral conjunctiva, and applying leeches behind the ears, will be found useful. Emollient, refrigerent, astringent, or evaporating lotions are all useful, and the surgeon may employ them according as he finds them give relief to the patient. But whatever the applications may be, the parts must be kept well cleaned, by frequent ablutions of warm water during the day, for on no account should the crust be allowed to collect on the edges of the lids; all applications would be useless unless applied to the diseased part itself, and not to the crust that covers it. Generally speaking, cleanliness is the most important, and at the same time most neglected, part of the treatment. To prevent the edges of the lids from becoming encrusted and adhering together during the night, the patient should, before going to sleep, smear the edges of the lids with a little fresh butter, and he should not attempt to open them in the morning, until he has first washed them with a sponge and warm water. When the second stage has commenced, cleanliness is just as necessary, and every morning for a few days the ulcers may be touched with either the pure nitrate of silver or the ten grain solution; after which it may be changed to the ointment composed of equal parts of Janin's ophthalmic ointment, and the citrine ointment. During the evening the patient may bathe his eyes with a weak solution of the sulphate of alum, sulphate of zinc, or the oxymuriate of mercury; but I would give the preference to the alum wash.*

If the edges of the lids become indurated, all the hairs

* NOTE. I have found much benefit from a lotion composed of an infusion of green tea and a little alum in it, not only in this disease but in other inflammations of the eye requiring astringent applications.

should be extracted, and the parts touched once or twice a day with either a stimulating ointment, or lotion, which ever is found to agree best with the case. Mr. Mackenzie speaks highly of the value of counter-irritation to the nape of the neck, behind the ears, in the arm, &c. I must say, I have never been fortunate enough to find any benefit to arise from such treatment, but, on the contrary, in the majority of cases it has proved worse than useless.

Constitutional Treatment.—In the first stage an emetic followed by a purgative, will be found useful, after which tonics and alteratives should be resorted to. Pure air, regular exercise, warm clothing, and wholesome food, are particularly indicated; and, as necessary precautions, cold, damp, sitting up till late hours, and artificial light, should be shunned. I constantly find that this disease disappears at the age of puberty, particularly in females, unless it has run into the second stage. In all cases while there is the slightest prospect of a cure, the treatment should be persevered in, even for years.

Porriigo Larvalis of the Eye-lids.—It never seizes the eye-lids, without previously attacking the head or face, from which it spreads,—such cases are rare. As a general rule the head and face are affected while the nose and eye-lids escape. Infants are usually the subjects of it; this is true tinea.

Symptoms.—The symptoms are the same as in any other part of the face, except that, in addition, there is often accompanying it a puro-mucous conjunctivitis.

It begins with an eruption of numerous minute whitish pustules, which break and discharge a viscid fluid that concretes into thin yellowish or greenish scabs, which become thicker as the disease advances, and glueing the eye-lids together, produce great irritation; the patient's greatest suffering is from the itching of the diseased parts. It is not unusual to find, in such cases, the lymphatic glands

affected, and if the patient is a child it sometimes dies of hectic or irritative fever, and diarrhœa.

Treatment.—The local treatment consists in keeping the parts well cleaned, and the edges of the lids smeared with a stimulating ointment, such as Janin's ophthalmic, and the unguentum citrini. If the conjunctiva is affected the four grain solution of the nitrate of silver must be dropped on it, once or twice every day. The constitutional treatment consists of alteratives and tonics. I have never discovered anything superior to quinine, and very minute doses of the tartarised antimony: an occasional purgative of rhubarb and soda is also very necessary.

Disease of the Meibomian Glands.—The meibomian glands sometimes inflame and form abscesses on the inner side of the lower lid. They should be opened with the point of a lancet, the matter squeezed out, and a stimulating ointment applied, to the little sacs, with the point of a probe. When a film growing over the mouth of the meibomian ducts, as a consequence of ophthalmia tarsi, obstructs them, the secretion in the ducts accumulates and presents the appearance of a small abscess: the treatment of which must be the same as if it were a real abscess, viz: to open them with the point of a lancet. When the ducts are plugged up with calcereous deposits, they also should be removed with the point of a lancet or cataract needle.

Hordeolum.—The hordeolum, or sty, is a small boil on the edge of the eye-lid: it is of a dark red color very painful and hard. It rarely ever terminates in resolution, and its process of suppuration is very slow and imperfect, having very little tendency to burst: when this happens spontaneously, it generally leaves a hard tumour in the part, which deforms the edge of the eye-lid, in some degree: and is very likely to bring on a renewal of the sty.

In delicate and irritable persons, it is frequently accompanied with fever and restlessness.

Causes.—The subjects are generally of a scrofulous diathesis or otherwise unhealthy ; late hours, worshipping at the shrine of Bacchus, or living on acrid irritating foods, act as exciting causes.

Treatment.—When the inflammation is in the first stage, resolution may be attained by the application of cold lotions, such as ice, vinegar and water, &c., but when the second stage has commenced, suppuration should be encouraged by applying warm emollient poultices : and the moment the abscess points, it should be laid open with a lancet, and the pus and dead cellular membrane squeezed out. The cavity generally heals up in about twenty-four hours ; but if it should not, it ought to be touched with the nitrate of silver, which will remove any dead cellular tissue that may be remaining. Any person subject to styes, should avoid all the exciting causes that would be likely to produce them.

Phlyctenula.—There are sometimes found on the edge of the eye-lids, either singly or in groups, small transparent vesicles, which are filled with a watery fluid,—these vesicles are called phlyctenula.

The cure consists in cutting them off with a pair of scissors, and then touching the part with the nitrate of silver.

Millium.—These are small tumours, containing a suet-like substance, which are generated at the roots of the cilia ; they are to be opened with a lancet, and their contents squeezed out.

Warts on the Edges of the Lids.—Warts growing on the edge of the lids sometimes give great annoyance. They may be cut off with the scissors, strangulated with a ligature, or destroyed with the nitrate of silver ; I prefer the use of the scissors.

Tumours in the Eye-brow and Eye-lids.—The eye-brow and eye-lids, particularly the latter, are very frequently the

seat of encysted tumours ; according to Beer, the external angle of the upper eye-lid is generally the seat of the atheroma and meliceris. The steatomata are sometimes situated in the vicinity of one of the eye-lids, and at other times over the lachrymal sac. These tumours may be seated either in the sub-cutaneous cellular tissue, under the orbicularis muscle, or on the cartilage. Generally speaking, they are very movable, but when on the cartilage they are most frequently attached to it. The only harm ordinarily occasioned by these tumours, unless when they become inflamed, and suppurate, is to prevent the eye-lid from being opened by coming in contact with the edge of the orbit. The steatomata never grow to so large a size as the atheroma and meliceris.

Treatment.—The general remedy for these tumours is extirpation ; when it can be accomplished they should be removed from the inside of the lid, but if they are superficial they should be removed from the outside ; on no account whatever should the cartilage be cut through to reach the tumour. For a few days previously to their removal, the patient should constantly move the tumour about under the integuments with his fingers, so as to loosen it from its attachments. To remove it externally there should be made through the parts covering it, a horizontal incision the full length of the tumour ; then a sharp pointed bistoury should be passed between the tumour and its covering, so as to completely detach them from one another ; the tumour can then be squeezed out, and the attachments to its base easily separated with a pair of scissors ; if, however, it should adhere to the cartilage, it may then be shaved off with a knife ; the wound in general is made to heal very easily, by covering it with a small piece of adhesive plaster ; or by bringing its edges together with one or two stitches, according to the size of the wound. If the tumour be very large, the redundant integument should be removed by two elliptical

incisions. During the operation, the surgeon ought, if possible, to avoid bursting the cyst, for it would render the operation more tedious; should this happen, however, he must take hold of the sac with the forceps, and dissect it out; if the tumour be seated near the palpebral conjunctiva, it is easily extirpated, by everting the lid, and cutting through the conjunctiva. Mr. Mackenzie says, that instead of attempting a regular extirpation, it may sometimes be advisable merely to lay the cyst open with a lancet, squeeze out its contents, and then introduce into its cavity for a few seconds a pencil of lunar caustic or pure potash, after which, in a few days the sac will come away and the wound heal. Velpeau recommends the same treatment, but adds that extirpation is the most prompt method. It is a treatment I can speak of from experience, and never hesitate to adopt it, always opening the tumor on the inside of the lid.

Other tumours not encysted may form on the eye-lids, which it would be useless to think of regularly extirpating: they sometimes burst and get well, but if they do not, they may be opened with a lancet, and their contents, which will be found to be either gelatinous, or albuminous, squeezed out.

Adults of an unhealthy constitution are generally the subjects of the former or gelatinous tumor; and scrofulous children of the latter. When in the incipient stage, these tumours may disappear, under the use of tonics.

Tylosis, or Callosity of the Eye-lids.—Mr. Mackenzie divides tylosis into three varieties, viz: scrofulous, arthritic, and scirrroid. He says the second description rarely occurs except in those whose digestive organs are deranged by the habitual use of ardent spirits,—that its seat is external to the cartilage, and generally situated in the upper eye-lid,—that he never saw it end in suppuration or ulceration,—and that it slowly increases and then becomes stationary. As a local treatment he recommends leeches, and frictions

with camphorated mercurial ointment. He recommends laxatives and alteratives in the general treatment. Even this practice he acknowledges to be generally unsuccessful. His third variety, which he calls tylosis scirrroides, he says, is of a white or slightly yellow color, more or less tuberculated, and apt to run into ulceration ; from which fact, with its appearance, intractable nature, and occurrence in old persons, it is liable to be confused with scirrhus. He concludes by saying that although the progress of the disease may be arrested in some cases by Fowler's solution of arsenic, taken internally, the application of lunar caustic and red precipitate ointment to the edges of the lids,—still in other cases the tumour has caused such irritation of the eye, increased so much in size, and produced such deformity, as to warrant the extirpation of the indurated portion.

Now I must say this, to me, looks very like scirrhus ; certainly there is no line of demarcation : and it appears of but very little consequence, as the treatment is the same in both cases.—(See *Inflammation of the edges of the eye-lids.*)

Nævus Maternus, and Aneurism by Anastomosis of the Eye-brow, and Eye-lids.—There is a vast difference between aneurism by anastomosis, and nævus. The latter is simply an organic malformation of the skin, while the former often proves a very serious disease. The French give to it the name of erectile tumour. I do not mean to enter into the description of a disease, that has been already fully explained by every author on surgery ; it will be sufficient for me to say, that when it occurs in the eye-brows and eye-lids, it is exactly the same as when it occurs in any other part of the body, sometimes remaining stationary, causing no inconvenience, and consequently requiring no treatment ; and at other times, from its increasing size and the danger of its causing death by hemorrhage, requiring active treatment.

Treatment.—Various methods have been recommended for the cure of nævus, and aneurism by anastomosis, all of which seem to have occasionally succeeded, and as often to have failed.

There is one of two objects to be attained in the treatment of aneurism by anastomosis,—the first is to produce obliteration of the part, either by producing inflammation in it or cutting off the flow of blood into it; the other is the removal or destruction of the affected part. The choice of treatment will depend upon circumstances, such as the size, situation of the tumor, &c; some have succeeded in curing nævus by constant and well directed pressure, combined with evaporating lotions of the acetate of lead; this treatment was recommended by Dr. Sigmund, and I can bear testimony to its good effects, so far as the acetate of lead is concerned, but pressure I have always found to aggravate the disease.

Puncturing the tumor with needles, and then keeping up pressure, is another treatment highly spoken of; I cannot testify to it from experience.

Professor Pattison of New York, says that the safest plan of treatment is the one he practises, which is the actual cautery. The mode in which he operates is by passing repeatedly through the tumor red hot needles, the operation to be renewed at intervals of a week. He says the result is, that in the course of a month it entirely sloughs away, and the part heals, without a vestige of diseased structure being left. The nævus he thus managed was situated upon the shoulder, but of course such treatment would never do for a nævus of the eye-lid or eye-brow, as it would cause such a loss of substance, as to produce ectropium and shortening of the eye-lid.

M. Pigeaux and M. Carron du Villars speak highly of vaccinating the part, particularly if the person has not already been vaccinated. The former says, that to ensure

success the points of insertion should be sufficiently numerous to produce a confluent pock, and should any portion of the erectile tissue remain after the scabs fall off, it must be destroyed with some such caustic as powdered alum.

M. Carron du Villars inoculated the tumor and its circumference with vaccine virus, by traversing it with a thread impregnated with the virus. He found that five pustules appeared, on the fifth day, round the tumor, and that the whole tumor was inflamed; the tenth day it was covered with a black crust, which came off on the twentieth, leaving a healthy rosy surface beneath it, all traces of the erectile tumor having disappeared. The patient was a girl of fourteen; the tumor was on the upper eye-lid.

M. Carron du Villars also used the actual cautery, but in a different way from Professor Pattison. In his case he fixed in the tumor three entomological pins, and bound their three extremities together with silver wire, which was then exposed to the flame of a wax-candle; the tumor immediately swelled, cracked, and then sunk; on withdrawing the pins they brought away a portion of the parenchyma. In eight days after, the child was well.

Some recommend that the tumor should be inoculated with some stimulating substance, particularly if the person has been previously vaccinated. N. Sofarque speaks highly of croton oil; he recommends that five or six punctures should be made on and around the tumor, with a lancet, that has been previously dipped in the oil. He states that the punctures immediately cause a pimple, which in thirty-six hours is developed into a little boil, all which unite and form a hot, red, and painful tumor, covered with a white crust, resembling a small carbuncle: two days afterwards the scabs separate, and in the place of the nœvus is seen an ulcer, which is to be treated on general principles. He concludes by saying that it would be dangerous to make more than six punctures on a very young infant, as the irri-

tation and fever are considerable. Some recommend that tartarised antimony should be used, instead of the croton oil, in a similar way. M. Carron du Villars gives another case of such a tumor on the upper eye-lid of a young woman, which he cured by the coagulating method; he accomplished this by injecting a styptic solution into the tumor by means of Anel's syringe; the result was that the tumor became of a black color, which soon after faded away; on the fourth day it was surrounded by an inflammatory circle, and covered by small phlyctuna; and the fifth, a portion of it separated, and the rest dried up; on the eighth day the entire crust fell off, leaving underneath a rosy new skin, similar to that of a cicatrised blister, without deformity or loss of substance. Previous to performing this operation of injecting the tumor, it should be compressed so as to empty it of its blood. The aperture in the skin for the point of the syringe should be made at the edge of, and not in the tumour itself; when the fluid is injected, it should be retained in the tumor for five or ten minutes, after which it may be again discharged. Mr. Lloyd, who has used an escharotic fluid in this way, recommends pressure to be made round the base of the tumor during the process of injection, lest the fluid should be forced into the contiguous cellular tissue, where it might excite inflammation. Mr. Mackenzie thinks there is a greater danger attending this mode of treatment, viz: the passage of some of the fluid into the veins, and thence to the heart; such an accident may be possible, but I certainly should say very improbable. However, the caution should by all means be observed, therefore pressure should be made round the tumour with a small hoop, or what Mr. Lloyd recommends, the cover of a small pill box with a notch in its edge for the passage of the point of the syringe. For my part I never should think of using an escharotic lotion, a styptic being all that is necessary to produce coagulation.

The most powerful escharotics have been applied to the surface of these tumors, for the purpose of destroying them by sloughing: no matter how successful the treatment may be, there must always be a great loss of substance, and this objection will apply with greater force if the tumor happen to be situated on the eye-lid.

Dr. Marshal Hall recommends incision of the vessels within the tumor. He effected a cure by this method, although before it took place a half year had elapsed after the operation. His theory was, that he expected it would produce inflammation, and a cicatrix be formed, whose solid texture and progressive contraction would in time obliterate the tumor. The manner in which he performed the operation was by introducing a couching needle, with cutting edges, at one part of the circumference of the *nævus*, close by the healthy skin, and from this point he passed the instrument through the tumor in eight or ten different directions, the first puncture being the only one that was made through the skin. After he had withdrawn the needle, a little pressure was made on the tumour with strips of adhesive plaster. He mentions that there was neither pain nor hemorrhage; and attributes no particular benefit to the employment of the pressure, but says the operation may be repeated at shorter or longer intervals, as occasion may require, or according to the degree of inflammatory action necessary for the obliteration of the *nævus*.

Mr. Fawdington, of Manchester, recommends the use of a seton. It is painful and uncertain, and in arterial cases dangerous, nevertheless it has this advantage attending it, that when successful it leaves very little deformity. If sufficient inflammation be not produced, any escharotic can be applied to the internal part of the tumor by means of the seton, without destroying the integuments.

Some think the ligature the most useful means for removing these tumors; there are two methods of applying

it, viz :—First, by transfixing the tumor with two needles, passed through its base, the needles crossing each other ; the ligature is then placed under the needles, round the base of the tumor, and drawn tight, so as to strangulate the tumor, after which the needles are withdrawn. The second method consists in passing a curved needle, armed with two ligatures, through the base of the tumor, so as to divide it into two parts, each portion of which is to be constricted by its own ligature.

When a ligature is employed, the tumor generally shrinks, turns black, and falls off in the course of five or six days ; after which the exposed surface should be poulticed, until it granulates, when it may be treated as a simple ulcer.

For many years the radical cure of *nævus* and aneurism by anastomosis, was excision, which, under every circumstance, is a dangerous operation ; for no matter how far the knife be kept from the tumor, the blood-vessels in its vicinity are always so enlarged, that there is much danger from hemorrhage : however, should the surgeon decide on this mode of treatment, he must be prepared to remove all the diseased part ; and if it be the eye-lid he may replace the loss of substance by the *blepharoplastic* operation, taking the new portion from the temple of the patient.

To obliterate an aneurism by anastomosis in the orbit, Mr. Travers tied the common carotid artery ; Mr. Wardrop followed his example, but in his case the *nævus* was external. The operation is certainly a bold one, and one I would be far from undertaking, except to save life.

Having described all the different modes that have been recommended for the cure of this disease, I have only to add, that circumstances, such as the size and situation of the tumor, must guide the surgeon as to which mode he will adopt ; if circumstances would permit, perhaps there is no better treatment (if evaporating lotions of the acetate of

lead fail) than the actual cautery, as recommended by M. Carron du Villars, or injecting the tumor with styptics, or astringents, as in neither case is there any loss of substance.

Œdema of the Eye-lids.—This disease may be either general or local, but it is more generally the latter. The local causes are acute ophthalmia, wounds, bruises, or erysipelas of the eye-lids, disease of the orbit, pressure or abscess in the neighborhood of the lids, emollient fomentations and poultices long continued to the lids; any of these may act as exciting causes. The constitutional causes are general anasarca, consequent upon any eruptive fever, scrofula, &c.

Symptoms.—The lids are swollen, smooth, pale, semi-transparent, and soft, and their motion is impaired; they will retain for a time the depression caused by pressure of the finger.

Treatment.—If there be any local exciting cause, it must be removed; if there is anasarca, a general treatment must be adopted, such as diuretics, diaphoretics and purgatives, followed up by tonics, &c. When there is no evident cause, gentle stimulating applications to the lids will excite the action of the absorbents; blisters before the ears, or on the nape of the neck, will also be found useful.

Emphysema of the Eye-lids.—Air in the cellular tissue of the eye-lids is the cause of this disease; it may be either general or local;—general, when the air escapes from the lungs, and spreads through the cellular tissue of the whole body, —local, when the air escapes from the nose, in consequence of an opening in the nasal parietes, into the cellular membrane of the eye-lids.

Treatment.—Evacuating the air, by means of an opening in the integuments, is recommended as a palliative treat-

ment ; but, of course, a radical cure must depend on the removal of the cause, whatever that may be.*

Twitching of the Eye-lids.—Some persons suffer great annoyance from a constant involuntary twitching of the eye-lids, which is generally confined to the lids of one eye. The eye-lid, goes at a most rapid rate, and though the patient is perfectly conscious of it, he still cannot by any effort stop it; indeed every effort seems only to aggravate it. Some cases are worse than others, as in some the twitching is confined to the eye-lids, while in others all the muscles on that side of the face are affected, drawing the mouth to one side. Grief, joy, or any thing which will agitate the mind, aggravates the disease. Some authors have seen it accompanied with pain,—I never have; but all the patients I have ever seen afflicted with it, complained of great weariness of the affected part, and more or less weakness of vision.

Causes.—The direct cause is derangement of the portio dura of the seventh nerve ;—the remote cause is generally some deranged state of the digestive organs. Persons of intemperate habits are generally the subjects of it. Old cooks, who have been accustomed to take ardent spirits, are the persons I have generally found afflicted with this disease.

Treatment.—Laxatives, alteratives and tonics, have been found the best general treatment : I have found croton oil the best laxative, and quinine the best tonic. Bleeding and mercury seem only to aggravate the disease, particularly the latter, unless given as an alterative. It is very impor-

* Case of Emphysema of the eye-lids, caused by blowing the nose.

May 12th, 1849. R. D., Esq., aged 30, presented himself at my surgery (very much alarmed) to seek relief for his right eye. He stated that a few hours previous he was blowing his nose, when his eye-lids suddenly swelled up so that he could not see. So altered was his appearance that although an intimate friend I did not recognise him.

On examining the lids I found that the cause of the swelling was air in the cellular tissue, and at once concluded, that it must be produced by rupture of the lachrymal sac.

I put on a graduated compress, over the lachrymal sac, till I had both lids covered. This compress I removed on the third day, when I found that all the swelling had disappeared. There never was any return of it.

tant that the patient should avoid all exciting causes. The local treatment that I have found to answer most effectually, is brushing the part with a solution of veratria, counter irritation between the articulation of the lower jaw and mastoid process, together with dry cupping on the temple and nape of the neck; anodyne linaments, pressure, and electricity are worse than useless.

Morbid Nictitation.—Mr. Mackenzie, in his Practical Treatise on Disease of the Eye, says that natural nictitation is performed chiefly by the alternate relaxation and contraction of the levator palpebræ superioris. Now I conceive that such is not the case, because then the action must necessarily be confined to the upper lid, whereas there is action in both lids; for every time the eye shuts, the lower lid is seen to move upwards and inwards,—(See Physiology of the orbicularis and levator muscles, Chapter 3.) Consequently there is in natural nictitation, contraction and relaxation of the orbicularis palpebrarum, as well as of the levator palpebræ. These actions in their natural state are involuntary, and nictitation is a morbid increase of them, of which the patient is conscious, without the power of preventing them; the spectacle of a person thus affected is a truly distressing one.

Causes.—The causes are the same as those mentioned in the last disease, except where the morbid nictitation is occasioned by an eye-lash or some foreign body touching the eye-ball.

Treatment.—If there be a foreign body touching the eye, it must, as a matter of course, be removed, in every other case the treatment will be the same as that mentioned in the preceding disease.

Blepharospasmus.—This disease is a painful involuntary spasmodic contraction of the orbicularis muscle, by which the eye-lids are shut and squeezed tightly upon the eye-ball, defying every effort of the levator palpebræ (although

it be in a perfectly healthy state) to raise the lid, even though it should be assisted by the fingers of a surgeon.

The best example of this disease, is seen in the effect produced when an irritating foreign body gets under the eye-lids, or what is so constantly observed in strumous ophthalmia.

Causes.—The direct cause of this disease is the morbid irritability of the ophthalmic branch of the fifth pair of nerves, producing a reflex action of the orbicularis muscle by means of the portio-dura of the seventh pair. The remote causes are numerous,—foreign bodies in the eyes; scrofulous conjunctivitis, which is accompanied by photophobia, particularly when the eyes are exposed to a strong glare of light—over-working the eyes upon minute objects; disordered state of the digestive organs, uterus, or brain: or a general disordered state of the nervous system. A disordered state of the portio-dura may produce the disease, without its being accompanied with either pain or photopsia.

Treatment.—Removal of the cause is the cure of this disease. If neither a foreign body under the lids, nor strumous ophthalmia, be the cause, the digestive organs, uterus, or brain, should be particularly attended to: should the disease occur without the surgeon being able to trace any cause, the general treatment will consist in emetics, purgatives, tonics, anti-spasmodics, air, exercise, and wholesome food. The local treatment consists in counter irritation applied behind the ears, to the temples and nape of the neck, &c., and anodyne fomentations to the eye-lids. Dr. Jungken recommends a small continuous stream of cold water, impregnated with carbonic acid gas, to be directed against the eye by means of a syringe or syphon. I know nothing of this last remedy: all sorts of fumigations I have tried with little good effect, but of these I found camphor the best. I believe that brushing the lids once a day with the solution of veratria constitutes the most efficacious local application.

Paralysis of the Orbicularis Muscle.—When the orbicularis muscle of the eye becomes paralysed, all the muscles of that side of the face become similarly affected.

Symptoms.—The patient has no voluntary power over the eye-lids, the upper lid being held up by the levator palpebræ, the lower lid hanging down, and in some degree everted, suffering the tears to fall over it and run down over the cheek. If the patient closes the lids with his finger, on removing his hand they at once regain their original gape. As soon as the patient goes to sleep the levator palpebræ becomes relaxed, the upper lid drops down, and the eye is covered, with the exception of that part which should be covered with the lower lid,—(see Physiology of the Orbicularis palpebrarum muscle, Chapter 4.)

Consequences.—From the eye being exposed, its mucous covering becomes dry and inflamed, which generally terminates in nebula. As the conjunctiva is not deprived of feeling, the patient suffers much pain from foreign bodies getting on it.

Causes.—The direct cause is paralysis of the portio-dura, which may be produced by many remote causes. The portio-dura nerve may be diseased, or injured, while in the cranium, when passing through the canal of Fallopius, or after having escaped from it, concussion of the brain, effusion of blood into the cranium, or abscess or tumour of the cavity, may press on the nerve in its first stage, and paralyse it. Disease of the middle ear, will injure it in the several parts of its course, and in the third part of its course it is exposed to many causes of paralysis, such as tumours, and abscess in the angle of the jaw, and wounds, particularly in surgical operations. One of the most constant exciting causes is a cold blast of wind on the side of the face, to which people are liable to be exposed in travelling, or even in sitting at an open window.

Treatment.—The treatment must be particularly directed to the removal of the exciting cause whatever that may be ; this being accomplished means must be taken to restore the nerve to its healthy condition, for which different modes of treatment have been recommended, but that which I have been most successful with, is an occasional purge of croton oil, followed up with quinine as a tonic, at the same time treating the disease locally by counter irritation at the angle of the jaw, brushing the course of the nerve with the eight grain solution of veratria every morning, and using electricity by insulating the patient, and drawing sparks along the course of the nerve. Several recommend mercury ; it may be given as an alterative, but if there be scrofula or disease of the ear, I would not either give or recommend it.

Ptosis—Lapsus Palpebræ Superioris.—Ptosis is an inability on the part of the patient to raise the upper eye-lid. The consequence of which is, that, if both eyes are affected, he is blind, and if only one eye is affected he is blind of that eye, although the organ of vision may be perfect.

Causes.—This disease may be either congenital or hereditary, in addition to the many other causes which may produce it ; it may be caused by relaxation and extension of the common integuments of the eye-lid ; if such be the case the patient will be able to raise the lid, if the redundant portion of integuments be taken hold of between the finger and thumb, so as to remove the weight from the lid. Wounds of the levator muscle may also produce ptosis, particularly if they are badly united. The worst form is that caused by paralysis of the levator muscle, or rather by paralysis of the nerve which supplies it, which nerve is a branch of the third pair : a node on the edge of the orbit is not an unusual cause of this disease ; and sometimes it is only a symptom of disease of the brain.

Treatment.—If the cause be relaxation of the integuments, the cure will be made by removing a transverse fold

of the integuments, and afterwards uniting the edges of the wound with stitches, and for this purpose there should be a strip of the integuments left at the edge of the tarsis to hold the stitches. The operation is performed by taking hold of the redundant skin with a forceps of broad extremities, or between the finger and thumb; the portion so held may then be removed with one or two strokes of a pair of scissors or a scalpel, after which the edges of the wound are to be brought together by means of a couple of stitches. The criterion by which the surgeon knows whether he has taken up a sufficient quantity of integument or not, is that the patient is enabled to open or raise the lid while the integuments are being held in the operator's hand. When ptosis is caused by a wound of the eye-lid it is presumed that the third pair of nerves is divided. In such a case, Mr. Hunt, of Manchester, proposed to attach the lid to the occipito-frontalis muscle, in order that the lid might be raised by it. The mode of operating is similar to the one just described, except that a greater quantity of integument is removed,—that is to say, all the integument which extends from a little below the eye-brow to within a third of an inch of the edge of the lid; a large elliptical wound is left, the edges of which are to be united by stitches. It appears that Mr. Hunt was successful in this mode of treatment, but he afterwards remarks that it is not warrantable, in consequence of the injury it causes to the fifth pair of nerves, which lays the foundation of amaurosis; nevertheless, J. B. Curling, Esq., performed the same operation, and it would appear, with success.

It is impossible to lay out any particular plan of treatment when there is paralysis of the levator; it must be suited to the causes, of which there are many. If the paralysis continue after the cause is removed, or if none can be found to account for the paralysis, then much may be done by a mixed local and constitutional treatment. I

have found a purge of croton oil, followed up with quinine, or hydriodate of potass, a very effectual general treatment ; and I found the best local treatment to be brushing the lid every morning and evening with the eight grain solution of veratria,—in *conjunction with electricity*.

Where it occurs in children it may be generally traced to derangement of the digestive organs ; I have constantly found such cases yield to a smart purge of calomel and rhubarb.

When the case is congenital the only treatment from which any benefit can be expected, is that recommended where the cause is a redundant quantity of integuments. The only cases of this description that I ever heard of, are three that are reported in an Italian Journal ; the cause of the disease was in each instance the same, viz :—a flattening of the superciliary ridge. When all means have failed for the cure of ptosis, Mr. Gerrold recommends the making an artificial pupil through the lid,—the operation to be performed as follows :—after introducing a small piece of flat wood, (previously well oiled underneath the superior eyelid, a crucial incision is to be made down upon it through the lid exactly opposite the pupil ; the four flaps of skin thus formed are to be dissected off, and the mucous membrane is to be turned outwards and fastened to the skin from which the base of the flaps had been removed : thus the mucus membrane forms the circumference of the artificial opening. He recommends that ever after, the patient should wear spectacles.

I have never met with such an intractable case of ptosis, except where there was slow organic disease going on, which finally killed the patient ; but should I happen to meet a case of this kind, I would prefer taking a semi-circular piece out of the edge of the lid, making the notch sufficiently deep to come opposite the pupil.*

* Since the above was written I find that Mr. Wilde reports, in the tenth

Epicanthus.—This is a congenital fold of skin, projecting from the sides of the root of the nose, over the inner angle of the eye, so as to conceal the caruncula lachrymalis,—the free edge of the fold being crescentic, and its extremities continued into the upper and lower eye-lids. To such a malformation, Dr. Ammon gave the name of *epicanthus*: it is generally to be seen in very young children having a flat bridge to their nose; as they grow older, the bridge of the nose in some instances becomes more prominent, and the malformation disappears; should it not, which is oftener the case, the operation for its removal recommended by Dr. Ammon is both simple and successful, viz:—to cut out an elliptical piece of skin, about one inch in length, from the base of the nose, and between the *epicanthi*; after which the edges of the wound are to be brought together with a twisted suture. The operator can decide upon the quantity of integuments necessary to be removed, by the taking hold of it between the finger and thumb, and raising as much of it as will remove the *epicanthus*.

Lagophthalmos.—This is a shortening of the eye-lid, the result of either injury or disease; it may or may not be

number of the Dublin Quarterly Journal, two cases of *congenital ptosis* and also *phymosis*, or congenital narrowing of the *rima palpebrarum*. There is also a good wood cut given of one of the cases that came under his observation.

The following case, as the result of syphilitic node, will be found interesting.—E. B., aged 29, consulted me, September 11th, 1849, for an affection of his eye, I found he had *ptosis* of the right eye-lid for three months, had not the slightest power over the lid even to stir it in any way. Had suffered much from secondary syphilis, and been under treatment with three different doctors, all of whom gave him mercury. On examination, I found he had a node on the orbital edge of the *os-frontis* a little external to the supra-orbital foramen. He attended me every day for nearly three months, when I discharged him so far cured, as to be able to raise the lid nearly as well as that of the left eye. The node was entirely absorbed. The local treatment consisted in painting round the upper part of the orbit every morning for three weeks, with the tincture of iodine, and the rest of the time he attended I brushed the same part every morning with the solution of *veratria*. I also used electricity every morning during his attendance. The constitutional treatment was to take a table-spoonful of the ioduretted iodide of potassium three times a day; the use of which I recommended him to continue after he left me.

accompanied with eversion. A person with this deformity cannot close the eye-lid, hence the name lagophthalmos, or hare eye, from the supposition that hares sleep with their eyes open. The evil consequence of such a state of the eye-lid is, that the eye being constantly exposed to light, air, particles of dust, &c., the conjunctiva and cornea become inflamed, and the general result is opacity of one or both of these parts.

Causes.—Wounds or burns of the eye-lid or eye-brow, or caries of the bones of the orbit, are the general causes. In the two first the lid is shortened by the cicatrix formed when the injured part is healing. In the latter there is adhesion of the lid to the bones of the orbit.

Treatment.—Time seems to do much in such cases, particularly in adapting the eye in some degree to the loss of its natural covering.

If a cicatrix be the cause of the shortening, I consider the best mode of treatment is that recommended by Mr. Wharton Jones, nevertheless the success of the treatment will depend in a great degree upon the looseness of the cellular tissue in the eye-lid, eye-brow, and forehead. If the shortening is combined with eversion, previous to performing the operation, about to be described, the swollen conjunctiva should be removed in the way mentioned under the head of ectropium.

For a few days before the operation, the cicatrix should be constantly rubbed over the cellular tissue, for the purpose of loosening it. The operation is performed as follows :—Two incisions are to be made, with a sharp scalpel, through the skin, one from each angle of the upper eye-lid,—these incisions to converge, as they ascend, till they meet at a point on the forehead, about one inch above the eye-brow ; the triangular flap thus formed is to be pressed down, without detaching it from its subjacent parts, till by the stretching of the cellular tissue the eye-lid is brought to its natural

position ; this will leave a gaping wound of a triangular shape at the apex of the flap, the edges of which wound are to be brought together by means of the twisted suture, so that this part may heal by the first intention, and thereby prevent the recurrence of contraction.

After the operation the lid should be kept closed and on the stretch for a few days, by means of a compress and bandage.

When there is adhesion of the lids to the edge of the orbit, from caries or any other cause, the above treatment is the best in addition to freeing those adhesions with the knife by a subcutaneous incision, and afterwards using such mechanical means as will keep the lid on the stretch.

In addition to the treatment already mentioned, Mr. Mackenzie recommends cutting a wedge shaped piece out of the whole thickness of the eye-lid, the base of the wedge at the edge, and then to have the edges of the gap brought together by sutures so as to cause union by the first intention. He says, this will make the lid sit close to the eye-ball, and counteract any tendency there might be in it to again contract towards the edge of the orbit. I must confess I do not see how such a result could be expected ; if indeed the lid was everted, as well as shortened, it would alter the case, but even then great caution and judgment would be required, for if the piece removed was too large, it would produce the opposite state, viz:—ectropion or inversion.

Ectropium or Eversion of the Eye-lids.—There are two varieties of this disease. In the first variety only one cause exists for it, while the same cause with an additional one, operates in producing the second.

The first variety of ectropium is that which is caused by a morbid swelling and elongation of the lining membrane of the lid, or lids, which generally commences in the lower and extends to the upper, although it may be confined to

either. When confined to the lower lid the lining of it rises in the shape of a semi-lunar fold between the ball of the eye and the lid, everting and depressing the latter as it continues to increase. When both lids are diseased, the swelling assumes an annular shape, and the eye appears as if sunken; finally the lids become everted, causing great pain and deformity; this swollen membrane becomes inflamed, tears and mucus pass over the inferior part of it down upon the cheek, causing it to become excoriated. The eye, from exposure, becomes dry and inflamed, and if allowed to continue long in this condition, the termination will be ulceration, and destruction of the cornea.

When the lower eye-lid only is everted, the eye-ball does not suffer much, as it has its covering, namely the upper lid. This variety of ectropium is generally occasioned by obstinate chronic inflammation of the conjunctiva, such as is found in scrofulous subjects, or those whose eyes have been attacked by small pox. An eversion of the upper lid is frequently caused, in infancy, by the awkwardness of persons cleansing and examining the eyes of children affected with purulent ophthalmia, the screams of the child aiding to produce the eversion; the friends complete the mischief by neglecting to bring the child to a surgeon who can reduce the eversion, until the membrane has become swollen and strangulated.

The second variety of ectropium is that which arises from contraction of the integuments of the eye-lids, or the neighboring parts, after which the palpebral conjunctiva tumefies, and presents the same appearances that are seen in the first species. Any of the causes which produce shortening of the lid, will give rise to this form of ectropium, such as scars, abscess, burns, excoriations, &c.; even the first species existing in the lower lid is very liable to run into the second, as the tears and mucus passing over the cheek cause it to become excoriated, and, if allowed to go on will finally terminate by forming a cicatrix.

The surgeon should be able to diagnose between these two varieties, which is not at all times so very easy, but he will always find that the history of the case will assist him. In the first species the skin of the eye-lid or adjoining parts is not generally disfigured with scars, and if the everted eye-lid be pressed towards the eye, with the finger, it will be seen that it easily covers the eye-ball. In the second species of this disease not only will a cicatrix be obvious, but there will be evident shortening of the lid, and if pressure be made on the swollen conjunctiva, in the way already mentioned, although the lid may yield, it will not cover the globe of the eye as in the first species. It will be easily seen whether the margin of the lid is adherent or not to the orbit.

By this time the careful reader must have observed, that the first species of ectropium is a pushing of the lower lid downward, or the upper lid upward, by the swollen conjunctiva; whereas, in the second species, the lid is dragged up or down, (according to the lid affected,) by the cicatrix on the external part.

An eversion of the lower lid is sometimes met with in old persons, the lid appearing to fall down simply for want of tenacity or support, instead of being either pushed or dragged down. In these cases the punctum is turned out, the cilia are destroyed, or there are only a few weak ones remaining, the edge of the lid becomes rounded, and the tears and mucus pass over the cheek. At first the palpebral conjunctiva, from being exposed, is tender and irritated, but finally becomes hard and nearly insensible, so that the patient will pass his fingers over it without feeling any annoyance: after some time the cheek becomes excoriated, from the tears and mucus passing over it, which causes the case to terminate in the second species of ectropium, but with less swelling of the palpebral conjunctiva.

Prognosis.—If the eversion be of the first variety the surgeon may encourage the patient, and assure him that the deformity may be removed, at least in a very great degree, by an operation; but if it be of the second variety, the fewer promises he makes the better, as success is by no means certain under the most skilful treatment. In that variety which occurs in old persons there is little hope of a successful result.

Treatment.—When a child is brought to a surgeon with its eye-lid everted, from the cause already mentioned, he should take hold of the eye-lashes between the index finger and thumb of both hands, having previously anointed the eye-lid, and squeeze from it as much as possible of the effused fluid, then suddenly bend its edge towards the eye-ball, taking care at the same time to draw the lid a little from the eye, and with the points of his thumbs to push up the swollen conjunctiva. When the lid is thus restored to its natural position, a compress and bandage should be applied, to prevent a relapse.

When the inflammation is very great, and the child irritable, recourse must be had to leeches or scarification of the inflamed conjunctiva, followed by soothing applications, and a smart purge. After the inflammation is thus abated the lid should be restored to its natural position in the manner just mentioned. Many modes of restoring the lid to its proper position, in the first species of ectropium, have been recommended. Scarpa would remove the fungous growth of conjunctiva by the frequent application of the nitrate of silver. Beer preferred the daily application of the tincture of opium, which after a time might be strengthened by the addition of naphtha; when this treatment failed, he had recourse to the nitrate of silver. Both of these surgeons agreed in opinion, that when the eversion was considerable the best and surest treatment, was to excise the whole of the fungous swelling with a pair of scissors or a bistoury.

Other escharotics have been extolled as well as the nitrate of silver, such as sulphuric acid, &c.; but I think that, when an escharotic is to be used at all, the best is the nitrate of silver, as it is more under the control of the surgeon. There is one evil that may be produced by the use of either the knife or an escharotic, and must be cautiously guarded against, viz:—inversion by the removal of too great a quantity of the conjunctiva.

When the surgeon determines on excision, the mode of operating is as follows: The patient being seated opposite the light, and the lids being held in their everted position by the fingers of an assistant, who supports the head of the patient with his chest, the operator takes hold of the fungous growth on the lower lid, at the internal canthus, with a sharp hook or pair of forceps, which he holds in his left hand (supposing the eye to be operated upon to be the right, and that both lids are everted,) then with a small sharp bistoury or pair of scissors, which he holds in his right hand, he removes the fungus clean off the lid; he then pursues the same course with the upper lid, taking care not to wound the punctum in either. The object in beginning with the lower lid is to avoid the annoyance the effusion of blood would create, if the operation were commenced on the upper. After the bleeding ceases, which is generally very soon, under the use of cold water and a sponge, the eversion should be reduced, and the lids restored to their natural position, and kept there by mechanical means, for which reason the lids should be closed and kept so with a few strips of adhesive plaster* and a compress and bandage, all of which may be removed after twenty-four or thirty-six hours, when, generally speaking, the lids will be found to retain the position, or very nearly so, in which they had been placed. The after treatment consists in keeping the eyes bathed with a little milk and warm water

* The cleanest and best adhesive plaster is the isinglass on oil silk.

for a few days, and afterwards, if it be found necessary, more of the thickened membrane may be destroyed by the application of the nitrate of silver; at all events its application will secure a strong cicatrix. To ensure that no relapse takes place, it will be necessary to remove the chronic conjunctivitis, which was the original cause of the deformity.

If the surgeon or patient prefer trying escharotics before having recourse to excision, and the nitrate of silver be used, it should be applied every third or fourth day in the following manner:—The fungous growth should be first wiped dry with a piece of fine sponge or dry rag; then the pure pencil of caustic should be passed over its surface, which instantaneously causes it to become white, after which a little cold water or milk may be allowed to pass over it, by means of a syringe or camel-hair-brush. The best way to apply sulphuric acid is with a silver probe or wooden spatula; a greater quantity of water is necessary after it has been applied, than after the use of the nitrate of silver.

For that description of eversion of the lower lid which occurs in old persons, very little can be done. It has been recommended to shorten the lid transversely by removing a wedge-shaped piece out of the whole thickness of it, the base of which would be at the edge of the lid, then to bring the gaping wound together by means of sutures; and thereby (say those who recommend it) prevent the lid from falling down. For my own part I must confess I have never seen any benefit arise from this treatment, but what I have found to give most relief was the daily application of the ten grain solution of the nitrate of silver.

In the second variety of ectropium many modes of treatment have also been recommended, all of which appear to have both failed and succeeded at different times, the success

seeming to depend more upon the *quantity* of integuments lost, than upon the mode of operating.

All authors agree that whatever operation be performed, it is first necessary to remove the thickened conjunctiva, in the manner already described for the first species of ectropium. Indeed, both Scarpa and Beer pursued the same treatment for both varieties, with this addition, that, in the second species, they endeavoured to stretch the lid by mechanical means, having, previously to the operation, softened it by the application of emollient poultices, and, after the operation, kept the lid and cicatrix rubbed with oily embrocations. Both these men were decidedly of opinion that dividing the cicatrix was of no permanent benefit, but rather the reverse, since, when the wound healed, the contraction was always greater; and most certainly their idea was a correct one, for where there is actual loss of substance, and consequent shortening of the lid, cutting it cannot make it longer.

After the ectropium was reduced, to prevent its recurrence, Sir William Adams proposed that a wedge-shaped piece should be taken out of the lid. For the mode of doing this, see Ectropium in old persons.

The treatment most valued in the time of Celsus was, to make an incision through the cicatrix down to the cartilage; then, causing the wound to gape, drawing the lid downwards, after which the wound was filled with lint, and healed by granulation. This treatment was found to answer well, so long as the healing process went on, but when the granulations were absorbed, and the cicatrix formed, the deformity was greater than ever.

The operation of *Catoplasty*, or cutting away the cicatrix, and transplanting sound skin in the wound, has been found of great service not only in cases of ectropium, but in contraction of the neck, fore-arm, hand, or any other part of the body. Professor Mutter of Philadelphia says that it is

the operation of all others entitled to our confidence, especially in cicatrices of the neck, cheek, eye-lids, nose, lip, &c. The following are his words:—"In all such operations we are governed by the same principles, and pretty much the same mechanical details; they consist in,

"1st. Dividing the cicatrix so as to produce a raw surface in some parts of its extent, or cutting it entirely out, as proposed by *Hildanus*.

"2nd. In applying to the raw surface a piece of healthy skin, taken from the neighboring parts.

"3rd. In attaching this skin by suture to the margins of the wound in which it is inserted.

"4th. In approximating the edges of the wound, from which the skin has been removed.

"5th. In separating, by appropriate agents, the parts too closely approximated, and keeping them in this condition some time after the flap has united.

"6th. In applying oleaginous frictions, and motion to the new parts, so as to give them flexibility and softness."

This operation failed in the hands of Jungken, but succeeded with Lisfranc, Dieffenbach, Ammon, and Frick.—Dieffenbach called the operation *blepharoplastic*.

The only difference of opinion that seems to have existed between these surgeons, was as to where the new part should be taken from, the shape the piece should be of, and whether it should be altogether detached, previously to its becoming adherent to the part into which it is ingrafted. If the eye-lid is the part affected, I would prefer taking the new lid from the temple, as being a part easily healed, and sufficiently near for the purpose; as to the shape and size of the piece, it should agree with that of the gape it is designed to fill, which varies in different cases. There is one rule that must be always observed in the operation, which is, to preserve as much of the eye-lid as is possible, particularly the cartilage, puncta, lachrymal ducts, cilia, and conjunc-

tiva. The surgeon will do well to attend to the six rules laid down by Mutter.

The after treatment consists in the application of cold water, to prevent suppuration.

It is sometimes difficult to bring the edges of the newly made wound together, from the want of looseness in the cellular texture, or in consequence of the size of the flap removed; when such is the case it should be drawn as closely as possible together with adhesive plaster; and covered with lint.

Mr. Wharton Jones recommended the same treatment for the second variety of ectropium, as for *lagophthalmos*. The treatment I shall now mention is one which I succeeded with the only time I ever adopted it, and before I became aware that Mr. Mackenzie had spoken of it in his work, under the name of *Tarsoraphia*.

W. F., aged 30, presented himself to me with ectropium of both lids of the left eye; the whole of the ciliary margin of the lower lid, and the external half of the ciliary margin of the upper lid, were adherent to the edges of the orbit. The orbital edges of the tarsal cartilages took the place of their ciliary margins, and the palpebral conjunctiva presented a fungous mass. The cause of this deformity was syphilis, which disease had also taken away the whole of the soft palate. The treatment I adopted was as follows, —I first removed the thickened conjunctiva by means of a scalpel and a pair of forceps, in the manner already recommended when treating of the first species of ectropium; I then separated both lids from their unnatural adhesions, which enabled me to restore them to their proper position. I then pared off the ciliary edges of both lids at their external angles, to about one third of their extent, brought the raw edges together with a twisted suture, and covered the whole with a compress and bandage: on the second day I removed the two needles, when I had the satisfac-

tion to find an anchyloblepharon, of that part of the lids which I had cut, perfectly formed. The after treatment consisted in dressing the wound of the lids every day, with simple ointment and lint, till it healed by granulation, and formed a firm cicatrix. I applied to the eye every day, for some time, the ten grain solution of the nitrate of silver. My object in this case was fully effected, which was, to prevent the lids from becoming again everted by making one act against the other.*

Trichiasis and Distichiasis.—I consider these two as one and the same disease, or rather one disease split in two by authors, for what purpose I cannot conceive. *Trichiasis* is defined to be a growing of the eye-lashes against the ball of the eye; and by the term *distichiasis* is meant a double row of eye-lashes, with the inside row growing against the eye-ball; I believe, however, that what is called a double row is simply an irregularity of the bulbs of the hairs, causing one hair to turn in and another to turn out, thus presenting the appearance of a double row.

* The following case of ectropium is reported by Mr. Wilde in the tenth number of the Dublin Quarterly Journal of Medical Science, page 473. *Ectropium.*—We have very little to record on this subject. The following case, which we treated in the year 1844, by a new method of operating, possesses sufficient interest for its insertion here. The subject of the deformity represented in the accompanying illustration. A girl aged fourteen years had a scrofulous abscess over the malar bone, near the edge of the orbit, when about five years of age. A small portion of the bone had exfoliated; the integuments became inverted during the subsequent healing process, so that the skin and periosteum were intimately united. By this means the lower lid was drawn down from the globe, and its outer portion greatly everted. The conjunctiva presented the usual red villous appearance, which it assumes when thus exposed for any length of time. When first examined we found the integuments so intimately attached to the bone that it did not seem possible to insert anything between them. For upwards of a fortnight the patient, by our directions, rendered the parts more moveable by drawing the adjoining skin in different directions, so that some cellular membrane seemed thus to have been fitted as it were, between the bone and the thin layer of skin by which it was covered. A small narrow-bladed and double-edged knife, such as that used for the subcutaneous section of tendons, was then introduced at the distance of nearly an inch on the outer side of the cicatrix, passed obliquely down to the bone, then pushed forward to the outer angle of the attachment, at which period of the operation the parts both above and below the cicatrix were made as tense

In either case the hairs constantly rubbing against the eye, act as a foreign body, producing irritation, inflammation, and finally opacity of the cornea, and even in some instances such deep ulceration as to penetrate the cornea, causing prolapsus of the iris, and sometimes entire destruction of the eye.

This diseased state of the eye-lids differs in degree ; sometimes all the lashes are turned in, more frequently the lashes of one lid and not of the other, and in other cases only part of the lashes of one lid.

Causes.—The causes which produce trichiasis, are long neglected and continued disease of the tarsal cartilages, arising from chronic ophthalmia, scrofula, small pox, injuries both mechanical and chemical, &c., &c.

Treatment.—Whatever treatment is adopted, the object should be to prevent the eye-lashes from pressing on the eye, to accomplish which purpose many modes of treatment have been recommended. The first and most simple is that which is called the palliative, but very often in young subjects it proves a radical cure. It consists in pulling out the hairs with a pair of forceps, which process is to be repeated as often as the hairs grow in a wrong direction. It is also

as possible, and stretched forwards, while the point of the knife, its flat surface being laid upon the bone, was moved in a semi-circular manner from above, downwards, and at the same time pushed forward, until the entire adhesion, and nearly half an inch on each side of it, was fully detached from the bone. As soon as it was found perfectly free, and that the lid could be restored to its normal position, the knife was withdrawn, and the small wound closed with adhesive plaster. The effusion of blood which immediately took place beneath the cicatrix, caused a tumor where the depression had existed, and care was taken that none of this blood should escape through the external aperture. A ligature was then passed through the lower lid, about a quarter of an inch from its ciliary margin, and the ends of it drawn up and attached to the forehead during the next three days. Cold applications were applied, and we had the satisfaction to find that, within a fortnight afterwards, the deformity was completely removed, the depression of the cheek filled up, and the lid restored to its natural position. The thickened conjunctiva, however, required the application of the sulphate of copper for some time afterwards. At present it is scarcely possible to trace where the deformity existed. This case is not only interesting in itself, but the means by which it was removed afford us a valuable hint in the treatment of similar deformities elsewhere."

the best treatment for adults when there are only two or three hairs turned in the wrong direction.

When the hairs are not very irregular and not very many turned in, some practitioners have succeeded in removing the disease by cauterizing the skin of the lid so as to make a cicatrix which everted its edge, and thus turned the lashes outward. This mode of treatment is effected by placing a bone or silver spatula under the lid, then the actual cautery (which may be a knitting needle heated to a white heat) should be applied along the skin of the lid parallel to the eye lashes, and about the twentieth of an inch from them. The greater the extent of surface destroyed, the more will the edge of the lid be everted; great care should, therefore, be taken not to make a greater eschar than is necessary, lest the lid should be too much everted; the length of the eschar will depend upon that of the inversion. The following treatment is recommended by Mr. James Hunter, of Edinburgh: having ascertained the exact position of the hair or hairs inverted, take a lancet or iris knife, and make with it a puncture close to the base of the hair, and in the direction of its growth, to about the eighth of an inch in depth; the knife then to be moved about so as to cut the bulb of the hair, and widen the bottom of the wound, which is to be immediately afterwards inoculated with the tartrate of antimony. When so much has been done, he directs that immediately afterwards the inverted eye-lash be pulled out with a pair of forceps. The manner in which he prepared the antimony for inoculation was by dipping into it a lancet previously coated with hot sealing wax. When there is only a single hair misplaced, Mr. Mackenzie recommends a puncture to be made in the skin of the lid beyond the root of the hair, after which a speck of pure potash is to be inserted into the puncture; of course his object is the same as that already mentioned, viz:—to produce a small slough, and consequent cicatrix, which would alter the direction of the hair.

When all else fails there is a treatment that is sure to be successful, but which will, in some degree, disfigure the patient; namely excision of the edges of the lids with either a knife or a pair of scissors. When this treatment is adopted the surgeon should be particularly careful to remove the bulbs of the hairs, in excising the edges of the lids. Some surgeons do not cut the cartilage of the lid but all the parts superficial to it, after which they destroy the bulbs of the hairs by applying to them the nitrate of silver. In performing this operation the surgeon must be cautious not to wound the puncta, or the lachrymal canals.

The treatment I would advise, and which I have always found successful, is the same as that recommended for entropion—an operation which I consider an improvement upon that made by Dr. Jacob on Sir P. Crampton's operation. But when the disease is slight, with but a few irregular hairs, perhaps the best treatment is that recommended by Mr. Hunter; but circumstances must also guide the surgeon as to which mode he will adopt.

Entropion, or Inversion of the Eye-lids.—Entropion is exactly the opposite disease to ectropium, being an inversion, instead of an eversion, of the eye-lid. The evil results of this disease differ in no respect from trichiasis, as in both cases the eye-lashes are directed against the globe of the eye, although not from the same cause; the fault in this disease being in the eye-lid which is rolled in on the eye. As in trichiasis, so in entropion, one or both lids may be diseased, or only a part of either. When only one part of the lid is affected, it is generally its external angle, at least so I have always found it.

Entropion is of three varieties, viz :—*acute*, *chronic*, and *traumatic*, all of which, although producing the same effects, depend upon different causes. The first is generally found in old persons; the second in young and scrofulous children; and the third may be in either, as it is the result of injury.

In the acute form of entropion, the eye-lid is simply inverted, without any shortening, and is caused by the integuments becoming relaxed and swollen, as the conjunctiva does in ectropium; I am however of opinion that there is also an irregular spasmodic contraction of some of the fibres of the orbicularis muscle; indeed the pain produced by the cilia rubbing against the eye-ball must necessarily produce blepharospasmus. In this form of entropion the eye-lashes can be brought to their natural position, by pinching up the swollen integuments of the lid so as to take the weight off the eye-lid, but upon letting them go again the lid will roll itself in as before.

In the chronic form of entropion, the edges of the lids are thickened and irregular, the cartilage is shortened and contracted, and the lid being inverted, presses hard against the eye-ball; the integuments are tense and vascular, the cilia small and irregular.

The frequent attacks of inflammation alter the cartilage and conjunctiva, sometimes producing an ulcer and cicatrix, which shortens as well as inverts the lid. The cause of this form of entropion is, generally speaking, the neglect of long continued ophthalmia tarsi, or catarrhal conjunctivitis. Some are of opinion that in this form, also, there is irregular contraction of the fibres of the orbicularis; for my own part, I am of opinion that every time the eye is irritated there is contraction of the fibres of the orbicularis muscle.

The traumatic form of entropion is generally caused by scalds or burns of the conjunctiva, lining the lids, or its being injured by escharotics, such as quick lime or some strong metallic acid: I have never seen such a case that was not accompanied, in some degree, with symblepharon; and symblepharon can hardly exist without, in some degree, producing entropion.

Treatment.—The treatment for traumatic entropion, when combined with symblepharon is the same as the treatment

for symblepharon. When there is no symblepharon present the treatment is the same as that for the other forms of entropion.

Although entropion has been divided into acute and chronic, still, when an operation is required for its removal, few ever think of alluding to any particular kind or species. Scarpa and Beer, believing that the great cause was looseness and swelling of the integuments, recommended the removal of a portion of them, which treatment is always successful when the case is simple acute entropion. The following is the mode of operating:—The surgeon must raise with a pair of forceps so much of the integuments as to cause the lashes to stand well out, on the patient raising his eye-lids. The place held must be the centre of the lid, and this quantity of integuments, so held by the forceps, must be removed with one or two strokes of a pair of sharp scissors; this will leave a wound of an oval shape on the lid, its greatest breadth corresponding to the middle of the lid, and its narrow ends to the angle of the eye-lid. The operator must take care to leave a narrow strip of skin, close to the tarsal edge of the lid, for the purpose of holding the sutures which are to close the wound.

It is particularly recommended by Scarpa that the incision be made very close to the edge of the tarsus, for if this were neglected, he said, the operator might have the mortification of finding, after the wound had healed, that although the eye-lid was shortened from the eye-brow to the place of the incision, yet it is not equally so at the space between the cicatrix and the edge of the lid, and consequently that the edge of the tarsus would not be turned out sufficiently to keep the eye-lashes from rubbing against the eye. He recommended that the edges of the wound be brought together with strips of adhesive plaster, not stitches, and if the lid operated upon be the upper, that the eye-brow be kept pressed down for a few days by means of

a compress and bandage ; and if it be the lower lid, that a similar pressure be made against the inferior edge of the orbit, so as to keep the edges of the wound from separating. But the better to attain this object, Lagenbech, Beer, and others, recommended that the wound should be united by sutures, in which I fully agree. To insure the same result as by excision, it has been recommended to destroy a portion of the palpebral integument by the use of the actual cautery or an escharotic ; of such a mode of treatment I will only say I would never prefer it to excision, as it is more painful, more tedious, and less certain.

Mr. Lawrence recommended that this disease should be treated in the mode recommended by him for trichiasis, namely by cutting off the edge of the lid.*

Such a treatment should never be adopted until all others have failed. The treatment recommended by Sir P. Crampton of Dublin is to divide the tarsal cartilage by two perpendicular incisions, each of which should be three lines in length, and situated at each angle of the lid ; these incisions to be united by a transverse section of the conjunctiva. He then turned up the edge of the lid, and kept it in that position, during the healing of the wounds, by means of a suspensorium palpebrarum. Mr. Guthrie combined this operation with excision of a portion of the integuments. Dr. Jacob made another improvement ; he makes the two perpendicular incisions about one quarter of an inch in length, and through the whole thickness of the eye-lid ; then the transverse incision not only through the conjunctiva but through the cartilage, and also to the ciliary margin. That these wounds may not unite by the first intention he touches their edges with the sulphate of copper immediately after operating ; and for two or three days occasionally everts the edge of the lid. Dr. Newman recommended subcu-

* This is the treatment, I understand to be still adopted by Mr. Wilde of Dublin.

taneous incision for the cure of entropion ; and operated as follows :—At half an inch from the external angle of the eye he inserted a small tenotome, which he carried on to the internal angle, and then turned the cutting edge of the knife downwards, dividing the fibres of the orbicularis muscle:—the muscle of the inferior eye-lid was cut in a similar manner, the knife being inserted in the same puncture at the external angle of the lids.

M. Petrequin, of Paris, under the impression that permanent contraction of the fibres of the orbicularis was the cause of the entropion, recommended subcutaneous myotomy for its cure, and gives a case which he treated in this way with complete success. He placed the instrument on a level with the floor of the orbit, the lid being held, extended, and passed it under the skin and the orbicularis up to the free edge of the lid, taking care that no fibres escaped division superiorly ; the instrument was then carefully withdrawn, dividing the fibres, the operation being assisted by pressing on the eye-lid with the finger.

When I am satisfied that the cause of entropion is a superabundant quantity of integuments, I operate as recommended by Scarpa, with this difference, that I leave a small slip of skin next the cilia, and use ligatures to bring the edges of the wound together. In all other cases, except traumatic, whether it is *Trichiasis* or *Entropion*, my treatment is a compound of the modes adopted by Doctors Jacob and Guthrie. I make two perpendicular incisions, as recommended by Jacob, and unite them by a longitudinal incision, by excising a piece of the integuments in the manner recommended for simple acute entropion ; I then bring the edges of this last wound together by sutures, and get them to unite by the first intention ; but, following Dr. Jacob's plan, I prevent the perpendicular incisions from uniting, by touching their edges with the sulphate of copper.

The two perpendicular incisions should enclose between them the exact portion of the lid that is inverted ; but care must be taken not to wound the puncta or lachrymal ducts. I conceive that Dr. Jacob's mistake was uniting these incisions by a longitudinal incision through the conjunctiva and cartilage ; as the healing of this wound, whether by granulation or adhesion, must tend to bend the lid still more toward the eye-ball.

Symblepharon.—By this term is meant adhesion of the lids to the eye-ball, which deformity prevents the free motion of the globe of the eye, and, as I have mentioned, when treating of entropion, always produces that disease in the traumatic form, though traumatic entropion may exist without it. In the treatment of incised and lacerated wounds of the eye-lids, it is explained how symblepharon can be prevented from occurring as a consequence of such injuries.

Treatment.—All authors agree as to the difficulty of removing these unnatural adhesions, or rather of preventing them from again taking place after separation. There are three modes of treatment whereby this re-adhesion can be prevented,—firstly, by ligature ; secondly, by dividing the adhesion, and placing a plate of thin sheet-lead between the eye-lid and the eye-ball, to be kept there during the healing process ; thirdly, similar to the second, but that a fine soft piece of lint is used instead of the lead, which is much the best, and was suggested to me by Dr. Macdonell of Montreal. The ligature is the best mode of treatment, when the adhesion is small, like a band holding the lid to the ball of the eye ; it is used as follows :—a curved needle, being armed with a double ligature, is to be passed through the centre of the adhesion, as near as possible to the reflected portion of the conjunctiva ; the needle is then to be cut away, after which one ligature should be tied as close as possible to the eye-ball, while the other must be tied just as near to the palpebra ; the ends of the ligatures are to be

cut off close to the knots, and the tied parts left to ulcerate away,—which they do in a few days, and in so doing remove the adhesions which do not form again. When the adhesion is large it must be cut with a knife, and, if possible, should be altogether removed; a plate of lead, or a piece of lint the size of the wound, should then be inserted between the lid and the eye-ball, and the lids closed and kept in that position for thirty-six or forty hours, by means of a compress and bandage; at the expiration of this time the eye should be cleaned, and the lead or lint replaced if found necessary; when the lead is used it must fit the part well, and be perfectly smooth; it will then produce no irritation.

I have treated numerous cases in this way with invariable success, and I now use lint in preference to lead.*

Anchyloblepharon.—By this term is meant adhesions of the lids to each other at their edges, which is generally the result of injuries. In such a case the surgeon should with a knife, separate the lids and prevent them from becoming

*The following case of the successful removal of these adhesions must be read with interest, as it shews the value of both the lead and lint.

May 6th, 1848, John ———, labourer, æt. 28, had his eyes injured when blasting rocks in the United States, about six months before; never saw light since. On examination I found, that the eye-lids of both eyes were altogether adherent to the front of the eye-ball: nearly as close as if it had been a natural adhesion. I with much difficulty freed the eye-lids of the left eye from their unnatural adhesion. After which I at once placed a plate of lead on the front of the eye-ball, between it and the lids, and bound the lids down on the lead with strips of adhesive plaster. After three days I removed the lead. The lids never again became adherent, but there was severe inflammation of the eye-ball, which I think was owing to the extensive dissection which I made at the time, more than the application of the lead, which I have used in many other cases, where the adhesions were not so extensive, without any evil result. I removed the lead, and cleaned it and the parts every twenty four hours, and then replaced it, but I removed it altogether on the third day. The man declared he never felt the slightest inconvenience from the lead being on his eye.

About two months after operating on the left eye I operated on the right eye and treated it in the following manner;—I cut a small portion of the adhesions every third day till all was removed, which took seven times to operate; each time, after separating the adhesion, I placed a soft piece of lint in the wound, and strapped down the lid with a piece of court plaster. In this eye there never was the slightest inflammation; the eye-ball was perfectly free, the adhesions never again formed, and at the time he left me there was as much of the cornea cleared as enabled him to see his hand.

again united. This may be done by keeping them asunder by mechanical means, such as strips of adhesive plaster, &c., when the lids are thus confined the edges may be got to heal by applying to them a weak solution of the nitrate of silver twice in the day, and smearing them at night with a mild stimulating ointment.

Phthiriasis.—Phthiri, or crab-lice, have been found in the cilia and eye-brows; they produce great itching and chronic inflammation of the parts infested. The remedies are cleanliness, and bathing the parts a couple of times in the day with a weak solution of the bichloride of mercury, say two grains to the ounce. The strong citrine ointment, smeared on the part at bed time, is also a good application.

CHAPTER XVI.

INJURIES, AND DISEASES OF THE CONJUNCTIVA, SEMI-LUNAR MEMBRANE, AND CARUNCULA LACHRYMALIS.

Persons frequently complain of suffering great pain from something having got into their eye, by which term it is to be understood that a foreign body has got between the eye-lid and eye-ball. These bodies may be either chemical or mechanical, or they may have both properties. Such bodies, thus situated, produce great pain, profuse lachrymation, redness of the conjunctiva, and blepharospasmus, these symptoms differing in degree according to the amount of irritation induced, and the degree of natural irritability of the patient.

Experience proves that, in persons of nervous irritable temperament, if the most simple body touch the eye, it will produce such a spasmodic contraction of the orbicularis as sometimes to defy every attempt of the patient and the surgeon to get the lids opened. This closing of the lids and the flow of tears, are efforts of nature to remove the offending body; and they sometimes do so most effectually, by directing it to the internal canthus of the eye, where the caruncula lachrymalis and semi-lunar membrane help to expel it: but if the offending body should be of such a nature as to stick into the conjunctiva, this effort of nature would only render matters worse, by fixing it there more firmly.

The bodies which generally adhere to the conjunctiva are bits of stone, glass, straw, husks of seed, parings of nails, sparks of steel or iron, splinters of wood, &c. It is a remarkable fact that all these bodies, generally, adhere to the corneal or palpebral conjunctiva, and rarely to the sclerotic conjunctiva, which can be only accounted for by

the fact, that the looseness of the sclerotic conjunctiva renders it much more difficult for such bodies to pierce it.

As the upper lid is constantly passing over the eye-ball, a foreign body will cause greater irritation when in it than in any other part of the conjunctiva. The substances which produce chemical injuries of the conjunctiva are, generally speaking, quick lime, metallic acids, &c.

Treatment.—When a foreign body gets into the eye, if it be either mechanical, or mechanical and chemical, it should be removed as soon as possible, and if chemical only, it should be neutralised or diluted so as to leave its action inert.

After it has been removed or destroyed, if inflammation remain as the result of the injury, it must be treated on general principles, as described under the head of conjunctivitis, in the article on ophthalmia. When a foreign body gets into the eye, the natural thing for every person to do, is to run to cold water for relief, and this very frequently destroys the patient's eye, particularly if the body be quick lime: I have seen in such cases the eye destroyed in a few minutes. When a patient comes to me with lime on his eye, the first thing I do is to pour sweet oil over the whole part; this I find not only gives the greatest relief, but collects the particles of lime together. I then, with a camel-hair brush dipped in the oil, brush off all the lime I can, as quickly as possible, holding at the same time the lid out from the eye-ball, and sweeping the brush round the reflected portion of the conjunctiva, from the external to the internal canthus. I then evert the lids one after the other, and pick off any portion of the lime that may remain, however small. Sometimes the lime becomes so imbedded in the conjunctiva, that it requires to be picked out with a cataract needle.

If the foreign body be only mechanical, and the blepharospasmus is very great, it may be allowed to remain till

the next day, applying to the eye during the night a warm poultice of bread crumb sprinkled with a little tincture of opium, tincture of hyosciamus, or spirit of camphor: benefit will also be derived from giving the patient an opiate. But once in my practice have I found it necessary to have recourse to blood-letting, and then I bled the patient till he fainted, when it was easy enough to open the lids and remove the foreign body, which was a chip of rosin that was sticking in the cornea.

The treatment I now adopt, when the spasmodic action is very great, is to put the patients slightly under the influence of æther or chloroform, rendering them partially insensible, and thus get the lids relaxed. A fact that should make the surgeon very careful in his examination is, that foreign bodies sometimes get on the eye that are so small as to require a magnifying glass to enable the surgeon to see them. He should evert both lids one after the other and search well among the folds of the conjunctiva, and make sure that he leaves no particle behind.

The best mode of everting the upper lid is to take hold of the cilia between the finger and thumb of the left hand, supposing the lid to be everted is that of the left eye, and pull it downwards and forwards, then with a probe, held in the right hand, pressure should be made on the outside of the lid, on a line with the reflected conjunctiva, and, while the pressure is making, the left hand should be raised suddenly upwards, and thus the lid will be everted.

When a foreign body is stuck into the cornea, to have it removed the lids should not be everted, but the upper should be kept raised against the arch of the orbit, with the fingers of an assistant, while the lower is depressed with the index and middle finger of the operator; then the particle may be picked off the cornea with a cataract needle.

When removing such bodies I always stand behind the patient and support the upper lid with one hand, while with the cataract needle which I hold in the other I remove the foreign body. This prevents the necessity of an assistant, while it gives a greater quantity of light to the eye. A small particle will sometimes remain for months on the cornea conjunctiva, without producing any irritation, till finally a little abscess forms round it, and it is cast off with a little slough. The evil results of any foreign body getting between the eye-lids and eye-ball will be to produce inflammation in a greater or less degree; if the body acts chemically it may at once destroy not only the whole conjunctiva, but the entire eye-ball; at all events, some part of the conjunctiva is sure to suffer, terminating, most probably, in symblepharon, or opacities of the cornea. There is nothing that causes such a deep stain as gunpowder, or such an incurable opacity, as that which results from applying acetate of lead to the abraded conjunctiva, where it becomes deposited, and leaves an opacity of a chalk-like appearance, from its being transformed into a carbonate of lead.

Subconjunctival Ecchymosis.—The cellular tissue under the sclerotic conjunctiva, often becomes the seat of an ecchymosis, but no matter how much blood may be extravasated, it will not detach the conjunctiva from the cornea nor from the palpebræ; therefore the protruded sclerotic conjunctiva forms a cushion round the cornea, making the latter appear small and shrunken.

Causes.—Blows and wounds are the general causes, but cases have been known to occur from violent fits of coughing and fits of epilepsy.

Treatment.—The only treatment generally required is a good purgative, with astringent lotions applied to the eye.

Subconjunctival Emphysema.—Air will sometimes escape from the nose through a fractured portion of its parietes,

and make its way into the subconjunctival cellular tissue. The treatment in such a case is to evacuate the air, occasionally, by means of a slight puncture, till the fracture is united.

Subconjunctival Phlegmon.—The subconjunctival cellular tissue is sometimes the seat of phlegmonous inflammation, but it rarely runs into suppuration; when it does, the matter should be at once evacuated. The symptoms are, the conjunctiva becoming red and thickened, which is followed in a few days by the presentation of a small prominence.

Subconjunctival Œdema.—It is stated by Mr. Mackenzie that this disease sometimes occurs on the temporal side of the eye-ball, in small patches, and that it causes the sensation, as of the presence of a foreign body. He asserts that the œdema generally shrinks under the application of the nitrate of silver or wine of opium, but sometimes requires to be snipped off with a pair of scissors; particularly, as the patches often degenerate and become cartilaginous. I have never seen any such cases as those he describes; indeed the only œdema of the conjunctiva that I have seen is that inflammatory œdema which resembles in every respect subconjunctival ecchymosis except in color, the œdema being of an amber color and apparently sero-gelatinous. This is not in itself a disease, but accompanies severe ophthalmia; I have found it in severe cornitis and general ophthalmitis.

Pterygium.—This term is applied to that preternatural little membrane which is of a triangular form, its apex being always towards the cornea, and its base generally towards the caruncula, but it may be either at the external canthus, or the superior or inferior part of the eye. One, two, three, or four pterygia may exist together on the same eye, the apices of all meeting on the centre of the cornea; but it is very seldom that there is more than one. In two instances Beer saw two on the same eye, and once he saw three. Wardrop saw two on each eye of the same person. I have

seen but one case where there were two on the same eye, but I have seen many cases where there was one on each eye. The distinguishing characteristics of pterygium are, its triangular shape, the base lying on the sclerotic conjunctiva, and the apex on the cornea ; if the eye be turned towards the base of the pterygium, the pterygium and the conjunctiva form folds. It is the only growth on the cornea that can be taken hold of with a pair of forceps and raised into a fold, all other excrescences of the cornea being adherent to it. Pterygium is divided into two classes, viz :—the pterygium *tenue* of Beer, or the membranous pterygium. The pterygium *crassum* or the fleshy pterygium. The first of these is a semi-transparent, thin, greyish membrane, not having many visible vessels. The second is a thick red fibrous mass, very like muscle, and prominent on the cornea, where it seems to terminate in a tendinous-like substance. Pterygium is perfectly free from pain, nor is there any new production of the eye, as there would appear to be, but only an alteration of the thin transparent membrane that covers it, and which is converted by chronic ophthalmia into a thick opaque tunic.

Prognosis.—It never gets well spontaneously, and is not curable, unless in the very incipient stage, except by operation ; its removal by operation will always leave a cicatrix of more or less extent, which is of but little consequence.

Treatment.—In the incipient stage, pterygium may sometimes be removed, by the daily application of the nitrate of silver solution, varying in strength from four to ten grains. If this treatment does not succeed, recourse must be had to operation, which, after all, is the least painful as well as the surest treatment. Some recommend that only so much of the pterygium *tenue* be removed as covers the cornea ; but that the pterygium *crassum* should be removed to its very base. I would recommend the last treatment for both species.

Mode of Operating.—The patient being properly seated, and an assistant having the lids held apart, he is to be directed to turn his eye towards the side corresponding to the base of the pterygium ; then the surgeon should take hold of the apex of the membrane at about a line and a half from its point, in a pair of sharp toothed forceps, where the membrane is thus pinched into a fold ; it should then be gently raised off the ball of the eye, till a sensation is borne to the fingers of the surgeon, as if something had given way, which indicates the detachment of the pterygium from the delicate cellular membrane that connects it with the cornea. The surgeon must then with a knife or pair of scissors, dissect off this fold as closely as possible from the eye-ball, beginning at its apex on the cornea, and terminating at its base on the sclerotica, from which it must be removed with one stroke of a pair of curved scissors, the concavity of which should be turned towards the cornea, and a semi-lunar incision will be thus made, having its concavity towards the cornea. After the operation the patient may go about his ordinary business ; cicatrization is generally complete in from fourteen to twenty days. If during that time the eye feels stiff and uncomfortable, it may be bathed in milk and water.

Pinguecula.—This is a little yellowish colored tumour, situated partly in the conjunctiva, and partly in its cellular membrane ; it is generally close to the cornea, but on the white of the eye. It rarely gives any annoyance, but if it should, it may be taken hold of with the forceps, and removed with a pair of small scissors.

Warts of the Conjunctiva.—The palpebral or sclerotic conjunctiva is sometimes the seat of red granulated warts. I believe they never grow from the corneal conjunctiva, but those growing from the sclerotic are sometimes so large as to cover the cornea. Puro-mucous inflammation sometimes accompanies these warts, but it is not always present until

the excrescence becomes so large as to produce considerable irritation. The treatment of such warts is to remove them with a pair of scissors.

Polypus of the Conjunctiva.—The only case of this disease, that I know of on record, is one by Mr. Laurence, which he describes as about the size of a pea, and connected by a slender stalk to the inner surface of the upper eye-lid. On the 11th of March, 1848, a servant woman named Mary Smith, consulted me for exactly such an affection. The cure was simple; I took hold of the polypus with a pair of forceps, and it came off with the slightest touch; this was followed by a few drops of blood, and the patient never experienced any further annoyance from it.

Moles of the Conjunctiva.—Moles are sometimes found on the conjunctiva, even with hair growing from them. They are always congenital, and generally on the sclerotic conjunctiva. They sometimes grow so large as to prevent the lids from closing. When such is the case, or when they produce any irritation, they should be taken hold of in a pair of forceps, and snipped off with a pair of scissors, as close as possible to the conjunctiva. The after treatment consists in bathing the eye, and keeping it clear with a little milk and tepid water.

Vesicular, Adipose, Sarcomatous, and Cartilaginous Tumours.—Any of these descriptions of tumours may grow from the conjunctiva, and sometimes to such a size as to produce both deformity and suffering. The treatment of all such tumours is to remove them by excision.

Fungus of the Conjunctiva.—This is a disease both painful, destructive, and very difficult of cure. Mr. Mackenzie describes two varieties of it. I have never seen but one, and that is what he calls the first variety. It rises sometimes from the surface of the lids and sometimes from the sclerotic conjunctiva,—elevated into irregular soft masses, which prevent the lids from closing: and the secretion, from being thus

exposed to the air, becomes encrusted. The fungous mass is of a deep red color, and is apt to bleed, when irritated by a foreign substance. The pressure that it produces on the eye-ball sometimes bursts it, and destroys that organ. The only difference between this and the second species is that the latter is of a gelatinous appearance, of a light yellow or brownish color.

Treatment.—The treatment is the same in both species. If they do not yield to astringent solutions, such as the nitrate of silver or the vinum opii, escharotics may be tried, but if these be not found to have immediate effect in arresting the progress, the sooner extirpation is performed the better; and when this is done the whole fungous mass should be removed, to accomplish which it is sometimes necessary to separate the lids with a knife, at the external canthus, that they may be the more easily everted, without which the fungous mass could not be dissected out. The after treatment consists in keeping the eye bathed with a little milk and water, and if a reproduction of the fungous appears, it should be kept down by the application of the nitrate of silver. The general caution, of passing a probe, smeared with simple ointment, between the lids and the eye-ball two or three times a day, to prevent symblepharon, should not be neglected.

Encanthis.—The commencement of an encanthis is a small red soft excrescence growing from the caruncula and semi-lunar membrane, which, according to Scarpa, is granulated, and of a mulberry appearance: when it gets into the advanced stage, it emits two appendages, which run along the internal part of each lid near to their edges, the body at the same time filling the whole of the internal canthus up to the cornea. This tumor prevents the lids from closing at the internal canthus, and everts the puncta, the consequence of which is that there is a constant stillicidium lachrymarium and chronic ophthalmia. The body of the encanthis often grows as large as a marble, and even larger.

Encanthis may be either benign or malignant; the former is generally the effect of simple inflammation, the latter seems to be a scirrhous affection of the glandular substance, which if neglected degenerates into a cancerous ulcer. The malignant, is of a bluish red color, and hard, producing, when touched, lancinating pain through the eye-ball, temple, and forehead: it has a great propensity to bleed, ulcerate, and pour out an acrid discharge.

Treatment.—The benign encanthis is always curable by extirpation; but the cure of the malignant form is by no means certain. Indeed both Beer and Scarpa were of opinion that extirpation in such a case rarely proves successful, and that it is always followed by an incurable weeping, and a considerable eversion of the lower lid. However, anything is better than the danger attending a scirrhous, therefore it should be excised. The mode in which this operation should be performed, is to have the lids everted by an assistant; the operator will then take hold of the process that is upon the lower lid, and dissect it off as far as the body; he should then do the same with the process on the upper lid, after which he must lay firm hold of its body, with its processes attached to it, with a pair of forceps, and dissect it out. The only instruments necessary are a pair of forceps, and a scalpel or sharp pointed bistoury; some recommend that while it is dissecting out it should be held by a ligature, passed through its body, instead of forceps. During the operation great caution must be observed not to wound the puncta or lachrymal canals, and not to cut away the whole of the caruncula. The after treatment consists in keeping the eye bathed with a little milk and tepid water, and if a fungous growth makes its appearance, it should be kept down by the application of the nitrate of silver.*

* I take the following statement, made by Mr. Wilde, from the Dublin Quarterly Journal of Medical Science. *Follicular Tumour of the Caruncula.*—The accompanying illustration affords a tolerably correct idea

Inflammation of the Semi-lunar Membrane and Caruncula Lachrymalis.—Cold or injuries may produce inflammation of these parts; when such is the case they become enlarged and of a bright red color. Considerable pain is suffered when the lids are moved, the tears are obstructed and there is an increased secretion of mucus. The inflammation sometimes terminates in suppuration of the caruncula, which is apt to be followed by a fungous excrescence, which must be touched with the nitrate of silver, and if it does not yield, to this, it must be snipped off with a pair of scissors.

of this rare form of disease, which closely resembles benign encanthis. It occurred in a girl aged eighteen years; when this drawing was taken, about two years ago.

An oblong, fleshy mass, occupied the internal angle of the right eye, projected over the commissure, and lay between it and the nose. Upon close examination it was found to be minutely lobulated on its surface; it was not very sensitive to the touch; and on raising it up and drawing it forward, it was found to be attached both to the lower edge of the caruncula and the conjunctival lining of the inferior lid; but that it was not a mere enlargement of the caruncula itself was manifest, from a portion of the body being distinguishable behind and above it: the second root was situated between the punctum and the extremity of the inner angle of the lids. The tumour was polished on its surface, and totally devoid of hair. The patient stated that the disease had existed for many years, but, except the deformity, gave her very little inconvenience till latterly. It used occasionally to bleed when rubbed, and she says it generally increased in size and depth of color during the menstrual period. A fine ligature was passed over the tumor, and tightened as far down towards its root as possible, when the tumor assumed a purple color instead of the bright florid red which it previously exhibited. After a few hours the tumour was removed with a pair of scissors, at the line of strangulation, and scarcely any hemorrhage ensued. Upon examination the tumour was found to be chiefly composed of conical eminences, formed of capillary blood-vessels, held together by loose cellular tissue, and covered by an unusually thick layer of epithelium. The resemblance which it presented to the microscopic appearance of condyloma was very remarkable. In the course of a twelve month it grew again, and was lat ly removed."

CHAPTER XVII.

INJURIES OF THE EYE-BALL.

Injuries of the Cornea—Although the conjunctiva may be injured without lesion of the cornea, yet the cornea cannot be wounded without lesion of the conjunctiva. Chips of steel, iron, stone, glass, wood, &c., are sometimes driven with such force against the cornea as not only to wound the conjunctiva covering it, but to pierce the cornea itself, and very often become imbedded in its substance, although sometimes the body will fly off after wounding it. Whilst these bodies are imbedded in the cornea they produce inflammation, lachrymation, and blepharospasmus, which symptoms generally disappear as soon as the body is removed, with the exception of the inflammation, and although this is sometimes very slight and soon disappears, yet it very often appears in a very severe form, even giving rise to infiltration of matter between the layers of the cornea, producing what is termed *onyx*; and it is by no means unusual for the inflammation to spread to the iris, and this, if allowed to go on unabated, either through neglect or improper treatment, is followed by an hypopium, and in all probability will terminate in the total destruction of the eye. If a foreign body be imbedded between the layers of the cornea, and not removed by art, the part to which it is attached may slough and the foreign body be cast off by the process of ulceration; after which, when the ulcer heals, a cicatrix is left on the cornea, to which the term *leucoma* is given. Sometimes a layer of new substance is formed over the foreign body, when it will remain in the cornea for life, without producing any bad effect except leaving an incurable spot on it. This generally results from gunpowder explosions.

Treatment.—All foreign bodies lodged in the cornea should be at once removed, and to accomplish this it is sometimes necessary to cut down upon the body; but as a general rule the remarks made on removing foreign bodies from the conjunctiva are equally applicable here. The only after treatment I find necessary in ordinary cases is to give the patient a smart saline purge, order strict quietness and low diet for a few days, and direct that the eye be bathed with a little milk and water. I sometimes, however, find it imperative to bleed from the arm, and if the inflammation continue unabated, to give calomel and minute doses of tartarised antimony. I have such cases nearly every day, and I generally find that when the patient comes at once after the injury, and does not let ignorant persons interfere with him, the inflammation subsiding when the foreign body is removed. But I regret to say that I often find the eye receiving more injury from the attempts made by ignorant persons to remove the body than it does from the body itself.*

Penetrating Wounds of the Cornea.—Wounds of the cornea sometimes penetrate into the anterior chamber of the eye: the result depends upon the part of the cornea wounded, the extent of the wound, and the description, whether incised, lacerated, or punctured. All wounds of the cornea, after they heal, must leave a cicatrix of greater or less extent, but some of them are so very small as not to be visible to the naked eye; for example the punctured wound caused by the cataract needle, or the incised wound made by the extracting knife. A lacerated wound, inflaming and suppurating, will leave such an opaque cicatrix as to interfere with vision in a greater or less degree, according to its situation and extent. There are few

* In the Medical Gazette for June 4, 1847, there is a case reported, of tetanus terminating in death, the result of a lacerated wound of the cornea from the lash of a gig whip. The patient was a man aged 33 years.

penetrating wounds of the cornea, except very small and oblique punctured ones, that as soon as the bodies which cause them are removed, are not followed by the loss of the aqueous humour, which very frequently causes a protrusion of the iris. The loss of the aqueous humour is of but little consequence, as it is soon renewed when the wound heals; but the protrusion of the iris is quite a different thing, for restoring and keeping it in its proper position is not such a very easy matter.

Treatment.—Where there is an incised or lacerated wound of the cornea, and no prolapsus of the iris, the treatment consists in removing any foreign body, if such exist, then in bringing the edges of the wound together, and keeping them so by closing the lids, over which a few strips of plaster should be applied to keep them fixed; indeed, as a security against their stirring, both eyes should be covered with a bandage for a few days. The eye should be examined on the third day, when, if all has gone on well, it will be found that the wound is healed, the aqueous humour reproduced, and no evil has resulted from the injury. If, however, inflammation is present it must be removed by the usual means. If the wound is followed by a prolapsus of the iris, it is necessary first to restore the iris to its natural position; the wound is then to be treated as already mentioned. Some authors declare that no attempt should be made at reducing the prolapsed iris, if the accident has occurred longer than one or two hours,—others say after as many days; I think both are extremes; I should be sorry to consider it hopeless after two hours, although I should consider it perfectly so after two days, for before that time adhesive inflammation must have set in, which causes the prolapsed portion of iris to be adherent to the edges of the aperture in the cornea.

The best method of restoring the prolapsed iris is to make gentle pressure on it, with the fingers, through the

eye-lid, which should be rubbed over it, after which, if it be the external edge that is prolapsed, the eye should be suddenly exposed to a strong glare of light, which causing the pupil to contract will thereby draw in the prolapsed portion of iris; but if it be the pupillary edge that is prolapsed the eye should not be exposed to the light, but the iris should be got as quickly as possible under the influence of belladonna. When all these modes of treatment fail it is recommended to try and restore the prolapsed portion of iris by raising the edge of the wound with a blunt probe; this treatment will sometimes succeed, but very frequently it only causes more of the iris to prolapse.

Should all attempts to reduce the prolapsed iris fail, it must be snipped off with the scissors, or touched with the nitrate of silver every day, or every second day, till it is brought on a level with the cornea. Before the surgeon uses the scissors he must be sure that adhesive inflammation has taken place, for if it have not he will only favor the prolapse of another portion of the iris, or the iris may be suddenly restored to its natural position, having in it a false and true pupil. When a punctured wound of the cornea, made with a small body, does not heal, but allows the aqueous humour to drain off, it should be touched with the pure nitrate of silver every one or two days. And the readiest and safest way of doing this is by moistening the point of a small brush, then touching with it a piece of the nitrate of silver; after which the point of the brush is to be immediately applied to the affected part.

The two following cases will be found interesting:—September 10th, 1846, I was consulted by Mr. B. for (as he said) a speck on his eye, which prevented his seeing clearly, as it was in the axis of vision. He stated that six months previously he was struck with a rope on the eye which left something sticking in it, but that immediately after the accident, Dr. ——— removed the particle with the point of

his lancet. On examining his eye with a good light, and the assistance of a lens, I could clearly distinguish that there was something like a thorn which had pierced the cornea. I removed it with the point of a cataract needle and found that it was a thistle thorn. The punctured wound in the cornea healed up in about forty-eight hours after, without any treatment but touching it once with the nitrate of silver.

July 28th, 1847, Patrick Wheeler, aged 38, labourer, presented himself at the Eye Institution, having his eye bound up with a handkerchief. He said he had been breaking stones at a place some miles distant from the city, and that a chip of stone struck his eye about one hour previously. On examination I found the lower half of the cornea raised in a flap, all the aqueous humour gone, but no protrusion of the iris. I placed the edges of the wound together, closed the lids, and kept them so by means of strips of adhesive plaster and a compress and bandage,—all of which I removed on the third day following, when I found the wound healed. The little inflammation that remained disappeared in a few days, leaving the eye perfectly well.*

Foreign Bodies in the Aqueous Humour.—These bodies sometimes pass through the cornea into the chambers of the eye, after which the wound in the cornea may or may not heal up. After passing through the cornea they may lodge

* In the Dublin Quarterly Journal of Medical Science, No. 10, page 501, the following statement is made by Mr. Wilde, and I regret to say that from my experience I cannot agree with him in his views of belladonna, when the portion of iris protruded is at its ciliary edge, nor have I as yet tried the remedy proposed by M. Desmarres. "If the protrusion is recent, it may frequently be reduced by the application of belladonna and atropine, and lessening excessive action locally; at the same time carefully avoiding all mechanical attempts at reduction. We usually cover up the eye for forty-eight hours after the accident, applying the belladonna as frequently as possible. With the rule laid down in books, of not applying the belladonna if the rupture has occurred near the edge of the cornea, we cannot agree, for if the iris dilates generally, it must of necessity tend to draw the small protruded portion within the chamber. If the iris has become adherent, all such attempts are fruitless; we must then direct our efforts to the removal of the hernia. Unless the patient is very steady, and will allow

in the anterior or posterior chambers, or adhere either to the iris or the capsule of the lens. No matter how small the body, if it wound the capsule of the lens it will produce cataract, and if in the iris, iritis, unless the body is very small; when in the chambers, if large, it will produce inflammation, but if very small and the body be a metallic substance, it will become oxidised and dissolved.

Treatment.—If the foreign body is very small, such as a grain of gun-powder or a spark of steel, and is lodged in either the iris or the aqueous humour, provided it produce no pain or inflammation, it may remain there undisturbed: but no matter how small the body, if it come in contact with the capsule of the lens, it must be at once removed, in which operation great care must be taken not to wound the part in so doing. To remove one of these bodies it will be found necessary to open the cornea with a cataract knife, in the same way as if about to perform the operation of extraction. The wound in the cornea should be made large, so that the body may be the easier extracted; some of the humour also should be allowed to escape before the knife is withdrawn, for if the opening be but small, and none of the humour be allowed to escape, a prolapsus of the iris is more likely to ensue. It sometimes happens that when the wound is made in the cornea the foreign body

the operation to be performed quietly, and permit oil to be applied to the protrusion immediately afterwards, the use of the solid nitrate of silver is often injurious. Evacuating the fluid of the little sac with a fine needle can only be performed under like circumstances, as all rough-handling, or forcible opening of the eyes, is injurious, and at times increases the mischief. When no progress has been made for more than the ordinary time, we have snipped off the protrusion with a curved, blunt-pointed scissors, and thus got rid of the cause of irritation. M. Desmarres has lately recommended a new method for reducing iridial hernia, by cauterising a spot upon the sclerotic conjunctiva, close to the corneal aperture, with solid nitrate of silver, the pupil having been previously placed under the influence of belladonna. By this means, he says, a very active inflammation of the vessels which feed the edges of the ulcer is induced, and by an increased secretion round the margin of the hernia it is set free, and drawn within the chamber. If one effort fails, he repeats the caustic several times. We have no experience of the practice, but intend to give it a fair trial."

escapes with the aqueous humour, however, such a favorable occurrence is by no means usual, the surgeon having generally to remove it with either a small hook, forceps, or scoop. And here I would remark that I know of no operation on the eye that requires greater caution and skill than the removal of some of these bodies.

The after treatment consists in bringing the edges of the wound together, then closing the lids and keeping them so by covering them with a compress and bandage, or a few strips of adhesive plaster. It will be also necessary that the sound eye should be hood-winked; quietness should be particularly observed. If inflammation sets in it must be treated on general principles.*

Injuries of the Iris.—It has been already stated that the iris is often injured by bodies that penetrate the cornea: but there are other ways whereby it may also be injured; for example, a blow on the eye may displace the iris, separating its ciliary edge from the ciliary ligament, or its pupillary edge may be lacerated. When the former accident occurs the natural pupil generally closes, the artificial one remaining open, but it sometimes happens that both pupils will remain open. When it is the pupillary edge that is lacerated, the pupil generally dilates till it forms a perfect ring, so that even its edge cannot be seen; this will of course lay the foundation of amaurosis.

Treatment.—The only treatment that can be pursued in such cases, is to guard against inflammation,—the iris can never be restored to its natural position.

Injuries of the Crystalline Lens and Capsule.—Wounds of the capsule or lens, are generally followed by traumatic cataract. All authors agree that although the aqueous

* In the Dublin Quarterly Journal of Medical Science for August 1848, there is a case recorded by James Dixon, F. R. C. S. E., surgeon to the London Ophthalmic hospital, of a foreign body, which was a piece of percussion cap, being expelled from the eye after remaining in the anterior chamber for eight years.

humours will dissolve an opaque lens when it comes in contact with it, yet it will render a healthy lens opaque when placed in the same position. But how the lens is thus rendered opaque no one that I am aware of has ever attempted to explain. My impression is that the lens becomes opaque from the effects of inflammation; whether such is produced by the lens coming in contact with the aqueous humour, or is caused by the wound, is of but very little consequence, but that it is the result of inflammation is evident, from the following facts:—1st. That it often spreads to the iris, producing adhesion between it and the capsule of the lens; And 2nd. That well directed treatment, in proper time, will allay the inflammation, prevent the formation of a cataract, the wound leaving no evil result but an opaque cicatrix on the capsule of the lens, and even much of this opacity is removed in time by the action of the absorbents.

Treatment.—The general treatment must be antiphlogistic, such as purging, nauseating doses of tartarised antimony, &c.; but I do not see much use in bleeding; great quietness of both eyes and body is requisite; and it may be even sometimes necessary to give mercury till the system is gently affected. The local treatment consists in keeping the eye-brow and lids smeared with belladonna, and a cloth wetted with either cold or warm water laid on the eye, as the patient finds most comfortable.

Dislocation of the Lens.—A blow on the eye may dislocate the lens by forcing it through its capsule. When such an accident occurs the most general place for the lens to lodge in, is either the anterior or posterior chamber of the eye; It may be forced backwards into the vitreous humour, or may burst through the choroid and sclerotic coats, and become fixed under the conjunctiva.

Treatment.—If the lens, lying in the anterior or posterior chamber of the eye, press upon either the cornea or iris, and thus produce inflammation, it must be removed by extrac-

tion through the cornea, but if it produce no inflammation, it may be left to the absorbents to remove. When it is situated under the conjunctiva, it should at once be removed, as there is no danger in the operation, and all that is required is to make a section of the conjunctiva down upon it and it will slip out. The after treatment will be to keep the eye closed for about twenty-four hours. When it is thrown back into the vitreous humour, it becomes a question whether it should be extracted or not, for the vitreous humour being broken up, it is very difficult to prevent its escaping when the attempt is being made to extract the lens. So long as it did not produce inflammation, I would let it remain quiet, and even if there should be slight inflammation I would try other means, which would consist in depressing the lens with the needle, keeping the pupil dilated with belladonna, and using general antiphlogistic measures. It must be remembered, however, that sometimes the inflammation will run to such a height that the lens must be extracted at any risk.*

Wounds of the Sclerotic and Choroidea.—In Chapter XV, under the head of “Lacerated Wounds of the Eye-lids,” I gave a case where not only the lids were wounded, but also the sclerotic and choroid coats of the eye. The treatment of the case is also given.

Wounds of the sclerotic and choroid are not so dangerous as some authors would lead us to suppose, for, if such were the case, operation for cataract, which is so often performed

* November 8th, 1849, Patrick Ryan, aged 14, shoemaker, apprentice presented himself at the Montreal Eye and Ear Institution, when he stated that for ten days he had been blind of his left eye, caused by a blow of his own hand, which slipped when in the act of drawing a last from a shoe. On examination, I found that the lens had been dislocated, and was now fixed in the pupil, one part of it being in the anterior, the other in the posterior chamber of the eye. Iritis was present. The treatment I adopted was successful, which was taking hold of the lens, on the point of the curved cataract needle, and depressing it down into the vitreous humour. The iritis soon after disappeared under the use of the ioduretted iodide of potassium. The boy's eye is now perfectly well, and his sight restored.

through these coats, would be more frequently attended with evil results. The dangerous consequences from wounds of these parts, depend more upon the extent of the wound than anything else, and when extensive, the great danger is, that the vitreous humour will escape, which would cause the eyeball to shrink up, and sight would be lost for ever.

Treatment.—Any parts that are protruded through the wound must be restored to their natural position by gently pressing and rubbing the lids over them; the eye-lids must then be kept closed with strips of adhesive plaster and a compress and bandage, which may be removed after thirty-six or forty-eight hours; quietness and general antiphlogistic treatment are always necessary in such cases. If the foreign body which causes the wound, be lodged in the eye, and is at the same time small and not easily extracted, I would not recommend that any great effort be made in searching for it, but simply to guard against inflammation; for if the body is lodged in the vitreous humour, I think it probable that more injury would arise from searching for it than could result from its being left there; of course if it produce very great inflammation it must be removed.

Mr. Mackenzie recommends that it should be extracted, if that it be sunk in the vitreous humour, but adds that he has seen several cases where such foreign bodies have been left within the eye, the wound cicatrizing and remaining closed for months, after which it again opened, and the foreign body, coming into view, was extracted. There is no doubt that if at any time the foreign body comes thus into view it should be extracted, which is very different from searching for it in the vitreous humour.

It may be here remarked that gun-shot wounds of these parts differ in no respect from wounds caused by other foreign bodies, except so far as respects the force with which the body is propelled, and the extent of the wound; also, if the powder strike the eye, it leaves a stain, if not speedily removed.

Blows on the Eye not producing an External Wound.—A blow on the eye-ball often produces sudden amaurosis, without deforming the eye in the slightest degree, or even producing an appearance of inflammation. The probability is that in such cases there is concussion or laceration of the retina. The treatment should be antiphlogistic, and the patient got as quickly as possible under the influence of mercury. The ciliary vessels are sometimes ruptured by a blow on the eye, causing the chambers, and sometimes even the cells of the vitreous humour, to become suddenly filled with blood. When such an accident occurs it generally ends in loss of vision, for very frequently, after the blood is absorbed, the retina is found insensible. If, however, there is only blood in the chambers, it will be absorbed and vision restored, but if it get into the cells of the vitreous humour the case is hopeless. June 28th, 1849, I had a case of rupture of the ciliary vessels, which filled the chambers of the eye with blood; it was absorbed in a few days. The injury was caused by a cork from a soda-water bottle striking the eye-ball.

A smart blow on the eye, such as is given by the lash of a whip, will often cause blood to be effused between the layers of the cornea, but it is soon absorbed by antiphlogistic treatment and cold applications to the eye. Blows on the eye, as I have already shown, may produce a dislocation of the lens, or they may rupture the iris.

CHAPTER XVIII.

OPHTHALMIA.

By the term ophthalmia is meant inflammation of any part of the eye, but more particularly when the conjunctiva is the part affected. There is no term more likely to set the student or young practitioner astray, than that of ophthalmia being applied to every inflammation of the eye, without any distinction as to the part inflamed. I shall endeavor, in as simple a manner as possible, to show what are the diseases to which the term is applicable, avoiding all such divisions and sub-divisions as do not lead to any practical result, and carefully adhering to those that do. And here I think it well to remark, that although any one particular part of the eye may become the seat of inflammation, and that of a particular kind, yet when speaking of inflammation of a part, it is not meant that the inflammation is confined to that part, but that it originated there; for inflammation cannot continue any great length of time in any part of the eye without spreading to other parts, not at first affected. The phenomena of inflammation in a part are heat, redness, pain, and swelling. As a general rule these signs are to be found in inflammation of the eye, but other symptoms are to be found accompanying them according to the texture inflamed; and in some instances some of these symptoms will not be seen, while in other cases none of them will be observable; hence, the great necessity of describing the inflammation of each part separately. Inflammation of the eye may be either *specific* or *idiopathic*; and these may be modified by a peculiarity of constitution. Another distinction to be particularly attended to in inflammation of the eye is its division into chronic and acute; for

the means which would subdue the former would produce no good effect on the latter.

The practitioner must never lose sight of the important difference between inflammation and its consequences. He must also bear in mind that inflammation may be, from the very beginning, of a chronic form, and never partake of the acute unless such a state is produced by the erroneous interference of those who do not understand the exact phases of the malady.

General Causes of Inflammation of the Eye.—Among the general causes of inflammation of the eye are injuries of every kind, both mechanical and chemical. Either very warm or very cold air will act as an exciting cause. Beer was of opinion that the quantity of electricity in the atmosphere had much to do in affecting the eye. Among the indirect causes he enumerates immoderate bodily exercise, violent emotions of the mind, injudicious clothing, and high living. He also considered contagion a more frequent direct cause than infection.

It is strange that light, which is indispensable to the functions of the eye, should be a cause of inflammation; nevertheless, such is the case both as respects its quantity and its quality, but more particularly the latter. All strong artificial lights, or reflected light from red or polished surfaces, are well known to act as an exciting cause of ophthalmia, but it is in a greater or less degree according to the irritability of the eye. Beer considered the direction of the rays to make a great difference, conceiving that the eye was less capable of bearing them with impunity the more they receded from the perpendicular line, and struck the organ slopingly or horizontally. When we consider the position of the eye-brows and eye-lashes, acting, as they do, as a shade to prevent horizontal rays from striking the eye, it must be acknowledged that there is some reason in this theory of Beer's. But he further observes that every state-

ment concerning light should be only received in a relative sense, for the degree of light which would answer very well for the eye of an African would destroy the eyes of many Europeans, and the same light which is borne without any inconvenience by the eye of an adult would excite in the eye of a new born infant *ophthalmia neonatorum*. Why light should produce inflammation in any of the coats of the eye, or how it produces it, I have never found explained by any author, nor do I wonder at it when I consider the views taken on the physiology of the eye. Were the retina only the primary seat of the inflammation, it would admit of an explanation; but when we find that the conjunctiva is the part that is generally attacked, we are at a loss to explain how it occurs. I consider that it can be explained in one way only, which is, by granting that the ophthalmic branch of the fifth pair of nerves is sensible to the stimulus of light, and that under particular circumstances, light of a peculiar kind acting on this nerve, produces a morbid irritability of it, and thus acts as an exciting cause of inflammation. (See the Physiology of the ophthalmic branch of the fifth pair of nerves, in Chapter III.

There are many other indirect causes of inflammation of the eye, such as the free use of ardent spirits, exanthematous fevers, suppression of the natural discharges, &c. All these causes will be more particularly considered when treating of the peculiar kind of inflammation which they produce.

To give any general treatment for inflammation of the eye, I have only to state that it is the same, varying according to circumstances, as that which has been mentioned by every writer on surgery for inflammation in any other part of the body, such as bleeding, purging, nauseants, diuretics, opiates, diaphoretics, mercury, rest, low diet, &c.

Catarrhal Ophthalmia, or Mild Inflammation of the Conjunctiva.—This disease is purely specific, and differs in

every respect from all other forms of inflammation of the conjunctiva. It is distinguished from purulent ophthalmia by the comparative mildness of its symptoms; the discharge being much less copious, the pain not so severe, and although the vascularity may be very great, yet it never runs into perfect chemosis, or induces sloughing of the cornea. In Europe it is found to prevail more in the spring and fall than at any other time of the year; but in Canada I find it occur oftener during the winter, particularly when thaws prevail, such as what is termed the January thaw—which comes on suddenly, and in the severe winters of this country, produces a very great transition, the thermometer rising, sometimes in the course of a few hours, from several degrees below zero, to temperate or even higher.

Symptoms.—The first symptom is an itching of the eye, followed, in a short time, by an unpleasant sensation, as though an eye-lash or mote had got between the eye-lid and the eye-ball; which sensation is caused by the rubbing of the eye-lid over the enlarged vessels of the conjunctiva. With this vascularity of the conjunctiva there is a copious flow of tears, and both symptoms are much increased by the patient rubbing the eye with his hand. The second morning after these symptoms, the eye-lids will be found adhering together, from the increased mucous secretion of the conjunctiva, and the secretion from the meibomian follicles collecting on the edges of the lids, and becoming dry and encrusted from exposure to the air. If at this stage of the disease the eye be examined, the palpebral conjunctiva will be found to have acquired an uniform deep red appearance, and the sclerotic conjunctiva will be seen to be an equal vascular net work, but the vessels not crowded together so as to produce a general redness as in severe ophthalmia. Chemosed spots may sometimes occur in the vascular net work, but true chemosis never exists, for when what might be called chemosis does exist, it is no

longer the disease here treated of, but severe inflammation of the conjunctiva. At the commencement of the disease the secretion from the conjunctiva is transparent, but it soon becomes opaque, thick, and puriform, and during the day time is not so visible, being removed, as fast as it is formed, by the great flow of tears; but if the patient remain quiet, with his lids closed for a short time, then, on depressing the lower lid, flakes of matter will be seen floating in the tears. As the disease advances all these symptoms increase in severity. Exacerbations generally take place in the evening, which, however, are generally followed, and the patient relieved, by a good night's rest. During the prevalence of the above symptoms vision is not much impaired, but there is an occasional haziness of sight, caused by the tenacious fibres of purulent matter adhering to the cornea. If the patient be a healthy subject, and the case goes on well, on about the third day the sensation of a foreign body in the eye, and the great flow of tears becomes less frequent, the vascularity not so intense; but the discharge is more freely secreted. Subsequently, all the symptoms gradually diminish and finally disappear, leaving the parts something more vascular than before the attack, but this vascularity disappears in a couple of weeks, leaving the eye perfectly well. Unfortunately the cases met with in every day practice are not such as has been just described, as the inflammation is generally modified either by a scrofulous constitution, improper treatment, neglect, deficient food or clothing, and what is very general, a want of cleanliness.

Both sexes and all classes are liable to this disease; neither does age seem to make much difference, although Dr. Jacob says he has found it affect young persons more frequently than adults, and Mr. Mackenzie says it is the most common disease of the eye, in adults. In my experience I have found it in its true simple form more frequent in adults,

and in its modified form in children, when it generally degenerates into phlyctenular ophthalmia. If it be modified in the adult it very frequently becomes complicated with pustular conjunctivitis.

Causes.—The chief exciting causes of this disease are exposure to cold and wet, particularly if the patient has been previously heated, and has at any preceding time suffered with the disease. Impure air is another very general cause, which is proved by the fact of the disease attacking those who are crowded together in schools, ships, hospitals, barracks, &c.

Dr. Jacob says it is epidemic or endemic, and whether contagious or not, will attack several individuals in the same family. I do believe that if the puriform discharge is conveyed from the eyes of the patient to any other person's eye, it will produce the disease in the second person; and Mr. Mackenzie gives it as his opinion that where the disease is thus produced it is more severe, more distinctly puriform, and more dangerous in its effects to the cornea, than in the first case.

Prognosis.—In the simple form the prognosis may be always favorable; but if, through neglect or improper treatment, the nature of the disease is changed, so as to produce febrile excitement and constitutional illness, as well as local distress, then there is danger to the eye. If the inflammation is modified by scrofula the prognosis cannot be so favorable.

Treatment.—There are different opinions as to the best treatment of this disease, some recommending one chiefly of a local stimulating nature, others preferring a partially antiphlogistic. Among those who support the former is Mr. Mackenzie, whilst Dr. Jacob favors the latter mode, but he says, with reference to the stimulating treatment: "It is not to be denied that such applications may have the effect of arresting the progress of the disease at once;

but if they have not that effect they are liable to produce an increase of irritation." I fully agree with Dr. Jacob, that, if the progress of the disease is not arrested, an increase of irritation will follow; but such an occurrence can only result from the application of improper stimulants. I know of none that can be used with safety except a strong solution of the nitrate of silver, the strength of the solution depending upon the violence of the disease; I rarely find it necessary to use it stronger than ten grains to the ounce, I sometimes, however, use it of double that strength. In a case of this kind, my practice is to clean the eye with a sponge and a little warm water, then drop on the conjunctiva the ten grain solution and allow it to remain there, keeping the lower lid depressed, for about one minute, then wipe it off; this I repeat every morning so long as the inflammation is severe, but as it abates I use the solution weaker till I come down to the four grain solution. During the continuance of the disease I desire the patient to drop upon the inflamed eye every night the four grain solution, and to smear the edges of the eye-lids with a small quantity of the red ointment, to prevent them from adhering together during the night; I also give him a vial of the following lotion to bathe his eyes with on rising in the morning, and twice or thrice afterwards in the course of the day. It should always be used tepid, and allowed to run over the eye, which should afterwards be made perfectly dry with a fine warm cloth. The lotion is one recommended by Mr. Mackenzie, and is made as follows:—

℞ oxmur. hydr. gr. i
 Sal ammoniac, gr. vi
 Vinum opii, ℥i
 Aqua pur ℥viii M ft lotion.

Mr. Mackenzie calls this his soothing lotion. Cleanliness being of the greatest importance, I always give particular directions to have the purulent matter constantly

wiped away, (and never allowed to get dry), with a sponge and warm water.

If there is much constitutional disturbance, I give the patient an emetic and purgative, or a purgative only, and afterwards a diaphoretic mixture to be taken occasionally, such as the liquor ammoniæ acetatis, with minute doses of tartarised antimony. I have never found it necessary to use a lancet, indeed I do not see what benefit could be derived from blood-letting when the inflammation is in a mucous membrane. As to leeching or scarifying the eye-lids, I have no confidence in either mode of taking blood, for if blood is to be taken at all it had better be taken generally. Blistering in the acute stage I have always found worse than useless; but when the inflammation is chronic, benefit is sometimes derived from blistering the nape of the neck. I always order the patient to live low, and keep quiet for a few days, but not longer. I have always found that starving a patient and confining him to a dark room aggravates the disease, while gentle exercise and fresh air has a more beneficial effect than any treatment I could adopt. If the light should cause pain I direct the patient to wear a green shade over the eyes.

Severe Inflammation of the Conjunctiva.—This disease presents itself in three different forms, not specifically distinct as to symptoms, but distinguished from each other by origin, history, progress, and consequences. They are termed the *purulent* or *Egyptian*, the *gonorrhœal*, and the *purulent ophthalmia of infants*, which is also called *ophthalmia neonotorum*. These different forms of this disease will be considered in regular order.

Purulent or Egyptian Ophthalmia.—The purulent ophthalmia acquired the name of Egyptian, from the fact that the attention of the profession was particularly called to the disease, upon the return of the British troops to Europe from Egypt, where this disease spread among them with

such uncontrollable violence and destructive consequences. As all who have written on this disease, have given one and the same history concerning the sufferings of the British troops, and the opinion of Dr. Vetch and others concerning the disease, I do not see any occasion for going over the same details, but will come at once to the description of the disease, particularly as it is now an acknowledged fact that severe purulent ophthalmia and the Egyptian, are one and the same disease.

Symptoms.—The symptoms of this disease follow each other in such rapid succession that it is nearly impossible to observe them in the order in which they occur; and consequently it is very rare for the surgeon to see a case from its commencement to its termination, so as to follow it through its various stages. The first symptoms are similar to those which are found in simple inflammation of the conjunctiva, but they are much more violent, the itching and sandy pain being much more severe. Whether the inflammation is produced by the application of virus or otherwise, the first appearance of inflammation is to be observed in the lining membrane of the lower eye-lid, which presents a mottled appearance and then assumes a fleshy redness. Even in the early stage of the disease a little mucus is sometimes found on the reflected portion of the conjunctiva, but it does not generally appear till the purely inflammatory stage is past, which usually lasts from twenty-four to thirty-six hours. It sometimes occurs, though very rarely, that the patient is first made aware of his eyes being affected, by finding the lids to be adhered together, with the encrusted purulent discharge, on awaking in the morning.

When the inflammation has extended to the whole palpebral conjunctiva the purulent secretion is much augmented, and becomes more distinctly puriform, getting thick and yellow, and sometimes so abundant as to flow down over the patient's cheek every time he opens his eyes. This

portion of the conjunctiva, particularly that of the upper eye-lid, becomes swollen as the discharge increases, which state is caused by serous effusion taking place immediately under the membrane, with the inflammatory development of its papillary structure: although the inflammation sometimes spreads so rapidly from the palpebral to the sclerotic conjunctiva, as to prevent any distinct observation of its progress, yet it will very often remain in the palpebral, before spreading to the sclerotic conjunctiva, for twelve or twenty hours, and even in some instances will not spread to the sclerotic conjunctiva but remain in the palpebral, and after weeks or even months the purulent secretion becomes gradually diminished, and recovery finally takes place. But when the sclerotic conjunctiva does become inflamed, every part of it, even up to the edge of the cornea, becomes so injected with blood, so as to leave no space unoccupied. Thus is this disease, in its first stage, characterised by the great and uniform redness of the eye, without any of that pain, tension, or intolerance of light, which accompanies most other forms of inflammation of that organ, the only pain being that of a sandy feeling between the eye-lids and eye-ball. (The cause of this feeling has been explained in the previous article on simple inflammation of the conjunctiva). The second stage may be considered to have commenced when serous effusion into the sub-conjunctival cellular tissue begins, which elevates the conjunctiva, forming a chemosis, soft, and of a pale red color. This effusion generally commences in the lids, and gradually extends over the eye till it comes to the edge of the cornea, where it ceases to disturb the conjunctiva; the chemosis, however, continues to enlarge till it overlaps, and buries, the cornea; it then protrudes between the lids, and causes them to become slightly inverted. How this eversion takes place has been well explained by Dr. Vetch in the following words:—"The inversion of

the cilia may be explained, by comparing the palpebra to a sail bent to a rope, the more the sail is distended, the cord is drawn upwards and inwards."

During the formation of the chemosis, œdema is going on beneath the integuments of the palpebra, so that both these combined, form a tumor of great magnitude; and the swelling is yet more increased by a great quantity of the purulent matter, not escaping over the cheek, but remaining pent up between the lids and eye-ball.

When the eye is in this state, it is impossible for the surgeon to examine it, although he may be sure, from the attacks of excruciating pain, that mischief is going on. When the disease is thus far advanced the most favorable termination that can be expected is, a gradual subsiding of the symptoms, till, at the end of four or five weeks, they altogether disappear, leaving the palpebral conjunctiva in a rough or granulated state, which is caused by the papillæ of the conjunctiva becoming hypertrophied. Should the disease continue to increase, occasional sharp piercing pain will be felt in the eye, accompanied by throbbing and fulness of the temples; then follows excruciating deep seated pain in the eye, it being seldom in both eyes at the same time, but shifting rapidly from one to the other. It generally comes on in paroxysms which are aggravated during the night, but decline towards the morning. This pain will sometimes abate in two hours, at other times not for five or six, and in some instances it will continue without any abatement in its violence until the cornea bursts, which is always followed by a gush of scalding water from the eye, and immediate relief from pain, but unfortunately the symptoms will increase in violence in the other eye. If the disease continues unabated, rupture of the cornea will occur sooner or later, whether the pain be continuous or in paroxysms. This great suffering is increased by pain in the back of the head

which is sometimes so violent as to surpass that in the eye ; the patient will always state that it is confined to a spot which he can cover with the point of his finger or thumb.

“The first sensation of rupture,” (says Dr. Jacob,) “is when the disease is left to improper treatment, often followed by a second and a third, till exhausted by its own violence, the attacks become shorter and less severe, not, however, till after the lapse of many weeks, and even months, do they altogether cease.”

The disease is generally at the height of its violence when the cornea ruptures ; but the length of time before this takes place varies in different cases, for in some it happens after a few attacks of pain, while in others the paroxysms may occur daily for weeks before it takes place. There is one remarkable fact attending it, which is, that during these paroxysms the purulent discharge is diminished, although the tears are much more copious. After the cornea is ruptured the disease generally begins to abate, the œdema and chemosis subsiding, and the lids, which during the chemosis were inverted, finally becoming everted. This slight eversion is increased by the granulated state of the palpebral conjunctiva.

The following quotation from Mr. Mackenzie's work is worthy of attention :—“For the most part the attacks of the pain are sudden ; occasionally they are preceded by chilliness and slight nausea, or by a peculiar sensation about the head. Frequently the pain occurs with a remarkable increase of heat around the orbit, in a degree no less excruciating than in the eye itself. The space over the frontal sinus, the temples, and the face, are its frequent seats, or, to speak more correctly, it affects the branches of the fifth nerve distributed to those parts. Sometimes it occurs immediately above the eye, commencing about the supra-orbital foramen. This supra-orbital, or, circumorbital pain, is indicative of the inflammation extending to the

sclerotica, cornea, choroid, and iris. Inflammation of those textures always excites sympathetic pain in the fifth nerve."

There are some cases of this disease where the swelling is not so great, previous to the cornea becoming ruptured, as to prevent an examination of the eye, but such cases are so seldom met with, that for a description of the appearance that the eye would then present, and the manner in which the eye is destroyed, I shall quote the words of Dr. Jacob. Speaking of the practitioner, he says:—"His first consideration should be to recall to his memory the dangerous consequences he is called on to avert, and which constitute the prominent symptoms of the disease. In the first or inflammatory period, he is to recollect that the eye may be lost by sloughing or abscess of the cornea, or by supuration of the whole eye-ball; in the second stage he has to apprehend the injury or destruction of the cornea from ulceration, or that change of organization of the conjunctiva which precedes the permanent increased vascularity, and that peculiar condition denominated granular lids. The nature of the pain experienced by the patient should receive particular attention; if it be the characteristic scalding sensation of sand, beneath the lids, it is indicative of conjunctival inflammation only, but if this be accompanied by intense aching, extending to the temples and sides of the head, it is evidence of extension of inflammation to the eye-ball itself; the cornea and fibrous sclerotic refusing to yield to the distension of inflammatory action, like muscular fasciæ, and the coverings of joints under similar circumstances. As sloughing or abscess of the cornea is the consequence most to be apprehended during the inflammatory period, the practitioner watches with anxiety for any appearance indicative of this evil. It is not perhaps possible to detect the first change which the cornea undergoes in this process, but when the transparent structure assumes a dirty white opaque appearance, either wholly or partially,

the mischief is easily recognized ; and when subsequently the sphacelated portion comes to be cast off by the usual process of ulceration, and exhibits a line of separation between the dead and the living parts, no doubt of the nature of the injury can be entertained. Abscess, in the structure of the cornea, is also liable to occur during the inflammatory period, and has probably been often confounded with the sloughing here described, the distinction being difficult, and the two destructive consequences sometimes being combined, and constituting a condition analagous to common anthrax.

“ Abscess of the cornea is peculiar in this respect, that it does not appear to consist of a distinct sac of purulent matter, but merely a deposit in the cellular or laminated structure of the cornea ; it consequently does not open at one point and discharge its contents, but breaks into an open ulcer, not easily to be distinguished from the broken surface of a slough. The color of the opacity of the cornea constitutes the best criterion ; if the spot be of the usual straw colored tint of purulent matter, and not the dull, dirty white, of dead macerated cornea, abscess, not slough, is the process in progress. Abscess also probably occurs more frequently in circumscribed spots, and seldom extends to the entire circumference of the cornea. The secretion of purulent matter in the chambers of the aqueous humour, is easily distinguished from abscess of the cornea at its commencement, by the purulent matter falling down in the aqueous humour between the iris and the cornea, and by its surface assuming a horizontal level, repeatedly described under the title *hypopyum onyx*, or unguis ; but when the whole chamber is filled with pus, and the cornea consequently presenting a uniform yellow appearance, the real nature of the case is not so obvious.”

The following extract is from an account given by Dr. Vetch :—“ The pain in the second stage arises in part from

the destructive changes which have commenced in the cornea, aggravated by distension of the eye, consequent upon an augmented quantity of the aqueous humour. The formation of that fluid, I have already hinted, may take place through the medium of the ciliary process, and the appearance of the cornea gives no reason to suppose that its internal surface partakes of the inflammation, or that the aqueous humour is increased by any morbid effusion. The distension seems entirely owing to an augmented activity in the secreting vessels; and these certainly are situated in the posterior chamber. Neither does there appear any reason to warrant the idea that the ulceration ever proceeds from within outwards. But the distension of the anterior chamber probably favors the escape of the aqueous humour sooner than it would otherwise happen. The swelling and the purulency prevent us from making any very accurate examination to ascertain the progress of the ulcer. The account I have given of it in a former Chapter is an analysis of what takes place in ophthalmia.

“When any large portion of the cornea sloughs, an adventitious and vascular membrane is often produced, which finally forms a staphyloma. In some few cases I have seen the lens and the capsule exposed without any external covering whatever, and for a short time the patient sees every thing with wonderful accuracy; but as soon as the capsule gives way, the lens and more or less of the vitreous humour escape, the eye shrinks, and the cornea contracts into a small horn-colored speck. This total destruction of the globe of the eye generally ensures the safety of the other, and renders it less liable to be affected by future attacks of inflammation. When one eye is lost by staphyloma, and the other remains useful, it is well to do what nature has left undone, and instead of attempting to reduce the sac by puncturing it, at once to lay it open and extract the lens.”

Mr. Mackenzie says:—"The patient is sometimes able even to see objects pretty distinctly after the cornea has given way, and is apt to believe his eye to be nearly cured, or at least out of danger. The iris is pushed forward into the opening or openings of the cornea, and a dense cicatrix forms over the protruded iris, and partial or total staphyloma is the result. In some cases, the iris remains protruding at different points, scarcely covered, by any cicatrix or pseudo cornea, but presenting a number of dark colored prominences, like the grains of a brambleberry, a state of parts which is styled staphyloma racemosum."

Constitutional Symptoms.—In the early stage of the disease the constitution does not suffer in the slightest degree; the patient can eat, drink and sleep; the pulse is full and soft. But as the local symptoms become severe the constitution begins to suffer, the paroxysms of nocturnal pain preventing all sleep; the pulse becomes sharp and frequent, and if the disease continues, great debility ensues.

Causes.—No person in the present day thinks of doubting the contagious nature of purulent ophthalmia, for it has been well proved that if the smallest portion of the purulent matter is conveyed to a sound eye, it will produce the disease. I could not say *certainly* that it is infectious, as it is doubted by so many, yet the rapidity with which it spreads through schools, ships' crews, and regiments of soldiers, would make it appear to be so; and certainly the surgeon who acts as if it were errs on the safe side. There is no manner of doubt but that any of the causes already enumerated, which produce simple inflammation of the conjunctiva, may also produce purulent ophthalmia; and it is pretty certain, that a case, which is only at first catarrhal ophthalmia, may be by bad treatment converted into severe inflammation, which will terminate in purulent ophthalmia.

This disease is to be found in every climate, but much worse in hot than in moderate, or even cold, climates. And

it is even worse when it occurs in hot and sultry than in moderate or cold weather.

Prognosis.—Even though the eye be saved from sloughing or abscess yet recovery is always both slow and doubtful, in consequence of the great alteration produced in the conjunctiva by the intense inflammatory action.

Treatment.—The local treatment of this formidable disease must be purely astringent ; and the constitutional, as a general rule, antiphlogistic ; but circumstances must guide the surgeon as to the adoption of this treatment ; for example, no man would think of bleeding, purging, &c., a poor half-starved wretch, with a broken constitution, caused by the use of ardent spirits or otherwise ; whereas such means may be used with propriety in a person of a strong, healthy constitution. With reference to the benefit to be derived from bleeding, the following statement is made by Dr. Jacob :—“ Before the practitioner makes up his mind respecting the value of bleeding in this disease, he should pause to consider the effect of this depletion in arresting inflammation of mucous membranes generally ; and having done so, he will probably be prepared to admit, that, in many cases, the lancet is not so valuable a resource as might be expected, or as it is found to be in inflammation of serous membranes, or other structures.

“ The advantage of bleeding in croup cannot be denied, but it is to be recollected, that this disease is more liable to terminate in effusion of coagulable lymph, than in secretion of purulent matter.

“ Catarrhal inflammation of the lining membrane of the nostrils, or the trachea and bronchial tubes, and dysentery in the acute form, are treated by blood-letting, more with the view of diminishing the febrile symptoms than with the hope of cutting short the local inflammatory action. Bleeding will not cure conjunctival inflammation, but it is a most valuable auxiliary means of relief, by reducing the

part to a condition in which other remedies become more effectual. The writer has seen the abstraction of blood carried to the greatest extent possible, consistent with the safety of the patient: he has seen repeated bleedings of forty, fifty and even sixty ounces, and streams flowing from the arm and temporal artery at the same time, without generally beneficial results. More moderate bleedings, suited to the intensity of the symptoms, habit, and constitution of the patient, should, however, form part of the treatment."

After a few remarks as to whether the general bleeding should be from the temporal artery, jugular vein, or the arm; and giving the preference to the last mentioned, he makes the following observations on local bleeding in such cases:—"The local abstraction of blood by leeches or cupping is the next resource, after the effect of the general depletion has been ascertained; it may be resorted to in the evening if the general bleeding took place in the morning, or, according to the urgency of the symptoms, may be postponed till the following day. Twelve, fourteen, or twenty-four leeches, should be applied to the temple, or over the cheek bone, so as to leave an opportunity of stopping the bleeding by pressure, should it become necessary. The irritation, inflammation, and tumefaction, produced by the application of leeches to the swollen eye-lids, more than counterbalances the good, if any, derived from emptying the vessels of the inflamed part.

"The advantage of bleeding by leeches appears to depend upon the continued trickling of blood, which is perhaps best encouraged by the application of compresses of old linen, wrung out of warm water, and removed and replaced every ten minutes, or as often as they become soaked with blood. The application of a few leeches to the conjunctiva of the lower lids has latterly been recommended and practised, and may perhaps be resorted to with safety, and even advantage, in the after stages of the

disease ; but in a case of violent purulent ophthalmia, threatening destruction of the eye, the effect is too inconsiderable to risk any aggravation of the inflammation by the leech bites.

“ Local abstraction of blood from the inflamed conjunctiva by scarification, has been practised from the most remote period ; the same objection may be made to it as is offered to the application of leeches, that is, the small quantity of blood drawn and the great extent of injury inflicted. When the chemosis or vascular tumefaction of the conjunctiva is very great, and the membrane projects between the lids or overlaps the cornea, the writer, in place of merely scarifying or scoring the surface, runs an extracting knife from one end to the other of the tumour, by which the effused serum is allowed to escape, tension is relieved, and generally a considerable quantity of blood discharged. From this practice advantage is frequently derived, without any injurious consequence either temporary or permanent.”

Having given the above valuable quotation I would just state that I have no confidence in bleeding, either local or general, particularly the former, as I conceive it does more harm than good, whatever benefit may be derived from the latter, on Dr. Jacob's principle, viz :—that of preparing the system for a more important treatment. Opening the ecchy-mosed tumour, and thereby allowing the serum to escape, I have always found very beneficial ; indeed, I have very frequently snipped out a good piece of the swollen conjunctiva, and had no cause to regret it.

If the patient be of a good constitution, and accustomed to enjoy the good things of this life, it will be well to begin the treatment with an emetic, which may be followed up by a purgative. Indeed, under any circumstances, it will be necessary to have the bowels kept regular by means of some gentle aperient, during the attack of inflammation. Nauseating doses of ipecacuanha may also be given during

the inflammatory stage, not for its nauseating effects alone, but also for its well known specific action upon mucous membranes. The skin should also be kept moist by means of some gentle diaphoretic, such as the liquor ammoniæ acetatis, but such a class of medicines should not be pushed far. Anodynes are sometimes actually necessary to relieve the patient's sufferings, and in such cases morphine is the best preparation of opium that can be given. In the chronic stage, mercury may be given as an alterative, but I have never seen much benefit from administering it in the acute stage. When the patient is of a broken down constitution, it is sometimes found necessary to give tonics, from the beginning, or from the third or fourth day; but, as a general rule, they should not be given till the chronic stage has set in, when quinine will be found the best tonic. The patient's regimen will depend upon his constitution; if he be a person that requires bleeding and purging, his diet must certainly be purely antiphlogistic; on the contrary, if he require tonics, his diet must be nutritious, although it may be of a light kind, such as broths, &c. Perfect rest of mind and body should be particularly attended to; however, the patient should not be confined to a close dark room, as both light and air are necessary to restore the healthy action of the eye. Should light give pain the eyes may be shaded with a green shade; but it is rather unusual for light to give pain in this disease. If the patient has been long confined to the house, it is astonishing what benefit he will derive from getting out into the pure air; indeed it is wonderful how difficult (in this disease as well as all other inflammations of the eye) it is to cure a patient while confined to an hospital, and this I attribute to the irritation which the eyes must suffer in the ward of an hospital, from the great quantity of ammonia that is given off by the urine that is constantly collecting.

Local Treatment.—There are different opinions respecting the local treatment of this disease; some recommending soothing applications; others stimulating, and there are those that recommend both plans alternately. There is one thing certain, that no matter how good the general treatment may be, if the local is not well directed, the eye is sure to be lost, and although I would not depend altogether upon the local treatment, still if I had to take my choice of either the local or the general, I would certainly prefer the former, as a single mode of treatment.

Before I give the opinions of others I shall describe, in as short a space as possible, the local treatment adopted by myself in such cases. When met with in the early stage, I first cleanse the eye well with a sponge and warm water, then, if possible, evert the lids one after the other, beginning with the upper; I next sponge and dry the palpebral conjunctiva, then brush every part of it over, up to the line of reflection, with a hair pencil, previously wetted and applied to a piece of the nitrate of silver, upon doing which the whole part becomes white. I leave no part of the palpebral conjunctiva that I do not touch, even the caruncula and semi-lunar membrane, and if the sclerotic conjunctiva be much inflamed, but not ecchymosed, I pass the brush over it also; I then let a little milk pass over the eye, and, immediately after, restore the lids to their natural position. Every twelve hours thereafter I drop on the eye, and allow to remain there for four or five minutes, a large drop of the ten grain solution of the nitrate of silver; and if, in forty-eight hours after the first application, or even thirty-six hours, I find the purulent discharge not decreasing, I repeat the same treatment as on the first day, and use the ten grain solution as before. This treatment I continue until the inflammation begins to abate; then I substitute the saturated solution of the acetate of lead, which I continue until

the disease disappears. The above mode of applying the nitrate of silver is preferable to using it in pencil; first, because it can be applied more generally over the parts; and, secondly, if the patient starts, there is no danger of hurting the eye.

On the first day I give my patient a box of Jannin's ophthalmic ointment, and direct him to smear the edges of his eye-lids with some of it every night, when going to bed. I also give him the lotion hereinbefore mentioned when treating of simple conjunctivitis, desiring him to bathe his eyes with some of it on awaking in the morning, and also a couple of times during the day.

During this local treatment I adhere strictly to the constitutional, on the principles already laid down.

When there is chemosis I make no difference in the treatment, except to open the chemosis, in the manner recommended by Dr. Jacob.

The following remarks upon the treatment of this disease are from the pen of Mr. Guthrie:—"In the more formidable affection which runs its course in three or four days, neither the nitrate of silver, in solution, nor the *vinum opii*, is effective; it requires a more powerful local application. The disease begins externally, and is a local disease of a peculiar character; if we can set up a new action, or alter that which is going on, we check the original affection, according to the principle of John Hunter, that no two diseases or actions go on at one and the same time. Acting on this principle I took the nitrate of silver in substance, and made it into an ointment. I did not arrive at its exact composition at once, but gradually acquired it by degrees; it was made at various times, of five, six, ten, and twenty grains to the drachm; and after trying all these different preparations, I came to the conclusion that the ten grain ointment was the best. Take half a drachm of the salt and powder it in a glass mortar, then sift it

through a piece of muslin, so as to reduce it to an impalpable powder, for if there are any grains left they will stick in the cornea, or in the folds of the conjunctiva, and produce a slough. Ten grains of this impalpable powder should then be thoroughly incorporated with a drachm of hog's-lard, on a glass slab, with an ivory-paper-cutter; and in order to ensure proper attention in the preparation of this ointment, I sought for something to mix with it, which would require some time for its incorporation, and selected the liquor plumbi acetatis for this purpose. Fifteen drops are to be duly mixed with the ointment; and as it generally requires some minutes to do this, there is reason to believe that the trituration is complete. There has been, as usual, some dispute concerning this ointment. The first thing said, was that it was violent and useless; well, that has been got over. The second stage was to attribute the introduction of it to some other person. The third to alter the composition, and, instead of the liquor plumbi acetatis, to mix opium, &c., with it. I have no objection to this if the gentlemen will only leave me the principle, which is all I contend for. I care not if they change all the component parts, or whether they apply it with a brush, or the little finger, or the probe. It has been said that it soon becomes valueless and inert. All I can say is, let those who think so, have it applied to their own eyes, and they will soon change their opinions, even if it be a year old.

“Before the ointment is applied in this purulent inflammation, the discharge must be well cleansed out by a solution of alum; then the ointment having been inserted, the lids must be moved freely up and down, so that the whole conjunctiva gets its due proportion of ointment, and this is shown by its turning white. If it does not turn white, it has not been sufficiently applied, and will not answer the purpose; if we wish to be quite sure, we turn out the eyelids, and rub the ointment on them; this application gives

pain, which lasts from half an hour to an hour, or more; it is not quite so acute as the *vinum opii*. I had rather pain should last an hour or more, as the action going on is more likely to be changed. When I apply this ointment, I generally direct the patient to lose blood, not to the amount of sixty ounces, but to about twenty; and I had rather that he should faint. I do this because the application will only alter the action in the extreme vessels, and not that which is behind them in the ball itself; it is therefore necessary to diminish action in them by bleeding. If, however, the inflammation is moderate, I do not bleed at the time, leaving directions that if the patient is not better in the evening, or the next morning, blood should be taken. Warm narcotic fomentations, may be employed to relieve uneasiness, and opium should be given to allay pain and obtain sleep, while a solution of alum, half a drachm to half a pound, should be injected from time to time in the eye to clear it; but should the patient sleep he must not be disturbed. A mild ointment may be applied to the lids at night, to prevent their adhering together. The next morning the discharge is again to be removed and the ointment re-applied, for on no account should the action we are desirous of exciting be suffered to cease; the other remedies are likewise to be continued. In addition to these I would give calomel and opium so as to affect the mouth, and the other more common remedies; rest and diet should be attended to. When I hear of twenty or thirty persons losing their eyes from this disease, I say that it must always be so, unless they are treated on this principle, bearing in mind that some diseases in certain persons are incurable from the first, and that no means of cure are applicable to every case. I am certain, however, from experience, that the plan I have recommended is the most generally efficient and certain of any that has hitherto been advised, whilst it is also less injurious to the constitution."

The following are Dr. Jacob's remarks upon this mode of treatment:—"Whatever difference of opinion may exist with respect to the extent to which stimulating or astringent applications should be employed in the inflammatory stage of conjunctival inflammation, there is little doubt entertained of the value of astringents in the chronic stage, or that condition of the conjunctiva which may be considered the necessary consequence of the violent inflammation above described. The salts most commonly used for this purpose are acetate of lead, alum, sulphate of zinc, corrosive sublimate, and nitrate of silver. Notwithstanding the length of time these salts have been in use, it does not appear that any conclusive experiments have been made to ascertain their comparative value, or the best proportions in which they should be used. The practitioner has little more to guide him in the selection than the vague and uncertain evidence of expressions of confidence in some one or other by different practical writers.

"The most generally valuable, safe, and efficient, are the acetate of lead, alum, and nitrate of silver; the sulphates of copper and zinc being more stimulating and irritating with less astringent properties. Weak solutions, however, of sulphate of zinc and copper, are unquestionably of value in the slighter vascularity of the conjunctiva following catarrhal ophthalmia, or arising without preceding inflammatory action. Saturated solutions of acetate of lead or alum may be used with the greater safety, and without producing any such effect as follows the introduction of other salts; saturated solution of sulphate of zinc may also be applied to the conjunctiva without any other destructive consequence than a temporary increase of vascularity, pain, and weeping; but a saturated solution of sulphate of copper produces violent inflammation, probably acting chemically, and producing superficial destruction of the surface; nitrate of silver, in the proportion of ten or fifteen grains to

the ounce, appears also to act chemically, causing whiteness of the vascular conjunctiva, but without the irritating, stimulating effects of sulphate of copper. Nitrate of silver, even in the proportion of three or four grains to the ounce, if used for a month or six weeks, will produce an olive-colored indelible stain of the conjunctiva, and lamentable deformity; or both it and the acetate of lead, applied while ulcers of the cornea exist, produce the worst form of opacity, by being decomposed by the tears and deposited on the flocculent surface, and there detained until permanently fastened by cicatrization, as has been described by the author of this article, in the Dublin Hospital Reports. None of these disadvantages attend the application of the alum solution; and its powerfully astringent qualities are undeniable. The condition of the conjunctiva, to which the reader's attention is called with reference to these applications, is that which exists from a fortnight to six weeks after the first attack, when acute inflammatory symptoms have subsided, and before the membrane has acquired the extreme condition of disorganization denominated granular conjunctiva. In this state a solution of from four to five grains of nitrate of silver in an ounce of water, or the ointment recommended by Mr. Guthrie, will prove of great advantage; but the practitioner should not allow the praise exclusively bestowed upon it, to induce him to discard the saturated solution of alum, or acetate of lead; as he may be assured that they will often be found preferable in practice, although the particular condition in which they are so, may not have been ascertained. The effects of the saturated solution of acetate of lead, when such cases, modified by scrofula, are accompanied by vascularity of the conjunctiva covering the cornea, are frequently most remarkable."

Mr. Ware recommends the use of the *vinum opii*; he says:—"When first applied it causes a sharp pain, accompanied with a copious flow of tears, which continues a few

minutes, and gradually abates, after which a greater and remarkable degree of ease generally succeeds. The inflammation is often visibly abated by only one application of this tincture; and many bad cases have been completely cured by it in less than a fortnight, after every other kind of remedy had been used for weeks, and sometimes months, without any success. But this speedy good effect is not to be expected in all cases indiscriminately. In some the amendment is more slow and gradual, requiring the tincture to be made use of for a much longer time; and a few instances have occurred, in which no relief was at all obtained from its first application. In cases of the latter kind, in which the complaint is generally recent, the eyes appear shining and glossy, and feel exquisite pain from the rays of light. However, notwithstanding these symptoms, the application is sometimes found to succeed; and whether it will or not can be only determined by making the trial, which is attended with no other inconvenience than the momentary pain it gives. When it is found to produce no good effect the use of it must be suspended, until evacuations and other proper means have diminished the excessive irritation; after which it may again be applied, and bids equally fair for success, as in those instances in which it never disagreed. If two or three drops of thebaic tincture are dropped at once on the globe of the eye, the pain they occasion will be considerably greater than if they are placed on the inner angle of the eye-lids, and made to glide gradually on the eye, by gently drawing down the lower lid."

Gonorrhœal Ophthalmia.—It is stated in the last section, that the three descriptions of purulent ophthalmia differed rather in origin, history, progress, and consequences, than in any decided difference in the character and symptoms of the disease.

Gonorrhœal inflammation of the conjunctiva is divided into acute and mild; the local and constitutional symptoms

differing very little from those already described in purulent ophthalmia, the most remarkable difference in the local, being, that the inflammation generally begins in the sclerotic conjunctiva in this disease, whereas, in the purulent, it begins in the palpebral; all the symptoms are more violent in their progress in this form. There is generally but one eye affected, the puriform discharge is a darker color and thicker, giving the same stain to linen as that produced by the discharge from the urethra, in venereal gonorrhœa.

Mr. Lawrence, in describing the disease, makes the following remarks:—"The symptoms of acute gonorrhœal ophthalmia, are not equally violent through the whole course of the affection; it begins with swelling and increased redness of the conjunctiva, and some pain in the organ, then the puriform discharge takes place with increased uneasiness; and lastly, the inflammation extends to the cornea, with great aggravation of suffering. Thus the course of the affection may be divided into three stages, of which the limits cannot be marked very accurately. In the first there is vascular distension, swelling of the membrane, with swelling of the lids; the commencement of the second is marked by the occurrence of the puriform discharge, and that of the third by the extension of the inflammation to the cornea. The duration of each of these varies in different instances, according to the constitution and state of health of the individual, and perhaps still more according to the nature of the treatment adopted. This variety, however, is observed less in the first and second, than in the third stage; the two former, and more particularly the first, usually passing off very rapidly." The process by which the cornea sloughs he describes thus:—"The cornea becomes dull and hazy before it sloughs, or indeed before undergoing any of the changes above enumerated. Its transparency and polish are completely destroyed when it has sloughed; and it is converted into a dirty yellowish or brownish

opaque surface, which is immediately recognized as deprived of life. At first it looks like a portion of wetted leather; it is soon separated from the living parts, where it has a loose, soft, and ragged appearance. As the lens and capsule, which are exposed by this separation, are transparent, the patient sometimes recovers for a short period tolerably good vision. After the slough is detached the chambers of the aqueous humour may be exposed by ulceration; the humours will then escape, the empty coats will collapse, and the globe remains permanently shrunk in the socket. More commonly, although the whole cornea seems to slough, the entire thickness does not separate, and the anterior chamber is not exposed." With reference to suppuration of the cornea he says:—"Suppuration of the cornea may be general or partial; it is usually the former. The cornea first becomes white and then assumes a yellow color. The effused substance is not a fluid, nor is it collected into a cavity; it is a thick viscid matter deposited in the texture of the cornea. Ulceration takes place, and exposes an opaque yellow substance, which looks like ordinary matter, but it cannot be wiped off." Of the ulcerating process he says:—"If the ulcer should be spreading, the inflammation remaining unchecked, its surface is white and ragged, or flocculent, or of a dirty yellowish cast, with surrounding haziness. When the inflammation subsides it becomes transparent. The commencement of the restorative process is marked by the surface of the excavation assuming a light greyish tint, with a jelly-like appearance. A soft semi-opaque substance fills up the breach, when the surface becomes smooth, and the regular figure of the cornea is restored."

The reader must perceive how very little the symptoms and results of this disease vary from those of purulent ophthalmia.

Causes.—Such is the justice done by Dr. Jacob to the causes of gonorrhoeal ophthalmia, that I conceive I cannot

do better than to quote his words :—“In investigating the causes of gonorrhœal ophthalmia, inquiries highly interesting, even in a general point of view, are suggested. It has been supposed that the specific form of gonorrhœal inflammation, existing in the urethra, is transferred to the conjunctiva, by that obscure and inexplicable transition, which is denominated metastasis, respecting which we know little more than the fact of its occurrence. This metastasis never has, and perhaps never can be proved to occur, because there can be little doubt that the contact of gonorrhœal matter with the conjunctiva produces the disease of the eye, and it is impossible to prove positively that such contact does not take place in all cases of gonorrhœal ophthalmia. Every individual affected with gonorrhœa must have the fingers contaminated by the discharge, notwithstanding the most scrupulous cleanliness and care ; and the application of the fingers to the eyes for the removal of any irritation there, is so habitual, that it becomes an involuntary act, which nothing but continual watchfulness could prevent, and which may occur even during sleep when the patient is unconscious of it. It is true that a person may be so attentive to the prevention of this occurrence, by the utmost precaution and cleanliness, as to render it highly improbable that a particle of matter has been applied to the eye ; but the physician can only say in such a case, this is most probably metastasis of gonorrhœa to the eye, but cannot safely assert positively that it is so. Whilst it appears thus impossible to say with certainty that metastasis has occurred, it is equally impossible to prove that it has not ; and many facts and arguments may be adduced in favor of the conclusion that this is the mode in which the disease originates. The disease of gonorrhœa affords other apparent examples of metastasis. The violent inflammation of the testicles produced by the suppression of the discharge from the urethra, is surely rather of this character

than an extension of the mucous inflammation along the lengthened and tortuous tube of the vas deferens. Irritable bladder, produced by the same cause, is also most probably independent of a continuous extension of the specific inflammation along the whole length of the urethra, to the lining membrane of that organ; and even sympathetic bubo generally presents a character so different from that which arises from the extension of irritation along the absorbents, to the lymphatic glands, from simple injury, that it is not unreasonable to attribute it to metastasis. These metastases are of comparatively rare occurrence; so is gonorrhœal ophthalmia, notwithstanding the probability of the frequent application of the matter to the conjunctiva or its vicinity. The occurrence of the disease in one eye without extending to the other, notwithstanding the profuse discharge so likely to come in contact with the unaffected organ, makes it highly probable that the disease depends on a cause different from mere contact of infectious matter. Whatever doubt may be entertained respecting the occurrence of metastasis, evidence sufficient to prove that the disease can be produced by the contact of gonorrhœal matter, both in the individual laboring under the disease of the urethra, as well as others, is on record. Mr. Lawrence, Mr. Wardrop, M. Delpech, Mr. Bacot, and others, state instances in which there could be no doubt of the fact. The writer has heard this assigned as the cause of the disease, by a young man, who, without any leading question, or knowledge of the usual production of inflammation of the eye by such a cause, stated circumstantially the fact, of gonorrhœal matter having been projected into his eye while retracting the prepuce, which confined a quantity of the discharge. Dr. Vetch details a solitary case in which the experiment was made to determine this matter by an hospital assistant, where gonorrhœal matter was applied to the conjunctiva with impunity. It does not, however, appear

that Dr. Vetch himself conducted the experiment, and it is obvious that much confidence could not be reposed in the accuracy of an individual so imprudent, and thoughtless, as to incur such a risk. While it may be admitted that the contact of gonorrhœal matter to the eye produces conjunctival inflammation, it is by no means proved that it uniformly has this effect. Some individuals may possess this dangerous susceptibility, and others not; and even the same individuals may at one time suffer from the contamination, and at another time not. Should it be established by observation that this is the fact, it would be an important illustration of the general question of contagion, proving that a morbid poison, directly applied to a circumscribed spot, produces effects at one time and on one person, which are not observed on other persons, or on different occasions. Upon a candid consideration of this subject, it must be admitted that it is the duty of the practitioner to warn patients laboring under gonorrhœa, of the danger they incur by negligence or inattention, with respect to the precautions necessary to prevent the communication of the disease to the eye."

After giving the above valuable remarks by Dr. Jacob, I feel that but little remains to be said on the causes of gonorrhœal ophthalmia. I do not consider that there is any sufficient proof, or probability of the disease being caused by metastasis, but it is more than probable that it is caused by contagion; and I see nothing more remarkable in the fact that a person should be susceptible of it at one time and not at another, or that one person should be more susceptible of it than another, than, that a child should be vaccinated two or three times, with the same infection, before it produces any effect; or that two children should be vaccinated by the same person, at the same time, with the same lancet, and infection, and one of the children become infected and the other not; nor is it more strange than

that two persons of the same age, habit and constitution, should be equally exposed to the same contagious disease, and one of them become sick, while the other, who was in equal danger, escapes. That these things occur every day there is sufficient proof, but why they occur, is not so easily explained.

The following statement is made by Mr. Mackenzie :—
“Different views have been entertained of the purulent inflammation of the conjunctiva, which is frequently found to attend, or succeed to gonorrhœa. 1st. This ophthalmia has been ascribed to inoculation with matter from the urethra; 2ndly. It has been supposed to be by metastasis; And 3rdly. It has been considered, at least in certain cases, as an effect owing to irritation merely, without either inoculation or metastasis. It is quite possible that there may be three such varieties of this ophthalmia. The existence of the first I consider beyond all doubt; but the second and third are somewhat problematical.”

Mr. Samuel Cooper makes the following remarks :—“If it be actually true that in adults a species of purulent ophthalmia does originate from the sudden suppression of gonorrhœa, are we to consider the complaint so produced as a metastasis of the disease from the urethra to the eyes. This ophthalmia does not regularly follow the suppression of gonorrhœa; nay, it is even a rare occurrence; also, when it is decidedly known that the purulent ophthalmia has arisen from the infection of gonorrhœa, namely, in those instances in which the matter has been incautiously communicated to the eyes, it appears that such an affection of these organs, so produced, is different from the one alluded to, inasmuch as, it is slower in its progress, and less threatening in its aspect. Hence there is good reason for supposing, that no metastasis takes place in this species of purulent ophthalmia, supposed to be connected with a sup-

pressed gonorrhœa; but we must be content with inferring, that if it really has such a cause, it originates with a sympathy, prevailing between the urethra and eyes, and that the difference of irritability in different people is the reason why it is not an invariable consequence of the sudden stoppage of a gonorrhœa." The following opinion of Sir A. Cooper's is worthy of note:—"Another, and one of the most violent forms of purulent ophthalmia, is that which is called gonorrhœal, from its being produced by the application of gonorrhœal matter to the conjunctiva."

There is another remarkable fact, which is a strong proof of this disease being produced by contagion, viz:—that men are much more liable to it than women.

Prognosis.—When in the short space of forty-eight hours, this disease may produce a total loss of vision, it is evident that the practitioner must be very cautious in his prognosis, but more particularly so if the disease is in the advanced stage. The following statement is made by Mr. Lawrence:—"So short a period intervenes, between the commencement and the full development of the complaint, that in many instances irreparable mischief is done to the eye before our assistance is required. If we see the complaint in the first or second stage, we may expect to arrest its progress by active treatment; but success does not invariably attend our efforts; our prognosis will principally turn on the state of the cornea; if that should possess its natural clearness, the eye may be saved. If it should become hazy and dull, and more particularly, if it should have assumed a white nebulous appearance, consequences more or less serious will inevitably ensue. Great swelling of the conjunctiva, more particularly great chemosis, profuse discharge of a yellow color, and bright redness of the swollen upper eye-lid, are unfavorable circumstances, as indicating a high degree of inflammation. When both eyes are attacked in

succession, the disease is less severe in the second, which therefore is usually saved; sometimes, however, the inflammation is equally violent in both."

Treatment.—Of the treatment of gonorrhœal ophthalmia there is but little to add to that already said, under the head of purulent ophthalmia. There are just as many different modes recommended: those who advocate the anti-phlogistic treatment and mercury, in the purulent, consider it necessary to push it even farther in the gonorrhœal; and those who recommend the stimulating local treatment in the former advise the same in the latter. For my part I treat both diseases in the same way; but I consider that if mercury is of use in either form, it is in this, although I think its good effects appear, chiefly, after the inflammatory stage is over. Among those who believed in metastasis were Richter, Scarpa, and Beer, all of whom recommended the reproduction of the discharge from the urethra, by passing a bougie into it, smeared with warm oil. I need scarcely say that such trifling, with so fearful a disease, is not to be commended.

Purulent Ophthalmia of Infants.—Dr. Jacob gives it as his opinion, that this disease is so formidable that loss of vision is produced by it, in perhaps four times as many instances, as from all the cases of common purulent and gonorrhœal ophthalmia. Now though I fully agree with the worthy Professor as to the number of children that lose their vision from this disease, still I do not agree with him, as to the cause; for my idea of the true cause, is, a neglect, on the part of those having charge of the child, to apply to the proper source for treatment, till it is too late, or the practitioner trifling with the disease, either from his supposing it to be something very simple, or recognising, but not treating it properly.

On about the third, or fourth, day after birth, it may be sooner or later, this disease makes its appearance. The eye

becomes moist, and is soon followed by redness of the lids ; a small quantity of purulent matter is then seen to collect in the inner canthus of the eye, and this is generally the first thing that attracts the notice of the friends of the child. If at this period the surgeon sees the child, he will find the sclerotic conjunctiva to be red or blood-shot, the child will shun the light, become restless, and seem to suffer great pain. All these symptoms soon increase in violence ; the redness of the conjunctiva, the purulent discharge, the intolerance of light, and the swelling of the lids ; so that in no degree does it differ from purulent ophthalmia, except in the conjunctiva rarely, if ever, becoming chemosed. The discharge is sometimes tinged with blood, and if the child should be jaundiced, it has a greenish tint. The tumefaction of the eye-lids is always enlarged by the crying of the child. When the disease goes on to the destruction of the organ, the course it pursues is well described by Mr. Saunders :—“ As the disease advances the cornea becomes more or less cloudy, and by the extent of this cloudiness the degree of approaching slough is marked, for the whole of the cornea, if the whole become cloudy, will alternately slough, and the form of the eye be totally destroyed. I do not mean to say that in every instance in which opacity of the cornea is apparent, the cornea is about to pass into a sloughy state ; on the contrary, opacity is often the mark of a healthy action commencing around the breach of the cornea, for the purpose of restoring the part, and ought to be hailed as a happy omen. I am now speaking of a peculiar duskiness of the cornea, which begins during the progressive state of the inflammation, which is antecedent to any loss of substance, but is indeed a sure sign that such loss is about to take place. When this duskiness comes on, supposing only a portion of the cornea about to slough, the extent of it, in about the course of twenty-four hours, becomes definite ; in the same space of time it

becomes elevated, and apparently lessened in extent; a groove or fissure forms between it and the rest of the cornea; portions of it are carried off by the discharge and tears; or sometimes it separates altogether in one mass. I have several times washed out with a syringe these little sloughs entire. But although I am as certain of the fact as the most frequent observation can make me, I am equally sure that most commonly, when this disease destroys vision, the destruction is accomplished in a more gradual manner, not by a slough of very considerable extent, and through the whole depth of the cornea at once, but by a succession of sloughs. In others words, the ulcer left, by the casting off of the dead piece of cornea, becomes in turn sloughy, and extends itself by a succession of sloughy surfaces, until the last lamina of the cornea sloughs, or being protruded from the pressure from within, ulcerates, and the aqueous humour escaping, the iris passes through the breach of the cornea. Already the whole surface of the eye has been in an ill-conditioned inflammation; the ulcer, or rather the surface of the cornea around the protruding iris, indisposed to heal, so that more and more of the iris protrudes; this in turn ulcerates, and the crystalline and vitreous humour all issue at the orifice. That the inflammation itself immediately destroys the parts by sloughing, or ulceration, is a truth of which I am perfectly convinced." Mr. Mackenzie, commenting on the remarks of Mr. Saunders, says:—"Mr. S. is wrong in supposing the cornea is destroyed by the process of sloughing." Dr. Jacob says:—"Whether the inflammation be erysipelatous or not, may be ascertained when pathologists have determined what the term erysipelatous, so applied, means. If the cornea ever sloughs in severe inflammation of the conjunctiva, it may be admitted that it does so in this, especially if men of experience agree that such is the case. Mr. Mackenzie is undoubtedly right in stating that the eye is lost in this disease frequently by abscess; and the

fact perhaps is, that the two processes are often combined; the dirty ragged ulcer consisting of open abscess with sloughy surface, and being very much of the character of anthrax. Whatever opinion may be entertained, respecting the precise nature of the destructive process, the practitioner should never lose sight of the danger to be apprehended from it. It commences during the active period of the inflammation, but continues after it is mitigated, and if not arrested, terminates in destruction of the organ."

Although I have said that this disease usually commences some few days after birth, yet there are those who believe that the disease commences before the child is born. John Walker, Esq., of Manchester, makes the following report in the London *Lancet* for February, 1840:—"You will probably agree with me in thinking that this disease may arise from a number of causes, one of which may be some such secretion as that alluded to, and another a peculiar congenital predisposition. This extraordinary case I will state a little in detail, since, as far as I know, there is no similar one on record, although probably others must have occasionally occurred. The child, when first brought under my notice, was six months old; and the mother, a very intelligent person, informed me that at the time of birth, its eyes exhibited the same appearances as were now observable. The disease had run through its entire course previously to birth, for according to her account, there was no puriform discharge, inflammation, or intolerance of light, noticed at any time subsequently. The cornea of one eye had completely sloughed, the eye-ball had sunk, and, of course, not the slightest vision existed. More than one half of the cornea of the other eye was opaque; through the remaining transparent portion a part of the pupil could be discovered, and the iris and cornea appeared almost in contact. The transparency gradually extended, and more of the pupil became accessible to light; hence, though vision

was very imperfect when I last saw the child, yet it appeared to be gradually improving.

“ Now, after duly considering how perfectly the phenomena presented by the eyes of this child, agree with those met with, as results of purulent ophthalmia attacking infants after birth, I think that no reasonable doubt can be entertained that they were occasioned by purulent ophthalmia which occurred before birth. This is not the only case I have met with affording evidence of active disease of the eyes having been present during the uterine period of existence. Some few years ago, I saw a child, then only two or three days old, the cornea of each of whose eyes was opaque throughout, and unusually large and prominent, so that very little of the sclerotica was discernible. The opacity was of a bluish white color; there was scarcely any irritation about either eye; nothing like inflammation. I merely prescribed some palliative remedies, regarding the case as one of malformation, and thinking that this would probably be permanent. The child, however, when about two years of age, was again brought to me on account of some slight inflammatory condition of the eyes, and I was surprised to find that they had a perfectly healthy appearance, the cornea having become quite transparent and of normal size.”

There is no doubt but that children have been born with opacity of the cornea, as well as with opacity of the crystalline lens: therefore there is nothing to wonder at, that the eyes should suffer in other respects during the time the child is in utero; but I think the above remarks are not sufficient evidence, to warrant the conclusion that purulent ophthalmia took place before birth, as in the first case quoted by Mr. Walker. Although the woman were ever so intelligent, I should much doubt her story, for we all know how much people exaggerate in these things; and even how incapable a woman is, of forming a sound opinion on the state

of her child's eyes, immediately after birth. As to the second case, neither the appearance of the eyes when Mr. Walker first saw the child, nor the state in which he found them in two years after, bear much resemblance to the result of purulent ophthalmia.

Prognosis.—Although, in the majority of cases, I conceive this disease to be under the the control of the surgeon, if he sees it in the first stage, still he should be very cautious in his prognosis ; for sometimes, under the very best directed treatment, although the organ may be saved from abscess or sloughing, there may be other evil consequences of the inflammation, such as opacities of the cornea, or the capsule of the lens, short-sightedness, oscillation, strabismus, incomplete amaurosis, &c. There is one termination, of the other two forms of purulent ophthalmia, that is never to be dreaded in this, viz :—granular eye-lids. Before the surgeon gives an opinion he should clean the eye and examine it well, so as to see the whole of the cornea, when, if it presents that dusky appearance, intimating the process of slough, he should at once prepare the friends of the child for the worst results ; but he should not send the child away as a hopeless case. If the cornea is clear and healthy, his prognosis must be favorable, but he should always bear in mind that the patient is liable to relapse, which renders the chances of a successful issue even less than at the first appearance of the disease. The surgeon must also remember that, if the cause of the ophthalmia is gonorrhœal discharge getting into the child's eyes during parturition, the case is much more dangerous than if it arose from any other cause.

Dr. Jacob, when speaking of children being brought to the practitioner after the end of a week or fortnight, says :—
“ When an infant at this period of the complaint, is presented to the practitioner, he should at once satisfy himself, whether the cornea be safe from slough, abscess, or ulceration, or, as this is attended with some trouble, if leisure does

not permit him to do so, he should inform the parent in plain and intelligible language, that there is danger to be apprehended, and that the child may have its vision impaired or destroyed by opacities of the cornea, which cannot at the moment be perfectly distinguished. If he dismisses the patient without this precaution, or if he makes any application to the eye without explicitly announcing the extent of the injury, the reproach of having blinded the child will be fastened on him by those who, from culpable negligence, ignorant confidence in their own opinion, or sordid love of money, had caused so lamentable a misfortune. If upon examination in this after period of the disease, the cornea be found perfectly clear and free from ulcer of any kind, the practitioner may entertain sanguine hopes of perfect recovery, but he should not, even then, give expression to these hopes, as relapse may occur, or some accidental circumstance interfere with the cure. If slough, abscess, or ulcer, have not taken place in the first week or ten days, there is every reason from experience to expect that no further bad consequences are to be apprehended than the troublesome and distressing vascularity, with profuse purulent discharge, which often, especially if not checked by astringents, continues for six weeks or more."

The following remarks are by Mr. Mackenzie:—"Whenever the person who brings the child to me, announces that the disease has continued for three weeks or longer, I open the lids of the infant, with the fearful presentiment that vision is lost; and but too often, I find one or both of the corneæ gone, and the iris and humours protruding. In this case it is our painful duty to say that there is no hope of sight."

Causes.—If we are perfectly satisfied that this disease does not occur before birth, it is easy to account for the causes which produce it, but if, on the contrary, we receive Mr. Walker's theory, of its occurrence before birth, then we

are at a loss to know how it originates. A sure way of producing the disease in the worst form is by infection, and this is generally caused by the mother having either a leucorrhœal or gonorrhœal discharge at the time of parturition. Exposing the child's eyes to strong light, or a draught of cold air coming on the child, immediately after it is expelled from the warm uterus, will be sufficient cause to produce the disease; however, there are some cases of inflammation from the latter cause, only catarrhal, which never terminates in purulent ophthalmia, unless it is produced by neglect or improper treatment.

Treatment.—Previous to making any remarks on the treatment of this disease I would venture a little advice to the accoucheur, that he may if possible use such precautions as will prevent the occurrence of this formidable disease. First, he should know, previously to the woman being delivered, whether she has at the time any discharge from the vagina, of the character above alluded to, and if so he should have a sponge and warm water ready at hand to wash and clean the child's eyes previously to its opening them.

After the child is born he should warn its friends not to have it brought into a draught of cold air, nor to allow its eyes to be exposed to strong light. At every visit paid to the mother for a few days, he should look at the child's eyes, so that, should inflammation make its appearance, he will see it in the first stage.

This disease, like the other varieties of purulent ophthalmia, is subjected to a number of treatments differing from each other. I have never found any difficulty in curing it when I see the case in the early stage, and my treatment is as follows:—I first sit down and place a clean towel on my knees, and on the towel I have the child's head laid, its body being held in the arms of the mother or friend; this gives me full power over the child's eyes. I then by open-

ing and shutting the lids with my finger and thumb, and using a sponge and warm water, clean all the purulent matter from the eyes; this being accomplished, I dry the eyes, perfectly, with a small soft towel, and immediately afterwards drop on the conjunctiva a large drop of the ten grain solution of the nitrate of silver, which I allow to remain there for about one minute, and then remove it and wipe the eye perfectly dry. This treatment I repeat every twelve hours, until both the discharge and irritation become lessened, but as the disease abates I use the saturated solution of the acetate of lead. I always give the nurse a six or eight grain solution of the sulphate of alum, ordering her to wash the child's eyes with it constantly during the day, and to keep bits of rags, wet with the lotion, laid upon the child's eye-lids whilst it is sleeping. The removal of the purulent matter, previous to the use of the nitrate of silver, is of the greatest importance, for if this is not done the application does not get on the inflamed part.

The constitutional treatment that I adopt is as follows:— If the child is of full habit, I give, in the first instance, an emetic of the vinum ipecacuanhæ, and after this, a dose of oil; but, under any circumstances, I have the bowels kept regular by an occasional dose of oil.

If, as already stated, I see the case at the commencement of the disease, I never find the above treatment to fail in curing it in the course of four or five days; at least the discharge stopt, and nothing remaining but a little vascularity of the conjunctiva, which soon disappears. But if the disease has been of long standing, so as to be well developed, then if the discharge stops in the course of five or six weeks, without leaving any evil results, I feel well satisfied. My treatment is the same (that is the local) even if ulceration of the cornea has set in, and if the ulcer is inclined to spread, I touch it with the pure nitrate of silver, and immediately afterwards bathe the eye with a little warm milk.

The constitutional treatment I then change to tonics. If the iris becomes prolapsed, I treat it as already laid down in the article under that head.

Dr. Jacob advocates the use of leeches in the inflammatory stage; he says:—"As soon as the existence of the disease is fully ascertained, a leech should be applied over the cheek bone, at the edge of the orbit, and blood allowed to flow until the effect of the bleeding becomes obvious by the paleness or sickness of the infant."

Speaking of the use of calomel in such cases he remarks:—"If it be admitted that the administration of calomel influences the biliary secretion, its use is particularly indicated at this period of life, when the liver performs an office in the animal economy of still greater importance than it does at more advanced periods." Speaking of local applications, he remarks:—"Local applications may be resorted to with two objects,—the alteration of the nature of the inflammatory action altogether, or the diminution and removal of the purulent discharge. For the former object, the nitrate of silver is recommended, and it cannot be denied that it may effect it; but it must at the same time be confessed that the practice has not yet been fully submitted to the test of experience. The question for consideration is, whether a practitioner, as soon as he has ascertained beyond doubt the existence of this severe form of inflammation, can with safety, and a fair prospect of advantage, introduce a solution of nitrate of silver of ten grains to the ounce, or an ointment of ten grains to the drachm, between the lids. That this and other astringents may be used with success to put a stop to the purulent discharge, after the first symptoms of inflammatory action have been subdued, cannot be doubted. With this view a five grain solution of the nitrate of silver, or a saturated solution of the acetate of lead or alum, may be resorted

to; the acetate of lead cannot, however, be employed if slough or ulcer be present."*

Phlyctenular or Scrofulous Ophthalmia.—By this title I must not be understood to mean an inflammation of the conjunctiva, which is a specifically distinct disease; but rather an inflammation of the conjunctiva, modified by a scrofulous diathesis; the result of which is the formation of phlyctenulæ of the conjunctiva. According to the views of Dr. Jacob, (in which I fully agree with him,) "every form of inflammation of the eye is liable to assume the scrofulous character, except the purulent ophthalmia of children, which is not so modified in consequence of the organization of the system at that time of life."

Symptoms.—The chief characteristic symptoms are phlyctenulæ on the edge or surface of the cornea, with more or less redness of the conjunctiva, blepharospasmus, and great intolerance of light, particularly of artificial. Exposing the eye to the light, produces pain, sneezing, and profuse lachrymation. The eye-lids appear as if swollen; but this is produced by the tears being collected between the lids and eye-ball, and consequently disappears on the opening of the eye-lids, when a gush of scalding tears runs over the cheek, the constant repetition of which, causes the lower eye-lid and cheek, very frequently, to become excoriated. Such is the dread the patient has of the light, that he keeps his head bent down, and if a child, which it generally is, buries its face in its mother's lap, on her shoulder, or any other convenient place, such as a sofa, bed, chair, &c.; and, when in bed it will lie on its face, although the room should be perfectly dark.

* In the *Revue Medico-Chirurgicale* for September, 1849, there is a paper by Mr. Chassaing, in which he puts forward the theory that a pseudo-membrane is formed on the conjunctiva in purulent ophthalmia; in the same manner as that description of membrane is formed on the larynx in croup, viz.—by lymph being effused. I doubt very much the existence of such a membrane on the conjunctiva; nevertheless, I would not say but such an occurrence might take place under peculiar circumstances.

If a child suffering with this disease has not all the characteristics of a scrofulous subject, such as thick upper lip, thick *alæ-nasi*, occasional ulcers on the corners of the mouth and nose, discharge from the ears, or the glands of the neck swollen; yet they will be found to have the tumid hard abdomen and irregular bowels, which are always to be found in strumous children. If the case goes on favorably it generally terminates by the *phlyctenulæ* becoming absorbed, and leaving a small *albugo* in its place, which generally is absorbed in time; not always, however, for it sometimes spreads by additional lymph being supplied to it, from one or two vessels which will be seen to run into it; then the *albugo* rises above the level of the cornea, its removal becoming very tedious. To this description of *albugo*, Mr. Mackenzie gives the name of vascular speck, but it is generally called vascular *albugo*.

Unfortunately *phlyctenular ophthalmia* does not always run so favorable a course, for much more frequently are the vesicles found to suppurate and burst, leaving ulcers on the cornea either extensive and superficial, or small in extent but deep into the substance of the cornea. This occurrence causes an increase in the severity of the symptoms, the pain, intolerance of light, and profuse lachrymation, being much more severe, owing to the extreme twigs of the ophthalmic branch of the fifth pair of nerves becoming exposed, by ulceration, to the light and atmospheric air. There are many evil consequences to be dreaded from this ulceration of the cornea; indeed, some are unavoidable; if, for example; the ulcer heals, as there has been a loss of substance, there must remain an opacity, from the cicatrix that follows. This opacity of the cornea is termed *leucoma*, and can never be completely removed, although it will become much smaller as the lymph surrounding it is absorbed. The ulcer may penetrate into the anterior chamber of the eye, causing a loss of the aqueous humour and a pro-

lapsus of the iris through the cornea ; to which the term *myocephalon* is given, from its resemblance to the head of a fly.

A large portion of the cornea may be destroyed by the ulceration, down to its lining membrane, which, not being able to support the aqueous humour, becomes protruded through the ulcer in the cornea ; to which the term *hernia corneæ*, is given. The continued inflammation of the conjunctiva, which is always present in this disease, sometimes spreads to the different tunics of the eye, producing internal scrofulous ophthalmia. The parts of the eye most liable to suffer first, are the sclerotic coat and iris.

When this inflammation spreads to the internal part of the eye it generally leaves the capsule of the lens opaque, the pupil being partially closed, and the eye more or less amaurotic ; and sometimes the whole eye-ball becomes atrophic. Children who suffer from constant attacks of this formidable disease, become in time more or less amaurotic from the injury the ophthalmic branch of the fifth pair of nerves receives. It very frequently leaves, an incurable, *ophthalmia tarsi*.

Phlyctenular ophthalmia is a disease of very frequent occurrence : indeed so frequent that authors have stated that ninety in every hundred cases of ophthalmia in children are of this character ; my experience in Canada would lead me to the same conclusion, at least so far as concerns the children among the lower classes, in which this disease is mostly found, although no children are secure from it. It generally disappears altogether at the age of puberty, particularly in females, but very frequently at about eight years old.

Adults seldom or never suffer from this disease unless they have previously been attacked with it in childhood.

Phlyctenular ophthalmia is generally accompanied with eruptions on both the face and head ; I have never found

any author who gave a reason for these eruptions occurring in children of a strumous diathesis; all have contented themselves with simply stating that such is the case; but the nature of their origin, I consider an important question. I conceive that the cause may be traced to some peculiar state of the fifth pair of nerves; the integuments covering the face and head, as well as the mucous membrane lining the eyes, nose, &c., receive sensation from the fifth pair of nerves; now it is an acknowledged fact, that if the ophthalmic branch of the fifth pair of nerves be paralysed the result will be ulceration of the conjunctiva and Schneiderian membrane. I therefore consider that, reasoning from analogy, we may suppose that if the whole of the fifth was paralysed, the integuments it supplies will also ulcerate, although perhaps not so soon as the mucous membranes, which are supplied by this nerve. I do not say this must necessarily follow paralysis of the fifth, but when we remember the similarity there is between the integuments and mucous membrane, and that both are supplied by branches from the same nerve, I repeat, that I consider the above conclusion to be reasonable, and certainly deserving of enquiry by those pathologists who devote much of their time to skin diseases.

Causes.—The causes of this disease are *remote* or *predisposing*, and *exciting*. I am satisfied that the great predisposing cause which modifies inflammation of the conjunctiva, producing that disease called phlyctenular ophthalmia, is that the morbid strumous poison, whatever that may be, attacks the ophthalmic branch of the fifth pair of nerves, and thereby destroys its use in a greater or less degree, so that its nutritious powers, necessary for the healthy eye, are suspended. Moreover, I believe that if in addition, other strumous affections appear about the head, face, &c., it is a proof that the whole of the fifth is disordered to a greater degree; in fact that the fifth nerve is so disordered that it produces the same effects as if it were partially paralysed.

There are many exciting causes which bring this poison into action, such as improper food, impure air, want of exercise, bad clothing, want of cleanliness, and though last not least, a cause which few can guard against, a variable climate. The primary inflammation of the conjunctiva may be produced by cold, wet, teething, injuries, excessive use of the eyes, or any of the eruptive fevers.

Prognosis.—As there is no disease of the eye more liable to a relapse than this, or one that more depends upon the careful attention of the friends of the child, great caution must be observed in giving a prognosis. The practitioner must by no means make light of the complaint, and lead the friends of the child to believe that the case will soon get well; for the reare many uncontrollable causes to prevent it, and if his prognosis does not turn out to be correct, he is sure to be blamed; therefore, he should plainly tell the friends all the dangerous consequences which may result from the disease, that there is no security against a relapse, and that the cure may be tedious under the most favorable circumstances.

Treatment.—As a general rule perhaps there is not one disease of the eye less under the control of the practitioner than strumous ophthalmia, nor is there one which is subjected to more various modes of treatment, all appearing equally successful at one time, and unsuccessful at another; indeed, like inflammation of other parts modified by scrofula, it will at some periods successfully oppose the very best directed treatment. The surgeon must always bear in mind that this disease is dependent upon a constitutional cause, the removal of which must claim his chief attention, while he does not neglect the local treatment.

Believing, as I do, that the nutritive powers of the diseased eye are diminished, I cannot recommend blood-letting in any way, nor any other debilitating-remedies. However there are those who recommend the application of leeches.

Mr. Mackenzie says :—" When the inflammatory action runs higher than ordinary, or when it is suddenly or violently augmented by the formation of ulcers on the cornea, it is proper to moderate the impetus of the blood by the application of leeches to the eye-lids or temple." I do not think the surgeon can commence his treatment better than by giving the following advice to the friends of his little patient: viz :—If the child is living in an impure atmosphere, let it, if possible, be removed to a pure one ; let him be well clad particularly with flannel next the skin, and let him have good nutritious food. Pay particular attention to cleanliness, and keep the child in a large, well lighted, and moderately warm room, and let him be brought out into the pure air when the weather is fine. He should be encouraged to play with his companions, and not allowed to keep his head buried in his nurse's lap, or on her shoulder ; even when in bed he should be made to lie upon his back, having his head raised by means of pillows. If the practitioner can get the friends of the child to attend to the above directions, he will have accomplished the most important part of the treatment.

As the hard tumid abdomen of strumous children is caused by an acrid irritating substance, collecting in the stomach and bowels, the first thing indicated is to get rid of such collection, and the second to prevent its re-collection. These I consider best done by giving an emetic of ipecacuanha, followed up by an aperient of rhubarb ; then one of the following powders to be given every night, supposing the patient is a child of about two years old :—

℞ Pulv. ipecacuanhæ, gr. ii.

Carb sodæ. gr. vi.

Pulv. rhei. gr. xii. M divid. in chart. vi

The soda acts as an ant-acid, the rhubarb as a gentle aperient, and the ipecacuanha as a tonic, at least I consider it to be such when administered in small doses ; it has also

a well known sedative action upon inflamed mucous membranes: I never give it in nauseating doses, indeed I never give nauseants in this disease at all, for they debilitate the system as much as bleeding, and produce an evil result.

After giving the above powders until the hardened abdomen has disappeared, and there is a decided change in the secretions, which is generally after the end of a fortnight, I then give tartarised antimony and quinine,—the former as a sedative and gentle diaphoretic, the latter as a tonic. The largest dose of tartarised antimony that I give to a child is one twelfth of a grain three times a day, and the largest dose of quinine half a grain. These medicines are best administered in solution, as recommended by Mr. Mackenzie, but they may also be given in powders. If one twelfth of a grain of tartarised antimony produce the slightest nausea, the dose should be reduced to one twentieth. Care should be taken not to give too strong diaphoretics, as profuse perspiration in such cases is always hurtful.

Since these remarks were written I met with an article in the *British American Journal*, taken from the *Philadelphia Medical Examiner*, on the effects of large doses of quinine, by William Thom, M. D. Among the numerous evil effects produced, by large and frequently repeated doses of quinine, he mentions partial amaurosis, and in describing a case, says:—"The quantity taken in three days is not accurately known, but I should think was not much less than two scruples. As soon as the constitutional effects of the medicine were induced the disease yielded; but dilatation of the pupil, insensibility to light, and almost total loss of vision, followed. The amaurotic condition slowly improved without remedies and he is now perfectly restored."

Now this injurious effect of large and repeated doses of quinine, on the ophthalmic branch of the fifth pair of nerves, should not deter the practitioner from using it in small doses. Nay, I would rather consider this an encouragement to

use it moderately, as it affords such a proof of its direct action upon that nerve, which, as has been already stated, I believe to be poisoned in strumous ophthalmia.

Some recommend mercury as an alterative in strumous ophthalmia, I must confess that my experience has given me but little faith in it ; it may, however, be of use when the inflammation spreads to the iris. Mr. Hamilton of Dublin recommends it as a tonic, and acknowledges himself indebted to Sir P. Crampton for the knowledge of its utility. The preparation he recommends, is the oxymuriate of mercury, which he says is to be given in small doses, that it may act as an alterative or tonic. But he afterwards makes the following remarks, which prove, that it is as a tonic he values it :—"Salivation is, I think, if possible, to be avoided ; when it has occurred in my practice, though there has usually been decided amendment, I have not trusted to it, considering such improvements as not likely to be permanent ; I have, after discontinuing the remedy for some days, resumed it in much smaller doses."

The dose he recommends for children is the one-sixteenth, or one-twelfth of a grain, twice a day : and to adults the one-twelfth or one-eighth. It is to be combined in a little tincture of cinchona, or rhei, or, sometimes, spirits of wine, and to be taken one hour after meals.

I have frequently tried this treatment and have found it very valuable, particularly among the lower class of children, where there was no possibility of providing them with proper food, air, or clothing.

Iodine has been given in this disease, and sometimes with the very best effects. The best preparation is the ioduretted iodide of potassium. In *La Revue Medicale* for April, 1840, Dr. Pay, of Aix, in Provence, speaks highly of the benefit to be derived, in cases of strumous ophthalmia, from the use of the hydrochlorate of baryta. I can say nothing of its use as I have never given it a trial. Much

having been written latterly on the benefit to be derived from the use of cod-liver oil in scrofulous cases, I have, in consequence, given it a trial in strumous ophthalmia, but found no benefit from it.

Local Treatment.—Seeing that the ophthalmic branch of the fifth pair of nerves is, as well as being sensible to the stimulus of light, the nutritive and secretive nerve of the eye; and that it is this nerve being poisoned which modifies inflammation of the conjunctiva, producing phlyctenular ophthalmia, I conceive that every effort should be made in the local, as well as in the constitutional treatment, to restore this nerve to its healthy action.

Finding that veratria was recommended by Dr. Turnbull for the cure of neuralgia, gout, rheumatism, and some forms of paralysis, I was induced to try it in various cases of disease of the eye, where I could trace the affection to any disordered state of the ophthalmic branch of the fifth pair of nerves; and I have found it productive of the very best effects. Its immediate effects, in strumous ophthalmia, are to remove the morbid irritability of the extreme filaments of the fifth, and thus get rid of the painful sensibility to light, profuse lachrymation, and blepharospasmus; and this is doing much towards accomplishing the object in view. I believe it even does more than this, for, by giving the nerve its healthy action, it restores the nutritive properties necessary for a healthy eye.

The manner in which I use this remedy is by brushing the eye-lids, eye-brows, and temples, with an eight grain solution of it, till a slight burning sensation is produced in the parts. I repeat the application every morning until the pain, blepharospasmus, and intolerance of light, are removed. Great caution is necessary in its application, not to let any of it get on the conjunctiva, for such an accident will produce great pain and do no good. If the use of it is found to produce twitching of the muscles of the face, it should be at once desisted from.

Now I must not be understood to say that I consider this remedy a cure for strumous ophthalmia, independent of every other treatment; far from it; nor do I say, that it, with other remedies, however well directed, will at all times cure the disease. But this much I hold to, that it is one of the most valuable adjuncts, with other remedies, in the treatment of strumous ophthalmia, that I have ever tried (and I have tried nearly all ever mentioned); and not in that disease only, but in all diseases of the eye caused by any disordered, or producing any disordered, state of the ophthalmic branch of the fifth pair of nerves—and they are many.

The applications that I use to the conjunctiva depend upon the severity, or rather the stage of the disease. If there is no ulceration, but only the phlyctenulæ and inflammation, the best local application is the saturated solution of the acetate of lead, which may be applied twice a day. If this is found to lose its good effects, the saturated solution of alum or of common salt, may be found to produce a good effect. The way the acetate of lead should be used is to make a saturated solution of it in water, and then filter it. If there is ulceration of the cornea the best application is the nitrate of silver, either in its purity or in solution; generally speaking, the ten grain solution will be found strong enough, and the weakest solution, from which any benefit can be expected, is the four grain. In children advanced in years, relief is often obtained from the application of the *vinum opii*.

The child's eyes should be bathed three or four times a day with the soothing lotion, and the edges of the lids smeared every night with the red, or some other stimulating ointment.

Mr. Mackenzie speaks highly of the application of stimulants to the conjunctiva; preferring the nitrate of silver, red precipitate salve, and the *vinum opii*, to any other.

The following is from the pen of Mr. Walker :—"Strumous ophthalmia, according to my experience, always more readily yields to the stimulant treatment, when properly employed, than it does to the antiphlogistic. I make this observation as definitely applicable and true whether the disease be in the acute or chronic stage; whether it be more or less intense, whether it be confined to the conjunctiva, or have extended to the cornea, or even to the sclerotic; the principle in all these cases is still the same, viz, the necessity to use stimulants. But the stimulants to be employed must be selected in accordance with the severity of the attack. If the attack be slight then the milder stimulants will be sufficient, such, for example, as the sulphate of zinc solution, and the zinc ointment; if somewhat more severe, the sulphate of copper solution, and the red precipitate ointment; if very active, the sulphate of copper in substance, or the nitrate of silver, either in solution, or ointment, or substance.

"In the treatment of this affection it often happens that the more powerful the application the better the success; while, on the other hand, the milder stimulants sometimes appear only to irritate, not to destroy the morbid action. In acute cases I should generally prefer the nitrate of silver pencil applied directly, but lightly, to the conjunctival surface; whereas in one of a less intense character I should probably use the sulphate of copper in substance, as well as some other stimulants before mentioned."

Dr. Tanesville speaks highly of the benefit to be derived from the use of creosote in strumous ophthalmia; I am sorry to say that my experience of it would not make me recommend it. The way he used it was by mixing ten or twenty drops of it in an ounce of mercurial ointment (when the case was protracted he even exceeded twenty drops); a small portion of this ointment was put by him, under the lids, and allowed to melt over the eye-ball; if it produced

violent smarting he bathed the eye with fresh water or cold milk* although I should not like to use the nitrate of silver in the same strength and as frequently as Dr. Desmarres of Paris, still I think the following extract from the Medical Gazette is worthy of notice. Dr. Desmarres after giving his theory, to prove that a weak solution of the nitrate of silver to the conjunctiva produces the same effects as the first action of cold water on our tissues, and then that the effects of caustic or strong astringents are similar to the effects of *intense* cold water on our tissues, he says, "In general I do not employ the nitrate of silver in a very weak form, for the reasons given, because the reaction is so much the more to be feared as we employ remedies less strong. It must not be supposed, however, that I administer it as a caustic, as the partisans of the ectrotic method recommend, for I have known that it is better always to preserve a proper medium between these two extremes. The reason of it is perhaps, in the first, that an eschar once formed removes the subjacent tissues from the action of the collyrium, and that nothing then hinders further the reaction from compromising all. We may judge of it, besides, by the swelling of the eye-lids, which in this case follows the application of the caustic. The strength of the collyrium which I employ varies from 40 to 90 centigrammes of crystallized nitrate of silver to 10 grammes of water, (these proportions reduced to English weights, are as follows; namely 7 to 15 grains of nitrate of silver to $2\frac{1}{2}$ drachms of water,) according as the photophobia is less or more; according also as it is more or less recent, as in inveterate scrofulous ophthalmic affections; for example, cases in which we act more vigorously at first. In this proportion the collyrium but seldom whitens the mucous membrane of the eye, (it, however, sometimes happens with the eyes of very young children, but then I take care to

* Medical Times for 1844.

diminish the strength of the nitrate of silver, recommending more frequent instillations). This done, the most important indication to attend to, is to prescribe to the patient repeated instillations into the eye, every half hour during twenty-four hours, without interruption. In some rare cases it is necessary to go on with the instillation every quarter of an hour during the first two or three hours of the treatment. I take care to forewarn the patient, that during these two or three hours he will experience considerable pain, because this is the usual period necessary for tolerance to become established; but that after that time the pain will become very supportable, and will be followed by evident amelioration, which is invariably the case. In this manner the diseased eye is not liable to reaction, because the force of re-percussion acting in a continual manner, maintains the vessels in a state of contraction, which this reaction is unable to overcome. If I can see the patient five or six hours after the instillation of the first drop, I judge by the state of the organ whether or not the reaction tends to supervene, and then if not I continue; and if it do, on the contrary, I increase the collyrium, one and a half, two, or three grains of the nitrate of silver. If I cannot see the patient until after twenty-four hours, I prescribe immediately a collyrium a little stronger, and I have nothing to fear. In some cases in which I cannot trust to the perseverance or the good will of the patient, I recommend fomentations of iced water to assist the action of the collyrium. However, I ought to say that this has but seldom occurred to me, in more than sixty cases. After twenty-four hours, reaction does not supervene, but the intolerance of light is not always subdued completely, although the external tunics of the eye are usually diminished; and, in this case, as in the other, I increase the strength of the collyrium, and after forty-eight hours, rarely more, the ophthalmia is in its second stage, I mean the acute form no longer exists. Then the instilla-

tions are repeated less often every hour, and at length discontinued, and replaced by a general appropriate treatment."

Dr. Hocker, of London, recommended having the lids blackened, by rubbing over them the nitrate of silver in substance: his object in this treatment was to remove the great susceptibility of the ophthalmic branch of the fifth pair of nerves, and thereby relieve the intolerance of light, lachrymation, and blepharospasmus; he considered the treatment would finally result in the cure of the disease. He gives the case of a boy who had strumous ophthalmia of one eye and was cured by this treatment, but in one week after got purulent ophthalmia of the other eye, which he states to have cured, with the same treatment, applying the caustic but twice, a week intervening between the first and second application.*

Before I discovered the benefit to be derived from the use of veratria in strumous ophthalmia, I constantly made use of the nitrate of silver in the manner recommended by Dr. Hocker, and generally speaking with good results, but I never depended upon it as a means of cure. I could never think of treating such a formidable disease, as purulent ophthalmia, in such a trifling manner.

Dr. Furnivall, of Hertford, considered the tincture of iodine brushed over the lids equally as good as the nitrate of silver; I have not found it so. Dr. Jacob recommends the use of blisters in strumous ophthalmia; he says, "Blistering, which may be resorted to in any of the preceding forms of inflammation, appears particularly serviceable here, and should be repeated as often as they heal, either on the temples, at some distance from the eye, or behind the ears."

I have always found that blistering in strumous ophthalmia did more harm than good. In the London *Lancet* for 1847, Mr. Morand draws the attention of the profession to

* *Lancet*, November, 1842.

the state of the Schneiderian membrane in this disease, and says:—"In scrofulous ophthalmia, the olfactory membrane participates with the conjunctiva in the inflammation that is set up; that it is especially about the turbinated bones, and in the anfractuositics of the nasal fossæ, that the inflammatory action resides; and this shows itself in the form of an œdematous engorgement, precisely similar to what is observed in the eye-lids. The more I study this disease, the more convinced am I that this is the case. A little attention suffices to show that the redness and tumefactions of the pituitary, almost always precede or accompany that of the conjunctiva. This can be more positively determined by means of the speculum auris. On examining attentively the interior of the nasal fossæ, one cannot fail to observe that the redness and swelling of the nostrils, and even of the upper part of the lip, that are so commonly observed in persons of a scrofulous habit, are merely an evidence of the inflammatory action going on in that membrane. It is by proceeding in this way that we can best appreciate the degree and extent of this inflammatory action, the extension of which, to the palpebral and ocular mucous surfaces is often very rapid; sometimes, however, it remains for a long time stationary, without showing any disposition to extend." To relieve this inflamed state of the pituitary membrane, Mr. Morand recommends the application of the nitrate of silver, either in ointment, lotion, or substance.

This extract I not only consider valuable in a practical point of view, but also in proving, that my theory of strumous ophthalmia, with reference to the ophthalmic branch of the fifth pair of nerves, is amply proved by it.

Pustular Ophthalmia.—Although pustular ophthalmia may be found in persons in whom no strumous affection can be traced, yet it can hardly be considered anything more than a variety of the disease; however, the subjects of it, generally

speaking, are those who pass the age for strumous ophthalmia, viz:—persons from twelve to twenty-five or thirty years old. It is not so dangerous a disease as strumous ophthalmia, neither is there the same intolerance of light; blepharospasmus is of very rare occurrence; and it is found to yield more readily to well directed treatment.

Although the pustules vary in situation, yet they are always on the sclerotica, never on the cornea, but generally close and inferior to it. They also vary in size and number; are very little elevated, of a yellowish cast, although, when they burst, they discharge a fluid that is more of a watery than purulent character.

The ulcer left by the bursting of a pustule generally forms a groove between the cornea and sclerotica, and although it does not spread, it will sometimes penetrate into the anterior chamber of the eye, which may be followed by prolapsus of the iris.

Treatment.—The best treatment is that recommended for strumous ophthalmia. Unless an ulcer is formed, I have rarely found it necessary to use a stronger stimulant than the ten grain solution of the nitrate of silver.

Ophthalmia From Eruptive Fevers.—By this term is meant such inflammations of the conjunctiva as are found accompanying, or the result of, scarlet fever, small pox, measles, or erysipelas.

The ophthalmia which accompanies scarlet fever and measles, is called ophthalmia scarlatinosa, and morbillosa; although the disease, in both cases, may be nothing more nor less than simple catarrhal ophthalmia, which very generally disappears as the fever gets well; but if it does not, it must be treated as simple inflammation of the conjunctiva, for if allowed to go on, it will assume a chronic form, and is likely, after continuing for years, to terminate in an incurable ophthalmia tarsi.

When the inflammation assumes a chronic form several vessels, of a bluish-red color, will be seen to traverse the white of the eye: the palpebral conjunctiva of the lower lid will be of a dusky-red color; the lids will be glued together in the morning when the patient awakes; and after some time the sight becomes very weak, which is first discovered by the patient when reading by artificial light.

The treatment I find best for such cases is to introduce between the lids every night a small portion of the red ointment, or if the case is severe, Jannin's ophthalmic ointment, without dilution, and have the eyes bathed three or four times a day with the soothing lotion. The best constitutional treatment is to give small doses of quinine and tartarised antimony.

Any of these inflammations may become modified by a strumous diathesis: if so, it must then be treated on the principles laid down in strumous ophthalmia.

Ophthalmia Variolosa.—This is not the disease arising from simple conjunctivitis accompanying small pox; but it arises from an eruptive inflammation of the integuments, spreading to the conjunctiva, and producing similar pustules on the conjunctiva, to those first formed on the integuments.

Formerly, in consequence of the frequency of small pox, many people lost their sight, by either partial or total staphyloma, as the result of this formidable disease. The pustules may form on any part of the conjunctiva, but they are generally found on the cornea. When they first appear they form small white points, which gradually become yellow and elevated; these in time burst, leaving ulcers of a sloughy character, which often destroy the whole cornea, and frequently penetrate into the anterior chamber of the eye, producing a loss of the aqueous humour, and prolapsus of the iris. A very frequent result of this disease, is, ophthalmia tarsi, with obstruction of the nasal duct, which, as a matter of course, produces stillicidium lachrymarium.

From the commencement of ophthalmia variolosa, the lids are swollen with the inflammation and pustules, sometimes indeed so much so as to render it impossible to examine the cornea. If the purulent matter is not kept washed off the lids, they will be adherent together, but the practitioner must bear in mind that though the lids be swollen and adherent together, yet the conjunctiva may be perfectly free from inflammation and pustules.

Authors have described secondary variolous ophthalmia, as occurring when the small pox has either subsided, or entirely disappeared; it is said to be much less violent than when it occurs during the virulence of the disease, although it sometimes does go on to the destruction of the cornea; but that this rarely happens unless there is a high degree of secondary fever.

I have never seen a case of secondary variolous ophthalmia, but I have seen the primary, modified by a scrofulous diathesis.

Treatment.—If there were no pustules on the conjunctiva, I would treat the case as simple conjunctivitis, but if there were pustules, I would open them with a cataract needle, and afterwards touch them with the solid nitrate of silver once every day, as long as the ulcer continued to slough, or spread; but when it ceased so to do, I would substitute the four or six grain solution for the solid nitrate of silver.

During the disease the eyes should be kept perfectly clean, by means of a soft sponge and warm water; and the lids prevented from adhering together at night, by having them smeared, at bed time, with some stimulating ointment, such as Jannin's ophthalmic, the red, or the red precipitate.

Some recommend blood-letting and general antiphlogistic treatment. I prefer the tonic plan, that is quinine, or the infusion of colomba acidulated with nitric acid.

When variolous ophthalmia is modified by a strumous diathesis, I treat it on the same principle as strumous ophthalmia.

Erysipelatous Ophthalmia.—It frequently occurs that erysipelatous inflammation of the head and face, extends to the conjunctiva ; but idiopathic erysipelatous conjunctivitis, is a disease very seldom met with ; it does sometimes, however, take place, and may be produced by any of the causes which excite simple inflammation of the conjunctiva. Why injury, cold, &c., will produce simple conjunctivitis in one person, and erysipelatous in another, is not more easily explained, than that from the same causes simple inflammation will be produced in the integuments of one, and erysipelatous in another person. All that can be said in explanation is, that there is some predisposing cause existing in some persons, that is not in others, when if they only receive the slightest injury erysipelatous inflammation is sure to follow.

Symptoms.—The symptoms of this disease, are, an increased vascularity of the conjunctiva, but the color is of a much paler red than in any other form of inflammation. This vascularity is soon followed by watery effusion into the sub-conjunctival cellular tissue, causing the conjunctiva to become so elevated, as to overlap the edge of the cornea, and even, sometimes, to protrude between the lids ; this swelling resembles chemosis in every respect, except in not being so vascular. The pain is generally very slight and of a prickly nature. Intolerance of light, and lachrymation, are seldom complained of, except when the disease is very severe, and even then these symptoms are not very bad. The secretions from the conjunctiva and meibomian glands become increased, and altered in character, so that the lids are glued together when the patient awakes in the morning. If the case be mild, the conjunctiva, instead of swelling in the manner just described, merely forms yellowish vesicles around the edge of the cornea.

When the disease goes on favorably the symptoms subside, the secretions of the eye gradually assume their natu-

ral appearance, the swelling abates, but for a long time the conjunctiva does not assume its natural color.

Treatment.—The best general treatment, is, first to give an emetic and purgative ; and, in about twenty-four hours after, tonics may be administered.

The local treatment must be particularly attended to. As a general rule, the ten grain solution of nitrate of silver will be a sufficiently strong stimulant; but when the inflammation is very severe, the twenty grain solution may be applied. The patient should bathe his eyes two or three times a day with the soothing lotion, or the eight grain solution of alum, and smear the edges of the lids, at night, with some stimulating ointment.

When the conjunctiva is greatly swollen, benefit is derived from opening it with either a lancet or cataract knife. Some authors recommend depletion, but it is a treatment I should never think of adopting.

Corneitis, or Keratitis.—In treating of inflammation of the conjunctiva, it has been constantly mentioned how these inflammations spread to the cornea, producing ulcer, abscess, slough, and even total destruction of the cornea ; to such cases, however, the term corneitis is never applied, it being only applicable when the inflammation originates in the substance of the cornea : instances of the disease are very rare, yet they sometimes do occur, and so generally is the inflammation found modified, by a strumous diathesis, that some authors seem to consider inflammation of the cornea a scrofulous disease ; indeed, Mr. Mackenzie calls the disease scrofulous corneitis ; this, however, is an error, for inflammation of the cornea may occur in any person, whether of a scrofulous constitution, or otherwise. Inflammation of the cornea is generally very slow in its progress, and difficult to diagnose, even in the early stage, but yet more so in the advanced stage, from its being then combined with inflammation of the conjunctiva. The first observable

symptoms, are, the cornea losing its transparency, and becoming dull and hazy ; objects will then appear to the patient, as if he saw them through a fog, or a piece of muddy glass. Sometimes the whole of the cornea will present a hazy appearance, in other cases there will be only a part of it dull. When the inflammation is in the superficial laminae, the opacity is of a light bluish cast, but when deep seated, it is of a milky hue. At the commencement of the disease the pain is not severe ; but there is some slight intolerance of light, and an increase of tears ; as the inflammation advances, red vessels are seen on the cornea, which soon form a vascular net-work over its whole surface, sometimes so thick and red, as to make the cornea appear as if it were covered with a piece of red cloth ; to this appearance the term *pannus* is given : the vascularity of the sclerotic and conjunctiva, is also increased, but particularly of the former, the vessels of which show their radiated appearance round the edge of the cornea. As the disease advances, there is great pain, profuse lachrymation, and intolerance of light, although such is the opaque state of the cornea, that not one ray of light can reach the retina. It is rare to have both eyes affected at the same time, yet it does occasionally occur ; it is, however, by no means uncommon to have the second eye affected after the one first inflamed gets well. When the inflammation is modified by a strumous diathesis, instead of the above primary symptoms, the surface of the cornea will be usually found covered with very minute ulcers, forming little depressions on it.

The best termination to corneitis is resolution ; it may terminate, however, by matter collecting between the layers of the cornea, forming what is termed an *onyx* or *unguis*, but correctly speaking, is an abscess of the cornea. This matter may be absorbed, but if not, it will either burst on the front of the cornea, leaving an ulcer, or on the posterior part of the cornea, leaving an ulcer there, the matter falling into the aqueous humour, and forming a false *hyppopium*.

The case may end in ulceration of the cornea, without the formation of the deep seated matter. If the inflammation be modified by a strumous diathesis, it is after ulceration has taken place, that we find it well marked, the ulcers becoming deep, and having ragged edges.

We sometimes find conical cornea resulting from corneitis, produced by an increase of the aqueous humour ; this state of the eye is generally accompanied with partial amaurosis.

Albugo, or a deposition of lymph between the layers of the cornea, is not an unfrequent result of corneitis. The same causes, cold, wounds, over exertion of the eyes, &c., which produce inflammation in other parts of the eye, will act in producing inflammation of the cornea.

Treatment.—In the treatment of this disease much depends upon the state of the constitution; if the patient be of a full strong healthy habit, bleeding, with other antiphlogistic means, will be found serviceable, particularly if the acute stage be very severe. However, such cases are of rare occurrence, indeed, generally speaking, such are the subjects in which corneitis is found, that much more harm than good would be experienced from bleeding.

There is hardly a week, nay a day, that I have not some case of wound of the cornea, and rarely an instance where it produces corneitis, except in persons of an unhealthy constitution. In general the treatment that I find to answer best, is quinine internally ; if, however, I find, on seeing the case, that abscess has formed, I combine with the quinine, calomel, but this last I never give in such a quantity as to make the mouth sore, my object being simply to promote the absorption of the matter ; this being accomplished I discontinue the calomel, and continue the quinine, till a cure is perfected ; but if the quinine should lose its effects, I discontinue it, giving in its stead the ioduretted iodide of potassium, I have also found some good effects from the use of turpentine. When there is abscess or ulcer of the cornea or

even inflammation of the conjunctiva present, local stimulants should be employed, and perhaps the one that will agree best, is the eight, or ten, grain solution of the nitrate of silver. In all cases, brushing the eye-brows and lids with the solution of veratria will be found of great benefit ; but should the inflammation spread to the iris, the pupil must be kept dilated with atrophine, or some preparation of belladonna.

Sclerotitis.—By this term is understood inflammation of the sclerotic coat of the eye, whether it spreads from it to other parts or not. Mr. Mackenzie gives to it the name of rheumatic ophthalmia, but as he gives no good reason for adopting such a name, I conceive it only leads to confusion, as we should be very likely to suppose from the term, that it in some degree resembled rheumatic inflammation in other parts, or at least that it only occurred in persons who were at the time, or had been previously, suffering from rheumatism. Now such is not by any means the case, for the disease is found just as often in those who have not, as in those who have, suffered from rheumatism.

It is rare to find the inflammation confined to the sclerotic ; indeed when patients present themselves to the practitioner, the sclerotitis is generally found combined with either conjunctivitis, or iritis, or some other part of the eye is inflamed. Nor is this much to be wondered at, when it is remembered how rapidly this inflammation spreads. True idiopathic sclerotitis, is most generally found in persons of middle age, whereas that disease, combined with conjunctivitis, is generally in persons of advanced years. When the inflammation spreads to the conjunctiva, Mr. Mackenzie gives it the name of catarrho-rheumatic ophthalmia ; and when it spreads to the iris it is called sclero-iritis. I see no possible use for the first division ; indeed I rather think it only tends to confusion.

Symptoms.—While the inflammation is confined to the sclerotic, the chief local symptoms to be observed, are a

bright redness over the eye, the vessels of the sclerotic becoming of a pale pink color, radiating, or forming a zone, round the margin of the cornea. If the sclerotic conjunctiva be moved with the finger, it will be observed that it moves over the vessels, not with, as in conjunctivitis. The pain is chiefly circumorbital and confined to the course of the ophthalmic branch of the fifth pair of nerves; consequently there is contraction of the pupil, intolerance of light, and profuse lachrymation. There is none of that gravelly feeling in the eye which accompanies conjunctivitis; but there is dullness of the cornea, which, with the contracted pupil, causes dimness of vision. Although the pain does not subside altogether, yet it is much less severe, in the early part of the day, becoming worse towards evening, and continuing to increase in violence till about mid-night; towards morning, it begins to abate again; these exacerbations, however, do not of necessity occur every night; I have seen cases when they occurred only every second or fourth night, and the most obstinate case I ever saw, I have had very lately under treatment, where the great pain only came on every ten days.

These are the local symptoms in pure idiopathic scleritis: but, as has been already stated, the inflammation may spread to the conjunctiva, the cornea, the iris, or in fact to every part of the eye. That it should spread very rapidly to the iris is not much to be wondered at, when it is remembered, that the very vessels which are so distended with blood upon the sclerotic, terminate upon the iris. When the inflammation spreads to any of these parts, there is an increase of the symptoms already described, in addition to new ones. If the conjunctiva is inflamed, of course there are symptoms not only of scleritis, but also of conjunctivitis, equally so if it spreads to the cornea or iris. When once the conjunctiva is inflamed, there is no longer the pink zone, nor white line to be seen round the cornea, both being

hid by the inflamed conjunctiva; and at this stage there may be œdema of the subconjunctival cellular tissue, accompanied with swelling of the eye-lids, which never happens so long as the inflammation is confined to the sclerotica.

When sclerotitis occurs in old persons, the inflammation extends to other parts much more rapidly, than in persons of middle age; why this should be the case I have never seen or heard explained. My idea is, that the inflammation is modified in old age by the nutritive properties of the eye becoming weakened, as it is modified in children by scrofula; certainly, the termination of conjunctival inflammation in both cases is very similar.

Constitutional Symptoms.—There are generally symptomatic fever, want of sleep, tongue furred, pulse hard and frequent, skin hot and dry, and the bowels generally confined.

Causes.—The exciting causes which produce inflammation of the sclerotica, are the same as those which produce inflammation of the conjunctiva or cornea, viz:—cold, injuries, &c. It is very difficult to say, what are the predisposing causes, indeed, all that can be said is, that in some constitutions the fibrous membranes are more liable to inflame, than the mucous, and *vice versâ*; and we find that this predisposition in fibrous membranes to become inflamed, increases as people advance in life, which may have led Mr. Mackenzie to give this disease the name of rheumatic ophthalmia.

Treatment.—Bleeding has been strongly recommended in the acute stage of this disease, both by Mr. Mackenzie and Mr. Walker; and their opinion is, that the more the inflammation tends to spread to other parts, the greater the necessity for both local and general depletion. How Mr. Mackenzie, after drawing so great a distinction between rheumatic, and catarrho-rheumatic, ophthalmia, could recommend depletion in both forms, I cannot understand; particularly after stating, that the latter disease was more fre-

quent in old people. I have found that bleeding, even strong plethoric people, in this disease, was followed by so great a reaction, as to increase the inflammation. Indeed, every day's experience convinces me, fully, how little benefit is to be derived from depletion in disease of the eye,—of course I speak as of a general rule.

My treatment is first to give a good purgative, and, if I find no particular objection, the medicine I choose is a drop, or half a drop, of croton oil, for it not only acts as the most active purgative, but specifically by relieving the pain of the ophthalmic branch of the fifth pair of nerves. That croton oil acts as a specific, in neuralgic affections, is fully established.

I then give calomel, combined with quinine and opium, every four or six hours, according to the severity of the symptoms, till there is a decided check to the inflammation. If possible, I avoid producing ptyalism, particularly if the patient has a bad constitution. As soon as I stop the calomel, I either continue the quinine, or substitute for it the ioduretted iodide of potassium. During this treatment, I always attend to the secretions of the skin and kidneys; I therefore give an occasional dose either of Dover's powder, or of benzoic acid, at bed time, ordering the patient at the same time to have a mustard pediluvium.

Rest of mind, body, and eyes, being very necessary, I always order my patient to be confined to the house for a few days, and allowed pleasant society. I do not keep the patient on antiphlogistic regimen, but I restrict his diet, allowing him broths, jellies, rice, bread, light pudding, and even a little fish, or broiled fresh meat, occasionally. I have found great benefit from dry-cupping the nape of the neck, and behind the ears, and in the chronic form, from blisters to these parts, provided the patient be not old or debilitated, in which case they always do injury. When the case is chronic, I find the greatest benefit from keeping

the eye-lids, and round the upper part of the orbit, smeared with the tincture of iodine; but, whether acute or chronic, I always keep the pupil under the influence of belladonna, either by dropping the solution of atrophine upon the conjunctiva, or smearing behind the ears with the extract of belladonna.

So long as the inflammation is confined to the sclerotica there is not much use in any application to the eye; if, however, the patient finds that either a warm or cold cloth applied to the eye gives relief, there can be no objection to either; generally I have found the warm to be the more comfortable.

If the inflammation spreads to the conjunctiva, the eight or ten grain solution of the nitrate of silver may be applied to it once or twice a day, and the eye bathed, occasionally, with some of the soothing lotion, it being first made tepid.*

Choroiditis.—The choroid being the vascular coat of the eye, there is every reason to suppose that it would become

* In the British American Journal of Medical and Physical Science for November, 1849, there is an interesting and valuable communication, on the treatment of sclerotitis, and sclero-iritis by hydriodate of potash, by Dr. Macdonell of this city, the careful perusal of which I would recommend to all who have an opportunity of reading this valuable Journal, which has done so much for the medical profession in Canada. The author of the above mentioned paper shows from his own experience, and mine, what a valuable remedy, in these inflammations of the eye, is hydriodate of potash, when given in large and repeated doses. I have only to repeat here, what I have already stated to him, that having used it, at his suggestion, in acute sclerotitis, I have found it a most valuable remedy, and I have rarely found it to fail in chronic cases. Indeed, since the publication of his paper, I rarely think of using any other remedy in any case of sclerotitis.

The dose that he recommends is, from eight to fifteen grains, three times a day.

There is a note on the paper alluded to by Dr. Macdonell, in which he brings forward a most interesting theory, and one which I am inclined to subscribe to. It is on the subject of hypopium. He considers that if a hypopium be absorbed, it is not pus that has been in the chamber of the eye, indeed, that a hypopium is never purulent matter, except it be what is termed a false hypopium. He reasons from analogy, and says, that no matter in what part of the body pus is formed it is never absorbed; in fact that pus globules are too large to be taken up by the absorbents. This is a subject of the greatest practical importance, and deserving of the investigation of every Pathologist.

the seat of inflammation, and no doubt such is frequently the case; nevertheless, in consequence of its situation, it is very difficult to diagnose. To find inflammation of the choroid combined with a similar state of the retina, iris, or sclerotica, is by no means uncommon, but I am free to confess that I never saw a case yet, that I could pronounce true idiopathic choroiditis, without inflammation of any of the other tunics. Indeed, from the situation of this tunic, it is scarcely possible to suppose it could be inflamed and none of the other tunics partake of the inflammation. There seems to be some difference of opinion amongst authors as to what consequences are likely to ensue from choroiditis. Mr. Mackenzie supposes that it produces staphyloma choroidalis, by the pressure of the choroid coat on the sclerotic, causing the latter tunic to be absorbed in a more or less degree, and then, for want of strength, yield to the pressure from within.

The tumor thus formed, Mr. Walker calls staphyloma sclerotica, and says it may occur without inflammation of the choroid. There is one thing certain, namely, that if inflammation of the choroid extends to the retina, we may expect equally bad, if not worse results than any that can arise from pure idiopathic retinitis; and if it spreads to the iris or sclerotica, surely the same evils may follow as if the inflammation had commenced in either of these parts; so that all, or any, of the sequelæ of iritis, sclerotitis, and retinitis, may follow choroiditis. But should the inflammation not spread from the choroid, I can very well imagine how pressure, from the swollen membrane, on the retina, may produce partial or total amaurosis, and also how by its pressure on the sclerotic, it would cause a bulging out of that tunic, from either absorption or attenuation.

Symptoms.—In addition to the symptoms that are present in all cases of internal ophthalmia, I have always remarked that when the choroid is inflamed, in connection with some

of the other tunics, there is also a peculiar bluish appearance of the white of the eye, as if the sclerotica had become transparent, permitting the choroid to be seen through it ; but I have never met with an instance in which the symptoms present would convince me, that the case I had to treat was pure idiopathic choroiditis. The following are some of the symptoms given by Mr. Mackenzie ; speaking of the redness he says :—“ One or more of the recto-muscular arteries are enlarged, and running towards the edge of the cornea, are seen to end there in a broad lash of small vessels. There is scarcely ever any general redness over the eye-ball, or *much* inflammation of the conjunctiva. The portion of the sclerotica subjacent to the enlarged vessels, frequently presents in the early stage of the disease a thickened and fleshy appearance. The conjunctiva also appears thickened. It is probable that, even in the early stage, a preternatural adhesion takes place between the sclerotica and the choroid.”

Now the reader will at once perceive that so far as the symptom of redness is concerned, it is not even pretended by Mr. Mackenzie, that it occurs in pure idiopathic choroiditis, or when the inflammation is confined to the choroid coat, for, be it remarked, he says there is an alteration in the conjunctiva, and even that there is probably a preternatural adhesion between the choroid and the sclerotica. The other symptoms, that he gives, are discoloration of the sclerotica and iris, the pupil becoming displaced and filled with lymph,—exophthalmos and exophthalmia, intolerance of light, and epiphora. As all these symptoms, however, are found in other forms of ophthalmia, they are not distinguishing marks of inflammation of the choroid. He makes the following remarks on pain and vision :

“ *Pain.*—This varies much in different individuals. When there is as yet no protrusion, the pain is moderate ; when the sclerotic is much pressed and distended, and especially

when this takes place suddenly, and is attended with considerable increase of redness, the pain in the eye becomes severe, and sometimes furious. Hemicrania is also present, affecting principally the top of the head, the high part of the temple, and the cheek. It is not strictly circumorbital, nor is it strikingly nocturnal." "Vision is variously affected in choroiditis, for in some instances the very first symptom complained of, is dimness of sight. The patient generally complains of photopsia, and not unfrequently of iridescent vision. Hemiopia, all objects to one or other side of a perpendicular line, or above or below a horizontal line, appearing dim, all objects appearing confusedly and as if double even when viewed with one eye, are symptoms which not unfrequently distress the patient long before the redness or blueness of the eye attracts attention. If the disease goes on we sometimes find that total blindness ensues, even when the choroid appears but partially affected; while in other cases the whole eye-ball is evidently enlarged and discolored and yet a considerable degree of vision is retained."—"Various degrees of febrile excitement attend choroiditis. In the early stage before distension brings on acute pain, the pulse is not affected; after the patient has suffered much, a cachectic state is apt to follow with quick pulse, pale or sallow complexion, excessive nervous irritability, and great general weakness. The patient is inactive, complains of coldness of the extremities, and evidently labors under a deficient cutaneous circulation. The digestive organs are frequently much deranged, even from the very first. Want of appetite, frequent acidity of the stomach, costiveness, flatulency, and foul tongue, attend the disease in many instances."

No matter what difference of opinion may exist amongst authors as the diagnostic signs of choroiditis, there is one thing evident, that it presents all the appearances of severe internal ophthalmia, the consequences of which are very

dangerous to vision. The subjects of the disease are generally adults or adolescence of a debilitated constitution ; it is more frequently found in females than in males. The same exciting causes which produce inflammation of any other part of the eye, will no doubt act in producing inflammation of this tunic.

Treatment.— Mr. Mackenzie and Mr. Walker both agree that to subdue this inflammation, dependence is to be placed chiefly in blood-letting, purging, and all other antiphlogistic remedies. I cannot conceive how Mr. Mackenzie can speak so highly of such debilitating treatment, after giving such an array of constitutional symptoms. Who would be justified in bleeding a man with a sallow complexion, excessive nervous irritability, great general weakness, coldness of the extremities, and deficiency of cutaneous circulation ? Mr. Walker speaks highly of the good effects of mercury ; both he and Mr. Mackenzie agree as to the good effect of belladonna and counter-irritation.

It must be remembered that I never saw a case where some other tunic was not implicated, as well as the choroid, and in none of these could I recommend bleeding. I always at first give a gentle aperient, or purgative, and afterwards one of the following pills, until the breath is effected slightly by the mercury. Calomel, six grains, sulphate of quinine, twelve grains, extract of hyoscyamus, six grains. These are to be mixed, and made into a mass, then divided into twelve pills, one of which may be taken every six hours till the above mentioned effects are produced. When I discontinue the pills, I give the quinine, or ioduretted iodide of potassium mixture ; and during this treatment I keep the pupil under the influence of belladonna, and the eye-lids and eye-brows smeared with the tincture of iodine. When the case becomes chronic I always blister the nape of the neck ; and if the cornea or conjunctiva be inflamed I drop on the eye every day the six or eight grain solution of the

nitrate of silver. If in the chronic stage there is a tendency to choroid staphyloma, Mr. Mackenzie recommends the operation of paracentesis oculi. He operates with a broad cataract needle, by pushing it into the eye in the direction of the vitreous humour, making the puncture in the sclerotic, and penetrating inwards about the eighth of an inch: this treatment he repeats every eight or ten days according to the state of the eye.

I cannot speak of this treatment from experience, but I would not hesitate to try it when every other had failed.*

Retinitis.—The reader will do well to bear in mind that the only use of the retina is to receive the impression of external objects; in fact, that it is insensible to everything except these impressions. It must also be remembered that this tunic, like every other body, reflects light from itself, but from its situation it is impossible to draw the distinction between the light reflected from it and that from the hyaloid membrane or even the vitreous humour. The following is from the pen of Wm. Cumming, Esq., late surgeon to the London Hospital. It is on the luminous appearance of the human eye, and its application to the detection of disease of the retina:—"The author mentions the well known luminous appearance of the eyes of cats, dogs, and other animals, the reflection from the eyes of Albinos, &c., and after quoting from the works of Muller, Beer, and Tyrrell, as to the other cases in which reflections have been observed from the posterior part of the human eye, proceeds to say, that the object of the present paper is to show, that the healthy human eye is equally, or nearly equally, as luminous, as the eye of a cat, &c., when observed under favorable circumstances; and the application of the alteration, or loss of this luminous apparatus, to the detection of changes in the

* Since the above was written I have met with an article from the pen of Dr. Jacob, in the Dublin Medical Press, in which he condemns the practice of bleeding.

retina, and posterior part of the eye. The author states that the reflection may be seen in the following manner: Let the person whose eye is to be examined, be placed at the distance of ten or twelve feet from a gas or other bright light; the rays of light must fall directly on the face, and all rays falling laterally on the head must be intercepted by screens placed half way between the light and the eye examined. If the reflection be bright it will at once be seen from any spot between the light and the screen. The author having more particularly described the mode in which the observations brought forward in this paper were made, remarks: 'The luminous appearance varies from a dingy red, to a bright silver or golden tint, in some cases of extreme lustre, equalling that of a well ignited coal. It is more brilliant when seen at several feet distant. It was always seen when the eye was healthy, and the pupil easily dilated. The reflection was seen in cases in which the lens had been removed by the operation of solution. Twenty cases were examined indiscriminately, vision being perfect in all; the age varying from a few months to sixty years. In sixteen cases the reflection was bright and very evident, in four faint, and seen with more difficulty, and in one it was not seen. As to the cause of this reflection, it is attempted to be shown that the retina, although a perfectly transparent medium in the living eye, is still a reflecting body. The formation of images upon the retina, the reflection from the cornea and lens, and other transparent bodies, are cited as proof of this; other circumstances would increase the brilliancy of retinal reflection, viz:—the concave shape of the retina itself, the position of the lens, the influence of the vascular anterior layer of the retina filled with red globules of blood.'

"The author remarks, that the establishment of the fact of a similar reflection from the healthy human eye, to that from the eyes of other animals, appears important in two

ways. First, as a physiological fact, it shows that too much influence has been ascribed to the tapetum, that of the retina having been entirely overlooked. Secondly, in a pathological view the existence of this appearance in the healthy eye having been recognised, its non-existence or alteration may enable us to detect changes in the condition of the retina and posterior part of the eye, heretofore unknown, or satisfactorily to see those which we only expected.”*

Notwithstanding this very beautiful theory of Mr. Cummings, I by no means consider his arguments to be conclusive evidence, that this luminous appearance is from the retina, any more than that it is from the hyaloid membrane or vitreous humour. But even granting that such an appearance is from the retina, its non-appearance can be no certain proof of a change in that tunic, as a disordered state of any of the humours, capsule of the lens, or the hyaloid membrane, would certainly obstruct the reflected light, even though the retina be in the most healthy condition.

That the retina is often the seat of inflammation there can be no doubt, and this inflammation may be either acute or chronic; the acute may become chronic, but there can be chronic inflammation of it without its being acute; indeed this is the inflammation to which the retina is most liable. When the retina becomes the seat of violent acute inflammation, it soon spreads to the whole of the internal tunics of the eye, forming the ophthalmia interna idiopathica of Beer, which, if not checked, very soon runs into suppuration producing destruction of the whole eye-ball.

Symptoms.—It can be well imagined that from the very earliest stage of this disease, vision must be more or less affected, and as the inflammation increases, so does vision diminish, till it is finally lost. From its very close connection with the hyaloid membrane, and anterior capsule of the lens, these parts soon partake of the inflammation, all of

* Dublin Medical Press.

which becoming swollen, press upon other sensitive parts, and consequently producing great pain, and a feeling of pressure, and tension of the whole eye-ball. There is great circumorbital pain; indeed the pain extends along the whole course of the ophthalmic branch of the fifth; the pupil contracts and loses its black appearance, and if the inflammation spreads into the iris, the pupil may become permanently closed. Even should the inflammation subside, it may leave the retina so thickened, and adherent to other parts, as not only itself to be completely disorganized, but by its pressure on the ciliary nerves, cause paralysis of the circular fibres of the iris, and consequent dilated and fixed pupil. But it is possible even for the inflammation to spread to all the tunics, and afterwards be subdued, without any evil results beyond slight dimness of vision, which will disappear in a great degree with time and proper treatment.

From the beginning of the attack there is great intolerance of light, the inflamed tunic not being able to endure that, which is necessary for the functions of the eye in a healthy state: there is also profuse lachrymation.

Impaired vision, and a disordered state of the functions of the retina, is indicated by the patient complaining of red flashes of light darting through the eye, and sometimes lights of various hues, like the rainbow; these false lights are sometimes circular, with a black spot in the centre, such as can be produced by pressing on the superior and internal angle of the eye-ball with the finger; indeed, these fiery spectra often continue after sight is completely gone, giving to the patient the false impression of seeing.

When the iris becomes attacked in the general inflammation, besides losing its natural color, it is pushed forward towards the cornea, and the pupil, if not entirely closed, presents a reddish grey color, caused by the inflamed state of the humours behind it, and the lymph, which is generally, at this time, deposited on the retina. The sclerotic coat is

also red, and even though the cornea should not partake of the inflammation, it becomes muddy from the pressure upon it from within. While this dreadful degree of inflammation is going on, the patient's suffering is excruciating, the pain in the head producing the most severe sympathetic fever, causing him at periods to rave,—until either the eye is lost by suppuration, or the inflammation is arrested, leaving the retina insensible, the pupil closed, and finally the eye-ball atrophied.

The suppurative stage is generally ushered in by a severe shivering fit, the eye feels to the patient cold and heavy, the pain not so constant but at times very severe. The pus is seen to collect in the anterior chamber of the eye, lying at first in a small quantity at the bottom of it, but as it increases, gradually rising up, and not only hiding the pupil but sometimes the whole iris, by its filling up the anterior chamber. The matter thus pressing on the cornea causes it to project, and sometimes to burst.

Cases have occurred where the matter escaped through the sclerotica, but whether it escapes through the cornea or sclerotica the result is the same; the pain gradually subsides and the eye collapses.

These are the general symptoms and termination of acute retinitis, when it runs into general ophthalmitis: but, as has been already stated, the inflammation must not necessarily so terminate, for it may be subdued, or it may from some cause put on the chronic form.

Causes.—It is sometimes impossible to discover any cause for acute retinitis; but generally speaking, it is produced by a greater quantity of strong light falling on the retina than it is prepared to receive, such as happens when a person, with the pupil widely dilated in the dark, rushes suddenly into a room brilliantly illuminated. The same thing occurs from flashes of lightning, or from examining very minute objects which reflect a strong light.

Treatment.—Perhaps there is not a disease of the eye in which blood-letting can be resorted to with such decided advantage, as in acute retinitis: but that real benefit may be derived from this treatment, it must be adopted at the very commencement of the attack, for when once lymph is deposited upon the retina, very little benefit will be derived from it. As to the quantity of blood that should be taken, at a time, or the number of times it should be taken, it will altogether depend upon the violence of the symptoms, and the patient's general constitution; but the first bleeding should produce a decided diminution in the vascular system, and, generally speaking, it will be well to bleed *ad deliquium*; such a bleeding at first may prevent the necessity of two or three after bleedings, and all that may then be required will be cupping and leeching. After the bleeding the patient should get a good purgative, the best perhaps being a dose of croton oil. After the bowels have been well acted upon, the sooner the patient is put under the influence of mercury the better, and to attain this object one grain of calomel with a quarter of a grain of opium, should be given every three or four hours, until the system is affected. If the opium should be found to disagree with the patient, hyocyamus may be substituted. Exclusion of strong light; spare diet, and rest of eyes, body, and mind, should be strictly enforced. The pupil should be kept under the influence of belladonna.

When once suppuration sets in, and pus is poured into the chambers of the eye, the sight is gone, and all the practitioner can then do is to relieve the patient's sufferings, and try to preserve the shape of the eye; this latter is sometimes very difficult, for if the chambers of the eye are filled with pus, threatening the rupture of the cornea, and accompanied with great pain, and much constitutional disturbance, the sooner the matter is evacuated by opening the cornea, the better, after which a poultice may be applied till the

whole of the humours come away, when the eye-ball will shrink up, and the eye-lids become closed.

Chronic Retinitis.—It has been already stated, that chronic retinitis can exist without the acute form ever being present, indeed such inflammation of the retina is by no means unusual, and perhaps it is the greatest cause of amaurosis that exists. Indeed, when chronic inflammation of the retina continues for any length of time, it is sure to produce such a disorganized state of the retina, that not only is it rendered insensible to light, but, generally speaking, the iris also becomes paralysed, and the pupil fixed and dilated, from the injury which the ciliary nerves receive. This state of the iris, however, does not always follow, for we very frequently find that the pupil continues to act by the stimulus of light, after the retina has become quite insensible to any impression.

Symptoms.—The patient first complains of a gradual decay of vision, and a weakness of sight, with intolerance of light: objects first become misty and confused, then false objects present themselves, such as dark spots, of various forms, floating in the atmosphere, to which the term *muscæ volitantes* is applied; next a fixed spot, of a dark color, comes before the eye, generally in the very axis of vision; this spot (*scotoma*) which is at first small, increases in size and darkness, until the whole field of vision is covered, and total blindness is the result. Before this takes place, however, objects become very imperceptible,—one day only part of an object will be seen, the next day less, and so on till the outlines only, of large bodies, are discernible. During this time another very distressing symptom is present, viz:—luminous bodies appearing before the eyes like falling stars. As the field of vision becomes covered with the dark spot, the patient will be observed to squint: this is caused by his trying to turn the sound part of the retina to the light; and this part, if the inflammation be then sub-

dued, may remain healthy, and thus the patient will have some sight left. The inflammation may spread to the capsule of the lens, and cause it to adhere to a part of the iris, which would give to the pupil an irregular shape ; but total blindness, *gutta serena*, may occur without the iris suffering at all, so that the pupil will continue to act even after the patient has ceased to discover light. The ciliary nerves, however, frequently suffer during the attack, which causes the iris to be paralysed, leaving a fixed and dilated pupil. When this takes place there is generally a dryness of the Schneiderian membrane and conjunctiva, and sometimes so great an insensibility of the latter that the patient will not mind the strongest stimulant when dropped on it : he will even draw his fingers over the conjunctiva, and not produce the slightest irritation. The appearance of the eye varies very much ; sometimes there will be slight vascularity, but generally speaking, there is no morbid appearance. Pain is very seldom complained of.

Causes.—Those who fatigue the eyes working by artificial light, are generally found to be the subjects of this disease, such as tailors, shoe-makers, dress-makers, printers, engravers, and those who read and write much at night. The reflected light from a country covered with snow, as in Canada in winter, is a very common cause. In nine out of every ten cases of this disease, that have come under my observation, the patients had dark eyes, which I consider a predisposing cause ; for I believe the transparent iris allows rays of light to fall upon the retina, when none should reach it except those which pass through the pupil.

Treatment.—The following extract is from the pen of Mr. Mackenzie :—“Cases of this disease are often injured by stimulant and tonic treatment, while, on the other hand they are greatly benefited by moderate and repeated depletion. A gentle course of mercury is also of use. Counter-irritants seem hurtful. The eyes must be spared, and the patient should try the effect of country air, and exercise.”

Mr. Walker speaks doubtfully of bleeding, but very favorably of mercury and counter-irritation, and tonics when the patient is of a strumous diathesis. In my practice I have met with very few cases indeed, of this disease, in which I could think of bleeding the patient, and in the few instances in which I have resorted to bleeding, I found no good to result from it. The treatment I have found to answer best is, mild aperients followed up with small doses of calomel and quinine, till the breath is slightly affected from the mercury. After pushing the calomel thus far I either continue the quinine, or give the ioduretted iodide of potassium ; or the infusion of colombo, with nitric acid. Should salivation be unintentionally produced, it always results in evil consequences. Dry-cupping on the nape of the neck I have always found beneficial, but I have rarely found any good result from counter-irritation.

Each day when the patient visits me, I make him hold his eyes over a phial of hydrocyanic acid, till it produces slight redness of the conjunctiva, which generally takes about two minutes, when the acid is fresh, after which I make him close his eyes till the redness disappears; my reason for doing which, is, that if the eyes are exposed suddenly to the light after the treatment, pain and intolerance of light will be produced.

Hydrocyanic acid acts both as a sedative and stimulant to the eye, and by exciting the action of the ophthalmic branch of the fifth pair of nerves, it restores the eye to its healthy action. With the same object in view, I daily brush the eye-brows and eye-lids with the solution of veratria. I have sometimes found good effects from giving an emetic at the beginning of the disease. Rest of the eyes is actually necessary, and benefit will no doubt be derived from change of air.

Iritis.—When we consider that the iris is composed of vascular, muscular, nervous, and serous tissue, we cannot

wonder that it should very frequently become the seat of inflammation. This inflammation may be either acute, chronic, or specific; and any of these varieties may be modified by a scrofulous diathesis, or by any other peculiarity of constitution, such as rheumatism, gout, &c. But I do not consider that the appearance of the iris explains to us what particular state of the constitution it is that thus modifies the inflammation; therefore, when I say that such a case is one of iritis modified by scrofula, this other modified by gout, and that one by rheumatism, it is because I find that each of these persons thus afflicted, possesses one of these peculiarities of constitution, and the inflammation of the iris is modified accordingly. Mr. Mackenzie has divided iritis into six different forms, viz:—1st. Rheumatic iritis. 2nd. Syphilitic iritis. 3rd. Pseudo-syphilitic iritis. 4th. Gonorrhœal iritis. 5th. Scrofulous iritis. 6th. Arthritic iritis. Now I cannot see what practical benefit can be derived from such sub-divisions of a disease, and it is remarkable what little difference Mr. Mackenzie makes in the treatment of all these different varieties, with the exception of what he calls scrofulous iritis.

The German oculists seemed determined that no one should ever acquire a knowledge of the disease, for they divided it into thirty varieties; which was enough in all conscience to frighten any student.* By the term iritis it must not be understood that the inflammation is necessarily confined to the iris, to the utter exclusion of other parts of the eye; far from it, for although no doubt such may possibly be the case, yet it is of very rare occurrence; and so general is the inflammation in the whole eye in syphilitic iritis, or so rapidly does the inflammation spread from the iris to other parts of the eye, that no great mistake would

* It was with them the term gouty iritis originated, therefore they give the arthritic circle as a sign of this disease, although it is an occurrence purely resulting from an anatomical cause.

be made if the case were called syphilitic ophthalmia. There have been many opinions as to which part of the iris the inflammation commences in, but this I consider of very little consequence, since every part of it soon becomes affected.

Acute Iritis.—There are certain symptoms to be observed in acute iritis, some of which are peculiar to itself, and others common to other forms of ophthalmia. The latter are photophobia, profuse lachrymation, deep seated circumorbital pain, generally aggravated at night; and the severity of all these symptoms is dependent upon the extent of the inflammation.

The characteristic symptoms of iritis, are, the vascular pink zone surrounding the cornea, on the surface of the sclerotica, dimness of sight, discoloration of the iris, contraction, immobility, and irregularity of the pupil; deposition of coagulable lymph on the capsule of the lens, effusion of pus or lymph into the chambers of the eye, particularly the anterior chamber, tubercles or pustules on the anterior surface of the iris; and sometimes there is even abscess in its substance. In the Dublin Quarterly Journal of Medical Science, No. 10, page 485, Mr. Wilde, after speaking of injuries of the cornea, says:—"We have lately had, in St. Mark's Hospital two cases of injury of the cornea from splinters of stones, which presented, on admission, all the symptoms above described. Upon the pus clearing off, so as to permit the lower segment of the iris to be examined, it was found to present the rare appearance of abscess in the substance of its tissues. An open ulcer, from which pus was discharging, was plainly visible upon the iris; and one of these cases, that of a man aged 35, presents, now that all the inflammatory action has subsided, the peculiar puckered, yellowish white cicatrix of the iris, which is represented in the accompanying illustration. The injury inflicted upon the cornea, in this case occurred towards the upper

portion, where a small leucoma, with attachment of a portion of the pupillary margin of the iris, still remains. The general haziness of the cornea is clearing off daily ; there is some vision remaining, and the form of the eye is perfectly natural. The iris could not possibly have received an injury where the cicatrix is situated."

I do not give the above quotation as a proof of abscess of the iris, for I conceive no proof exists ; I have had more than one of such cases where there was an open ulcer on the front of the iris, but never supposed it to be the result of an abscess ; on the contrary, I always considered it to arise from injury. It is very well for Mr. Wilde to say that in his case the iris could not possibly be injured, but we must consider the state the eye was in when he saw it, the anterior chamber filled with pus, and a sloughing ulcer of the cornea penetrating into the anterior chamber ; this last is evident from the fact that a portion of the iris remains strangulated in the cicatrized ulcer of the cornea. Mr. Wilde does not say he saw the size of the stone that caused the wound in the cornea, and it is possible it may have been an inch long, and if so it could wound the iris at any point ; or, granting that it was not thus wounded, it may have happened by some handy man, long before Mr. Wilde saw the case, poking a small probe into the chambers of the eye, through the wound in the cornea, to look for an imaginary foreign body that he expected to find there ; at least such is not a very unusual occurrence in Canada.

I give the quotation as a proof of how very rare it is for an abscess to form in the substance of the cornea, as the result of inflammation, when one with a so deservedly large practice in ophthalmic surgery as Mr. Wilde, remarks such a doubtful case as the one quoted.

The symptoms that I have given of iritis, vary in intensity according to the severity of the inflammation, and are best marked when the inflammation has not spread to any

of the other textures of the eye. The pink zone in iritis is about a line from the margin of the cornea, a white circle intervening between the zone and the cornea; this is caused by the vessels which form the zone perforating the sclerotica about one line from the edge of the cornea, and then passing to the iris. They are the anterior ciliary arteries, which, although few in number while passing over the sclerotica, before piercing that tunic, divide into numerous branches, and these becoming distended form the pink zone, the difference between which and the pink zone formed in inflammation of the sclerotica, being, that the former is about a line from the cornea, having a white line intervening, while in the latter the zone is upon the margin of the cornea. That dimness of vision should occur in an early stage of the inflammation, is easily accounted for—by the fact that the pupil becomes contracted, and also by the inflammation spreading so rapidly to the membrane of the aqueous humour. That the pupil should become contracted and immoveable is easily accounted for, when it is remembered that anything which irritates the ophthalmic branch of the fifth pair of nerves, whether inflammation or otherwise, will cause the pupil to contract, through the action of the third pair. I would not have the reader suppose that in every case of inflammation of the iris, the pupil is altogether immoveable, but in the mildest cases its action becomes very slow, and in very severe cases it is perfectly immoveable, and even sometimes will not be influenced by the action of belladonna. There are two causes, either of which may cause irregularity in the shape of the pupil; one is, that the fibres of one part of it may be paralysed, while the rest of the fibres are in rather a healthy state; and the other cause, which is the most general, is that part of the iris may become adherent to the capsule of the lens while the rest of it remains free, and this is not surprising when we remember that the serous membrane which covers the

iris also covers the anterior capsule of the lens, and all pathologists are aware of how speedily inflammation of serous membranes terminates in adhesion. If the whole of the pupillary edge of the iris is adherent to the capsule of the lens, there will be a contracted and fixed pupil.

The change which takes place in the color of the iris will depend upon what its natural color is. A blue iris, when inflamed becomes *greenish*, and a dark colored iris *reddish*.—"This" (says Mr. Mackenzie) "is the result of increased vascularity or effusion of lymph into its substance, or on its posterior surface." Mr. Walker says it occurs from a deposit of albuminous matter on the anterior surface of the iris, which impairs the transparency of the membrane of the aqueous humour which covers it. "Accordingly," (says he,) "the light colored iris, when seen through this partially opaque or turbid membrane, appears of a greenish tint, whilst the dark colored iris becomes of a reddish color; more rarely it happens that the discoloration is caused by a deposition into the proper texture of the iris." I certainly consider that Mr. Walker's reasoning is the best, at the same time it may be caused in the way stated by Mr. Mackenzie. The color of the iris, however, is of no practical importance further than as a symptom of iritis. The pustules or tubercles that form on the iris are situated on its anterior surface, and about the size of a pin's head, and are generally absorbed; sometimes, however, they burst, and pour out matter into the anterior chamber of the eye, forming a hypopium; but in this disease the hypopium is more generally formed by an effusion into the anterior chamber, of a fluid, resembling pus in color, but which is a morbid secretion of the membrane of the aqueous humour.

When adhesion between the iris and capsule of the lens takes place, lymph is generally deposited upon the capsule of the lens, and it will be seen to run in bands across the pupil, uniting the pupillary edge of the iris together.

When this takes place, recovery is very doubtful, indeed the case is much more likely to terminate in the formation of a false membrane over the pupil, or in closing the pupil altogether. All these reasons are sufficient to account for the dimness of vision which takes place in iritis, but there is another cause which occurs in the early stage of the disease, viz:—a diminution of the transparency of the humours, which gives to the pupil a cloudy appearance.

Causes.—The causes of acute iritis, so far as I have had an opportunity of observing, are similar to those which produce inflammation in any of the other tunics, nor have I found it more in gouty or rheumatic persons than in others, but I have found it more frequently in women than in men. Injuries of the cornea are a very frequent cause of iritis, and there is no worse form of acute iritis than what is termed the sympathetic, that is the sound eye sympathizing with the injured one, and in turn becoming inflamed.

Consequences.—The best termination of iritis is that effected by resolution. The unfavorable results are, *synecha posterior*,—adhesion of the iris to the capsule of the lens, with or without opaque lens, and closed pupil from deposition of lymph,—*cataracta lymphatica*, or false cataract, closed pupil by the pupillary edge of the iris becoming united, which is called *artresia iridis completa*; or there may be *artresia iridis incompleta*, which is when the lymph deposited expands, or separates, suffering the light to pass through a small aperture. One (though an unusual) result, is for the iris to be pushed forward and become adherent to the cornea, to which the term *synecha anterior* is applied. If there is ulceration of the iris, it will, if not all destroyed, become puckered up and shrunken. Another result is what is termed *cataracta pigmentosa*; this is caused by the pupil dilating, after the inflammation has subsided, and there has been *synecha posterior*, and leaving the pigment on

the capsule of the lens, it (the pigment or uvea) becoming detached from the posterior surface of the iris. In consequence of this last result, Mr. Dixon, one of the surgeons of the London Ophthalmic Hospital, condemns the use of belladonna in acute iritis, conceiving that it has no power to dilate the pupil while the iris is inflamed, and that it is likely to cause the above result, if applied after the inflammation ceases.* In this idea I cannot agree, for four reasons,—first, because there are very few cases of iritis so severe that the pupil will not dilate more or less by the use of belladonna; second, because there is no case where, if properly used, it will not assist to keep the pupil from closing; third, because it is even better it should be the cause of breaking up these adhesions between the iris and capsule of the lens, than to suffer them to remain and become permanent, even though cataracta pigmentosa should be the result; and fourth, that this consequence may be the result of iritis if belladonna was not used at all.

Treatment.—If the patient is healthy, strong, and robust, much benefit is likely to arise from a general bleeding, but generally speaking poor patients cannot bear such debilitating treatment. Whether the patient is bled or not the alimentary canal should be got into proper order by the administration of a dose of purgative medicine.

As soon as this effect has been produced, the quicker the system is got under the influence of mercury the better. If the patient is a fit subject for bleeding, the mercury may be pushed to salivation, and the effect kept up for a few days; but if he is of a bad constitution, the mercury should not be pushed to such an extreme, but stopped when the breath becomes tainted. The best way to administer mercury is small doses of calomel, combined with opium or hyoscyamus, repeated very frequently, say one grain of calomel every

* *Lancet*, March 4 and 18, 1848.

three or four hours. If the patient is of a bad constitution I would recommend a combination of quinine with the calomel. As soon as the mercury has been pushed sufficiently far, the quinine may be continued, and if it is found not to agree, the ioduretted iodide of potassium mixture may be substituted in its stead. If, notwithstanding these remedies, the disease still continues, and the inflammation becomes modified by scrofula,—iodine, hydriodate of potass, sarsaparilla, change of air, nutritious diet, &c., will be found serviceable, and I have frequently met with cases which, after having withstood every treatment, yielded to the calomel and quinine administered a second time, with the same precaution as at the first. If the inflammation becomes modified in persons of a gouty or rheumatic habit, the remedy of all others to be most depended upon is hydriodate of potass, in eight, ten and even fifteen grain doses. The thing next of importance in the treatment of acute iritis, and indeed in every form of the disease, is to try and keep the pupil if possible under the influence of belladonna. The best way of accomplishing this is to drop on the conjunctiva every day, the solution of atropine:* but the general way is to smear the eye-brows and lids with the extract of belladonna, the extract being first brought down to the consistence of cream, or oil, by mixing it in a little water. The atropine is the best preparation, but it is so expensive that few practitioners could afford to use it except with wealthy patients. When using the extract of belladonna, I always apply it round the back and front of the ears, and find it has just as good an effect as if applied round the orbit. My object in applying it to this part, is, that I may be able to apply the veratria round the orbit, which I do once every day. To derive any benefit from the use of belladonna it should be kept constantly moist.

* For this beautiful mode of using belladonna the profession are indebted to Mr. Wilde, of Dublin.

Blisters and other counter-irritants, on the temples, nape of the neck, and behind the ears, have been recommended; I have always found that they aggravated the disease.

During the treatment of acute iritis, perfect quietness of mind and body should be observed; the eyes of the patient should not be exposed to the glare of the sun or artificial light, but by no means should his room be darkened. I would not recommend his being confined to bed, but rather to his room, at the same time permitting his friends to visit him, and if the inflammation becomes modified, he should not be even confined to his room, but allowed to go about the house, and even out of doors if the weather be fine. During the very acute stage mild antiphlogistic diet is necessary, but such should not be continued long, for very soon it will be necessary to give light nutritious diet, such as broths, &c.; should the conjunctiva become engaged in the inflammation, the eight or ten grain solution of the nitrate of silver should be dropped upon it once or twice a day.

Chronic Iritis.—When acute inflammation of the iris subsides, and partakes of the chronic form, many of the severe symptoms already described, disappear, and others become less marked; still the morbid process, though of a slow and inactive character, gradually goes on till vision is destroyed. The pain sometimes disappears, or at least the patient complains very little of it, or indeed of anything else except dimness of vision; the vascularity of the sclerotic becomes very inconsiderable, although that of the iris itself may increase; the vessels can be sometimes seen on the capsule of the lens. If in the acute stage the pupil is contracted, irregular and motionless, it is doubly so in the chronic form, but intolerance of light is seldom complained of. It is when iritis is in the chronic stage that we find synechia anterior more generally produced; and this is

caused by the aqueous humour becoming absorbed, and not renewed, in consequence of the morbid state of its membrane; consequently the iris and lens having no support, fall forward against the cornea, and the anterior chamber is obliterated. The loss of the natural color of the iris is another symptom which continues in the chronic stage.

Chronic inflammation of the iris may take place without acute inflammation ever having existed; when such is the case the symptoms at first are not well marked. Its progress is very slow, and it is seldom found to spread to any of the other tunics of the eye, although generally speaking from the very beginning there is dimness of the cornea. The pain is very slight, and it is rarely accompanied with photophobia, lachrymation, or intolerance of light. What the patient most complains of is loss of vision. The vascular pink zone is found round the cornea, the iris loses its natural color, and the pupil becomes fixed; all these symptoms may continue for twelve or fourteen days before there is any sign of lymph being deposited. After this, some bands of lymph may be seen stretching from the pupillary margin of the iris to the capsule of the lens; finally, the capsule becomes opaque from the effused lymph. After this the whole eye-ball may become atrophied, or the aqueous humour becoming absorbed, and the lens and iris being pushed forward, the anterior chamber is obliterated, and the iris becomes adherent to the cornea.

Causes.—With the exception of scrofula it is very hard to say what peculiarity of constitution predisposes the iris to that peculiar inflammation termed chronic. If, however, the practitioner finds that the patient had suffered from gout or rheumatism, he is justified in considering either of them as a predisposing cause. I have remarked that numbers of the poor emigrants who were afflicted with fever in the summer of 1847, became affected with a chronic form of iritis in the winter following, and the majority of the cases

were in females. To this form of iritis the term post-febrile might be justly given, but I conceive it would be only multiplying terms without any practical use, as in reality it is nothing more or less than chronic iritis.* The exciting causes are similar to those which produce acute iritis. Injury of the cornea is very likely to produce it in strumous children.

Treatment.—An emetic and gentle aperient may be first administered, after which quinine and calomel should be given until the gums are slightly affected. This latter medicine should be given with great caution, not in frequently repeated doses as in acute iritis, but about one grain every twelve hours for a few days, and after that once a day will be often enough to take it. As soon as the gums are affected the calomel should be relinquished and the quinine continued. If the patient is a child it will be better to substitute the hydrargirum cum creta for the calomel. This is also one of those forms of iritis in which the greatest benefit is found from the administration

* The following cases will illustrate the benefit to be derived from quinine combined with calomel in these cases of iritis :—

Case 1st.—December, 27th, 1847, Hannah Grady, age 22, house servant, had her right eye affected for ten days; had the fever in the fall of the year. She complained of dimness of sight and great circumorbital pain. On examination, I found she had well marked iritis with hypopium.

I smeared her eye-brow with belladonna, and gave her calomel and opium every six hours till her mouth was affected. There was no check to the inflammation; I then gave her a quinine mixture, and ordered her one table spoonful every eight hours. There were ten grains of quinine in the eight oz. mixture. After taking two bottles of the mixture her eye was perfectly well.

Case 2nd.—January 21st, 1848, John McCallagh, aged 22, laborer, had inflammation of his eye six weeks; had fever in the month of September; never had syphilitic disease; I found that he had iritis of the left eye, and that he complained greatly of the circumorbital pain.

I gave him one of the following powders every eight hours :

℞ Sulph. quinine gr. i.
Submur. hydr. gr. i.
Pulv. opii. gr. $\frac{1}{2}$ M

As soon as his gums became soft the inflammation abated, after which I gave him an eight oz. mixture of quinine, to take one table spoonful three times a day; when the mixture was finished he was perfectly well.

of the hydriodate of potass. Light but nutritious diet, and exercise in the open air, are very necessary towards the accomplishment of a cure.

Belladonna and veratria should be used, as is recommended in acute iritis. I should not recommend blisters or any counter-irritants. If the conjunctiva be engaged in the inflammation, a solution of the nitrate of silver should be dropped upon it daily.

Syphilitic Iritis.—This is a secondary syphilitic affection, which rapidly extends its destructive influence to the whole eye-ball, so much so that it might be called syphilitic ophthalmia. The inflammation first attacks the iris, although from the very beginning the redness of the sclerotica is very remarkable. Dimness of vision is much greater than in any other description of iritis, and in a very short time from the commencement of the attack, opacities of the membrane of the aqueous humour and capsule of the lens are to be observed. The first stage of the inflammation has no sooner appeared than with the greatest rapidity it runs into the second, when puriform matter and lymph are deposited, and adhesion takes place. It is therefore in the second stage, when we examine the eye, that we more particularly find the chief characteristic symptoms of this form of inflammation. But in a disease that runs its destructive course so rapidly it is necessary that it should be diagnosed in its first stage, therefore in every form of iritis the practitioner should enquire into the history of the case; he should examine and see if there are any symptoms in the throat, or on the skin or the bones, that would shew a syphilitic taint in the system; in fact he should make every effort to know if the person ever had syphilis, and if so, when he had it, and whether he was cured by mercury pushed to salivation. It is true, cases will occur to which the practitioner will never get any clue, but generally speaking, he will find syphilitic iritis accompanied with some

characteristic symptoms, such as ulcers in the throat, or blotches upon the skin. Some authors say that it is accompanied with a particular description of eruption, but I have seen it with every description of syphilitic eruption, and much more frequently unaccompanied by any eruption at all. If the practitioner is baffled in the first stage of the inflammation, he should watch closely for the second, when the symptoms that have already been enumerated will more than probably afford him a clue.

Mr. Mackenzie speaks of a rusty color of the iris near to its pupillary edge, and pustules or tubercles on the surface of the iris; I have never been able to discover the rusty appearance he speaks of, and as for pustules or tubercles, they are often found where syphilis never had an existence. The characteristic signs given by Beer are irregular pupil and condylomata sprouting from the iris. Irregular pupil may be found in any form of iritis, and pustules or tubercles may be mistaken for condylomata. The following remarks are by Dr. Jacob:—"In the first stage of the disease, when the change in the structure and appearances is owing to mere increase of vascularity, it is, I believe, impossible to pronounce an opinion as to the character of the disease, from inspection of the eye; but in what I consider the second stage, the period of adhesion, effusion, and loss of transparency, I think a satisfactory diagnosis may generally be made, especially when the inflammation has been permitted to go on for some time unchecked. The opacity of the membrane of the aqueous humour takes place more frequently, and is more remarkable; the effusion of lymph or purulent matter into or upon the iris is more usual and characteristic; and the adhesions of the pupil to the lens are more rapid and extensive in formation. The opacity of the membrane of the aqueous humour is indeed almost exclusively found in syphilitic iritis. It occurs in that form of inflammation of the eye which is in a great degree con-

fined to the chamber of the aqueous humour, and which is generally observed in delicate females of a feeble frame or scrofulous constitution, but seldom, if ever, in the simple idiopathic inflammation of vigorous and healthy men."

With reference to the opacity of the aqueous humour, he says:—"I believe that the aqueous humour is seldom, if ever, rendered opaque by effusion of purulent or other matter into it; but, on the contrary, when purulent matter is secreted it does not become diffused or mixed with the natural fluid, but falls down, presenting the peculiar appearance called hypopium. That it appears very like a muddy or clouded state of the aqueous humour I admit, and this is rendered still more deceptive by the circumstance that the opacity seldom occupies the whole of the membrane of the aqueous humour, lining the back of the cornea, but is confined to its lower half or two thirds, leaving the upper part transparent, as if the opaque matter had subsided towards the bottom. It is, however, to be observed that the mottled or speckled appearance is not seen during the inflammatory stage; it is one of the effects or consequences which remain long after the inflammation has subsided. The opacity is at first a diffused, uniform, muddy or clouded patch, resembling, as has been seen, effusion into the aqueous humour.

"Syphilitic inflammation of the eye, although unaccompanied by any cutaneous eruption, sore throat, or other secondary symptoms, may generally be recognized from the greater amount of disease affecting the iris. That the yellow depositions of coagulable lymph or purulent matter, already described, may sometimes occur in other forms of inflammation, cannot be denied, but that they occur far more frequently in the syphilitic form, is equally certain. Whether we call them globules of lymph or abscesses, they are found in their most perfect and characteristic shape and appearance in this species of inflammation; so much so that

when present, I hesitate not to predict at first sight that on enquiry the existence of syphilitic disease will be established.

“These depositions have already been described when treating of the consequences of inflammation in its simple and uncomplicated form ; it only remains to add, that the dull-red, or light-brown irregular ring, surrounding the pupil, is perhaps found almost exclusively in the syphilitic species. The greenish yellow stain, on the other hand, is as often, if not oftener, observed in idiopathic inflammation after injury.”*

Mr. Walker, speaking of syphilitic iritis, says:—“I have already stated that syphilitic disease often extends to the iris, and gives rise to acute inflammation of its texture. This is a very frequent occurrence, so much so that when we find iritis among a certain class of individuals, we immediately inquire if there are any other symptoms of syphilis, either primary or secondary. Iritis is most commonly met with among the secondary or constitutional symptoms of lues, such as ulceration of the throat, and eruptive disease of the skin. It is well that you should be conversant with this fact, so as to be aware of the frequent combination of syphilis with iritis ; but I do not know that it will lead to any practical result, since the treatment of iritis, however excited, must always be conducted on the principles I have laid down, nor are there any diagnostic symptoms which could enable a practitioner to say, by merely examining an eye thus affected, that such a case is syphilitic or otherwise. It was formerly thought that the existence of tubercles and the displacement of the pupil upwards, were decisive of the syphilitic origin of the disease. Such a notion, however, is now completely exploded. You will find in several of our modern works, very elaborate articles on the subject of syphilitic, rheumatic,

* British American Journal, volume 2, pages 99—125—152.

arthritic, and strumous iritis. The condition of the system indicated by these different epithets, renders the eye, perhaps, somewhat more disposed to be affected by disease than in a person of a healthy constitution; but that such conditions materially or perceptibly modify the characters of ophthalmia generally, or of iritis in particular, is, to my mind, certainly not established; moreover, the treatment admits of no further modification, so far as the eye is concerned, than that I have already pointed out, and which relates more to the intensity and duration of the disease than to the exciting cause.”*

The reader must at once perceive the perplexing and contradictory opinions that have been given in reference to the local symptoms of syphilitic iritis; many others could be quoted, but none of them are so satisfactory as to leave no doubt upon the mind of the practitioner that such symptoms are confined to syphilitic iritis. For my part, although I have found this form of the disease more rapid in its progress than any other form, yet if there were not some constitutional symptoms present to assist me in my diagnosis, or the patient's own confession that at some period of time he had had venereal disease, I would be averse to deciding that the case before me was one of syphilitic iritis, from local symptoms alone. This disease is rarely found in children, yet it does sometimes occur, and then it is generally found accompanied by small irritable ulcers on the tongue and palate, the whole body is emaciated, and the skin of a pallid dingy color; unfortunately, the inflammation does not generally attract much attention in children till sight is irreparably lost.

The consequences already enumerated, as the results which might occur from acute iritis, are equally liable to be the result of syphilitic iritis, such as artresia iridis, irregular pupil, paralysis or loss of contractile power in the iris, opacity of both the lens and capsule, synechia anterior or pos-

* London Lancet, 1st volume for 1841, page 46.

terior, disorganized retina and consequent amaurosis, projection of the cornea or sclerotica, or the globe of the eye becoming shrunken and contracted, &c. Its general termination in children, when not cured, is disorganized retina and paralysed iris.

Treatment.—With some few exceptions, every thing that has been said in reference to the treatment of acute iritis, is equally applicable to the form termed syphilitic. Blood-letting, as a general rule, is seldom, if ever, required, indeed in the majority of people who suffer from secondary syphilis, bleeding is worse than useless. If mercury is useful in other forms of iritis, which is doubted by none, it is doubly so in the syphilitic form; indeed, there is no medicine that can be administered in any disease to which the human frame is liable, that will produce such decided, speedy, and good effects; nevertheless, cases occur where it is not only a useless but an injurious remedy; for example, cases where the patient has been already salivated, and debility produced, without checking the inflammation; under such circumstances the best thing that can be done is to alter the treatment, discontinue the mercury, and give either quinine or the ioduretted iodide of potassium, which is one of the best medicines that can be given under these circumstances. Good nutritious diet should be given, and even, sometimes, if the patient is very weak, a little wine will produce a good effect; however, it must be given with great caution. If the weather be fine the patient should have exercise in the open air, but under any circumstances he should not be confined to his room, but allowed to go about the house. It is in such cases that turpentine is found of so much use; this remedy for syphilitic iritis was first recommended by Mr. Hugh Carmichael of Dublin. In the year 1829, he published an essay on the subject, and since that time he has been abused by some, and applauded by others; I am inclined to rank myself among the latter

class, for I have found turpentine a most valuable remedy, not only in syphilitic iritis but in every other form of the disease ; but I must at the same time confess, that it has been so where mercury failed, or where, from some cause mercury was not admissible. I have also met with cases where turpentine had no effect in checking the inflammation, and from the moment the system became affected from mercury the disease rapidly disappeared ; therefore, I never would give turpentine in preference to mercury, but as a substitute, when, from some peculiar cause, mercury could not be administered, or when mercury had already failed in producing any good effect. Giving turpentine after mercury I think I have found to prevent a relapse of the disease : some have said that they found no good effects from turpentine, till it produced strangury ; my experience of it is different, for I have found that where strangury was produced, the disease became worse, and the remedy had to be given up for a few days till the urinary irritation had subsided, after which it was again repeated.*

While thus treating syphilitic iritis, the other remedies, such as the belladonna, veratria, &c., must on no account be neglected. As a general rule when tonics are indicated, quinine is the best, but I have frequently found the best effects from doses of nitric acid as strong as the patient's stomach would bear.

Aquo-Capsulitis.—In the articles on iritis and corneitis, inflammation of the capsule of the aqueous humour has been constantly alluded to. It has also been stated that this membrane, being a serous membrane, when it became inflamed, formed adhesions, particularly when the folds of it were in close contact, such as that part which covers the posterior portion of the iris, and that part which is reflected on the anterior capsule of the lens. When the primary seat of the inflammation is in the capsule of the aqueous

* For the mode of administering turpentine, see page 93.

humour, the disease is called aquo-capsulitis. This inflammation may be either acute or chronic in its character; that is to say, it may be either rapid or slow in its progress, and the symptoms may be either severe or modified. It is very rare to find it existing alone, as the inflammation generally spreads to either the cornea or the iris, or to both; when it spreads to the former all the symptoms of corneitis will be present, and when to the latter, all the symptoms of iritis.

Symptoms.—The symptoms of this disease consist in a dull muddy condition of the aqueous humour, instead of the transparent color it presents in the healthy state; as it advances the muddiness becomes more distinct, so that sometimes the pupil and iris become quite indistinct. The humours also increase in quantity, so as to cause the cornea to become prominent, and the membrane itself becomes dotted with opaque spots. If the inflammation is acute, these symptoms will generally be found accompanied with inflammation of the conjunctiva or sclerotica, the cornea or iris being more liable to partake of the inflammation if it be chronic; if the inflammation continue long unchecked, lymph will be effused, and either form of synecha may be the result; or a coating of lymph may form over the membrane itself, which in time may become organized. The inflammation may extend to the retina, which may disorganize that tunic, and cause total loss of sight. The pain complained of is generally in the forehead with a feeling of fulness of the eye; there is not much intolerance of light, but it is sometimes attended with an increase of tears. The causes of this disease are similar to those already enumerated as producing inflammation in other parts of the eye, viz:—over exertion of the eyes, injuries, cold, &c.

Treatment.—Remembering that the part inflamed is a serous membrane, if it be in the acute form, the best treatment is bleeding and general antiphlogistic treatment, pro-

vided the patient is strong and of a healthy constitution, after which small and repeated doses of calomel and opium should be given, until the gums become slightly touched, when the calomel may be discontinued, and some tonic, such as quinine, substituted. The patient should not be confined to bed nor should the starving system be adopted, still the general diet should be light and nutritious, and not so strong as that used when in a state of health. If he be a poor debilitated person, bleeding should be resorted to with great caution, and I doubt much but that general bleeding would be injurious. The calomel also should not be pushed so far, and from the first it had better be combined with quinine. The same remarks hold good if the case is one of chronic or modified inflammation, when much benefit is likely to be derived from the internal use of turpentine or the ioduretted iodide of potassium; good effects may also arise from the application of stimulants to the conjunctiva. Whether the variety is acute or chronic the iris should be kept under the influence of belladonna; and in the chronic stage, or in the acute when lymph is deposited, benefit will be found from the use of veratria to the eye-brows and eye-lids, and fumigating the conjunctiva once a day with the fumes of hydrocyanic acid; this treatment excites the action of the absorbents, by restoring the healthy action of the ophthalmic branch of the fifth pair of nerves. Mr. Wardrop recommended and spoke highly of the good results following evacuation of the aqueous humour in cases of aquo-capsulitis. The authority is good, and if I found any necessity for it I should not hesitate to follow his advice.

Inflammation of the Lens and Capsule, producing Cataract.
In the *Lancet* for March, 1841, there is a lecture on this subject, by Mr. Walker, in which he makes use of the following language:—"I shall not occupy your time by entering upon a detailed account of *lentitis* and *capsulitis*, because

these conditions are merely the result of extension of inflammatory action of the iris or some of the internal textures of the globe.

“Morbid changes of the crystalline humour or of its capsule, however, originating, are always followed by one striking alteration in its appearance, viz:—a loss of transparency, the technical name of which is *cataract*.

“Opacity of the crystalline lens, or cataract, is no doubt occasionally the result of increased action or inflammation; more commonly, however, it seems to depend on a diminution or loss of vitality, the vessels supplying the lens being weakened or impaired in their action, or in some instances they may be even cut off or ruptured, as may be supposed to be the case when cataract supervenes upon blows or other injuries inflicted upon the eye. Doubtless it is from diminished vitality that the morbid condition so frequently arises in elderly persons. A similar state of opacity is likewise frequently noticed around the margin of the cornea at a somewhat advanced period of life,—the condition of which I formerly spoke as constituting the appearance termed *arcus senilis*, and which, according to Dr. Ammon, is always accompanied by a corresponding opacity of the circumference of the crystalline.”

Now I cannot agree with Mr. Walker that inflammation of the lens and its capsule, is solely the result of extension of inflammatory action of other textures; I grant that such is very frequently the case, but reasoning from analogy, and when we remember that these parts are as well supplied with vessels, nerves, &c., as other parts, I conceive that the lens and its capsule may be the primary seat of the inflammation. Nor do I at all agree with Mr. Walker, when he says that the result of *every* morbid change that takes place in these parts, must of necessity be followed by cataract, unless he would call that opacity a cataract which disappears on the subsidence of inflammatory action; there

indeed his idea would be correct ; but it does not appear that he means any such thing. I conceive every case of cataract, whether capsular or lenticular, even those cases which occur in old age, to be the result of inflammatory action, with the exception of those which occur suddenly, whether produced by blows or otherwise. There can be no doubt but that in some instances there is diminished vitality of the part, yet this very state must be considered as the result of chronic inflammation ; but if cataract were alone dependent upon diminished vitality, we should first have opacity of the hyaloid membrane and vitreous humour, and of the membrane of the aqueous humour, for their vital organization is much less than that of the lens and its capsule. But a question worthy of consideration is, why do the lens and its capsule generally remain opaque, and even very often increase in opacity, after the inflammatory action has been subdued ? I attribute this to the power of the absorbents having been diminished by the severity of the previous inflammation. But it may be argued that pain is one of the symptoms of inflammation, and that in the formation of cataract there is none. It is very true that one of the symptoms of inflammation is pain, but it need not necessarily be present ; as a proof of which inflammation of the heart and other parts is an example.

Inflammation of the lens or its capsule, whether spontaneous or traumatic, may be either chronic or acute, but they more generally partake of the chronic form. The inflammation may commence in these parts, and extend to other parts of the eye, or it may not spread at all ; or, as has been already seen, it may commence in other parts of the eye and spread to the lens and its capsule. If inflammation of the lens or its capsule is not subdued in the early stage, frequently they will continue opaque even after the inflammation is subdued. This opacity is termed *cataract*.

Symptoms.—The symptoms of inflammation of the lens or its capsule, while in the first stage, are very obscure indeed, and this, in my opinion, is one of the causes of so many cases of cataract, for I have no doubt, that if, in the first stage, the symptoms were as visible as they are in inflammation of other parts of the eye, the inflammation would be more frequently subdued than it is; but unfortunately we seldom see cases in the first stage, except traumatic cases, and if we do meet with them, we do not generally pay sufficient attention to them to diagnose what the case is that we have to treat. In order to a proper examination of the eye, particularly if we suspect inflammation of the lens or its capsule, we should first get the pupil well dilated, by dropping on the conjunctiva the aqueous solution of atropine; then examine the eye in a good light with the assistance of a double convex lens. If the inflammation is in the anterior capsule of the lens, small blood vessels will be seen to cross its surface, sometimes presenting a varicose or knotty appearance. If the posterior capsule is the seat of the inflammation the appearances of the blood vessels are very similar, but something more obscure, and larger towards the centre than at the edge; the membrane presents a muddy whey-colored appearance, and the pupil, when not under the influence of the atropine, does not contract so much as when it is the anterior capsule that is inflamed.

If the inflammation is in the lens, there are no vessels seen towards the centre, unless the patient is very young, but they form a small red zone round the edge of the lens, behind the anterior capsule. The pupil is generally contracted. In lenticular inflammation there will be a general dimness of vision; in capsular, dark strokes and spots will be complained of before the sight; and in both cases objects will often appear not only double, and treble, but I have seen cases where every object appeared to the patient sextupled, even when one eye was shut.

The inflammation may extend from the capsule to the lens, or from the lens to the capsule. When the anterior capsule is the seat of the inflammation, we more generally find it extending to the retina than if it were the posterior capsule or the lens itself that was inflamed, which is easily accounted for, when it is remembered that both the retina and anterior capsule are supplied with blood from the one source, viz:—the central artery of the retina; and I have remarked that anterior capsular cataract is oftener combined with amaurosis than any other form of cataract. The iris and pupil are more liable to suffer when the lens is the seat of the inflammation, which can also be accounted for by the anatomical fact that the lens receives its vessels and nerves from the ciliary, by means of the ciliary processes and posterior edge of the iris. As has been already stated, the inflammation in any case may not spread further than its primary seat, and if not subdued it is sure to terminate in opacity, or cataract, and even the opacity may remain after the inflammation has been subdued; and this is more likely to occur in the traumatic than in the spontaneous, in those cases where the inflammation is the result of an injury.

Causes.—The causes are similar to those which produce inflammation in other parts of the eye, such as injuries, &c.; very many cases are produced by wearing the eyes on small objects, by artificial light, and by constant employment over fires, as is the case with cooks, men employed at furnaces, glass-blowers, &c.

Treatment.—If the cause be a wound of the capsule and lens, there is generally speaking very little, if any, chance of preventing the formation of cataract, which must finally be removed by an operation, for generally, in such a case, the lens will become absorbed, and the capsule remain opaque, even after the inflammation has disappeared; when such an occurrence takes place, it is better not to make any

attempt at an operation for ten or twelve months after, when the capsule may be torn up with a cataract needle. Although, however, there is but little chance of preventing the formation of cataract, yet the inflammation that exists at the time, should be subdued by the ordinary means necessary in inflammation of any of the internal parts of the eye, produced by an injury ; but the practitioner should take good care not to injure the patient's constitution, and render him debilitated by antiphlogistic treatment and mercury, in the hope of clearing the opacity. If the case be seen in the first stage of the inflammation, whether the cause be spontaneous or from an injury, the treatment must be antiphlogistic, but it should never be pushed too far. I generally begin with an emetic and purgative, followed up by cream of tartar drink, containing minute doses of tartarised antimony. I resort to local instead of general bleeding, keep the pupil under the influence of belladonna, and direct that the eyes have perfect rest, and be not exposed to strong light.

If the disease run into the second stage, and the vascularity disappears, leaving the parts opaque (cataract in the incipient stage) the treatment must be altered at once, and recourse had to alteratives and tonics, such as calomel and quinine combined, or nitric acid, mixed in molasses so as to enable the patient's stomach to bear it in large doses. Benefit will also be derived from the internal use of the ioduretted iodide of potassium. The local remedies are, keeping the pupil dilated by means of atropine, or belladonna ; fumigating the conjunctiva once every day with hydrocyanic acid, brushing the eye-lids and eye-brows with the solution of veratria, insulating the patient and drawing electric sparks from round the orbit and from the eye-lids, and keeping up a counter-irritation behind the ears by applying to these parts the tincture of iodine. It is just as necessary that the patient should avoid strong light, and

every other exciting cause, as if it were acute inflammation that existed.

By the above treatment, long persevered in, I have not only succeeded in curing hundreds of cases of incipient cataract, but have also in very many cases succeeded in giving old people, who could not make their way alone, such sight as enabled them to read a moderate sized print. The three following cases of cataract will illustrate the possibility of this disease being sometimes cured without operation. The third case, will also be one of the best proofs of the curability of opacity of the cornea, as the disease had existed for a period of 59 years, full time certainly for nature to exert herself to perform a cure.

Case 1st.—Mrs. R———, aged 75, a lady well known for many years in the higher ranks of society in Montreal, sent for me on the 21st of January, 1846, to consult me for disease of her eyes. She stated that, “for the last few years her sight had been gradually getting dim, and that the dimness had rapidly increased for the last two months, so that at that time she could hardly know one person from another, except by their speech.” Her general health was very bad, and she was constantly under the care of her family physician.

On examining her eyes I found she had capsulo-lenticular cataract of both eyes, so far advanced in the left as to be ripe for operation, but not quite so far advanced in the right eye. I at once saw that she was not a fit subject for operation, and therefore determined on another mode of treatment, and although I did not promise her, nor expect myself, much benefit as the result, I had the satisfaction of seeing her, as had also many others, able to read her Prayer-book after the space of about two months, during which time I saw her every second day, when I fumigated her eyes with the hydrocyanic acid, having the orbits smeared round at night with the extract of belladonna, not being able to procure atropine at the time.

During my treatment her physician was giving her tonics. This lady is now dead ; were she living I know I should have full leave to mention her name.

Case 2nd.—The patient in this case was a lady well known to nearly every person of respectability in the Province of Canada, who has kindly written me a letter with permission to make use of it : it will accordingly be found below. *January 18th, 1847,* I was called upon by Mrs. M—— of ——, (C. W.); she stated her age to be 57, “that she could just discover large objects undefined, when moved between her right eye and the light, but that she did not mind about it as she had been blind of it for a long time ; that she more particularly wished to consult me about her left eye, which had been getting so dim, for some time back, that at that time she could not read with it, nor indeed make much use of it, and that every object she did see was multiplied five or six fold ; the moon, or a lamp, for example.” On examining her eyes I found she had capsulolenticular cataract of both eyes ; ripe for operation in the right. She did not like the idea of an operation, nor did I press it till other remedies should fail ; I told her that I did not expect to be able to do much for the right eye, and that she might be satisfied if she had good sight in the left, nevertheless, that I would give both eyes the same treatment ; she attended me daily for nearly a month, when she left me with the sight of her left eye so perfectly restored, that she could read and write with ease. In the June following this lady paid me a visit as she was passing through Montreal, when I saw such a change in her right eye for the better, that I urged her to return to me again for a short time. In a week, or ten days following, I received the following letter from her :

———, C. W., June 28, 1848.

MY DEAR SIR,—On leaving Montreal, I almost promised you to return shortly, and place myself under your care for

a few days longer, but I find it will not be practicable for the present, and should the sight in my right eye continue to improve as it has done, I don't know that it will be necessary. I can mark its daily improvement, and in doing so always think of you with gratitude and regard, bearing in mind that when you first* operated upon it, I could but partly see the light, and now I am able to distinguish objects. At this moment I accidentally shut my left eye by rubbing it, and to my surprise found that I saw the pen in my hand very distinctly; this is indeed an improvement for which I have reason to feel very thankful, and very grateful to you, for the kind and judicious treatment which I received from you. And with every kind wish for you and yours, believe me to remain, sincerely your obliged,

A. M. M.

Case 3rd.—David T——, Esq., of Montreal, astronomer and surveyor under the sixth and seventh articles of the treaty of Ghent, aged 78, was led by his daughter to my surgery on the 24th of February, 1848. He stated that he had been blind of his right eye since February, 1789, and did not expect I could do anything for it, but that the sight of his left eye had been always good, up to the past three months, when it became a little cloudy, which cloudiness gradually increased, up to ten days previous to his coming to me, on which morning (the 14th of February) he awoke so perfectly blind as not to know that it was day-light. He stated that he had applied to two well known medical men, who professed to know something of the diseases of the eye, and they assured him nothing could be done for him.

I examined his eyes, and found he had capsulo-lenticular cataract of the left eye, fully ripe for operation; and a cicatrix in the centre of the right cornea, so surrounded by lymph as to render the whole of the cornea opaque, causing it to

* Meaning "Treated."

appear as though the sclerotica extended over the front of the eye; not one portion of the iris was observable through it.

This gentleman was able to come to my surgery by himself, after having daily attended me for three weeks. After attending me for three months he was able to read and write, and is now able, so far as sight is required, to read and write at all hours during day light; I prohibited him from writing or reading by artificial light; some time past he told me, that on the previous evening he had seen a particular star with his right eye, for the first time since he was of the age of 19. I then examined his eyes, and found scarcely a vestige of cataract remaining in the left eye; and the right cornea so clear; that the whole of the iris and pupil were visible, even the cicatrix was much smaller, indeed not more than half its original size.

The treatment in this case was exactly alike for both eyes; every day that he came his eyes were fumigated with the hydrocyanic acid, and his eye-brows, lids and temples, brushed with the solution of veratria; sparks of electricity were drawn from round the orbit about three times a week; and occasionally I dropped on the conjunctiva the two grain solution of atropine. For the two first weeks he took every morning a wine-glass full of the infusion of gentian, containing a small quantity of the sulphate of magnesia, and sulphuric acid.

Inflammation of the Hyaloid Membrane.—The following statement is made by Mr. Mackenzie in his work on disease of the eye:—"The morbid states in which the vitreous humour is occasionally found, such as synchysis or dissolution, dropsical increase, atrophy, unnatural viscosity, change of color, loss of transparency and ossification, lead us to regard the hyaloid membrane as susceptible of inflammation. A still more convincing proof is, that the vitreous humour is sometimes met with, on dissection, infiltrated with purulent matter."

I am not disposed to dispute Mr. Mackenzie's conclusions generally; yet he perhaps goes too far in attributing to inflammation of the hyaloid membrane, the infiltration of pus into the vitreous humour; I am, at all events, certain that where pus is effused into the vitreous humour, disorganization of other textures of the eye, as well as of the hyaloid membrane, will be discovered.

I know of no characteristic symptoms by which inflammation of the hyaloid membrane can be diagnosed, except those which are found in glaucoma, a disease which I believe to be inflammation, and its results, of that membrane; whether it begins in it and spreads to other parts, or whether it commences in these parts and extends to that membrane. I shall therefore treat of inflammation of the hyaloid membrane under the term *glaucoma*.

Glaucoma, or inflammation of the hyaloid membrane, may be either acute or chronic; but more generally it is of the latter form; it is a disease often confounded with cataract, which is not so much to be wondered at, when we remember the close connection there is between the hyaloid membrane and the posterior capsule of the lens; indeed I believe it is nearly impossible for the inflammation to exist in this membrane without the posterior capsule of the lens participating in it. When the practitioner examines a glaucomatous eye, the first thing that attracts his attention is a slight opacity of the vitreous humour, which he sees through the transparent lens, and he can at once perceive that this opacity is deeper seated than the lens, but as the disease advances the opacity comes in closer contact with the lens, making the diagnosis between cataract and glaucoma the more difficult.

One very remarkable circumstance to be observed in glaucoma, or inflammation of the hyaloid membrane, is, that from the commencement the opacity is of a greenish color, which becomes more marked as the disease advances.

From the first attack of the inflammation, the sight is misty, and for the most part diminishes gradually till vision is altogether lost. Although there is no doubt but that glaucoma can exist without the retina becoming diseased, yet so frequently is it found diseased in glaucoma, that Mr. Walker calls glaucoma, a variety of amaurosis. My opinion is that it may exist without the retina being disordered because I have seen patients with glaucomatous eyes, that is, with a slight greenish opacity of the hyaloid membrane, without vision being destroyed, nor were there any amaurotic symptoms present. Reasoning from analogy, I think we have a right to expect that the inflammation may be checked while it is confined to the hyaloid membrane and vitreous humour, leaving these parts more or less opaque, the retina remaining perfectly sound.

As the sight diminishes, in glaucoma, the pupil contracts, but when sight is completely gone the pupil becomes dilated and the iris paralysed. This latter effect appears to me to be caused by the surrounding parts being pressed upon, particularly the ciliary nerves, by the increased quantity of vitreous humour, for that there is an increase of this humour is quite evident from the fact of the eye-ball becoming large and hard to the touch.

When the patient complains of *muscæ-volitantes*, and fiery spectra of various shapes, before his eyes, with pain across the forehead, the surgeon may be sure that not only has the retina begun to suffer, but also the third and fifth nerves. Mr. Mackenzie says, that green cataract is always accompanied by glaucoma. Beer considers the subjects of glaucoma, and cataract *viridis*, together in the same chapter. I believe that green cataract cannot exist without the presence of glaucoma.

This disease is generally very slow in its progress; indeed it often takes years before it is matured, but when once it begins to advance more rapidly, it soon runs its full course.

It is generally found in persons of advanced life, and more frequently in the rich than the poor man. Very frequently when this disease is at its height, atrophy of the eye-ball sets in, after which it is not very unusual to find the other eye become similarly diseased.

Few have ever been so fortunate as to get an opportunity of examining a glaucomatous eye after death; I never had; Mr. Mackenzie seems to have been most favored in this respect, for he not only had cases of his own, but also friends who sent him specimens for examination; such professional friends are valuable indeed, and the more so as they are "few and far between."

For my part, however, I have no reason to complain, for there are many in Montreal, and elsewhere in Canada, who have acted in as friendly a manner towards me, so far at least as they had it in their power; and to whom my best thanks are due.

The following extract is from Mr. Mackenzie's work on the eye:—"I had long felt anxious to ascertain by dissection the changes which the eye undergoes in glaucoma, and being favored some time ago with several eyes in this state, I carefully examined them. They were all of them taken from subjects pretty far advanced in life. The following are the particulars which I observed in the greater number of cases:—

"1st. The lens of a yellow amber, yellowish-red, or reddish-brown color, especially towards its centre; its consistence firm; and its transparency perfect or nearly so. In some cases, however, the reddish-brown color of the central part of the posterior lamella was so deep as considerably to impair its transparency. This part was also drier than natural.

"2nd. The vitreous humour in a fluid state perfectly pellucid, colorless, or slightly yellow, no trace of hyaloid membrane.

“3rd. The choroid coat, and especially the portion of it in contact with the retina, of a light brown color, with little or no appearance of pigmentum nigrum.

“4th. In the retina no trace of limbus luteus, or foramen centrale.”

Those pathological researches of Mr. Mackenzie's are of great importance; all showing that the inflammation extended to other parts of the eye from the hyaloid membrane.

Causes.—Old age seems to be the only predisposing cause; as to the exciting causes, I suppose them to be similar to those which produce other forms of ophthalmia.

Prognosis.—From the history of this disease the reader must perceive, that whatever chance there is of checking the inflammation in the early stage, there is little or none when the disease has become advanced.

Treatment.—The treatment adopted by the Germans, is friction on the eye-brows with opium, and liniment of ammonia. Counter-irritation on the spine and behind the ears, with setons, issues, tartar-emetic ointment, &c. with applications of camphorated bags of aromatic herbs to the eye or eyes. Bleeding, purging, calomel and opium, &c., have been recommended, but I much doubt the efficacy of these agents, particularly when the patient, as is most likely, is an old person. Mr. Mackenzie speaks of the advantage likely to be derived in the early stages of the disease, from extracting the lens, but says he would by no means recommend its general adoption, as the operation would expose the patient to arthritic inflammation.

The treatment which I pursue in glaucoma is the same as that which I adopt in inflammation of the lens and its capsule, (cataract in the incipient stage.)

Ophthalmitis.—This term is made use of when we want to express, that the whole of the textures of the eye-ball, or nearly the whole, are in a state of inflammation. Mr. Mackenzie calls it phlebotic ophthalmitis, supposing that

such a state of inflammation was only produced by inflammation of the veins ; but this idea is altogether wrong, for the inflammation may be either traumatic or idiopathic as well as phlebitic. It is true that it is more generally found in women who get phlebitis after parturition, or in persons attacked with phlebitis from any other cause, such as tying a vein, &c.,—but it is very constantly found to be produced by lesions of the eye, such as those produced by operations, &c.

Symptoms.—When there is inflammation of the whole eye-ball, we naturally expect to find symptoms of every description of ophthalmia, and in fact such is the case ; but the most prominent symptoms are those that accompany iritis, aquo-capsulitis, sclerotitis and conjunctivitis, and these symptoms vary according to the severity of the attack and the cause of the inflammation. Phlebitic ophthalmitis is generally the most severe, but the symptoms are similar in all forms, whether phlebitic, traumatic, or idiopathic, only varying in severity according to the form, or if it be modified by a scrofulous diathesis. When thus modified the symptoms are not so severe ; the disease does not run its course so rapidly, the vascularity is not so great, nor is suppuration of the eye-ball so likely to be the result, although after a lapse of time abscess may form in the deep seated parts, which will end in destruction of the eye. The iris, capsule of the aqueous humour, lens, and the cornea, are the parts most likely to suffer. If the inflammation be not subdued, a very frequent result is for tubercular deposits to take place in the iris, which finally discharge themselves into the aqueous humour, or externally under the margin of the cornea. I have seen two cases ; the subject of one was a man, and of the other, a woman ; in both cases the tuberculated matter was deposited in the anterior chamber, its size about that of half a pea, color a muddy yellow, and apparently of the consistence of cheese.

According to the account of both patients, these tumours, though existing for years, had not increased in size. Sight was gone in both cases.

When the disease is not modified by scrofula the iris changes its color, the pupil is contracted, the lenticular capsule becomes opaque, the aqueous humour is muddy, and sometimes tinged with blood. The patient complains of great pulsatory burning pain at the bottom of the eye, extending from thence to the temple and forehead, and a tense feeling in the eye-ball, as if it would burst. Preceding this stage, and before vision is lost from disorganization of the retina, fiery spectra before the eye are complained of, with a great intolerance of light. From the first stage the conjunctiva is swollen, and forms a chemosis of rather an amber color.

When the inflammation has advanced to the above stage, suppuration sets in at the bottom of the eye and orbit, and if the patient lives, it is poured out into the posterior chamber of the eye, when it pushes the iris forward against the cornea. At this period the patient's sufferings are very great, and, if the case is left to nature, the only chance the patient has of life is, by the spontaneous evacuation of the purulent matter from the bursting of the eye, which generally takes place through the cornea, but sometimes through the sclerotica, when the latter, the matter becomes lodged under the conjunctiva. But it often happens that before the spontaneous evacuation of the matter, the patient's sufferings are terminated by death, which generally takes place during a fit of convulsions.

When rigors, delirium, and convulsions supervene, the case generally terminates fatally. When once disorganization of the eye-ball takes place the most favorable termination that can be expected, is, to have the shape of the eye preserved; as to vision, it is lost for ever.

Causes.—I have already mentioned that phlebitis and injuries are the chief causes of ophthalmitis. It sometimes occurs after severe forms of fever, such as scarlet and typhus fever.

Treatment.—In the early stage of this disease the remedies to be depended upon are both general and local, but chiefly the former. If the patient is strong and in robust health, general bleeding should at once be resorted to, and local bleeding with leeches, or cupping, may be necessary afterwards. After the patient has been bled he should get a good purgative and nauseant, such as salts and senna, with a small quantity of tartarised antimony in it. After this, calomel and opium should be given in minute doses every three or four hours, until the gums become sore; in which state the system should be kept for a few days by the patient taking one or two doses of calomel in the twenty-four hours. During this treatment every means should be taken to keep the pupil under the influence of belladonna. The regimen should be antiphlogistic. If all goes on well and the inflammation abates, the mercury may be discontinued and the treatment changed. It will then be found necessary to give the patient some preparation of iodine, or nitric acid in sarsaparilla; turpentine will sometimes be found useful; and if the patient be debilitated he should get quinine; of all things it will be necessary to change his regimen, and instead of keeping him on slops, he should have good broths and even a little fresh meat: he should be allowed to go about the house and, as he becomes convalescent, to go out in the fresh air and take gentle exercise. But this, the usual plan of treatment, will sometimes fail, and not only fail but increase the violence of the disease, by debilitating the constitution without abating the inflammation,—I mean where there is such a constitution to be dealt with as the scrofulous, or in other words when the inflammation is modified by a

scrofulous constitution. The treatment in such cases is so well and ably explained by Dr. Jacob, that I shall quote his words :—“ In providing for the treatment of an attack of inflammation of the eye-ball in a truly scrofulous subject, the practitioner has to consider carefully the probable effect of the remedies he usually employs in ordinary cases, when applied to this form of disease. When alluding to the treatment of simple, uncomplicated, or idiopathic inflammation of the eye-ball, I suggested the necessity of reconsidering the opinions generally entertained, respecting the beneficial influence of depletion, in treating of inflammation modified by a scrofulous diathesis, or even by that languid or defective condition of the nutritive functions, which is often assumed to be scrofulous or perhaps equivalent to it. I have here to suggest a similar or even greater degree of caution. A patient presenting all the constitutional marks of scrofula, but otherwise in vigorous health, may be, and often is, benefited by local or even sometimes by general bleeding, but such a subject may also suffer from it, if it has not the effect of arresting the inflammatory action. The sudden abstraction of blood, by weakening the heart's action, and diminishing the activity of the capillary circulation, will often cause local inflammation to abate, or even to cease altogether ; but if it has not this effect, it often contributes to produce that state of the system which leads to effusion or deposition of serum, pus or lymph, or even of the peculiar material called tubercular ; and more frequently in scrofulous than in healthy subjects. In such subjects also, bleeding appears to have less effect in causing the inflammation to abate or cease, than in those not so affected ; and this I think especially to be observed when bleeding is resorted to after the inflammation has existed for some time, and has been thoroughly established. Bleeding should therefore, if resorted to at all in this form of inflammation of the eye, be resorted to at the earliest period, and with

the view of suddenly weakening the heart's action, and thereby diminishing the activity of the capillaries, rather than for the purpose of suspending nutrition, or interrupting the salutary and ordinary functions of the circulating organs. The local abstraction of blood by leeches or cupping, be its effect on the disease what it may, probably exercises less prejudicial influence on the constitution than general bleeding, and may therefore be adopted with less risk of bad consequences ; but in neither form is this resource, according to my experience, to be relied on to arrest inflammation in scrofulous as in healthy constitutions,

“The practice so generally pursued, of suspending the process of growth and nutrition, by denial of the usual quantity of food of proper quality, to arrest inflammatory action, also requires reconsideration, when it comes to be applied in scrofulous subjects more particularly. It should be recollected that persons cannot continue to live without a renewal of the blood circulating in their vessels ; and it is obvious that such renewal can be effected only by the administration of food capable of affording such blood. A sufficient supply of the ingredients necessary to sustain life, is also required to maintain a healthy state of the system, and without such healthy state of the system, inflammatory action cannot be controlled, or prevented from proceeding to the extent, of effecting destructive changes of organization. Acting on these principles, the practitioner should not, in scrofulous subjects at least, interdict for any length of time the use of nutritious food in sufficient quantity to supply the incessant expenditure of its elements by secretion and excretion. I do not mean to say that either in quantity or quality, the diet should be as generous as in a state of health, but the sudden and total discontinuance of animal and vegetable materials necessary to sustain life, or preserve health, and the substitution of those incapable of doing so, such as are commonly called slops, should not be

permitted. The peculiar character of inflammation in scrofulous subjects, is, its not yielding in a short time, or in a distinct way, either spontaneously or to remedies, but rather gradually diminishing in intensity, or becoming less active ; in other words not terminating so often in what is called resolution, but becoming chronic ; we should, therefore, be prepared to encounter a protracted state of the disease, and to provide for its consequences by sustaining the strength and health of the patient. With this view animal food should not be interdicted, as it generally is, from a prevalent belief that it induces a predisposition to inflammation, or when it takes place exasperates it. Animal food should not be given, especially at the commencement, in such quantity as to risk even a temporary increase in the quantity of the circulating fluids, and thereby to induce increased action of the heart, and corresponding activity of the capillary currents ; in other words the patient should not be allowed to make what is called a hearty meal, but he should have as much nutritious food as will secure the supply of the necessary quantity of blood, of good quality, to his system. Sudden and extensive change of diet should be avoided for another reason. The stomach and alimentary canal may have their ordinary functions disturbed or interrupted by the discontinuance of the usual digestible food, and the substitution of new and less agreeable aliments, and experience has fully proved that nothing contributes more to the destructive progress of inflammatory action than such disturbance. This, however, is a subject upon which I cannot venture to enlarge here, because it involves the whole question of diet and nutrition, in relation to scrofulous disease generally ; but I am induced to dwell so far upon it, because I so often see the evil effects of undue depletion, and defective nutrition, in scrofulous inflammation of the eye, and observe so frequently the reliance placed on medicinal remedies in its

treatment, regardless of this most important means of arresting its progress, and rendering its consequences less destructive. It should be understood that these observations are applicable to the treatment of all forms of inflammation of the eye-ball, although I have reserved them for the present occasion, because it is in the scrofulous form of disease the necessity of attention to the digestive, absorbent, and nutritive functions becomes more urgent. The practitioner should not confine his attention to diet alone, in providing for the improvement of his patient's constitution by means not merely medical. Respiration of pure air, frequently changed, the maintenance of the necessary amount of animal heat, and exposure to sufficient light, should not be neglected or forgotten. It is not only in the close, crouched, and uncleanly dwellings of the poor, that attention to respiration of pure air is demanded; the sleeping rooms, and nurseries, of affluent persons frequently require as much care, badly constructed as they generally are, for the attainment of this object, and encumbered as we frequently find them, with window and bed curtains, carpets, and unnecessary furniture. A volume might be written on the ventilation of sleeping apartments, and on the contrivances which might be adopted, to correct the defects of construction in our houses, which render a free circulation of pure air impossible.

“The measures to be pursued, with the same view, in the crowded rooms of the poor in large towns, or of their cottages in the country, would require an equal amount of space for their suggestion. I can, therefore, do no more here than direct the attention of the practitioner to the subject, and leave it to his judgment and opportunities to apply a remedy. The maintenance of a salutary amount of heat in the system, especially in young persons, requires attention also, difficult as it often is to secure it, in consequence of the direction of the currents of air flowing from

the doors and windows to the fire-place. A temporary screen, with the necessary clothing and bed covering, and in winter a fire of sufficient strength, will enable the attendant to effect this object. The exclusion of light, or immuring the patient in total darkness, is generally considered an essential part of the treatment in all inflammations of the eye, yet I am convinced that the practice is founded on erroneous views. It appears to be assumed that light must necessarily cause pain, and consequently irritation, if admitted into an inflamed eye, but this is a mistake. Light, it is true, often does produce this effect, especially in the advanced stages of the disease, and in peculiar forms of it, but as often do we find no inconvenience experienced by its presence. I therefore do not exclude light by closing the shutters or drawing the curtains, but merely as a precaution let down the sun-blind, or I direct the patient to sit with his back to the window or candles, as long as no complaint is made from exposure; being convinced that in the majority of cases distressing intolerance of light is induced by rendering the eye more sensitive to it by the use of shades and curtains. These observations respecting diet and general management are more applicable to what is called after treatment, than to the first attempts to arrest inflammation, but I have made them here because I so often see the evil consequences of a disregard of such means, followed by the worst consequences. The rule, from the very commencement, should be to avoid as much as possible making the patient an invalid, and in all cases where the practitioner can venture to do so, he should treat the patient without confinement to bed or bed-room, and even, if the weather be fine, allow exercise out of doors in shaded situations. The principles which I thus suggest to be applied in the treatment of scrofulous inflammation of the eye, have been advocated by writers on disease of this nature, both ancient and modern, and are therefore not

advanced as original. Mr. Carmichael long ago inculcated similar doctrines in his essay on the nature of scrofula.

“While treating of the other forms of inflammation of the eye-ball, I entered at such length into inquiries respecting the value of the various remedies proposed for its relief, that it is unnecessary to reconsider them now in detail. Antimonials, mercury, iodine, turpentine, iron, cinchona, sarsaparilla, guaiacum, and even colchicum, may, I conclude, be made as available, with the necessary limitations which circumstances demand, in scrofulous as in idiopathic, syphilitic, or rheumatic species. It is necessary, however, to suggest some modifications of these agents, to adapt them to the treatment of this form of disease. In a well marked acute attack of iritis or inflammation of the eye-ball, occurring in a scrofulous subject, mercury must be given under similar circumstances in other varieties, but the practitioner should not forget that he has to deal with a constitution which will not ultimately bear with impunity the effects of this remedy, as well as the ordinary or healthy one; and also, that in such a state of constitution the beneficial effects of a full and free course of mercury are not so apparent or decisive as in a sounder state of the system. The medicine should be more slowly and cautiously introduced, unaccompanied by that debilitating treatment so often adopted in other cases, and it may even be given in combination with tonics, and during the use of nutritious food. The preparation to be used requires consideration. The blue pill, with or without opium, as the state of the bowels demands, will generally prove sufficient, and in less acute cases the compound calomel pill, commonly called Plummer’s pill, may be found preferable. Corrosive sublimate (the muriate or bichloride of mercury) has been much extolled, and I believe extensively employed in this city, in the more chronic or protracted forms of inflammation both of the eyes and conjunctiva, but as the advocates

of it generally direct it to be dissolved in tincture of cinchona, by which it is of course decomposed, no evidence of its superiority is afforded. The value of iodine, as a remedy in inflammation of the eye-ball, has been considered when treating of other forms of this disease. It is, however, in scrofulous inflammation that its influence should be more relied on, if confidence is to be reposed in the opinion entertained respecting its virtues in this disease generally. I do not think that a practitioner would be justified in relying on iodine in any form, as a means of arresting in its first stage acute inflammation of the eye-ball, caused or modified by scrofula, but I think he may place reliance on it as an aid in the more advanced stages of the disease, either in combination with or following mercury. In cases of this kind the plan I pursue is to give mercury in moderation until it begins to produce its usual effects, and then to commence with the iodide of potassium. Five grains of the *pillulæ hydrargyri* are given three times a day until the gums become affected, and then continued in five grain doses, at night only, giving from five to ten grains of the iodide of potassium in the morning and middle of the day; after this has been persevered in until the mercury has had a fair trial, the pill at night is discontinued, and the iodine substituted for it, either alone or in decoction of bark, if the stage of the disease demands it; or the iodide of iron in syrup, in the dose of three or four grains daily, is given. In those cases in which the inflammation is a repetition of former attacks, or a relapse, or when it has been refractory and chronic, mercury having been freely and repeatedly used before, the iodide of potassium or iodide of iron affords an obvious resource, and under such circumstances I have seen it, I think, effect as much as could be expected from any other remedy. In the more advanced stages of the disease, or even at an earlier period, if it does not yield to the remedies above enumerated, tonics and nutritious food, removal

to a more healthy locality, and every other means usually resorted to in scrofulous affections, must be adopted. Cinchona or other vegetable tonics, in such form as the practitioner may consider best suited to each individual case may be employed with advantage, and iron, either alone or in combination with other remedies, should have a trial. Patients residing in large towns should be removed to the country, and even from one locality to another differently situated. As to the local treatment, little remains to be added to the observations already made under this head in treating of the other species of inflammation, except in enjoining more caution as to the application of blisters, which in scrofulous subjects so often are the cause of enlargement of the cervical glands."*

I conceive, as a whole, that these remarks of Dr. Jacob are most valuable to the practitioner, and will therefore make no apology for such a long quotation, but in a very few words conclude the subject of ophthalmitis.

The general remarks already made when treating of phlyctenular ophthalmia, are equally applicable to this disease when modified by scrofula.

The preparation of mercury that I give to an adult is calomel, and to a child the hydrargyrum cum creta; but in giving either preparation I combine them with quinine as even preferable to iodine; not that I do not give iodine, but I only administer it after I have ceased to give the calomel and quinine.

As in this disease the conjunctiva partakes of the inflammation, I daily apply to it a solution of the nitrate of silver, the strength varying according to the severity of the inflammation. If belladonna or atropine is useful in the acute inflammation, it is doubly so where the inflammation is modified by a scrofulous diathesis.

* British American Journal, August, 1847, page 101.

When ophthalmitis results in suppuration of the deep seated parts of the eye, the sooner the matter is evacuated the better, as delay, or leaving the matter to escape spontaneously, will only endanger the patient's life, without the hope of even preserving the shape of the eye. If matter is seen in the anterior chamber pressing against the cornea, it should be evacuated by opening the lower part of the cornea with a cataract knife; but if the matter is deeply seated it may be evacuated through the sclerotica, when the puncture should be made between the external and inferior recti muscles, and posterior to the iris. After the matter has been evacuated the eye-ball collapses, and relief is obtained. The after treatment consists in keeping the wound open with a dossil of lint, and a poultice applied to the eye; and whatever objections may be raised as to the employment of tonics in any other stage of the disease, at this, they cannot be dispensed with.

Compound Ophthalmia.—By this term is meant inflammation of more than one particular part of the eye. I conceive the term not only useless but one calculated to lead the practitioner, and more particularly the student, astray.

Traumatic Ophthalmia.—This term is applicable to inflammation in any part of the eye, produced by mechanical or chemical injuries, or by both combined. If there be inflammation of either the cornea or iris, produced by an injury, it is called traumatic corneitis, or traumatic iritis, as the case may be.

Artificial Ophthalmia.—This is traumatic ophthalmia; the only reason for calling it artificial, being, that the injury is wilfully inflicted by the person on himself. Soldiers and sailors, wanting their discharge, have been known to mutilate their eyes in this manner.

Intermittent Ophthalmia.—I observe the following article in the Dublin Quarterly Journal of Medical Science, No. 10, May, 1848, page 482, by Mr. Wilde, purporting to be

taken from the *Gazetta Medica di Milano*, February 27, 1847, and headed *Intermittent Quotidian Ophthalmia*:

“Dr. Lohman, during the intermittent fever which prevailed last year, observed the following case:—A man thirty-eight years of age, was attacked for five consecutive days, at the same hour, by violent pain in the left eye, accompanied with increased flow of tears, redness of the conjunctiva, and some intolerance of light. An hour afterwards the pain extended to the orbital region, and towards evening, about seven o'clock, the symptoms gradually diminished, perspiration ensuing. The next morning no sign of the disease remained. The right eye was not in the least affected. Before the occurrence of the attack each day the patient experienced some uneasiness, not, however, amounting to rigor. Leeches, blisters, and various applications, were tried in vain. The administration, however, of twelve grains of quinine cut short the disease on the sixth day.”

Until I had read the above case I very much doubted the existence of any particular disease of the eye, making its appearance at distinct and regular periods, which could be justly termed intermittent ophthalmia. Nor have I ever heard or read of any such before being perfectly proved, and I strongly suspect that the cases thus termed are generally caused by neuralgia of the ophthalmic branch of the fifth pair of nerves, accompanied by inflammation. I have had one case, however, of sclerotitis, where there was an increase of pain and inflammation every ten days for upwards of three months, till the disease was perfectly cured, but even in this case, as there was more or less inflammation in the eye and all the tunics, we should not, according to the true intent and meaning of the word, be warranted in calling it intermittent ophthalmia. Before I saw the man he had been bled, purged, salivated, blistered, and a seton had been put in the nape of his neck; all to no purpose. I gave him quinine in four

grain doses, from which he derived no benefit ; I then gave him the ioduretted iodide of potassium, and after continuing the use of it for three or four weeks his eye got perfectly well.

Sympathetic Ophthalmia.—When traumatic inflammation is produced in any part of the eye by an injury, and the other eye becomes inflamed through sympathy, this secondary affection is called sympathetic ophthalmia, and it is an extraordinary fact that it is generally the most severe form of inflammation. Lacerated and punctured wounds of a severe nature, are those injuries which generally produce sympathetic inflammation of the opposite eye to that injured, but it is astonishing what a slight wound or injury will sometimes cause it. I have seen it produced by the blow of a snow-ball.

Persons whose constitution has been injured by drunkenness and debauchery, are most liable to this form of inflammation. The usual period at which sympathetic inflammation comes on, is, from three to five weeks after the injury has been inflicted ; Mr. Mackenzie gives a case that occurred three months after.

Treatment.—If the treatment should be prompt and decisive in ordinary cases of inflammation of the eye, it should be doubly so in the sympathetic. It is in all respects the same, depending of course upon the part that is inflamed. Mr. Wardrop and Mr. Mackenzie hint at the necessity of evacuating all the humours of the eye that has been injured, and suffering the ball to collapse, as a means of saving the other eye ; this treatment was suggested by Mr. Wardrop, from his seeing Farriers practice it in similar cases in horses, with the desired effect.

CHAPTER XIX.

DISEASES CONSEQUENT UPON INFLAMMATION.

Granular Conjunctiva.—This disease, called also granular eye-lid, is always the result of purulent ophthalmia, and perhaps there is no one disease of the eye which causes the practitioner and his patient to get tired of each other sooner than this very disease.

Symptoms.—If the eye-lids be everted, their conjunctival surface will be found covered, in a greater or less degree, with rough irregular granulations, like those on the surface of an ill-conditioned ulcer. These granules are sometimes very small, and in other cases they will be as large as a pin's head. The upper eye-lid is always the worst, and as its rough surface is constantly passing over the cornea-conjunctiva, it produces a vascular opacity of that membrane, which causes an almost total loss of vision. This vasculo-nebulous state of the cornea always begins on its upper part, and soon after spreads all over its surface.

As these granulations secrete a great quantity of mucus, (which sometimes becomes purulent in persons of an unhealthy constitution, produced by a life of debauchery, drunkenness, or filth,) the patient finds his eye-lids glued together every morning when he awakes.

The general health very frequently suffers, and the more so if the patient be of a scrofulous diathesis.

Prognosis.—I consider the great majority of cases perfectly curable, although very tedious, if the parts have not been previously injured, and the character of the disease changed by the application of improper remedies; if, in short, it is granular conjunctiva, the result of purulent ophthalmia, that is to be treated.

Treatment.—In vain have I sought to cure this disease by any treatment recommended by authors or lecturers on

ophthalmology. I have tried them all with the same result, perfect failure. I have asked many medical men in Montreal, and elsewhere, whether they had ever seen a case of granular conjunctiva cured, and invariably the answer has been no; but several of them, with many medical students, can now testify, that they have seen many cases cured by me; and I do not think I am guilty of exaggeration in saying, that within the last four years, I have cured upwards of two hundred of such cases.

My treatment is both constitutional and local. Believing, as I do, that the granulations form in consequence of the diminished power of the absorbents, and that this is produced by the disordered state of the ophthalmic branch of the fifth pair of nerves, my object is to restore these parts to their healthy action, and thus get the granulations absorbed, and not destroyed, as is the usual practice. To accomplish this, the local application that I use is the acetate of lead, in the following manner:—When I first see the case I evert the lids, and then wipe the granulations quite dry with a soft sponge, after which I dust them over with the acetate of lead, it being previously pulverised in the finest possible manner.* I keep the lids thus everted with the lead on them for four or five minutes, then let a little water pass over them, after which I restore the lids to their natural position. If much irritation is produced I remove it, by brushing the parts over with a little olive oil. Every day after the first, till the eyes are perfectly well, I drop on the eye a large drop of the saturated solution of the acetate of lead, and order the patient to smear the edges of the lids, every night, with a small portion of the red, or Jannin's ophthalmic, ointment. If the case is not a bad one, I do not use the acetate of lead in powder, but depend altogether upon the saturated solution, which cures the disease equally

* I put the fine powder into a phial, then cover the mouth of the phial with a piece of fine muslin. This bottle I use as an ordinary pepper-caster.

well, but is a little more tedious than when the powder is used. To this solution there is not the general objection that there is to the other modes of using lead, that is, the formation of a deposit upon the abraded conjunctiva and an incurable opacity, for it may be used daily for months without any such evil consequences. The mode of preparing it, is to make a saturated solution of it in pure water, and then to filter the solution.

Every morning I brush the lids and round the upper part of the orbit with the eight grain solution of veratria, and if the patient is an adult, order him to take one table spoonful of the following mixture three times a day.

℞ Sulph. quinine, gr. viii.
Tart. ant. gr. i.
Acid, sulph. aromatic. gut. x.
Aquæ fontana. ℥viii. M.

I never confine my patient to the house nor keep him on antiphlogistic diet; on the contrary, I make him take plenty of exercise in the open air if the weather is fine, and order him to use good, wholesome food, both animal and vegetable, and even to take a glass or two of wine at dinner.

This treatment I have now adopted for four years, and I can safely say I have not met with one case of granular conjunctiva in that time, that I have not cured, excepting in some instances where the conjunctiva had been destroyed by the use of escharotics, such as the nitrate of silver, and the everlasting sulphate of copper, which is used so generally in this disease.

To enumerate all the different treatments that have been recommended for this disease would fill up pages; it is sufficient to say, that nearly every medicine in the pharmacopœia that could be tried either locally or constitutionally has been tried, and in vain.

Scarifying the lids, cutting off the granulations, escharotics, counter-irritation, &c., have been all recommended at dif-

ferent times by different authors. The local application from which I found most benefit before I used the acetate of lead (though without effecting a cure) is that recommended by Dr. Hays, of Philadelphia, viz:—a saturated solution of common salt. The treatment still pursued by Mr. Wilde of Dublin is to scarify the lids every fourth or fifth day, which he calls “firing,” and apply bluestone to them on the alternate days. The only thing new in this plan of treatment is the shape of the piece of bluestone; and he seems to consider this of importance. For the benefit of those who may desire to adhere to this plan, I will give his own words:—“The following *method of applying sulphate of copper* in the granular state of the upper eye-lid we have employed for some years; it will be found much more efficacious, less painful to the patient, and much more easily applied than the ordinary mode of proceeding. The piece of bluestone should be shaped somewhat like a spade in cards, with a blade about three quarters of an inch long, and filed down to the eighth of an inch in thickness. It should be fastened by its shank to a large quill, and occasionally rubbed smooth with a little water, to keep its edge and surface even. When about to be used, the lid need not be everted, but slightly lifted off the globe, by drawing the integument upward against the brow in the usual manner, and then the piece of bluestone may be inserted underneath the lid, towards the internal side, as high up as possible, and held a little out from the eye, so that it does not touch the surface of the globe. It is then drawn downwards and outwards towards the external angle. It is astonishing with what facility this manœuvre, after a little practice, can be accomplished, and what little uneasiness it causes the patient. Moreover, by this means we at once reach those large flabby granulations which are seated high up towards the reflection of the conjunctiva from the globe, and where,

owing to there being less pressure exercised upon them, they grow much larger than any where else.”*

Conjunctival Xeroma.—In Chapter XII., page 123, is described, lachrymal xerophthalmia, or dry eye, from a deranged or disordered state of the lachrymal gland.

The disease now treated of, is a dry eye caused by the conjunctiva not secreting its mucus, as a result of severe inflammation. Many causes have been assigned for the conjunctiva assuming this condition. Mr. Mackenzie thinks it is from the use of escharotics and stimulants when the eye is in an inflamed state. Whatever may be the exciting cause I consider the immediate one to be dependent upon a disordered state of the ophthalmic branch of the fifth pair of nerves; at all events we find that when amaurosis is produced by paralysis of this nerve, it is always accompanied with a more or less dry state of the conjunctiva; and I have always remarked that where this state of the conjunctiva is produced by inflammation, the inflammation has been modified by a scrofulous diathesis, and that the xeroma is always accompanied with some degree of amaurosis.

Some consider that it is caused by an obstruction of the lachrymal ducts produced by the inflammation; such a case I would call lachrymal xeroma.

Symptoms.—The conjunctiva not only feels to the patient perfectly dry, but it appears so to the observer. It becomes of a dark-red color and dusky appearance, the caruncula is flat, smooth, and dry, there is a feeling as if sand were in the eye, and the sight is very weak. It is generally accompanied with some degree of entropion, and the eye-lashes are dwarfish and irregular. The puncta are always contracted, and the mucous membrane of the nose dry. The cornea presents a dull appearance, with red vessels running over it. If the disease continues, the eye becomes difficult

* Dublin Quarterly Journal, No. 10, page 479.

to move, and the cornea, or its conjunctival covering, becomes opaque, and blindness will be the final result.

Treatment.—Whether the disease be curable or not, the patient's sufferings can be at least alleviated by keeping the conjunctiva moist with some saponaceous lotion, like that recommended by Walthre, in lachrymal xeroma. It is composed of a few drops of aqua potassæ to two ounces of tepid water. With this lotion the eye is to be bathed occasionally during the day, for a minute or more.

The only treatment I have ever found any benefit from in this disease, is the daily use of the veratria and electricity, in the way so frequently described in this work; soothing applications, to moisten the conjunctiva, with; quinine internally, and every other means likely to excite the action of the ophthalmic branch of the fifth pair of nerves, such as air, exercise, good food, and warm clothing.

Abscess of the Cornea.—This is always the result of inflammation; it differs from all other abscesses in not having a sac, being simply a deposit of pus or sero-purulent matter between the layers of the cornea. It was formerly supposed that in whatever part of the cornea this deposit was, it gravitated until it fell to the bottom, or lower edge, of the cornea, and there presented a white semi-circular opacity like the mark at the root of the finger nail, therefore the name of *onyx* or *unguis* was applied to it. However, it is quite evident that the deposit does not thus gravitate from the part in which it is first formed; I have myself seen many cases of it, and I never saw such an occurrence, and when the anatomy of the cornea is considered, it will at once shew how the weight of the matter could not thus separate the layers of the cornea. It is true that the abscess may form at the lower edge of the cornea. These facts were first shown by the late Mr. Tyrrell, and since supported by Mr. Lawrence, nevertheless many authors still adhere to the old idea.

There are three modes whereby an abscess of the cornea may terminate. It may be absorbed, it may burst outwardly leaving an ulcer of the cornea, or it may burst into the anterior chamber of the eye and form a spurious hypopium.

I do not see how there can be much danger in mistaking this disease for hypopium, even should the abscess be at the inferior edge of the cornea. Those, however, who call it onyx or unguis give the following diagnostic symptoms between the two diseases.

The onyx is the most superficial; when the patient stands upright the superior edge of the unguis is convex, while the same edge of the hypopium is horizontal or level. If the patient turn his head the shape of the hypopium is altered as the matter gravitates to the side; while such motion produces no change in the shape of the onyx.

Treatment.—The object of the practitioner should be, to use every means in his power to promote the absorption of the deposit. If there is inflammation present, the usual treatment recommended in corneitis should be adopted, but of all things no stimulating local applications should be used, as they always do harm. The plan of treatment I adopt, is to give calomel and quinine, in small and repeated doses, until the system is slightly affected by the mercury; I keep the system in this state for a few days, by giving a dose of calomel every night at bed time, but continue the quinine three or four times a day, I allow the patient air, exercise, and a free diet, of both animal and vegetable food.

During the above treatment, I keep the upper part of the orbit, and behind the ear, painted with the tincture of iodine, not as a counter-irritant only, but because the iodine excites the action of the absorbents. If I find, that with the above treatment, the matter is not absorbed, I discontinue the quinine, and substitute the ioduretted iodide of potassium in its stead.

Hypopium.—This term is given when pus, lymph, mucus, or serum, or any of these combined, is collected in the chambers of the eye: whether it is in one or both chambers, it is always the result of inflammation, and is of two varieties, viz:—*true* and *spurious*. A true hypopium is formed by the matter being secreted from some internal part of the eye, such as the membrane of the aqueous humour, the hyaloid membrane, or even the retina. A false hypopium is formed by an abscess, of either the cornea or iris, bursting into the anterior chamber of the eye. In the former the matter secreted often fills up both chambers of the eye, hiding the iris and pupil completely from observation. In the latter the anterior chamber is rarely, if ever, filled with the matter, and it can be seen running down from the abscess whether such abscess is in the iris or cornea. When the patient is standing upright, if the anterior chamber is not filled the superior edge of the hypopium is horizontal or level, and the inferior edge is semi-circular; when the patient turns his head to one side, the matter gravitates over to that side. When the chambers of the eye become filled with the matter, there is great pain and feeling of tension in the eye-ball, and if the matter continues to increase the cornea becomes prominent, and finally bursting, permits the iris to drop forward, when staphyloma will be the result.

Treatment.—The great object to be attained is the absorption of the matter, and this I conceive best accomplished, by the treatment already recommended for abscess of the cornea. If, however, the chambers become filled, and there is danger of the cornea giving way, the surgeon should not wait for such a result, but at once evacuate the matter by making an opening in the inferior part of the cornea, which opening must be sufficiently large to permit the matter, to escape without any force being used. So much has been said when treating of the different forms of

internal ophthalmia, that any further remarks here would be out of place.

Ulcers of the Cornea.—Ulcers of the cornea are always the result of inflammation, and are always accompanied by it, for so long as an ulcer exists, it keeps up the inflammation. These ulcers are of three kinds, viz:—superficial, deep, and transparent. When superficial, the corneal conjunctiva suffers most, and the ulcer is more extensive than when it is of the deep kind. The deep ulcer is smaller, and of a funnel shape. The transparent ulcer is so called from its clearness, and the difficulty there is in observing it; indeed it can be only seen in profile, whereas the others are seen when looking direct at the cornea; it appears as if it were a part of the cornea shaved off with a sharp instrument. When an ulcer forms at the edge of the cornea it is usually a deep groove, long and narrow, and is generally produced by the bursting of a pustule; it is not very dangerous, although it sometimes penetrates into the chamber of the eye.

The superficial ulcer is most frequently caused by the bursting of a phlyctenula, it spreads very rapidly over the surface of the cornea, and if not checked will soon destroy its superficial layers, and finally terminate in an incurable staphyloma by destroying the whole cornea. The deep ulcer is frequently the result of an abscess of the cornea bursting externally; the great danger to be apprehended from it, is its penetration into the anterior chamber of the eye, generally followed by a prolapsus of the iris, and this will be the more unfortunate if the ulcer is in the centre of the cornea; scalding pain, profuse lachrymation, and sometimes intolerance of light, accompany these ulcers of the cornea. The pain is caused by the extreme branches of the ophthalmic branch of the fifth pair of nerves being exposed to the tears.

The following remarks on the transparent ulcer are made by Mr. Wilde:—"The transparent ulcer of the cornea has been long known and described; in some instances, however, we are unable to detect it when we examine the cornea in front, and only become aware of its existence by observing it in profile, or making the patient roll the eye about. There is, however, a symptom attending this form of ulcer, with which we have been long acquainted, and which has not, that we are aware of, been heretofore described; it is the dark shadow thrown upon the surface of the iris by this ulcer, be it ever so transparent or so small, particularly when the patient stands opposite the light. At first view of this shadow, which is generally a dark circular spot, through which the natural color and striæ of the iris can be seen, it appears like an ordinary congenital mark, but from this it can be distinguished, by turning the head or eye from side to side, when it will be seen to shift its place on the surface of the membrane."*

The best termination there can be of an ulcer of the cornea is for it to heal, and as in every ulcer there is loss of substance, the consequence must be a cicatrix (leucoma) which will leave more or less of an opacity for life.

Treatment.—Much has been said on this subject in the articles on conjunctivitis and corneitis. If the ulcer continues to increase, and does not present a healing appearance, the local application most to be depended upon, is the nitrate of silver, the strength of which will depend upon the state of the ulcer; if it is a superficial or transparent ulcer,

* Dublin Quarterly Journal of Medical Science, No. 10, page 490.

In the British American Journal of Medical and Physical Science for November, 1849, the following remark is made by Dr. Macdonnell on this subject: "Mr. Wilde alludes to a dark spot always perceptible on the iris, immediately behind a transparent ulcer of the cornea, which he says is the best means of detecting such ulcers, and which sign he was the first to discover. As this dark spot is not *always* seen, and when present is not always immediately behind, but sometimes to one side of the ulcer, it is to be hoped that Mr. Wilde will follow up his interesting inquiry, and explain the cause of these irregularities."

generally speaking, it will do to drop on it twice a day the ten grain solution, which should be allowed to remain on the conjunctiva for three or four minutes: but if the ulcer is deep and likely to penetrate into the chambers of the eye, or if it has already thus penetrated, then this ulcer must be touched to its bottom part with the pure nitrate of silver; and this is best and most easily accomplished by wetting the point of a fine camel-hair pencil in water and then applying it to a pencil of the nitrate of silver; the point of the brush should then be introduced into the ulcer, and immediately withdrawn, when the ulcer will be seen covered with a white coating. By applying the nitrate of silver in this manner there is less danger of hurting the eye if the patient should suddenly start. If, in a few minutes after the application of the nitrate of silver, there is much pain, it may be relieved by letting a little milk run over the eye. When the pure nitrate of silver is used in the morning the ten or eight grain solution should be applied at night; in fact an ulcer of the cornea is the better of being always coated with the nitrate of silver, for it gives the patient relief; as the great scalding pain is produced by the tears running over the raw surface of the ulcer, so when the nitrate of silver is worn off, the pain that, for the time, had been relieved, returns again. When once the healing process commences, the nitrate of silver should not be used in its purity, and as the ulcer improves, the strength of the solution may be gradually diminished. When the ulcer begins to heal, a few red vessels will be seen to run into it and feed it, which is always a good symptom, though, strange to say, some have considered it a cause of the ulceration, and have gone so far as to take hold of these vessels with a forceps and cut them across. A most erroneous idea was, that the inflammation kept up the ulceration, when in reality it is the ulcer which keeps up the inflammation. While the nitrate of

silver is thus being used, much benefit will be derived from brushing the upper eye-lid and round the upper part of the orbit with the solution of veratria.

During the above treatment the patient should take quinine, with very minute doses of tartar emetic; he should have air and exercise, and be allowed a free wholesome diet; if that light should give pain he may have his eyes shaded, but not closed up with a bandage, as is too often the case. The eyes should have rest till they are perfectly well. For the treatment that should be adopted when the ulcer penetrates into the chamber of the eye, and is followed by a prolapsus of the iris, I must refer the reader to my remarks upon prolapsus of the iris. I would here, however, quote a few valuable remarks made by Mr. Wilde on the treatment of prolapsed iris:—"We still believe the best thing that can be done in penetrating ulcers of the centre of the cornea is to touch the rupture with a weak solution of the nitrate of silver, applied with a fine camel-hair pencil (but if the iris has protruded it is better to omit this); then to drop into the eye a strong aqueous solution of atropine; to close the lids carefully with a bit of isinglass plaster, extending from the forehead to the cheek; to apply the extract of belladonna plentifully in the usual manner all round the external parts, to lessen congestion and inflammation by local depletion, such as cupping or leeching, &c., and to relieve whatever other urgent symptoms may be present, to confine the patient to bed or the recumbent posture; to enjoin extreme rest, and not to meddle with the eye for forty-eight hours at least."*

The reader must at once perceive that Mr. Wilde speaks of prolapsus through the centre of the cornea, therefore it must be borne in mind, that if the perforation is in the edge of the cornea, the use of atropine and belladonna will only favor a prolapsus of the iris.

* Dublin Quarterly Journal of Medical Science, No. 10, page 489.

Opacities of the Cornea.

Nebula.—There are two descriptions of this disease, the vascular and non-vascular. I conceive the vascular to be the pannus of the cornea described by many authors, yet some have cavilled at the name, saying it is not true pannus; they then go on to describe the disease in a severe form, and call it *real* pannus. Mr. Mackenzie terms it a vasculo-nebulous state of the cornea, and describes it under the article on granular conjunctiva. The following are his words:—“Though the vasculo-nebulous state of the cornea now described, is owing in a great measure to the granular condition of the eye-lids, it would be erroneous to ascribe it entirely to this cause. It is no doubt partly an immediate result of the same inflammation, which has ended in hypertrophy of the papillæ of the palpebral conjunctiva.”

There is no doubt but that the primary inflammation has much to do in producing this affection, but that the granular conjunctiva keeps up and increases the disease is certain, from the fact, that the cure depends upon the removal of the granulations. The disease is also produced in a similar way by the friction of the eye-lashes, from trichiasis or entropion, and the cure depends upon the removal of the cause.

In the London and Edinburgh Monthly Journal of Medical Science, for July, 1843, there is a long article which was communicated to the Medico-Chirurgical Society of Edinburgh, by Dr. Hamilton, on the cure of inveterate cases of pannus by the inoculation of the matter of Blenorrhœa, by Dr. Stont of Vienna. In this article the definition that is given of pannus is an increased and morbid action (hypertrophy) affecting the sclerotic and corneal conjunctiva. It is divided into two varieties, viz:—*Pannus tenuis*, and *pannus crassus*. The former is defined as hypertrophy of the sclerotica and corneal conjunctiva, without disease of the submucous tissue, whilst in the *crassus* variety this submucous tissue is said

to be involved. The symptoms of the former variety are thus described:—"After a long continued inflammatory state of the conjunctiva, numerous delicate vessels extend from the sclerotica over the margin of the cornea, and expand themselves in the form of a greyish cloudy opacity, giving to the eye a dull and inexpressive appearance. These vessels increase in number, spread over the cornea to a greater or less extent, usually running from the superior edge of the cornea downwards. The pupil thus becomes partially or entirely covered, and the iris concealed from view. The symptoms of the second variety are—after obstinate inflammation, a thick tumified net-work of various vessels is found either primarily in the conjunctiva, or as the sequel of the foregoing variety. In high degrees of development the metamorphosis covers the whole cornea, giving to its entire surface a brownish red color, and producing numerous granulations. When the disease has proceeded thus far, neither the iris nor vessels can be distinguished, and the cornea appears to be involved; and if neither nature nor art arrest it, the sclerotic conjunctiva, especially in lax-leuco phlegmatic habits, becomes covered with a growth of red granulations, so called, almost insensible, but easily bleeding, which are so numerous that they sometimes appear confluent, encroaching upon the cornea until they totally cover it. Their increase separates the lids from the eye-ball, sometimes everting them.

"In this way a simple pannus may be mistaken for medullary sarcoma, and the more so as the separation of the brown crusts which form on the surface, frequently occasions considerable hemorrhage. Experience, however, proves that in this affection of the conjunctiva, the cornea often participates but little, and in the greater part of its depth remains quite transparent."

In treating this disease by the inoculation of blenorrhœa, we are directed to be sure that the general health is good, at

least that it is not below par, and that the subject for treatment should not be *gouty*, *scrofulous*, *rheumatic* or *syphilitic*; we are also directed to get the virus from a mild case of blenorrhœa; and if this be not easily obtained, we are directed to dilute with water the virus obtained from a more acute case; much of the matter is not to be applied at first, lest the disease produced (purulent ophthalmia) should be too severe. We are promised that the disease thus produced will clear the cornea perfectly in the course of ten or fourteen days, sometimes extending longer, even to six weeks. If inflammation threatens to go too far, it is to be combated by the usual antiphlogistic means; but we are informed that, generally speaking, it only requires simple treatment, such as the application of cold water. It is also stated that when both eyes are affected it will do to inoculate one, and the result will be the same as if both eyes were inoculated; while if only one eye is affected there is no danger of the sound eye becoming diseased from the application of the virus to the diseased eye.

I have never attempted this treatment, and would fear much to adopt it. And it appears to me that this pannus, about which so much is said, is nothing more than vascular nebula, at least the first form of it, and although I have never seen the second form, I think it quite evident that it is the first form in a severe degree.

By the term *nebula* I understand a cloudy opacity of the cornea, generally extensive and always undefined, opaque at its centre and less so towards its edge. It is caused by a thin serous effusion between the layers of the cornea, or between the cornea and its conjunctival covering. It is always the result of inflammation, and differs only from vascular nebula in not being accompanied with any vascularity of either the cornea or conjunctiva, from any cause whatever, whether granular lids or otherwise. The inconvenience that the patient suffers from such a state of the cornea, is that he sees objects as if through a mist.

Treatment.—The treatment of vascular nebula is to remove whatever may be the cause, whether granular lids or otherwise, which will remove the vascularity of the cornea, and perhaps its nebulous state also; if not, however, it will leave the case simple nebula.

The best treatment that I know to produce the absorption of non-vascular nebula, is fumigating the eye, or eyes, once every day with hydrocyanic acid, then dropping on the eye the six or eight grain solution of nitrate of silver; after which the eye-lids and eye-brows should be brushed with the solution of veratria, and the same parts occasionally electrified, by insulating the patient in the ordinary way, and drawing sparks from the parts. During this local treatment, quinine and minute doses of tartarised antimony should be given internally; alterative doses of mercury would sometimes be found necessary, and some preparation of iodine. Indeed I have found the ioduretted iodide of potassium of the greatest benefit in producing absorption of all opacities of the cornea.

The patient should be allowed to live his usual way, and take plenty of air and exercise.

Albugo.—This is a white speck in, or on the cornea, with well defined edges, generally of a circular form, dense in the centre, and of a pearly color. It is formed by an exudation of coagulable lymph, sometimes situated superficially and at other times deep in the substance of the cornea. The remote cause is inflammation, but the direct cause, is, when a phlyctenula, pustule, or abscess, is removed by absorption; and nature, making an effort to heal and unite the parts that have been separated by the matter, deposits lymph in its place.

Recent albugo is generally of a milky white, but as it grows old it becomes the color of pearl. Red vessels are sometimes seen running into the albugo; when such is the case it is called vascular albugo, which is generally superficial, and occurs in those of a scrofulous diathesis. This

description of nebula sometimes spreads, the other rarely, if ever, does so.

Leucoma.—This is a dense opaque cicatrix of the cornea, caused by a loss of substance, occurring from either an ulcer or wound of the cornea. The cicatrix is generally surrounded by diffused lymph, but is diagnosed from albugo by its puckered appearance.

Treatment.—The object in the treatment of all opacities of the cornea is the same, viz :—to produce absorption; therefore the remarks made on nebula, are equally applicable here and in the treatment of albugo. When one application is found to disagree, another may be tried in its stead; for example if the nitrate of silver or vinum opii disagrees, a solution of alum, acetate of lead, common salt, or the ophthalmic ointment of Jannin, either diluted or otherwise, may be used. But I have found the nitrate of silver to answer best.

It must not be supposed that a cicatrix can be removed from the cornea; all the practitioner must expect is to remove the lymph that surrounds it, and thereby render the opacity smaller, and thus give the patient better vision. I have never tried excision, as recommended by Dieffenbach, but should all other remedies prove a complete failure, I should not hesitate to give it a trial. I give the following quotation from page 313 of the *British and Foreign Medico-Chirurgical Review*, No. 8, October, 1849:—“Dieffenbach advises removal of the opacity by the knife. He says that the objection, that the subsequent cicatrix will be as opaque as the layer removed, is contradicted by experience.

“The operation consists in total or partial excision. Partial or superficial excision is very simple. The eye-lids are kept open by the speculum, the edge of the opacity is fixed by a small hook, and with a small thin knife the most superficial layer of the central portion of the opacity is carefully dissected off. This completes the operation. Cold

water is applied ; and after a few weeks, a further portion of the opacity is removed, and so on until the whole is taken away. The general result is, that the leucoma loses its cartilaginous whiteness, is smoother, smaller and clearer, partly from contraction of the new cicatrix, and partly from clearing of the deeper layers of the cornea. Complete excision is performed when a leucoma is thick and prominent, about the size of a pea, and lies directly before the pupil, so that the patient cannot see. It is fixed by the hook, and removed as before, without opening the anterior chamber, the edges are brought together by very fine sutures ; and Dieffenbach says that the result is great diminution in the size of the leucoma. If the whole thickness of the cornea is opaque, he passes the sutures before using the knife, cuts away all the leucoma, and instantly ties the knots, to impede the escape of the aqueous humour. He says he did this in one case successfully. We saw M. Malgaigne perform the superficial excision four years ago with perfect success ; and we saw a patient upon whom he had performed the same operation two years before, whose cornea was so perfectly clear, that it was impossible to determine upon which eye he had operated. Six months since we performed it ourselves, and very great improvement has resulted. It is by no means difficult to do. The opacity strips off with the assistance of but a few flat touches with the edge of the knife ; and we think the operation worthy of more attention than it has yet received in this country."

The following treatment of cutting the vessels running into the opacity was recommended by Scarpa :

"The eye-lids are to be separated from the affected eye by a skilful assistant, who is at the same moment to support the patient's head upon his breast. The surgeon is then to take hold of the varicose vessels, with a pair of small forceps, near the edge of the cornea, and lift them a

little up, which the lax state of the conjunctiva renders easy; then with a pair of small curved scissors, he is to cut away the plexus of varicose vessels, together with a small piece of the conjunctiva, making the wound of a semi-lunar form, and as near as possible to the cornea. If it should be necessary to operate upon more than one plexus of varicose vessels situated at some distance apart, the surgeon must elevate them one after the other with the forceps, and remove them. But when they are very close together, and occupy every side of the eye, he must make an uninterrupted circular incision in the conjunctiva, guiding it closely to the margin of the cornea all round, so as to divide, with the conjunctiva, all the varicose vessels.

In the *British American Journal of Medical and Physical Science*, vol. 2nd, page 287, there is an article of mine on the curability of opacities of the cornea. After this paper appeared some of the European Medical Journalists, most grossly, when they could do no more, misrepresented my statement, and made it appear that I proposed to cure cicatrix of the cornea, and that my only treatment for any opacity was fumigating the eye with hydrocyanic acid, whereas every case that I gave showed that I used other local, as well as constitutional, treatment; and the cases of leucoma only went to show that the opacity was rendered smaller by the lymph which surrounded the cicatrix being absorbed. I now state, without any hesitation, that if the treatment I have recommended for the removal of opacities of the cornea, be persevered in for sufficient time, it will cure as many cases, no matter of how long standing they may be, (for I have cured them after their existing forty years,) as the average number cured of any other disease of the eye. And I believe the best local stimulant that we have to accomplish this end to be the fumes from hydrocyanic acid.*

* In the *Dublin Quarterly Journal of Medical Science*, No. 10, page 483,

In reply to the remarks of Dr. Wilde, I would merely observe, in addition to what I have already said, that in the British and Foreign Medico-Chirurgical Review, No. 8, New Series, the Reviewer of M. Desmarres' Treatise upon the Diseases of the Eye, distinctly states that he has found no treatment so successful in opacities of the cornea as the vapour of prussic acid.

I take the following extracts from the Dublin Quarterly Journal of Medical Science, No. 10, page 486 :

“Acupuncture for the Removal of Corneal Opacities.—The foreign journals have been occupied during the past year with the details of cures said to be effected by this agent,

the following remarks are made by Mr Wilde :—“*Opacities of the Cornea, Collyria, &c*—In our report of last year we expressed our opinion pretty strongly on the subject of the various remedies proposed for the removal of specks and opacities on the cornea. The Journals teem annually with the praises of various therapeutical agents, the efficacies of which in such cases are said to be infallible. So long as those notices are confined to isolated cases, recorded by practitioners, who do not treat diseases of the eye on a large scale, and who simply relate that the patient had an opacity of the cornea, without stating exactly what the pathological condition of the parts were, we have no desire than merely to enumerate the various panaceas, from brandy and salt to prussic acid. But when we find a surgeon to an ophthalmic institution now extolling the virtues of the latter remedy for the removal of albugo, leucoma and nebula, we are inclined to examine the cases which he has recorded with some care. The Turnbull delusion of curing cataracts, corneal opacities, staphylomas, and even amauroses, by the vapour of prussic acid, has passed away in this country. Not so, however, in British America. Dr. Howard, of Montreal, has carried thither the hydrocyanic treatment of corneal opacities. It is said that “of eighteen with albugo, twelve were cured and six relieved, seven with leucoma six were relieved, and one abandoned as incurable.” Before we make any further remarks upon these broad assertions, we must here again, as we did last year, distinctly protest against the loose descriptions of corneal opacities, under the heads of specks, feathers, nebulae, clouds, pearls, leucomas, albugos, cicatrices, and even staphylomas of the cornea, which are daily reported to have been cured. In order to enable us to judge whether the case was one susceptible of cure by time, improvement of the constitution, the ordinary efforts of nature, or the use of local stimulants, we must have it distinctly specified what was the cause of the opacity, through what portion of the substance of the cornea it had proceeded, and whether there was adhesion of the iris to the cornea or not. Until these things are fairly stated by the ophthalmic surgeon, the profession must receive with caution the cures reputed to have been performed by any particular agent, even though the patient may have, as occurred with one of Dr. Howard's,—“before returning to Wales, his native country, left a certificate (as a voluntary effusion of gratitude), stating the benefit he had received.”

which has been particularly recommended by M. de la Flor, whose claim, however, to originality in its introduction has been disputed. The mode of treatment consists in introducing an ordinary acupuncture needle, previously dipped in a solution of prussic acid, into the cornea, within half a line of the sclerotic, at the superior and transverse diameters of the eye, consequently at four points; and allowing the needles to remain in for from two to five minutes. The needles are introduced sometimes nearly as far as the laminated cornea, sometimes as far as the aqueous humour, and in other cases to the lens, by which we suppose the reporter means completely into the anterior chamber. Upon withdrawing the needles reaction and inflammation is to be met by the ordinary means in such cases.*

“We have not seen this novel mode of treatment, nor are we sanguine in our expectations of it. It is possible, however, that the new action thus set up may excite absorption, and thus assist the removal of the opacity. We have seen cases of corneal opacity of long standing, which were very much diminished after a smart attack of inflammation.”

“*Cure of Corneal Opacity by Abrasion.*—Mr. Gzokalski says he has succeeded in removing opacity of the cornea by its central portion, with a knife, as a piece of paper is scraped to remove an ink-stain. He repeats the operation several times, removing very little each time, so as not to induce inflammatory action, and he never scrapes the membrane near its circumference, for he is of opinion that the central portion bears mechanical lesion much better than the circumferential.† “Herr Galtz of Vienna, some years ago, recommended, and also practised the operation of shaving off the external laminae of an opacity, so as to get down on the elastic cornea, which is seldom injured or opaque.”

* Gazette Medicale for 29th May, 1847.

† L'Union Medicale, March, 1841.

I have never tried acupuncture, but I think it much more feasible than either abrasion or shaving, for I do not see how an opacity can be removed except by absorption.

The six first of the following cases, are those which I published in the *British American Journal of Medical Science*, and which have been referred to in the preceding page. The three additional cases are vascular nebula with granular lids. In the cases given under "*Cataract*," there is also (in the third) an interesting case of opacity of the cornea.

Case 1st.—Albugo.—Mary Hanigan, æt. 30, wife of a labourer, had sore eyes for three years; for a year had merely distinguished the light, and the outline of large objects, and had not been able to go alone through the streets. She had an albugo on the right eye, and three on the left, completely obstructing vision. Perfectly cured in six weeks. Treatment—fumigations with hydrocyanic acid every day for ten minutes; after the lapse of another ten minutes, put one drop of a solution of nitrate of silver, the ten grain, into the eyes. For the first fortnight she took a wine-glass full of the following mixture every morning:

℞ Infusi. Gentianæ. ℥viii,
Sulphat. Magnesicæ. ℥i,
Acid. Sulph. Arom., ℥ss. M.

Case 2nd.—Albugo.—February 8th, 1846. Ann O'Berne, æt. 26, a servant, had been gradually losing the sight of the left eye for some time, but had lost it completely for the last eight months. Dr. ———, to whom she had applied, told her nothing could be done for her. On examination, I found an albugo completely obstructing the pupil of the left eye, in fact, occupying the whole cornea. Cured in two months. Treatment as in preceding case.

Case 3rd.—Leucoma.—December 26th, 1846. John Gil-land, æt. 22, a ploughman, had leucoma of both eyes,

completely occupying the left cornea, and preventing all ingress of light. The lower third of the right cornea was imperfectly clear, allowing of sufficient light to pass, to enable him to guide himself through the streets. Sufficiently cured in three months to guide the plough, a very small speck only remaining on the right cornea, and that not over the axis of vision; a small round spot over the axis of vision on the left cornea was removed. Treatment—daily fumigation of the eyes with hydrocyanic acid, and the subsequent application of Jannin's ophthalmic ointment, and every ten days the application of the solid nitrate of silver to the cornea. Internally took gentian and salts.

Case 4th.—Leucoma.—February 11th, 1846. David Wark, æt. 14, some time previously had received a blow on the left eye with a stick, which had ruptured the cornea horizontally, and in healing had left a cicatrix about three lines broad across the eye; on the outer side of the cornea the iris had prolapsed, and become attached to the cicatrix. He saw only the upper and under part of each object. Dismissed in six weeks with the cicatrix reduced to a mere line, and by his description, the vision as good as in the right eye. Treatment—daily fumigations with vapour of hydrocyanic acid, and a small portion of ointment put into the eyes each day: which ointment was composed of Jannin's ophthalmic, the citrine and spermaceti ointments.

Case 5th.—Nebula.—June 11th, 1846. Robert Hughes, æt. 55, a veteran, was led to the Institution by his wife; the right eye was destroyed, and vision in the left was completely prevented by nebula, both the result of inflammation. He had just arrived from New York, where he stated that he had been under the surgical treatment of the most eminent practitioners in that city, and hitherto the case had only gone on from bad to worse. After two months' daily attendance, he was discharged with very fair vision, sufficient to enable him to transact his ordinary business. The treatment con-

sisted in daily fumigations with the hydrocyanic acid,—a drop of ten grain solution of nitrate of silver, and often insulating him, drawing electric sparks from the eye and surrounding orbit.

Case 6th.—Nebula.—S. M. æt. 13, called on me on May 2nd, 1846, complained of dimness of vision of right eye, which had existed since he had had the measles in infancy. Had been treated unsuccessfully in New York by several oculists. The whole cornea was obscured by nebula; was perfectly cured in six weeks. Treatment—daily fumigations with hydrocyanic acid, and the application of the ten grain solution of nitrate of silver. During the treatment, I gave him the ioduretted iodide of potassium.

Case 7th.—Vascular Nebula.—April 29th, 1847. Pierre Bregon, aged 45, a laborer, whose eyes had been diseased for five years, applied to me on the above date. On examination, I found he had vascular nebula of both corneæ, with granular lids. I discharged him cured after two months.

Treatment.—The first day I touched the whole of the palpebral conjunctiva with the powdered acetate of lead, and after the third day I dropped on the eye every morning the saturated solution of the acetate of lead. The patient bathed his eyes night and morning with Mackenzie's soothing lotion.

Case 8th.—Vascular Nebula.—November 7th, 1847. Thaddeus Mc——, aged 28, store-man. Eyes diseased as long as he could remember, but much worse for the last five years; had been with many doctors, but received no benefit. On examination, I found he had vascular nebula of both corneæ, with granular lids. He is now perfectly well. The treatment same as preceding.

Case 9th.—Vascular Nebula.—July 15th, 1848. David Collins, aged 33, stone mason, residing at Augusta, State of Georgia, stated that his left eye was nearly blind for many years, that he had applied to many doctors for it, but had

received no benefit; could not now see more than light with it. On examination, I found he had vascular nebula of the whole cornea, and granular eye-lid with ptosis. He attended me every day for six weeks, after which time I discharged him perfectly cured.

The treatment the same as in the other two cases, with the addition that I applied the solution of vetraria every day round the upper part of the orbit, and gave quinine and tartarised antimony internally.

Synechia.—Any morbid adhesion of the iris to other parts is called synechia. When it is to the cornea it is called *synechia anterior*; and when to the capsule of the lens *synechia posterior*. It is always the result of inflammation or injury, and is generally accompanied by some other disordered state of the eye, such as cataract, opacity of the cornea, staphyloma, &c. The treatment for it is fully explained in the articles on treatment of cataract by operation, and the treatment for artificial pupil.

Obliteration of the Pupil.—By this term is not meant concealment of the pupil, by an opacity of the cornea, a hypopium, or any such cause; but a closed state of the pupil, whatever may be the direct cause. Closing of the pupil is called *artresia iridis*, *phthisis pupillæ*, and *synizesis*. By the latter term Beer meant a collapsed state of the pupil, not the result of inflammation, but probably depending upon a considerable loss of the vitreous humour, from a wound of the eye, or else a dissolved or disorganized state of that humour, the technical term for which is *synchisis*.

He also states that this is the only description of closed pupil that is not the result of inflammation.

In the articles on iritis, penetrating wounds, and ulcers of the cornea, it has been explained what means should be used to prevent the pupil from becoming contracted and finally obliterated; these are, smearing belladonna round

the orbit in the ordinary way, and dropping the aqueous solution of atropine upon the conjunctiva.

These means should be steadily persevered in for a long time, even after the inflammation has abated, but when they fail, the only resource remaining is a surgical operation, by which an opening, or artificial pupil, is made in the iris.*

Artificial Pupil.—An artificial pupil is formed by one of three different operations, which have been a long time practised by ophthalmic surgeons, and which have not admitted of much improvement since, although attempted to be modified by some modern surgeons, who as a general rule have only complicated the operations by recommending a variety of useless instruments, difficult to obtain, and more so to use.

The three operations for artificial pupil are *incision*, *excision*, and *separation*. The first is called *corotomia*, and consists in making a cut through the iris, either horizontally or perpendicularly, in the hope that the wound will gape and remain open by the cut fibres contracting. This

* The following case of the absorption of lymph that had been deposited in the pupil, and on the capsule of the lens, will shew how much may be done in such cases without the use of the knife.

Case.—May 6th, 1848. Jane Dunholm, aged 8, of the Township of Kingsley, (C. E.), was brought to me by her father on the above date. Her left eye had been destroyed by a wound from a pair of scissors, and she could only observe the outline of bodies passing between her right eye and the light. She had long suffered from chronic inflammation of this eye.

I found her to be a child of a strumous habit, and on examining her left eye I saw that the pupil was very small, fixed, and filled up with lymph, forming a regular false membrane.

This child attended me daily for about two months, after which time she left me, able to read moderate sized print, and to run about and enjoy herself without any danger.

The pupil acted, and there was only one small band of lymph remaining.

The treatment in this case was fumigating the eye every day with hydrocyanic acid, brushing the eye-lid, &c., with the solution of veratria, smearing round the orbit with belladonna, and taking the quinine and tartarised antimony internally. I used electricity occasionally. And after using the quinine for sometime, substituted for it the ioduretted iodide of potassium.

operation was first performed by Cheselden so far back as the year 1728. The manner in which he performed it, was by introducing a small one-edged knife through the temporal side of the sclerotica behind the iris; he then pushed his knife through the temporal side of the iris into the anterior chamber of the eye, then turned the cutting edge of the knife to the anterior surface of the iris and withdrew it, pressing the knife at the same time against the iris; by this motion he made a horizontal incision across two-thirds of the diameter of the iris, and thus formed an artificial pupil. In his case the cause of the pupil closing was inflammation produced by the operation of couching for cataract.

The second mode of operating, or excision, is called *corectomia*, and consists in removing a piece from the iris to form an artificial pupil. It was first performed by Wenzel, who accomplished the operation by puncturing the cornea with a cataract knife at its temporal side, as if for the extraction of cataract; when the point of the knife had entered the anterior chamber of the eye, he carried it on till he pushed it through the same side of the iris, then brought the handle of the knife back towards the temple, pushing the point towards the nasal side of the iris, where he again pierced it till the point entered the anterior chamber; he then pushed the knife through the nasal side of the cornea, and continued his incision as if for the extraction of cataract till the knife formed a semi-circular flap of the upper part of the iris, which was of course before a flap of the cornea could be formed. After getting thus far with the operation he withdrew his knife, and then introduced a small pair of scissors into the wound, with which he cut off the flap of the iris and removed it.

The third mode of operating, *separation*, is called *cordoalylasis*, and consists in separating the iris from the ciliary ligament; I believe Scarpa was the first that performed this

operation, and it was suggested to him by seeing this effect result from blows on the eye.

He pierced the temporal side of the sclerotica with a straight needle, then pushed it forward behind the iris till its point came to its nasal side, where he pierced it; he then pressed the point of the needle downwards and forwards, towards the centre of the iris, till he detached it at its nasal side from the ciliary ligament, and thus formed an artificial pupil of a triangular shape, its base at the ciliary ligament, and its apex the centre of the iris.

He afterwards recommended the bent needle as the best to operate with.

These are the three operations as they were first performed for the formation of artificial pupil, each operation being called for, from obliteration being the result of inflammation produced by couching for cataract.

They have since been effected in different modes, still they are virtually the same, and though surgeons are constantly publishing some, *so called*, new operation or other for artificial pupil, when we come to read the account we find there is nothing of the sort. If they would only term it a new mode of performing the operation of excision, or incision, or separation, it would be somewhat nearer the fact. For example we read of the term *iridinclesis*, and suppose it to be a new operation from the term, when in reality it is a compound of excision and separation, that is, cutting off the piece of iris that has been detached by separation; or instead of excising the piece, it has been recommended to strangulate it in the wound of the cornea.

There is another operation for artificial pupil, but as it is worse than useless I will merely name it; it is called *sclerectomia*, and consists in making an artificial pupil in the tunica sclerotica.

The operations of *corotomia*, *corectomia*, and *corodilyasis*, are all of equal merit in their places; one being fit in one

case and in another not so, of the three varieties, however, incision is to be preferred where it answers the purpose, and excision is certainly preferable to separation. But where incision cannot be performed, excision can, and where neither of these are admissible, separation should be resorted to. As has been already said, these operations were first performed in consequence of the pupil being closed, and as the result of inflammation produced by couching for cataract; but other causes have since been met with which call for one or other of these operations, and they are accordingly performed in different ways.

In all cases that require the operation for artificial pupil, there is one rule that always holds good, which is, if there be no opacity of the cornea nor any other objection, the pupil should be always formed in the centre of the iris, nearer to its nasal than its temporal side.

Before minutely describing the several operations it will be first necessary to consider the cases that call for the formation of an artificial pupil, and those where such an attempt would be not only useless but dangerous.

Firstly. The formation of an artificial pupil should never be essayed when the person has one good eye; for there is always danger of inflammation following, which the sound eye may partake of, and the result may be loss of both; and even should inflammation not follow, the axis of vision will not be perfect, consequently the patient seeing objects differently with one eye from what he does with the other, nothing could be gained by the operation.

Secondly. The formation of an artificial pupil should never be attempted so long as there is the slightest symptom of inflammation remaining in the iris, for an attack of acute inflammation would be sure to follow.

Thirdly. The operation should never be performed so long as the patient enjoys tolerably fair vision.

Fourthly. Granular conjunctiva, and vascular nebula are decided objections to the operation.

Fifthly. There should be no operation when the whole of the cornea is so opaque, from a cicatrix, that it does not admit any light.

Sixthly. When previous to the obliteration of the pupil, the surgeon is aware that amaurosis exists, or if at the time the appearance of the eye is such as to satisfy him that there is amaurosis, (a conclusion he may safely come to if the patient is not able to discover any light, if there is a varicose condition of the superficial vessels of the eye-ball, attenuation of the sclerotica, the eye-ball having either increased or diminished in size, or its having become either hard and firm, or soft and doughy to the touch,)—if under such circumstances the surgeon operates, he will only disappoint both himself and his patient.

Seventhly. If the anterior chamber of the eye be completely obliterated, and the whole of the anterior surface of the iris adherent to the cornea, success in such a case would be very doubtful indeed.

Eighthly. The result is also very doubtful where there is partial staphyloma, but if there is complete staphyloma, it is useless to attempt the operation.

Ninthly. An operation for artificial pupil should never be attempted, except when the portion of cornea opposite where the pupil is to be made, is clear and transparent.

Some authors recommend that an operation should not be performed if the constitution is deteriorated by scrofula, syphilis, rheumatism, or gout. But if there be no other important disease of the eye present but simple obliteration of the pupil, the constitution must indeed be in a every bad condition to prevent me from giving my patient the benefit of an operation; perhaps the only exception which I should feel inclined to make would be in regard to a patient who was scrofulous and under the age of puberty.

The following are the cases in which the surgeon is called upon to form an artificial pupil :

Firstly. When none of the objections already enumerated exist, and there is closing of the pupil from a deposition of lymph, it does not matter whether there be adhesion to the capsule of the lens or not, or whether the lens or its capsule be opaque or clear; the case is one for operation.

Secondly. The patient should get the benefit of an operation, if none of the objections already enumerated exist, and the closing of the pupil is purely the result of iritis, the inflammation not having attacked other parts of the eye.

Thirdly. If the obliteration be the result of a prolapsus of the iris, caused either by a wound or ulcer of the cornea, the case is also one for operation.

Fourthly. When the pupil is perfect, but concealed by an incurable opacity of the centre of the cornea, which prevents all light from reaching the pupil, an artificial pupil may be made behind that portion of the cornea which remains clear.

Having resolved to operate, there are some cautions to be observed; 1st,—Not to wound the clear part of the cornea; when any part of it is opaque as it would thereby be rendered opaque by the cicatrix that would follow; 2nd,—Not to take it for granted that there is opacity of the lens or its capsule, for operating as though the lens were perfect, would not forbid our continuing the operation and removing the lens if it were found affected.

I have already said that the choice of operation will depend upon the circumstances of the case, and I will illustrate this point by a few examples which will be a guide to the reader.

If the pupil be obliterated in consequence of a prolapsed iris drawing in its fibres, the artificial pupil is best formed by making an incision through a part of the iris and across the fibres, for as soon as the incision is made the wound gapes, and always remains so in consequence of the drag that is kept on it by the part adherent to the cornea.

If obliteration of the pupil be the result of inflammation of the iris, the iris not being adherent to the cornea in any part, and when there is no opacity of the cornea, the proper operation is excision, whether the lens and its capsule be affected or not.

If it be necessary to make an artificial pupil near any part of the edge of the iris, so as to bring it opposite a clear part of the cornea, (the remainder of the cornea being opaque) the proper operation under such circumstances would be *separation*.

I will now proceed to describe the different modes adopted in performing these several operations; but before doing so I would just remark, that I do not think any man can acquire the requisite art or manual dexterity from books or plates. This branch of practical surgery can only be learned by seeing the operations performed.

Corotomia, or Incision.—The position in which the patient should be placed, when an operation for artificial pupil is about to be performed, depends very much upon the operator's own taste; any one position, however, will answer for all. Some like having the patient laid on his back with his head and shoulders supported by a pillow: others prefer having him sit upright with his head supported against the chest of an assistant. I place my patient in an operating chair, so constructed that his head is a little bent back and his body slightly reclined.

The operator will often require to have both hands free, therefore the assistant should be prepared to support the upper, as well as depress the lower lid; and at the same time to keep the eye-ball fixed, which is best accomplished by letting the middle finger of the hand, which depresses the lower lid, rest on the caruncula.

Sir William Adams, finding that the needle with which Cheselden made the incision endangered the separation of the iris from the ciliary ligament, substituted a scalpel or

iris knife of his own invention, which is now found in every complete case of eye instruments. With this knife Mr. Alexander performs the operation of incision, by piercing the cornea at its temporal side, taking care at the same time to keep the flat part of the blade towards the iris. After the knife has traversed about one half of the anterior chamber, its edge is turned towards the iris and pressed against it, then the knife is suddenly withdrawn from the eye with a quick movement, which causes a horizontal incision to be made across the centre of the iris. This is the most simple, and the best way of performing corotomia, when there is nothing more than simple obliteration of the pupil.

When the cause of the obliteration was prolapsus of the iris through the inferior part of the cornea, Beer operated upon it successfully, by pushing a lancet shaped knife through the upper part of the cornea until it reached the anterior chamber of the eye ; he then directed the point of the knife towards the centre of the iris, and pushed it downwards and a little backwards, till it passed through the centre of the iris. When the stretched fibres were thus cut, they contracted and left a gaping wound which formed an artificial pupil. This operation can always be performed with safety, no matter what part of the cornea the iris is strangulated in, by entering the knife in that portion of the cornea opposite to the part containing the strangulated portion of iris.

Jannin performed the operation with a pair of scissors, at least he made the hole in the iris with this instrument. He first, with the cataract knife, made an opening into the anterior chamber through the temporal side of the cornea near to its edge. When the formation of the artificial pupil was to be followed by extraction of the lens, he made the extent of the wound more than a fourth of the circumference of the cornea, but made it less than a fourth if there

was no cataract to be extracted. The scissors he used, to complete the operation, were very small, with one blade sharp and the other one probe-pointed. When the two blades were brought together, their united size was not larger than a common sized probe. After having made the opening through the cornea, he finished the operation with these scissors, by introducing them through the wound of the cornea with the flat sides looking forwards and backwards, when the blades had reached near the centre of the iris, he gently turned them till the sharp point came next the iris, and with it pierced this membrane near to its temporal side ; he then pushed the blades forward towards the nasal side of the eye, the sharp pointed blade being behind and the blunt pointed blade before the iris ; when the points came sufficiently near the nasal edge of the iris, he suddenly closed the blades and thereby made a transverse wound in the centre of the iris. If the lens was to be extracted, he, after piercing the iris in the first instance, pushed on the sharp point of the scissors till he penetrated the capsule of the lens, and then cut both it and the iris with one stroke of the scissors. M. Maunior, finding that the wound in the iris did not gape sufficiently, after making the first cut, turned down the points of the scissors by raising the handles, and made another incision from the temporal side of the first cut, thus forming a triangular piece of the iris, the apex of which was at the temporal and the base at the nasal side of the iris. He found that the little apex curled up and left a good pupil.

I consider that of all these modes of operating by incision, preference ought to be given to those of Beer or Alexander, but I would not operate at all by incision except in such a case as Beer operated in, viz :—obliteration of the pupil from prolapsus of the iris.

Excision, or Corectomia.—When the case admits of this mode of operating, it is certainly preferable to all others.

If there is cataract either to be extracted at the time or couched afterwards, excision is the best operation. If the cornea be clear and the anterior chamber free, whether there be synechia posterior or not, excision is called for.

I have already described the way in which it was first performed by Wenzel; it is a plan now rarely adopted, as that practised by Beer has been found more generally successful. An incision is made with a cataract knife, into the anterior chamber of the eye, through the cornea close to its ciliary margin, which wound must comprise about the sixth part of the circumference of the cornea;—the knife is then to be suddenly withdrawn, and a flow of the aqueous humour follows, with probably a spontaneous prolapsus of the iris.

The next part of the process consists in taking hold of the prolapsed portion of iris, by means of a small pair of forceps, and snipping it off close to the cornea with a pair of sharp scissors, after which the rest of the iris is likely to retract to its natural position, but if not, it must be assisted in with a probe; when it has regained its natural position it will be found to have nearly a circular hole in it. If the iris does not prolapse spontaneously on the withdrawal of the knife, the operator is to pass the small iris hook side-ways into the wound, till its point reaches the centre of the iris, when he is to turn the hook towards the iris, and taking hold of that membrane draw it gently through the wound in the cornea. The operation is to be finished as if the iris was prolapsed spontaneously, except that the hook need not be removed till the piece which it holds is excised with a pair of scissors. Some surgeons prefer taking hold of the iris with a small pair of forceps instead of the hook; I think the hook the more certain instrument of the two. According to Mr. Mackenzie the cornea should be opened at its nasal inferior side. I prefer the temporal side, for two reasons; first, there is less

danger of having the cicatrix opposite to the pupil which should, if possible, be made nearer to the nasal than the temporal side; secondly, if after making the artificial pupil a cataract manifested itself. I could more easily enlarge the wound in the cornea for the purpose of extraction.

When cataract exists Mr. Gibson says that it should be first broken up, and the artificial pupil effected after the irritation produced by the operation has subsided.

Separation, or Corodialysis.—The manner in which Scarpa recommended that this operation should be performed, has been already detailed. It has long since been given up, and the only manner in which it is now done is by combining it with excision, or by strangulating the separated portion in the wound of the cornea.

When, under the circumstances already mentioned, the surgeon determines on forming an artificial pupil in this way, he begins by making a small puncture in the opaque part of the cornea, through which he is to introduce the small iris hook with its flat sides looking forwards and backwards. As soon as the hook comes opposite the clear part of the cornea, he is to turn its points towards the iris, and seizing hold of that membrane is to detach it from the ciliary ligament, by withdrawing the hook and bringing with it the detached portion of iris through the wound in the cornea, when he has his choice of either leaving it strangulated, or cutting the piece off with a pair of sharp scissors; I prefer the latter mode, as there is sometimes difficulty found in strangulating the portion, and very frequently (particularly if the wound in the cornea is large) as soon as the hook is removed the piece recedes.

In the formation of an artificial pupil, accidents are sometimes liable to occur in the hands of the most skilful operator, such as in incision, tearing a part of the iris from the ciliary ligament, or wounding the capsule of the lens, which, if clear would be very unfortunate. The first accident may

also happen in excision, particularly if the patient should start, or the operator's hand be unsteady when the portion of iris to be excised is drawn through the wound in the cornea.

Separation is the most painful of these operations, and it is frequently followed by an effusion of blood in the aqueous humour, which accident may also take place in any of the other modes of operating. This blood, however, though at the time annoying, is of but little consequence, as it is generally absorbed in thirty six or forty hours. Too large a pupil may be formed, and as it has no power of contracting like the natural pupil, it will allow too much light to fall upon the retina: when this occurs it can only be counteracted by some mechanical means, such as wearing goggles, the glass of which should be replaced by a piece of card having a small hole in it. A pupil may be made so small as not to admit sufficient light through it, this also would be an unpleasant result as it might call for a second operation. Another accident that may occur in any of these operations, is for some of the vitreous humour to escape through the wound in the cornea.

After-Treatment.—As soon as the operation is over, the edges of the wound in the cornea should be brought together, and the eye-lids kept closed by means of strips of isinglass plaster stretched from the forehead to the malar bone; a wet piece of lint may then be laid on the eye and the patient sent to bed, where he is to remain as quiet as possible for thirty-six hours, partaking very sparingly of food and that of the lightest nature. At the end of this time the eye may be examined, when if all goes on well the wound in the cornea will be found healed. If inflammation should supervene, the treatment must be the same as that recommended in iritis. The patient must not be kept too long in darkness, but light must be admitted very cautiously at first, and the eyes gradually brought to bear

stronger light. If there has been cataract requiring the removal of the lens, the patient will be obliged to wear convex glasses; this, however, he should not do for one year at least after the operation, and not even then if there is any inflammation of the eye. If the lens has not been removed and is perfectly transparent, according as the patient's sight is short or long, it will be necessary for him to wear either concave or convex glasses.

Treatment of Cataract by Operation.—The treatment of cataract or inflammation of the lens and its capsule, with-
out operation, is treated of in Chapter XVIII, page 349.

The first division that is made of cataract, is into *true* and *spurious*. By the first is meant opacity of the lens or its capsule, or both, producing a dimness of vision. By the second is meant opacity of the parts external to the capsule of the lens, such as opacity of the membrane of the aqueous humour, lymph deposited in the pupil, &c. The latter class have been treated of under their different heads.

True cataract may be divided, with reference to the cause which produces it, into traumatic and idiopathic,—and with reference to its consistence, into hard and soft; this last division is of the greatest practical importance. The next division is in reference to the part that is opaque; when it is the capsule, it is called capsular cataract, when the lens, lenticular cataract, and when both capsule and lens are implicated, this double affection is termed capsulo-lenticular cataract; where the posterior part of the capsule, only is at fault, it is denominated posterior capsular cataract; and when it is the anterior capsule that is opaque it is known as anterior capsular cataract. Another form is what is termed secondary capsular cataract, which is caused by the capsule remaining, and being at the time, or becoming, opaque, after the lens has been removed by absorption or extraction.

These are the only divisions of cataract that I can see any benefit in adhering to.

Some authors have given Morgagnian cataract, on the supposition that the opacity is caused by a turbid state, and an increase in the quantity of the liquor Morgagnia. I very much doubt the existence of such a disease, but even granting that this fluid becomes opaque from any cause, I would consider it in the same light as I would opacity of the aqueous humour, and expect that it would disappear as soon as the inflammation which caused it was removed.

Mr. Mackenzie indulges in a great many divisions and sub-divisions of cataract, but for which I can see no possible practical use. Some writers only announce that another disease is combined with the cataract, and other forms are founded upon their color, curability, &c. In all cases of cataract more or less vision is enjoyed unless it be complicated with some other disease, such as amaurosis, extensive opacity of the cornea, &c. The amount of vision, however, depends upon the part affected, and the stage of the disease. If, for example, the case be capsulo-lenticular cataract, there will be less vision than if it were merely capsular, or lenticular; and if it be lenticular, there will be less vision than if it were either anterior or posterior capsular; for there would be a more opaque body to prevent the transmission of the rays of light.

Diagnosis.—Cataract is a disease which spares neither age nor sex; it is to be found in persons of all ages, from the infant of a few days old, to the old man or woman of a hundred years; but it is more generally found between the ages of fifty and seventy than at any other period of life. Cataract in young persons is generally very rapid in its progress, sometimes forming in a few days, and frequently in a couple of weeks; it is generally capsular, but always soft, whether capsular, or lenticular, traumatic, or idiopathic.

The cataract of old age is slow in its progress, often taking years before it is perfectly formed; sometimes however, it forms very suddenly. It is generally of the capsulo-

lenticular form, and its consistence always hard, whether it be traumatic or idiopathic, unless the old person has had a traumatic cataract from youth, in which case it is found to remain soft even to old age. As a general rule, in old age both eyes are affected, whereas in youth only one eye is the subject of the disease. There are, however, many exceptions to this rule.

In all cases of cataract, the pupil, which is naturally black and shining, loses its color and becomes of a dusky gray, or amber, and sometimes a whey color. If the case is one of the posterior capsular variety, the opacity is tolerably deep in the eye; if lenticular it is nearer the pupil; and if the case is anterior capsular it is nearly in contact with the pupil; but should the case be capsulo-lenticular, then it will appear as if it were nearly in the pupil itself.

If there is no other morbid affection of the eye but cataract, the pupil will always obey the stimulus of light, for which reason a person who has cataract can always see much better on a dark than a bright day, the former allowing the pupil to dilate, the latter causing it to contract. When the pupil is contracted the light falls upon the most opaque part of the lens, viz:—its centre; but where the pupil is well dilated, the light falls upon the whole of the lens, and is transmitted through its most transparent portions. In amaurosis the stronger the light the better the patient sees, provided such light does not give pain.

If cataract is combined with synechia posterior, either the pupil will not contract or dilate, or only a part of it will do so, thus causing irregularity in its shape. If it is complicated with palsy of the iris, the pupil rests immovable; when such is the case it is frequently combined with paralysis, or some disorganized state of the retina, in which case the patient cannot discover any light, and any operation would therefore be useless.

The diseases with which cataract is most likely to be confounded, are glaucoma, or fungus hæmatodes.

The diagnostic signs between them are as follows:— cataract is of a grayish, or whitish, color; glaucoma is of a sea-green; and the opacity in fungus hæmatodes of a shining metallic appearance. In glaucoma and fungus hæmatodes the opacity (at least in the early stage of the disease where there would be any difficulty in diagnosing,) is deeper situated than it is in cataract, and it cannot be seen when the eye is examined in profile, as it can in cataract even when not far advanced.

There are always amaurotic symptoms, such as muscæ volitantes, fiery spectra, &c., accompanying glaucoma and fungus hæmatodes, but these rarely accompany, and are never the result, of cataract. The sight in glaucoma may not be much impaired for years, nor the opacity be greater than at first; whilst in cataract vision generally declines rapidly as the opacity gradually increases in size. The eye-ball in glaucoma, when pressed with the finger, feels firmer than when in a healthy state, whilst in cataract it feels quite natural.

Were it not that I know it to be an every-day occurrence for practitioners to mistake amaurosis for cataract, I should hardly think it worth while to make these observations, for it appears to me that nothing but the greatest ignorance or stupidity could lead any one to fall into such an error, yet I have known men who had no small opinion of their professional ability, allow their patient to become incurably blind of amaurosis, while waiting to operate for what they supposed to be cataract. That many other authors have met with similar examples, is evident from the trouble they take to explain the difference between these two diseases.

The following remarks are made by Mr. Mackenzie in reference to a catoptrical examination of the eye:—

“Having dilated the pupil of the suspected eye by means of the extract of belladonna, the state of the crystalline lens should be examined catoptrically, according to the method recommended by Professor Sanson. The observer and the patient should be placed in moderate day-light; the patient's back is to be turned towards the window; he should be seated so that the observer may look rather down into the eye than upwards; and a candle is to be used which burns steadily, and does not blaze much. When a lighted candle is moved before a healthy eye, at the distance of a few inches, three reflected images of it are seen, viz:—an erect one from the cornea, a second erect one from the anterior surface of the crystalline, and a third, an inverted one, from its posterior surface. The second or deep erect image, which is produced by the anterior surface of the crystalline, is not nearly so sharp as the inverted image formed by the posterior surface.

“The anterior surface of the crystalline, being the segment of a larger sphere than the posterior, and being convex externally while the other is concave; the deep erect image is larger than the inverted one, and appears behind it. The deep erect image even appears larger than the image from the cornea, being magnified by the aqueous humour through which we see it. The inverted image is very minute; we require to move the candle in order to see it. If the candle is moved to the right, the inverted image is seen to shift to the left; if the candle is raised, the inverted image is seen to descend; and *vice versa*.

“In cataract and glaucoma, the superficial erect image which is formed by the cornea suffers no change. Cataract, even at an early stage, obliterates the inverted image, and renders the deep erect one very indistinct. Glaucoma only when much advanced, obliterates the inverted image, while in all its stages, it renders the deep erect one more evident than it is in the healthy eye. Dr. Staberoh has remarked

that in estimating the changes which are observed to occur in the appearances of the images reflected from the eye in its several diseased states, it is necessary to take into account two sources of these changes, viz:—the state of the surfaces which form the images, and that of the media through which we see them.

“The following particulars are worthy of the careful attention of the observer:—

“(1.) In the incipient lenticular glaucoma, or what we may call the first degree of the disease, both the deep erect image and the inverted one are distinct. The deep erect image is rather larger and brighter than in the healthy eye. It is also of a yellow hue.

“With the advance of glaucoma the inverted image becomes larger and of a yellowish color. Its outline becomes sooner diffused than that of the deep erect image.

“(2.) In mean cases, or what we may call the second degree of *glaucoma*, the inverted image is pretty distinct when found near the edge of the crystalline. If it is the right eye which is the subject of examination, and if the observer moves the candle towards the right side of the patient, the inverted image will be seen behind the nasal edge of the pupil; but if the candle be brought slowly in front of the eye the inverted image, as it moves across the pupil, is seen to become less and less distinct, and in some cases is altogether extinguished, till on the candle approaching the patient's left side, the inverted image re-appears behind the temporal edge of the pupil, being again formed by the circumferential portion of the posterior capsule. No such appearance as this is seen in lenticular cataract, a disease which always affects the superficial laminae of the lens in such a way as to prevent the formation of the inverted image by any part of the posterior surface of the crystalline body. The extinction of the inverted image, when the candle is placed directly before the pupil of an eye affected

with glaucoma of the second degree, is owing to a loss of transparency in the kernel of the lens, which suffers, as I have already mentioned, a peculiar degeneration, characterized by dryness of substance and a reddish-brown color.

“(3.) In complete lenticular glaucoma, or glaucoma of the third degree, the inverted image is no longer visible even at the edge of the lens.

“(4.) The deep erect image is better seen in the second and third degree of glaucoma than in the healthy eye. It is large and evident, but its outline is not sharp; so that it often appears like a diffused blaze. The fact that it is more distinct than in the healthy eye, is to be attributed to the reddish-brown kernel of the lens acting as a foil to the image.

“(5.) In the incipient lenticular cataract, the inverted image, though changed neither in color nor in size, is indistinct, and its outline as if washed off. It is extinguished long before the cataract is fully developed; a fact of the greatest importance in the diagnosis which we are now considering. In capsulo-lenticular cataract the inverted image fades much sooner than in mere lenticular cataract, and even the capsule on the superficial substance of the lens, seems to be alone opaque, the inverted image disappears much sooner than we should expect from the apparently moderate degree of opacity.

“(6.) In lenticular cataract, there is merely a general reflection, but no distinct image, from the anterior surface of the crystalline body.

“(7.) If the lens is not in its place, but has been absorbed in consequence of an injury, being removed by an operation, or fallen down into a dissolved vitreous humour, neither inverted nor deep erect image is formed.

“In the diagnosis of incipient cataract and incipient amaurosis the catoptrical test is perfectly decisive, for in amaurosis uncombined with glaucoma the three images are

always distinct, while in even the early stage of cataract, the inverted image is obscure. The diagnosis of incipient cataract and incipient glaucoma requires the catoptrical test to be familiar to the observer, else he may not be able to distinguish, that when the candle is held in the axis of the eye, the inverted image is indistinct in both diseases, but whenever it is moved to one side it becomes distinct in glaucoma and remains obscure in cataract."

The diagnostic symptoms between hard and soft cataract are of much more practical importance than the diagnostic symptoms between capsular and lenticular. Cataract is generally found hard in old age; firm in those of middle age; and soft in youth. A hard cataract, is generally of a dark gray or amber color and the centre only of the lens is very opaque. If the case is one of hard capsulo-lenticular cataract in an old person, its color is generally of a pearly white, and there is very little vision. When the cataract is soft it is of a light gray, approaching to white, and the whole of the lens is opaque; generally speaking, the softer the cataract the lighter is its color. The lens may be, and often is, opaque without the capsule participating in the disease; but it is very seldom that the capsule becomes opaque without a similar condition of the lens being present; this, however, does sometimes occur. When the case is one of pearl-colored capsulo-lenticular cataract, the fringed border of the iris is very visible; when it is lenticular only, and the opacity is confined to the centre of the lens, a dark colored ring is observed, caused by the shadow of the iris falling upon it. Capsular cataract is generally streaked or speckled, and if it be the anterior hemisphere that is opaque, the opacity will be convex; while if it is the posterior hemisphere it will be concave.

In the article on amaurosis the diagnostic symptoms between it and cataract will be again alluded to. Before the surgeon makes up his mind to operate he should be careful,

as far as possible, to satisfy himself that the case is one likely to be attended with success.

If the patient's general constitution is good, and there is no other affection of the eyes present, the surgeon is justified in operating. I say *eyes*, because many authors differ in opinion, as to whether, if there is only cataract of one eye while the other remains perfectly healthy, any operation should be performed or not; some have considered that when there is cataract of one eye the performance of an operation upon it prevents the formation of cataract in the other eye; my experience does not lead me to such a conclusion, but I have very frequently seen sympathetic inflammation set in, in the sound eye, and often terminate with the loss of that organ; and if the operation be ever so successful there is an inequality between the vision of both eyes; these, however, are not sufficient objections, if there are no others, to make the surgeon hesitate to operate upon one eye when it alone is affected with cataract, and the objections are even less if the cataract be traumatic.

Those appearances of the eye which are mentioned as adverse to the operation for artificial pupil, are equally so to that required for cataract.

When none of those objections exist, and the pupil is seen to move briskly according to the light cast upon it, the patient seeing such objects as the fingers held up before the eyes, it is a most favorable case for operation: but even should the pupil act while the patient is incapable of discovering any light whatever, the case will be more than doubtful, as it is probable such a state is owing to some affection of the retina; for it must be remembered that the pupil acts independently of the retina, through the medium of the ophthalmic branch of the fifth pair of nerves, which, as I have already proved, is sensible to the stimulus of light, independently of the retina. Should the pupil be dilated and fixed, in other words should there be paralysis of the iris,

and the patient unable to see the light, the case is hopeless, and no benefit will be derived from an operation. If the pupil be immoveable in consequence of synechia posterior, it is no valid objection to an operation, although the case is not to be considered so favorable. Neither is artresia iridis an objection to the operation for cataract, for it can be performed after the formation of an artificial pupil. One question to be considered is, at what period of the disease ought the operation to be performed? It has been always recommended not to operate until the cataract was ripe, or in other words until the parts become perfectly opaque.

So long as the patient enjoys tolerably fair vision, I would not operate, but would try to produce absorption by those means already enumerated in the treatment for incipient cataract in Chapter XVIII., page 349, under the head of inflammation of the lens and its capsule; but where these means fail, and the patient ceases to discover objects around him, even when he has his back to the light, the operation may be performed. When cataract is the result of injury, the operation should be undergone when all traces of inflammation have disappeared from the eye. If the case is one of congenital cataract, operation must not be delayed on any account; it should at farthest be undergone before teething sets in, for by delay, the capsule which is at first soft, becomes tough; the eyes also acquire that rolling appearance of moving about, from not having any distinct perception of objects; which state is very likely to continue even after the cataract has been removed; delay may also cause the retina to become amaurotic for the want of its natural stimulus, light.

The state of the weather is not sufficiently attended to by surgeons generally; some operate at all seasons, which is certainly wrong;—perhaps the Germans are over cautious in this particular, but they certainly err on the safe side. They will not operate when there is any threatening change

in the weather, such as thunder storms, &c. The most propitious seasons in Canada, for operating, depending of course upon the weather, are the months of April, May, June, September, and October; sometimes the end of June is too warm and the end of October, too cold. The surgeon should always select a period when the temperature preserves a medium range; damp weather is decidedly objectionable.

Another question to be considered, is, should both eyes be operated upon at the same time? Authors vary in opinion upon this point. I am of opinion that they should, if the operation is division; and if no violent symptoms set in after displacing the cataract in one eye, the surgeon may proceed to displace it in the other; but if, on the contrary, violent symptoms set in after displacing the first, it is better to postpone operating on the other. If the patient is strong and healthy, extraction may be performed on both eyes, one after the other, at the same sitting; but as a general rule it is better to wait till all danger of inflammation has subsided, after extracting the lens from the first eye.

Before considering the choice of operation it will be necessary to describe how many modes of operating there are.

There are three operations for cataract; different modes of performing each; and one operation equally as good as the other under particular circumstances.

The first operation ever performed for cataract was *displacement*, of which there are two modes, viz:—*reclination* and *depression*. By depression is meant pressing the cataract with a needle below the level of the inferior edge of the pupil, into the vitreous humour, and thus making way for the light to reach the retina. Reclination is a modification of depression, and consists in turning the lens backwards and downwards into the vitreous humour, and thereby clearing the pupil.

The second operation is *extraction*, by which term is meant extracting or removing the cataract altogether out of the eye. The third mode of operating is *division*, which is to break or tear up the cataract with a needle and then leave the pieces to be absorbed.

As to which of these modes of operating is to be chosen in preference to the other, depends altogether upon the sort of cataract that is to be operated upon, and the general state of the eye and system. It is much to be regretted that men who from their professional standing ought to know better, can be found to write and speak such ridiculous nonsense on this subject. Some men will unhesitatingly declare that the best operation for cataract in every case, without distinction, is division. Another considers reclinacion is the one most to be depended upon; and a third goes so far as to conclude that any surgeon who does not operate by extraction, in all cases indiscriminately, rejects the operation because he is unable to perform it.

If the case is one of hard cataract, the rest of the eye perfectly sound, and the constitution good, the best operation is extraction. The same rule holds good in firm cataract, nevertheless, if the operator prefer displacing it, it is perfectly safe to do so, and is certainly the easiest mode of operating; when I adopt the latter mode, I prefer reclinacion to depression. If the case is one of soft cataract, most decidedly the best operation is division. If it is secondary capsular cataract, after the lens has been removed, division may succeed, but extraction is the surest method.

It is important to consider the accidents that may occur in operating.

There are accidents which may happen in the hands of the most skilful operator, but they arise in most cases, from the unskilfulness of the operator. It is positively astonishing how little some persons seem to value the sight of their fellow men; for very frequently, without well knowing what they

are about, they will insert a knife or needle into this most delicate of organs, cutting and carving as if they were amusing themselves with the eye of a dead ox. I cannot help making these remarks, when so many unfortunate people present themselves to me with their eyes in such a state as to preclude all hopes of doing anything for them. It is not an unusual thing for a person to be led to me, who, upon inquiry, informs me, "I had a cataract upon my eye, and Doctor—— operated upon me, promising to make me see, but I have never had any sight since, and I saw a little before he cut my eye." On examining the eye perhaps I find the iris rent in pieces by the needle of the operator, or the vitreous humour all torn up; or if the case be one of extraction I perhaps discover that the whole of the vitreous humour has been extracted, along with the lens; it is but fair to say, however, that this last accident may occur with the most skilful operator, if the vitreous humour be soft, or the assistant be unhandy and self-confident. Another accident proper to extraction is wounding the iris while making the section of the cornea; it may be punctured when the knife first enters the anterior chamber, or it may be wounded when attempting to counter puncture the cornea; but it is more generally wounded by the iris falling before the knife when it is traversing the anterior chamber of the eye, when, if the section is continued, a piece of the iris will be removed, which will form a false, or increase the size of the natural, pupil, a circumstance that would be rather unpleasant; this accident is caused by the pressure of the aqueous humour upon the iris; therefore the operator before making the counter puncture should let some of the aqueous humour drain off. Another accident that may, but should not occur, is the laceration of the iris with the needle in attempting to open the capsule. It not unfrequently happens that the iris is protruded through the wound in the cornea after the lens has been extracted; to

guard against this accident an effective opening should be made in the cornea, since the prolapsus is caused by forcing the lens through a small opening. When this accident happens, the prolapsed portion of iris should at once be restored to its natural position, before any attempt is made to bring the edges of the wound in the cornea together. The same cause which produces prolapsus of the iris is also likely to occasion a loss of the vitreous humour. In the act of extracting the lens it may be found brittle and may break into pieces; in such a case, the operator should remove the largest portions of it with the scoop and leave the rest to be removed by the absorbents, getting as much of it as possible, however, into the anterior chamber of the eye. When the lens is first touched it may drop back into a soft vitreous humour; then the great probability is that much interference to extract it will be followed by evacuation of the vitreous humours. After extracting the lens, the cornea may fall in against the iris, its anterior part becoming concave instead of convex; here the scoop should be introduced into the anterior chamber, and the cornea pushed outwards, with it, to its proper position, which it will retain permanently as soon as the aqueous humour is re-secreted. On trying to adjust the edges of the wounded cornea, the flap may turn in and prevent the wound from healing; it must be everted with the scoop or small probe, before the lids are closed for the purpose of letting the wound unite. Undue inflammation of the cornea may set in, and on the surgeon examining the eye upon the fourth or fifth day, he may find that the cicatrix has given way, and a portion of the iris protruded; when such is the case, there will be but little use in trying to restore the iris to its natural position; it must, therefore, be either cut off or touched with a pencil of the nitrate of silver. When corneitis sets in, the usual means for allaying the inflammation must be made use of. Some authors state that union of the cornea cannot take

place for the want of sufficiently active inflammation, and that this may be caused in old and enfeebled persons, by deficiency of tone. Although I have never seen it, I have no doubt but that such an event is possible: generally speaking, however, the consequence most to be dreaded is inflammation, which sometimes terminates in suppuration, and total destruction of the eye-ball; this is most likely to follow when instruments have to be introduced frequently into the eye through the flap in the cornea. As to the untoward circumstances likely to occur when extraction is performed through the sclerotica, I will quote the words of Mr. Mackenzie:—"The dangers principally to be feared in extraction through the sclerotica, are bleeding from the choroid, to such an extent as to hide the cataract from view, atrophy of the eye from a profuse loss of the vitreous humour, and amaurosis from the injury which the retina is likely to sustain. I have twice seen capsular cataracts extracted through the incision of the sclerotica. In both cases the loss of the vitreous humour was great, and the eye was left in a state of incomplete amaurosis."

There are also accidents that may happen during and after the operation of displacement. If this operation is attempted through the cornea, which is certainly not the right way, it becomes impossible to put the cataract out of sight, and so place it as to prevent its ascending to its original position, and should it be adherent to the iris, to detach it from that membrane, without lacerating it, will be found nearly impracticable. When it is performed through the sclerotica, which is the proper way, a careless or ignorant operator may, on pushing the needle into the posterior chamber, pierce the iris, and separate it from the ciliary ligament, which will be followed by a flow of blood into the aqueous humour, and the formation of a false pupil; to avoid this, if the needle pierces the iris it should at once be withdrawn, and the operation postponed.

If there are adhesions, the iris may be wounded in separating them, or it may be wounded in passing the needle upwards and anterior to the capsule. Any of these latter accidents are generally followed by traumatic iritis. It sometimes happens that the ciliary processes are wounded, or the iridal artery divided, with the needle, which accident is sure to be followed by hemorrhage; the blood, however, often escapes through the wound, though it sometimes gets into the aqueous humour, completely obscuring the cataract from the sight of the operator, and sometimes requiring to be removed through an opening in the cornea, although, generally speaking, it is absorbed in a reasonable time; if this accident occurs, the operation must be postponed until the blood is absorbed.

The operator by not directing the needle in the proper direction, may pass it into the lens, which will prevent his being able to displace it. He must then turn the needle a few times upon its own axis so as to loosen it in the lens, and afterwards withdraw it by degrees, till he frees it altogether. In displacing the lens it may be pushed through the pupil into the anterior chamber of the eye; such an accident can only be remedied by at once opening the cornea and extracting it. The lens, although properly displaced, may ascend at any time to its original position. Beer has known this to occur after a lapse of thirty years, in consequence of a fall on the head; it rarely occurs, however, after the first fortnight. Its reappearance is generally caused by softening of the vitreous humour, and if the lens is not found to become absorbed, the operation must be repeated. To prevent this accident, Mr. Morgan, surgeon of Guy's Hospital, proposed a new plan of treatment, which is detailed below, under the head of "*Modifications of Displacement.*"

The operator, when attempting to displace the lens, may find it so soft that the needle will go through it; when such

is the case he had better change his original intention and divide it, leaving it to be removed by absorption. The accident of least consequence, that can result from the operation of displacement, is effusion of blood under the sclerotic conjunctiva where the needle has penetrated; this blood is very soon absorbed; a fungous excrescence sometimes shoots from the wound, but it can be removed by occasionally touching it with the nitrate of silver. Violent vomiting often occurs during and after displacing cataract, which is generally caused by some injury to the ciliary nerves, or retina. The worst consequences that are likely to occur from the operation of displacement, are dissolution of the vitreous humour, or amaurosis, from the lens pressing upon the retina: when this last takes place, the lens should be at once raised, passed into the chamber, and extracted: there is no remedy that I know of, for the first. A very unusual, but at the same time possible occurrence, as the result of displacement, is severe internal ophthalmia.

The following are the accidents which may occur during and after the operation of division: any of those which occur in displacement may equally take place in division; there are also accidents peculiar to this mode of operating. The operator may find the cataract so hard that it cannot be divided; if so, (if he be operating through the sclerotica) he should change his intention and displace the cataract. The nucleus may be so hard, as not to become absorbed, after its surface has undergone that process, but drop into the anterior chamber of the eye and there act as a foreign body; this must be remedied by extraction. Another result may be that after the lens has been absorbed, the capsule not being sufficiently torn up, its wounds may unite, and produce secondary capsular cataract,—or if the capsule be not well torn up, its wounds may become healed, even before the lens is absorbed.

When division is performed through the cornea, the needle, instead of going through it, may slip in between its layers, which will compel the surgeon to withdraw the needle and begin the operation again. If the needle is not well formed, that is, tapering towards the point, there will be a loss of the aqueous humour, causing the iris to advance towards the cornea, and the cornea to collapse in a greater or less degree; this accident would make it very difficult for the surgeon to finish the operation.

There is more pain in operating through the cornea than through the sclerotica, consequently, as soon as the cornea is pierced, the pupil will sometimes contract so much that it will be difficult to get the needle through it, to finish the operation.

Conjunctivitis, corneitis, or aquo-capsulitis, or all of these affections, may be produced by operating through the cornea.

The result of division differs very much from that of the other two operations, for in this we have to trust very much to nature, indeed much more than in either of the other two modes of operating; for in these all we want from nature is to heal the wounds that have been made; whilst in the operation of division we require her to absorb the cataract that has been broken up, which process ought to be accomplished in the course of five or six weeks, that is if the cataract is soft, or even firm; but should it be a hard cataract it will sometimes be even twelve months in the absorption, whereas the soft cataract of a child will be absorbed in as many days. That the absorbents may act quickly, it will be necessary to allay all inflammation, for as long as there is inflammation of the eye, there will be no absorption of the broken cataract. It often happens that the operation of division requires to be repeated not only a second but a third and even a fourth time, for as often as

absorption ceases, and any part of the cataract remains, it must be again performed, that is if the absorbents cannot be excited to action, which I have very frequently succeeded in doing by fumigating the eye with hydrocyanic acid, and brushing round the orbit with the solution of veratria. When the capsule is not well divided, or inflammation sets in after the operation, secondary capsular cataract is frequently the result.

Many authors, among whom is Mr. Makenzie, doubt if the capsule is ever absorbed; I cannot help believing that it is, although it certainly takes a much longer time than the lens.

From what has been said of accidents, and other evil results from any of these operations, it will be seen how difficult it is to decide upon the superiority of any one of them over another, and how the choice of operation must depend upon circumstances. Division is certainly the most simple, and less harm is likely to follow when performed by one unaccustomed to operate. It is also certain that persons of an irritable and delicate constitution will bear the operation of division with impunity; while they might be altogether unable to bear either extraction or displacement, but particularly the former. As to the comparative merits of division through the sclerotica, or cornea, it is not very easy to decide; certainly a greater number of accidents may occur when the operation is performed through the sclerotica, but on the other hand there are two great advantages;—firstly, if the operator should be wrong in his diagnosis, and find a firm where he only expected a soft cataract, he can more readily change his first intention and displace it; and secondly, if he finds it to be a hard cataract he can push it forward, into the anterior chamber, and extract it. Dr. Jacob prefers dividing through the cornea, and often as I have seen him operate in that way, I never once knew an accident to occur with him, nor any bad

results that might not equally have followed the other modes of operating.

Previous to any of the operations for cataract the system should undergo some preparation, and in some cases the eye itself.

First. For a day or two previous to the operation the patient should avoid stimulating food and liquors of all kinds.

Second. The alimentary canal should be cleared with a gentle aperient.

Third. When the operation to be performed is either displacement or division, the pupil should be well dilated, either in the ordinary way of smearing round the orbit with the extract of belladonna, or by putting a drop of the aqueous solution of atropine upon the conjunctiva a short time before. This latter preparation has decidedly the advantage over the extract.

If the operation to be performed is extraction, the pupil should not be dilated, as it would render the iris more liable to be wounded, and also to protrude through the wound in the cornea.

Mr. Tavignot, of Paris, recommends salivating the patient with mercury previous to the operations for cataract, and says the operation should be performed as soon as the first symptoms of salivation make their appearance, but that the mercurial action should be continued for two or three days afterwards. His object is to prevent iritis, and keratitis. It appears to me that such a proceeding would be putting the patient in the very worst condition possible, for surely the constitution is in anything but a healthy state when under the influence of mercury. I am glad, however, to find that this practice is generally condemned by ophthalmic surgeons, among whom are Mr. Wilde, of Dublin, Mr. Tyrrell, and Dr. Hays, of Philadelphia.

The position of the patient for operation should be the same in all cases, and the side next to the eye to be ope-

rated upon should be always turned a little towards the window. The general position for the patient is, to sit upon a chair with his head supported by the chest of an assistant, who at the same time keeps him from moving his head by supporting his chin with one hand, while with the index and middle fingers of the other hand, he supports the upper eye-lid, letting the fingers sufficiently far under the edge of the orbit to prevent the eye-ball from rolling upwards. Some surgeons cause the patient to lie on his back, and certainly it is the best way if the operation to be performed is division through the cornea; and also in the case of children, who in addition should be rolled up in a sheet to keep them steady. When I operate upon an adult, I place him in an operating chair sitting in a somewhat reclining position, with his head thrown a little backwards; he is then strapped tight in the chair so that there is no possibility of his stirring; this also gives the assistant the use of both his hands, and he has not to support the patient's head against his chest, which, with persons inclined to be restive, is sometimes not so easy a matter.

When I have a good assistant I prefer his using his fingers to support the lid, to using any speculum; with irritable patients, however, where there is great spasmodic contraction of the orbicularis muscle a speculum becomes necessary; the best kind, of those now in use, is Pellier's, which is a piece of bent silver wire; it is to be found in every case of eye instruments. While one eye is being operated upon, the other should be blindfolded with a handkerchief.

Extraction.—The instruments that are required for this operation, are a knife, scoop, a needle with a bent point and cutting edges, which is generally in the same handle with the scoop; probe-pointed scissors may be required, they should, however, be always at the surgeon's hand. The knife generally used is Beer's cornea knife, the blade of

which is convex on both surfaces, its back continued in a straight line from the handle, and its cutting edge placed at an angle of about fifteen degrees with the back.

The operation of extraction is divided into three periods, —first, making the section of the cornea ; second, opening the capsule of the lens ; and third, extracting the cataract.

Supposing the eye to be operated upon is the left, the patient being seated as already described, and the assistant having the upper lid supported, the operator must depress the lower lid with the index and middle fingers of his left hand, letting the point of the middle finger rest upon the caruncula, to prevent the eye-ball from turning inwards, taking care at the same time to make no pressure upon the eye-ball. He then takes hold of the knife between the two first fingers and thumb of the right hand, in the same way that he would hold a pen, and being thus prepared, standing, or sitting, opposite his patient, he proceeds with the first part of the operation ; by resting the ring and little fingers upon the patient's cheek bone, then directing the point of the knife backwards towards the iris, with its back downwards, with it he pierces the cornea at its temporal side at about the $\frac{1}{20}$ th of an inch from the sclerotica, and about the $\frac{1}{40}$ th of an inch above the lower half of the circumference of the cornea. When the point of the knife enters the anterior chamber, its handle is to be brought backwards towards the temple, so as to bring the flat surface of the knife perfectly parallel with the surface of the iris, and the point directed towards the point of exit on the nasal side of the cornea, which should be exactly opposite the first puncture, and at the same distance from the sclerotica ; he must then cautiously push the knife forwards towards this point, (keeping his eye on the point of the knife and taking no heed of the edge,) and then push it through the cornea, thus making the counter *puncture*, which puts the eye so completely under his command that he may slip down the

finger that has been resting upon the caruncula : he must then complete the section of the cornea by pushing the knife on in the same direction, till it cuts itself out, keeping the handle back so as not to bring the point against the nose. Before the section is completed some of the aqueous humour should be allowed to escape. When the knife has thus cut itself out, forming a flap of the upper part of the cornea, the operator and assistant should remove the fingers and allow the lids to close, the patient being directed to keep quiet. Thus the first part of the operation is over.

It is acknowledged by all surgeons that have ever performed this nice operation, that the main difficulty is in making the counter puncture ; now, the only thing to be attained in this part is to form half, or as much of the cornea as the operator pleases, into a flap. I have invented a knife for this purpose which forms the flap without making a counter puncture, and renders the operation much more simple.* The following is a description

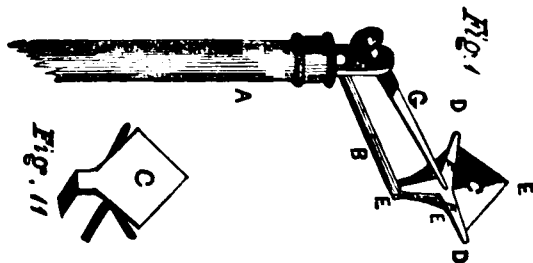

* The wood cut is not put in true perspective, owing to the difficulty of showing the blade of the knife properly by strict adherence to the rule.

- Fig 1. A. The handle about four inches long.
 B. The arm carrying the blade— $\frac{3}{4}$'s of an inch.
 C. The triangular blade.
 D. D. The extreme width of the blade.
 E. E. The extreme depth of the cutting part.
 F. F. The guard which prevents penetration to too great a depth.
 G. G. The screw which secures the guard, and permits its removal to allow the blade to be sharpened.
- Fig 2. C. The back of the blade of the exact dimensions.

of its appearance and size :—It is of a trowel shape, A. the handle similar to the handle of all eye instruments ; B. the curve from the handle to the blade, to give room for the fingers of the assistant in holding up the upper eyelid, and for the depth from the superior edge of the orbit to the globe of the eye ; C. the blade rather convex on the back, and concave on the front, having its cutting part on the front of the edge ; DD. its greatest width, and being nearly equal to the transverse diameter of the cornea ; EE. its depth, and being nearly equal to half the perpendicular diameter of the cornea ; FF. a guard to the knife to prevent its slipping into the anterior chamber further than is intended by the operator. Now if with this knife the upper part of the cornea is pierced at about $\frac{1}{20}$ th of an inch from the sclerotica, and exactly in the perpendicular diameter, and the handle then brought backwards and upwards, it will bring the back of the blade parallel with the anterior part of the iris ; the operator must then push the knife downwards till its point comes near the bottom of the anterior chamber of the eye, at which time its guard will be at its transverse diameter, or nearly so, and the upper half of the cornea will be formed into a flap. That this section may be perfect, the surgeon should be cautious to watch the point of the knife so as to keep it exactly in the perpendicular diameter while carrying it through the anterior chamber ; he must also be sure that its back is parallel with the front of the iris. The operator may then cautiously withdraw the knife, but previous to doing so, he should let some of the aqueous humour escape. After the knife is withdrawn the operator and assistant should let go the lids, and the patient must remain as quiet as possible.

I believe that many advantages arise from making the flap with this knife ; in the first place there is no counterpuncture of the cornea, nor is there any danger of the iris falling before the edge of the knife and thereby becoming

wounded; and again the operation can be performed with the right hand on both eyes, which is a great object with many; I am free to confess that to me it is of importance, for I cannot operate with the left hand with the same certainty as with the right.

To perform the second part of this operation, the surgeon should support the upper eye-lid with the thumb of his left hand, and holding the needle in his right hand direct the patient to look down. The needle having its convexity downwards should in this way be introduced into the anterior chamber of the eye, through the section in the cornea, until it comes opposite the pupil, when its point is to be turned towards the capsule of the lens, which is to be torn up with it, by drawing the needle across it in three or four different directions. The needle should then be withdrawn and the lids closed as before, which completes the second period of the operation.

The third part is performed by gently rubbing the lids with the fingers, over the eye-ball, producing slight pressure upon it; * then when the lid is raised the lens will be seen to extend the pupil, and pass through it into the anterior chamber, and from thence out through the section in the cornea: it is sometimes necessary, however, to remove it out of the anterior chamber with the scoop, which should be introduced the same way as the needle till it is got under the lens, then with it the lens is to be raised up gently till it passes out through the opening in the cornea, when the operator should receive it upon his finger nail and see if it be perfectly whole, and if he find it so the operation is finished. The patient must then close his eyes again and remain quiet for a few minutes, during which time the chair may be turned so as to bring his back to the light. As the patient will expect it, he may be then told to open his eye-lids gently, and try if he can see anything, some object, such as a watch, being at the same time held about twenty

* I have however found it sometimes necessary to make much pressure.

or thirty inches from him. The patient being thus satisfied, should be then directed to close the eye-lids again, after which the operator should gently rub the lids over the eye-ball so as to bring the wounded edges of the cornea in juxta-position. He may then examine the eye, and if he find the pupil clear, the iris not strangulated, and the wounded edges of the cornea in juxta-position, he should close the lids and prevent them from again opening by putting strips of isinglass plaster over them, from the forehead down over the malar bone ; a pledget of lint may then be suspended over the eye from a roller or a night cap. The patient should be then put to bed and ordered to remain perfectly quiet, having the light excluded from the eyes.

This description of the operation by extraction will equally answer if the section is to be made in the lower part of the cornea, excepting that if the knife used is that of Beer, its edge should be turned downwards when making the section. It also answers if the operation is to be performed on the right eye, with this difference merely, that the operator holds the knife in his left hand ; if, however, he is not so expert with his left as his right hand, he may stand behind the patient, and supporting the upper lid with his left hand, operate with the right ; in which case he must trust to the assistant not only to depress the lower lid but also to fix the eye-ball.

In performing this operation some make a section of only the fourth of the circumference of the cornea, others half the circumference ; I prefer the latter, as saving both time and trouble, it being much easier to extract the lens without using force. Some surgeons, after making the counter puncture in the cornea, withdraw the knife and finish the section with a small pair of curved scissors ; I think the plan a bad one ; it is, however, sometimes necessary in a very deep set eye, and also if the operator sees that by continuing the section the knife would come out through the sclerotica.

After-Treatment.—Every thing which might induce inflammation must be avoided. The patient must be kept quietly in bed, if possible in a large room of moderate temperature, and for the two first days he must be cautious even in turning in the bed : his mind must be kept at ease as well as his body ; and his food be simple and antiphlogistic. On the third day the strips of plaster may be removed, and the eye examined, when if the wound be found healed, the eye must be again closed and the plasters repeated. The patient may then be raised up quietly in the bed and allowed to remain so during the day. On the seventh day the eye may be again examined, when if all is found right the patient may keep it open, but covered with a shade. The antiphlogistic plan of treatment must be continued up to the tenth day, when if all has gone on well up to that time, he may be allowed to walk about the room, and after the lapse of fifteen days he may go where he pleases. If during the after-treatment the bowels become confined, they had better be relieved by means of an enema.

Modification of Extraction.—Before describing the various modifications there are for extraction I would remark that I know of none so good as the mode just described, with this addition, that when the capsule is opaque it should be extracted as well as the lens, which can be easily done with a small hook or forceps after the lens has been removed : or, if the eye has already undergone too much handling, the operator may wait until it has perfectly recovered from the effects of the operation, and then either tear up the capsule with the needle, as in secondary capsular cataract, or extract it by making an opening in the cornea the second time. I would prefer tearing it up with the needle, but if at all possible I would extract it in the first instance ; and I conceive the best instrument to accomplish this is a pair of spring forceps with very fine blades and tooth points. I perceive that for this purpose a very ingenious forceps has been invented by L. A. Desmarres of Paris, a sketch

of which is in his very valuable work, *Traité Théorique et Pratique des Maladies des Yeux*, page 649.

Mr. Walker recommended the section of the cornea to be made with a spear-shaped knife, his object being to ensure a large section of that tunic. Mr. C. Bell recommended that the cataract should be extracted through the sclerotica, the opening to be made in the upper part of the eye-ball, the knife to be introduced about the tenth of an inch behind the cornea, and the incision to be of sufficient size for the cataract to pass through it. To remove the cataract he recommended that a sharp pointed probe be passed into the wound and made to penetrate the lens, which could be then lifted out of the eye. This operation has been modified by using different kinds of instruments for the removal of the lens, such as hooks, forceps, &c. I think there are few surgeons of the present day who would operate in this manner; I would not myself. Mr. Scott, senior surgeon to the London Royal Ophthalmic Hospital, recommends a knife for the section of the cornea, with which he says there is greater security to the iris than with Beer's, and not liable to the same objections in any respect. The following extract will show the objects he proposes in the construction of the instrument :

“1. That it shall be of sufficient length to traverse completely the anterior chamber, and divide the nasal margin of the cornea.

“2. That it shall increase in width and thickness from point to heel, enough only to prevent the escape of the aqueous humour, in its transit across the anterior chamber, but that its width shall have no reference to the dimensions of the section that is to be made, as that circumstance I conceive has occasioned all the difficulty of its introduction and the chief danger of the operation.

“3. That it shall be of such a shape and figure that when introduced in the middle of the temporal margin of

the cornea, and carried across the anterior chamber, it shall readily puncture the nasal side of that membrane; and when placed in this situation, the cutting edge shall be so far beyond the pupillary margin of the iris, and opposed to so large a portion of its anterior surface, as will prevent its escape beneath the edge of the knife, to endanger its division in making the section of the cornea.

“4. That when the section of the cornea is thus about to be made, the edge of the knife shall be opposed only to the margin of the section on either side, and not to an extensive portion of its internal surface, whereby its division would be attended with difficulty, as is the case in using Beer’s knife.”

He describes his knife in the following words:—

“The back of the knife describes a sixth part of the circumference of a circle, the radius of which is ten lines. The chord of the arc formed by the back of the knife, is of course ten lines in length, being equal to the radius of that circle. The knife is two lines in width from point to heel. The knife has its convex edge sharp and cutting, and its concave edge the reverse.”*

In the *Medical Gazette*, for October, 1843, page 37, there are two plates given of Mr. Mackenzie’s moveable needle-knife, with a description, and an article from him on its use. I consider the knife a very complicated instrument, and one that is much more difficult to operate with than Beer’s knife, I will, however, give Mr. Mackenzie’s own words:—“It was from Palluci’s moveable needle-knife that I took the hint to have the one made with which I operated upon Wylie. I omitted the groove along the lower edge of the needle, as I thought that was likely to allow the aqueous humour to escape; but in other respects there is no essential difference between the two instruments. The needle part I made broader and longer; broader, so

* Provincial Medical Journal, August 10, 1849.

that transfixing the cornea with it I might accomplish a certain considerable portion of the section;—longer, that there might be less risk of the point of the needle slipping out of the nasal part of the cornea, when I came to push in the knife. Pelluci's knife was convex on the edge; I made mine straight, exactly like Beer's knife, that it might traverse the cornea with the least possible resistance." Then follows a description of the knife, when he continues.—“The following are some of the advantages which appear to attach themselves to such a moveable needle-knife:

“1. It is much easier to traverse the anterior chamber with a needle than a knife.

“2. It is much easier to perform the counter-puncturation of the cornea accurately with a needle than a knife; and how much depends upon counter-puncturating well, every operator is aware. The size and form of the section, depend in a great measure on exact counter-puncturation.

“3. There is less risk of the aqueous humour being evacuated in traversing the cornea with a needle than with a knife.

“4. The cornea being transfixed by the needle part of the instrument, the knife moves along a director with perfect steadiness and certainty, and completes a regular section of the cornea, at a definite distance from its edge.

“The chief disadvantage attending the use of a moveable needle-knife (and which, though it did not occur in the least in Wylie's case, I have experienced on some subsequent occasions,) is, that the pressure necessary for moving on the knife to make the section, is apt to be accompanied with a retrograde movement of the needle, so much so that it slips out of the nasal side of the cornea and allows the aqueous humour to escape. This danger may be partly obviated by having the instrument exceedingly well finished, so that the knife moves sweetly along the needle, and yet is not at all loose or unsteady. It is difficult to adapt

the two pieces of which the instrument consists to one another with perfect accuracy, and yet slide along each other with the necessary freedom."

Displacement.—The preparations necessary for extraction are equally necessary for either *reclination* or *depression*, with the addition that for displacement the pupil should be dilated. The positions of the patient, operator and assistant, should also be the same.

We will suppose the patient properly seated, the assistant having the upper eye-lid supported, the operator the lower lid depressed, and the eye-ball fixed; the eye to be operated upon the left. The operator takes hold of the curved needle between the two first fingers and thumb of the right hand, as he would the knife to extract, and letting his ring and little finger rest upon the cheek bone, the convex surface of the needle being upwards, he pierces with it the sclerotic coat of the eye at the distance of about one-sixth of an inch behind the temporal edge of the cornea, and a little below the equator of the eye. He first directs the needle a little backwards, till it has penetrated about the fifth of an inch in depth, which will bring the lance-shaped part of the needle through the coats of the eye; he must then turn the needle on its own axis, so as to make it perform a quarter of a revolution, which makes its concave surface look forward; while the operator is performing this motion he should bring the handle of the needle a little backwards towards the temple, which will cause its point to come forward to the posterior capsule of the lens, which must be divided by repeated vertical movements of the needle. The operator must then rotate the needle so as to make its concave surface look up, then raise the handle so as to bring the concave surface of the needle under the inferior edge of the lens; the handle must then be brought backwards, and depressed so as to bring the point of the needle into the posterior chamber of the eye, where it can be seen through

the pupil. The point of the needle is then to be turned to the anterior capsule of the lens, and by repeated vertical movements of it the capsule is to be torn into pieces.

Thus far there is no difference between the operations of reclination and depression. If at this stage the operator wishes to depress, he must lower the handle of the needle till he brings the concave surface of the point on the upper edge of the lens where he is to keep it fixed and gradually elevate the handle till he brings it to a horizontal position, when the lens and the point of the needle will disappear beneath the inferior edge of the pupil. During this manœuvre he must not press down the point of the needle with his fingers, but let the sclerotic coat be the fulcrum, and just raise the handle upwards.—If the operator wishes to recline the cataract, instead of bringing the concave surface of the needle to the superior edge of the lens, as he does for depressing, he must only bring it a little above its transverse diameter, having done which, he must bring the handle upwards and forwards, which movement will bring the point of the needle and the cataract backwards, downwards, and a little outwards, into the vitreous humour. After the cataract is thus reclined, the surgeon should keep the point of the needle upon it for a short time, so as to prevent its again rising. He must then depress the handle and raise the point of the needle to the pupil, in which he is to move the needle different times, so as to displace the whole of the capsule, and thereby secure the patient against the formation of secondary capsular cataract. The needle must then be withdrawn from the eye, the operator holding it in the same position he did when piercing the tunics with it. This completes the operation of displacement through the sclerotica.

The reader will have perceived that the operations of displacement divide themselves into four periods, viz:—First, the introduction of the needle through the tunics into the

vitreous humour. Second, the dividing of the posterior capsule of the lens. Third, the breaking up of the anterior hemisphere of the capsule ; And fourth, the displacement of the lens. He must also have perceived that there is but one instrument used, viz :—a needle, the point of which is curved and flat with cutting edges. There are some minute directions given, which it is necessary to explain. The object of having the ring and little finger supported by the cheek bone is to guard against the needle entering too suddenly, and probably too deeply, into the eye.

The needle is to pierce the tunics with its concave surface downwards, to avoid wounding either of the branches of the iridal artery with its cutting edges, which it would be very likely to do if it was entered with its cutting edges upwards and downwards. It is to be entered a little below the equator of the eye, that the tunics may act as a fulcrum for the needle, so that when the handle is brought to the horizontal position, the point of the needle with the cataract, will be sufficiently below the pupil, not to require any direct pressure on the point of the needle to push the cataract down. If the needle is entered too far back from the cornea it is likely to wound the retina, if too near the cornea it will wound the ciliary processes. The reason for directing it in the first instance towards the vitreous humour, is to prevent it from sticking into the lens.

After-Treatment.—The eye-lids must be kept closed for three days with strips of isinglass plaster, and a linen compress pinned to either a roller or night-cap. The patient had better remain in bed for the first twenty-four hours, after which he may sit up, but must keep very quiet.

The eyes may be opened on the third day, but shaded, and the light admitted into the room must be moderate. The patient may look about him so as to see large objects, but he must not examine minute objects, or make such use of his eyes as will cause them to become painful. During

this and for some time after his food should be of a light digestible nature.

Modifications of Displacement.—From what has been already said of displacement through the cornea, I think no surgeon will be inclined to perform it in that way; I will therefore make no further remarks on this mode of operating. Mr. Morgan, surgeon to Guy's Hospital, recommended, and it appears practised, the operation of tapping the eye through the sclerotica, and evacuating a part of the vitreous humour, so that the lens might sink below the axis of vision, in which position he expected it to be kept by a newly formed secretion collecting above it. He was led to perform the operation from having a case in which the lens ascended after being displaced. He gives two cases, in one of which he was successful.

Division through the Sclerotica.—What division is has already been explained. There is only one instrument necessary for operating through the sclerotica, and that is the same needle with which displacement is performed. The operation for division through the sclerotica is divided into six periods. The first, entering the needle into the vitreous humour through the tunics, is in every respect similar to the first period of the operation for displacement. The second period is to bring the needle into the posterior chamber of the eye, with its convex surface looking towards the cornea; this is done exactly in the same way as in the operation for displacement, when the needle is brought into this chamber after first dividing the posterior capsule of the lens. The third period commences by turning the point of the needle to the capsule of the lens, and tearing this membrane in pieces, in the same way as if displacement was to follow; this third period runs into the fourth, which is, to continue this tearing process with the point of the needle till the lens and capsule are cut in pieces. The fifth period of the operation is for the operator to push, with the point of the

needle, as many pieces as possible of the broken lens into the anterior chamber of the eye, there to be exposed to the influence of the aqueous humour. The sixth period is to clear the pupil well of the capsule, with the point of the needle, after which it may be withdrawn from the eye in the same position as it entered, which completes the operation. If at a future time absorption ceases, it will be necessary to operate again, in the same way, tearing up whatever portion of the cataract remains.

If the cataract is fluid, it will pour out into the aqueous humour as soon as the capsule is torn; if it is soft the needle passes through it very easily; if friable, it breaks into pieces; but it is sometimes so hard that it cannot be divided.

After-Treatment.—The after treatment is the same as that already recommended, after the operation of displacement, in addition to which it will be necessary for some time to keep the pupil under the influence of belladonna, for the purpose of preventing the iris from becoming irritated by the broken pieces of the lens rubbing against it. After all danger of inflammation is over, rubbing the lids over the eye-ball, with the fingers, assists in promoting absorption. It is necessary to shade the eyes until the cataract is fully absorbed.

Division through the Cornea.—There is no needle so well adapted to perform division through the cornea as that known by the name of Jacob's cataract needle; its blade is so small that the wound it makes in the cornea leaves no mark; while at the same time it is very strong and of fine temper, so that it is capable of tearing the lens and its capsule into pieces without any danger of its breaking. It is also of such a regular shape as to prevent the possibility of any of the aqueous humour escaping. This needle is made by curving the point of a sewing needle (No. 7) with a pair of plyers, or in any way that is found most conve-

nient, the needle being cold at the time of bending it; out of fifty needles scarcely one may be found of proper temper, but when once the needle is bent it will always preserve the curve. The curved point is then to be ground flat on each side, on a fine hone; this needle is then to be put into a cedar handle, leaving the blade only half an inch long. The handle may be the same length as those in cataract needles generally.

The best position for this mode of operating is for the patient to lie on his back with his head and shoulders raised; the lids may be held in the way already mentioned. The pupil should be well dilated with belladonna.

This operation is divided into three periods, but the second and third may run into one. The first period is the introduction of the needle into the anterior chamber; the second dividing the capsule; and the third dividing the lens. To perform the first part, the surgeon should take the needle, gently, between the two first fingers and thumb of the right hand, and having the eye-ball fixed and the lower lid depressed with the index and middle fingers of the left hand, he must bring its point near the cornea, and about the tenth of an inch from its junction with the sclerotica; the point of the needle should be directed towards the pupil with its flat surface towards the iris. Having it in this position the operator is to strike it suddenly into the cornea, and then push it through that tunic into the anterior chamber of the eye: this is sometimes very difficult, owing to the toughness of the cornea: if the operator, however, does not continue to push the needle steadily through the cornea, he will find it slip in between its layers, which will oblige him to withdraw the needle, and commence the operation again.

When the needle has entered the anterior chamber, the first period of the operation is over, and the surgeon has the eye completely under his control. The point of the

needle is then to be brought to the capsule of the lens, which must be torn up by repeated scratches with it ; this completes the second period of the operation ; and the third is to continue this tearing process with the point of the needle until the whole of the lens is broken up, to accomplish which the needle must be used much more freely than is required for tearing up the capsule ; much caution is requisite to prevent the needle from touching the iris. When the lens is torn up, the operator may withdraw the needle, which requires to be turned different times upon its own axis, to free it from its hold in the cornea.

After-Treatment.—The after treatment is the same as when division is performed through the sclerotica, the most important point being to keep the pupil well dilated. The operation may require to be performed more than once, but no rule can be laid down as to the time that must be allowed to elapse after the first operation ; it should not, however, be attempted while any inflammation exists, nor so long as absorption is going on, producing a change in the cataract.

The following remarks are made by Dr. Jacob :—“While the broken lens lies well in the posterior chamber without pressing on the iris, the operator has reason to congratulate himself, and it is only when he has ascertained that no change has taken place in the cataract, that he is called upon again to disturb it. He should be particularly cautious not to repeat the operation while any trace of inflammation exists.”

The following remarks by Mr. Mackenzie on the use of cataract glasses, I consider to be well worthy the serious attention of the reader :—“The too hasty employment of cataract glasses after the most successful operation, may soon bring the eye to a state of weakness which will render it unfit even for those employments that require but a

moderate degree of sight. No cataract glasses ought to be given to a patient so long as his vision appears to be improving without their use.

“ This generally continues to be the case for several months after the operation. If we allow our patient to use cataract glasses during this period, he will, no doubt, be very glad to find that he can return immediately to his ordinary pursuits; but he will soon begin to observe that he does not see as well as he did, and this he will probably remedy by a new pair of glasses, of greater convexity, and consequently of greater magnifying power than those which he first employed. He will go on in this way, changing his glasses as his power of vision becomes less, till at last he ends in finding none which will enable him to see so well as he did with those which he first employed. On the other hand, if our patient does not begin to try cataract glasses till he has completely recovered from the operation, and the eye has, as much as possible, habituated itself to the absence of the crystalline lens, if he then select proper glasses, and use them for a while only occasionally, his sight will still continue to improve, and his first glasses will probably, if he be an old man, serve him all his life, and if he is a man of 30 or 40, he will not require to change them till he be 50 or 60. He will be able to return to the finest kind of work in which he has been employed, such as drawing, or, if the person be a female, to sewing, and the like. The best test of a cataract glass is, that when placed immediately in front of the eye, it enables the person perfectly to see objects at that distance at which he could see them before he became affected with cataract. If he chooses glasses of too long a focus, for example, of five inches focus instead of four, and three instead of two and a half, he will by and by discover that he sees ill with such glasses, unless he moves them two or three inches forward from his eyes, when he finds that they enable him to see distinctly. In this case he must be

furnished with glasses of shorter focus than those he had at first selected, so that the image of the objects may be formed exactly on the retina. Cataract glasses ought not to bring the object too near, else the patient will be apt to mistake the distance at which it is placed from him, and in trying to grasp it in his hand will fall short of it. When this is the case glasses of a longer focus should be selected. It is said that those who have been short sighted previously to the formation of cataract, can after a successful operation lay aside their concave glasses, without having occasion for any convex ones; and that some require even concave glasses after the operation for cataract, but less concave of course than those which they formerly used. But such statements are probably incorrect. Having operated by extraction, on a man all his life short-sighted, I found for the vision of distinct objects he required the usual glasses of four and a half inches focus. If a patient from whose eye a cataract has been successfully removed, has been originally a little short-sighted, but never used a concave glass, on supplying him with a concave glass after the operation, he will sometimes mention that he sees objects much more beautifully than they ever appeared to him before. In fact he had never seen objects with the distinctness and brilliancy with which they appear to an ordinary eye or to a myopic eye armed with a concave glass."

Staphyloma.—There are different terms applied to this state of the eye, depending upon the shape it presents. Thus, it is called *spherical staphyloma* when the cornea retains its natural form, but is more prominent than it is in the healthy state of the eye. It is called *conical staphyloma* when the cornea in its centre tapers off to a point, forming a tumour; and *staphyloma racemosum*, when the cornea presents several irregular projections.

Staphyloma of the cornea may be either partial or total, or in other words either a part or the whole of the cornea

may be staphylomatous ; if it is only partial, a degree of vision may be left ; if total, vision is entirely extinct. Every description of staphyloma is the result of inflammation, of one kind or other, and as a general rule it is always accompanied in a greater or less degree with synechia anterior ; and very frequently, particularly in adults, the lens and vitreous humour are carried forward, so as to come in contact with the back of the cornea.

Staphylomatous cornea in children is generally solid, for in such cases it is the cornea that becomes thickened, and there is no increase in the size of the anterior chamber of the eye : but the staphyloma in adults is rather a thinning of the cornea ; it then becomes stretched by the pressure from within, thus forming a tumour, and at the same time an increase in the size of the posterior chamber of the eye.

Infantile staphyloma assumes a similar form when the person arrives at maturity. A staphylomatous cornea is generally opaque, but there is sometimes a clear spot on it, through which the patient enjoys some vision. Staphylomas vary in size, some being so large as to protrude out between the lids so as to prevent them from closing, and thus a considerable amount of irritation is produced by the surface of the staphyloma being exposed to external injuries ; others again can be covered by the lids ; but altogether there is scarcely a disease of the eye for which so little can be done, except to improve the appearance of the eye.

Spherical Staphyloma.—In this morbid state of the eye the anterior chamber is obliterated, and the iris in contact with the cornea, but the posterior chamber remains entire, so that in it the aqueous humour continues to be secreted, and becoming accumulated, presses the iris and cornea forwards, and the lens and vitreous humour backwards, sometimes enlarging the whole eye-ball and stretching the sclerotica so as to let the choroid appear through it. The cornea preserves its shape, and is at first thick and tough,

but as the disease advances, the pressure on the cornea excites interstitial absorption, so that it becomes thin, and sometimes so transparent that the patient can discover objects; this raises his hopes, but is an indication to the surgeon that the cornea is about to give way. When this accident occurs, the cornea sinks for a few days, but its former shape and appearance soon re-appear. This description of staphyloma is generally the result of long continued inflammation of the different textures of the eye, which destroys the absorbent power, at least of those absorbents which remove the superabundant aqueous humour, leaving the secretive power perfect. I should remark that although the natural cornea is often affected as described above, yet generally speaking it is first destroyed by abscess, and replaced by a *pseudo-cornea*, which finally becomes staphylomatous.

The following statement, made by Mr. Mackenzie, shows what the iris suffers in this form of staphyloma:—"There is a circumstance regarding spherical staphyloma which merits attention, namely, that when the tumour attains a large size, the iris unable to expand to the same degree as the pseudo-cornea, and its texture much more frail, separates from the choroid, and becomes torn into shreds, so that when we examine the internal surface of a staphyloma after death, or after it has been removed by an operation, we find the iris which adheres to the pseudo-cornea, broken and reticulated; whereas the internal surface of a staphyloma which has not reached a great size exhibits the iris still entire."

Treatment.—For total spherical staphyloma there is no cure, that is, there is no possibility of restoring vision: All that can be done is to remove the unsightly appearance and irritation; and the best mode of accomplishing this is by the operation recommended by Beer; other modes of treatment have been recommended, such as incisions,

setons, escharotics, pressure, tapping, &c.—but none has been found so safe, expeditious, and successful, as the knife. To perform this operation, the patient, assistant, and operator, may be in the same position as if it were a cataract that was about to be extracted, with this exception, that not only should the assistant support the upper lid, but he should also depress the lower, as the operator must have both hands free. The operator must then pass a hook, or a ligature by means of a curved needle, through the staphylomatous cornea; then holding this hook or ligature in his left hand, he has the eye completely under his control. He then takes Beer's cataract knife in his right hand (the eye to be operated upon being the left) and, with its cutting edge directed upwards, pierces the tumour at the temporal edge of its base, below its transverse diameter. In making this puncture, the knife is first to be directed perpendicularly into the staphyloma, then the operator is to carry the handle back till the blade is brought parallel to the base of the staphyloma; he then pushes the knife on in a horizontal position, till its point passes out at the nasal side of the tumour, when he is to continue the knife in the same direction until it cuts itself out. The operator may then, either with the same knife or a pair of curved scissors, cut through the inferior circumference of the tumour, after which the eye-lids must at once be gently closed, so as to avoid, if possible, the discharge of the lens and vitreous humour, and they must be kept in this position by strips of adhesive plaster (or isinglass plaster which is better) and a light compress supported by a roller. To secure the eye from the least motion the good eye also should be hood-winked. For four or five days after the operation the patient should be kept in bed on cooling antiphlogistic diet.

The lids may be opened and the eye examined on the fourteenth day, when, if the lens and vitreous humour have

been preserved, the surgeon will find formed a flat semi-transparent pseudo-cornea, of a gray appearance; and the eye-ball of rather a square shape. This pseudo-cornea becomes, in course of time, completely opaque and firm, of a bluish or brownish color. If after the operation inflammation sets in, which is not very likely, it must be subdued by the ordinary means.

Conical Staphyloma.—This deformity of the eye is generally the result of a large penetrating ulcer of the cornea; it rarely reaches to so great a size as the spherical, in consequence of both chambers of the eye being obliterated, and there being no collection of the aqueous humour. The lens presses with the iris against the cornea, and these are again pressed upon by the vitreous humour, which is generally in a dissolved state. The sclerotic and choroid coats never become involved in conical staphyloma; and when the tumour is once formed, time does not increase its size. It is more rare than spherical, and not being so large is not so unsightly, and is never accompanied with the same degree of irritation.

Treatment.—The treatment is exactly similar to that recommended for spherical staphyloma, except that but a small portion of the cornea is all that is required to be removed; and as the lens lies in such close contact with the cornea it is nearly impossible to avoid removing it along with the portion of cornea and iris that forms the tumour, and the operator may congratulate himself if there is not a loss of some of the vitreous humour also. In operating for conical, as for spherical staphyloma, the surgeon should never go deeper than the base of the tumour, and in every case, should avoid wounding the sclerotica, as to do so would be likely to produce very severe inflammation, and probably convulsions, particularly if the patient be a child. The after treatment is also the same as that recommended for spherical staphyloma. If the case terminates well, it leaves a very well formed eye.

Staphyloma Racemosum.—This state of the eye is the result of several parts of the cornea becoming perforated by ulceration, and the iris prolapsed through those different holes. The aqueous humour being lost there is no protrusion of the cornea; on the contrary, the cornea is generally flat, with raised lumps on it of a black shining color, which lumps are the protruded portions of iris, covered over by pseudo-cornea, which is semi-transparent.

Treatment.—If the whole cornea is in this state, vision can never be restored, but if any part of the cornea is clear, and a part of the anterior chamber remains, there may be a chance of restoring some degree of vision by making an artificial pupil in that part of the iris behind the clear portion of cornea. If the protruded portions of iris be so large as to produce irritation, they may be snipped off with a pair of scissors, and the parts afterwards touched with the nitrate of silver; if they are small, touching them occasionally with the nitrate of silver will be quite sufficient.

Staphyloma Sclerotica.—This is occasionally met with when there is a similar condition of the cornea; but it is also met with, and not very unfrequently, without any such combination. It is generally the result of long continued inflammation, but it may be caused by a rupture of the fibrous coat of the eye, from wound or otherwise.

When it is the result of inflammation the sclerotica becomes attenuated by the process of absorption, and it assumes a dark blue tint, from the choroid coat appearing through it. This thinning of the sclerotica may be either general or partial: when general the whole eye-ball is enlarged, and all the white of it presents the bluish appearance just mentioned. When the thinning is only partial, one point of the sclerotica gives way, generally the anterior, (although it may be the lateral or posterior part,) and a tumour is formed within its concavity, which tumour projecting from the general surface gives rise to a very

considerable irritation. The contents of this tumour are the choroid coat, and very frequently some of the humours of the eye; its size varying from that of a pea to a nut.

When staphyloma sclerotica is the result of a wound of that membrane, it is of course partial, and its situation depends upon the part wounded. It may be caused by the choroid protruding through the wound at the time the injury was received; or the wound may not unite well, and the cicatrix may give way after it has been for some time healed.

Treatment.—The treatment in this disease will depend upon the amount of irritation. In a case of general staphyloma, with irritation, the patient being able to close the eye-lids, I would not operate, as the staphyломatous eye, generally speaking, after some time, becomes in some degree atrophied.

Should the tumour be so large on the eye, as to produce great irritation, when all the other treatment fails to reduce it, recourse must be had to excision. I have, however, succeeded in reducing the eye very considerably, by occasionally tapping it and evacuating a portion of the vitreous humour. The vitreous humour does not re-form so rapidly as the aqueous, and by stimulating and exciting the action of the absorbents, a balance of power is kept up between the secretions and the absorbents, as is the case in a healthy eye. I find the best instrument to tap the eye with, is Beer's cataract knife; with this the sclerotic and choroid coats may be punctured at about the eighth of an inch from the cornea, and a little above the transverse diameter of the eye; if the puncture is made in a depending part of the eye, the wound will not readily heal. After a sufficient quantity of the humour is evacuated the lids may be closed and kept so for forty-eight hours, after which the puncture will be found healed. If this treatment does not produce the desired effect recourse must be had to excision.

If the case to be operated upon is general staphyloma sclerotica, the surgeon may operate in the same way as for staphyloma of the cornea, removing as much of the cornea as is possible without wounding the sclerotica; this is generally followed by an escape of the humours, and the eye becoming perfectly flaccid; the eye-lids should then be closed in the manner already recommended in the treatment for conical staphyloma. If much irritation or pain follows, a poultice will give relief. On examining the eye in eight or ten days after the operation, it will be found sunken, and a fine cicatrix formed where the wound was made.

Should the case be one of only partial staphyloma, a ligature may be passed through the tumour, which will cause an escape of some of the humours, and render the tumour flaccid; then the operator may snip it off with a pair of scissors. The after treatment is the same as for general staphyloma of the cornea.

Synchesis, or Dissolution of the Vitreous Humour.—In treating of inflammation of the internal textures of the eye, and of cataract, dissolution of the vitreous humour was constantly spoken of. Such a disorganized state of the humour is always the result of inflammation; it is incurable, and generally terminates in, or is accompanied by, amaurosis, and very frequently by cataract. We are generally ignorant of the vitreous humour being in this state, till we discover it when operating for cataract, or after death. The eye-ball, sometimes, has a soft boggy feel, but just as often it feels hard, so that neither state would answer as a diagnostic symptom.

Atrophy of the Eye.—This disease is exactly the opposite to staphyloma; it is always the result of inflammation, but generally in those of a strumous diathesis. The eye becomes small, and the cornea flat and dwarfish. I have seen cases where the atrophied eye, compared with the other, looked very like a sixpence when placed by the side of a

shilling. The pupil in this disease becomes contracted, looking like a pin hole. This state of the eye is usually found accompanied with either amaurosis or cataract. If the former, the retina is more or less disorganized, and if it is the latter, operating will, as a general rule, be found useless. I have said it was always the result of inflammation; but it is sometimes congenital, which is a malformation.

Varicosity of the Internal and External Vessels of the Eye.—When there is a varicose condition of the vessels of the eye, it is generally a symptom of something very bad, such as glaucoma or amaurosis; and this condition is always the result of inflammation. If the internal vessels are enlarged very little can be done to remove them. I have, however, found some benefit from the daily application of stimulants to the eye, and when the external vessels only are enlarged I have found decided benefit from this treatment, combined with the infusion of colombo with nitric acid taken internally, or some preparation of iodine. I have also found some benefit from occasionally dry-cupping the nape of the neck.

Amaurosis.—I have placed amaurosis with those diseases which are the result of inflammation; not because it cannot be produced from other causes, but because the general cause is inflammation. By the term amaurosis is meant an obscurity of vision in a greater or less degree, depending upon some morbid condition of one or all of the nervous parts of the eye.

The term *gutta serena* has been applied to the disease from the erroneous supposition that the enlarged black pupil, that so frequently accompanies this disease, was a drop of black fluid.

Causes.—The remote causes of amaurosis are numerous; the immediate are dependent upon some morbid state of either the brain, optic nerve, retina, ophthalmic branch of the fifth pair of nerves, or a general disordered state of the

whole nervous system. When amaurosis is altogether dependent upon the brain, it is generally owing to some state which causes pressure upon the optic-thalmi and corpora quadrigemina, or those parts in immediate connection with the origin of the optic nerve; or any of these parts may be disorganised. When the case is congenital, it may be owing to some defect in the formation of the brain.

The pressure spoken of may be caused by tumors, such as enlargement of the pineal gland, morbid growths on the membranes or bones of the base of the skull, or an abscess forming in the brain. Fracture of the skull, with depression, or effusion of blood, from blows, may be the cause; or effusion of serum as in hydrocephalus. Aneurism of any of the cerebral arteries, congestion of the cerebral blood vessels, &c. Any of these causes may produce pressure in the way I have mentioned, and the result be amaurosis. There are many predisposing causes which may produce these changes in the brain. Scrofula, the general predisposing cause for tumors, abscess and morbid growths in the brain or on the base of the skull. Blows will cause depression of bone or effusion of blood. Effusion of serum may have many remote causes which produce the inflammation preceding such, as intestinal irritation from wounds, diarrhœa, dysentery, hemorrhage from any part of the body &c. &c.; uterine disturbance is another cause.

There are many causes to produce congestion, such as difficult respiration, sudden suppression of perspiration, suppression of menses, suppression of bleeding piles,—in fact suddenly stopping any discharge that the system has been long accustomed to. Liver and heart diseases are a general cause of congestion. Violent exercise, such as blowing long on wind instruments, acts sometimes as a cause. Violent emotions of the mind, or the agency of narcotic poisons, will also produce congestion. It would

be going beyond the limits of this work to mention all the causes which produce cerebral derangement, the result of which might be amaurosis.

When amaurosis is dependent upon the optic nerve, that nerve may be inflamed, disorganised, or congested in any part of its course, or it may be pressed upon and paralysed.

Any cause which would produce inflammation, disorganization, or congestion of the brain, might produce a similar state of the optic nerve. Pressure on it may be caused by tumours in its neuremia, or tumours of any sort in the back of the orbit; it may also be pressed upon by congestion of its blood-vessels, or aneurism of the central artery of the retina. When amaurosis is dependent upon any morbid state of the retina, this tunic is either congested, inflamed, paralysed, or disorganised: the congestion may be either from increased arterial action, or diminished or obstructed venous. There are many causes to produce paralysis of the retina, such as pressure upon it from either the internal or external parts, such as thickening of the hyaloid membrane and increase of the vitreous humour, tumours in the orbit, blows on the eye-ball, &c. Partial paralysis may be the result of a continued loss of the fluids of the body. Any cause that will produce congestion of the brain or optic nerve, may produce the same effect upon the retina. For the causes which produce inflammation and disorganization of the retina, see "Retinitis," page 321.

If amaurosis is solely dependent upon some disordered state of the ophthalmic branch of the fifth pair of nerves, or upon a disordered state of the third, the result is paralysis of the iris in a greater or less degree, and if both of these nerves are paralysed there will be complete paralysis of the iris. When both these nerves are disordered it is generally owing to some disordered state of the lenticular ganglion, but either or both may be disordered without the lenticular ganglion being affected. The causes which produce disor-

ganization, paralysis, or irritation of these nerves, are numerous; they may be disorganized at their origin, from many causes, and they may be paralysed from pressure upon them in any part of their course, from tumours, abscess, aneurism; a very constant cause of paralysis of the iris is a wound of the frontal nerve, which is a branch of the ophthalmic branch of the fifth. Every form of ophthalmia produces irritation of the ophthalmic branch of the fifth, but none leaves such bad effects as where the disease is modified by a strumous diathesis. Irritation of these nerves, followed by paralysis, may be produced by any cause that will debilitate the system or irritate the sympathetic nerve, such as loss of the fluids of the body, intestinal or uterine irritation, liver disease, caries of the teeth, &c.

That paralysis of those nerves, more particularly of the fifth, does produce amaurosis, I believe no one denies, but why it should produce the disease is not satisfactorily proved; nor can it be very easily done until pathology throws more light on the subject; yet I conceive the view I take of it is, to say the least of it, reasonable. When treating of the physiology of these nerves and the physiology of the iris, I endeavoured to prove that the ophthalmic branch of the fifth pair of nerves was sensible to the stimulus of light, independent of the retina; I therefore conceive that paralysis of the fifth is not the direct cause of amaurosis, but that it lays the foundation for the disease in the following manner:—when the ophthalmic branch of the fifth is paralysed, the iris becomes in a similar state, and is consequently dilated and fixed, giving no protection to the retina, so that a greater field of this nervous tunic is exposed to the stimulus of light, than there is in the natural state of the pupil, indeed, a part of the retina receives direct rays which in the healthy state of the iris receives no rays at all.

This light may cause the retina to become inflamed and finally disorganized, or it may produce congestion of its

blood vessels, or even paralyse it. But it may be argued that partial blindness succeeds palsy of the iris, sooner than those changes can take place in the retina; true, but this is owing to the retina being, as it were, confused from the quantity of light, and the rays being scattered which before were collected by the pupil; in fact there is not a perfect picture of objects formed on the retina. I am led to these conclusions, from the fact that patients with paralysis of the iris, (the retina being in a healthy state) can see objects very well, and can even write, and tell what o'clock it is by a watch, when wearing a pair of spectacles, the glasses of which are covered with black paint, excepting only a small spot in the axis of vision about the size of a pin's head, not a ray of light being admitted to the eye, except those which come through what may be called this artificial pupil; and as soon as these glasses are removed they are not able to find their way although they see enough of light. But it may also be said, and with truth, that total blindness often occurs with paralysis of the iris; it will be found, however, in such a case, that whatever has caused paralysis of the iris has produced a similar effect upon the retina.

When a general disordered state of the whole nervous system is the cause of amaurosis, the brain, optic nerve, retina, ophthalmic branch of the fifth, and third pair of nerves, all suffer in a greater or less degree. Debility is the immediate cause of such an effect, and may be produced by hæmorrhage, such as epistaxis, dysentery, bleeding piles, menorrhægie, &c.; other causes are venereal indulgence, masturbation, &c., and again, gonorrhœa, leucorrhœa, diarrhœa, diabetes, oxyluria, or nursing; any of these may act as causes. It is the same sort of blindness that is temporarily experienced when a person is about to faint.

General Symptoms of Amaurosis.—Amaurosis may be either partial or complete, when the former, some vision remains, when the latter, all vision is lost.

The first symptoms which the patient complains of are a partial dimness of vision, with weakness of sight. This is the first stage of the disease, and is called *amblyopia amaurotica*, or amaurotic weakness of sight. If the person afflicted be a clerk, he complains that after writing for a while, his eyes get tired, the letters on the paper become confused, and he writes crookedly; another person cannot read from the same cause: a tradesman finds he cannot do his work as usual; tailors and dress-makers complain that they cannot thread their needles, from a film being over their eyes.

The next stage, which comes on slowly, commences with floating bodies appearing before the eyes, of different shapes, size, and color, and in whatever direction the patient turns his eyes, these bodies start to the other. When they are of a black appearance they are technically termed *muscæ volitantes*, when of a bright, *visus lucidus*.

The next stage is that one isolated spot, termed scotoma, remains fixed, which, if the disease goes on, continues to increase in size, until finally the whole field of vision is covered with it; but before this takes place objects appear in different shapes and forms, sometimes double, which is called *visus duplicatus*, and sometimes crooked, which is called *visus disfiguratus*, and this is generally accompanied with strabismus: sometimes the patient will only see half of an object, and as the disease advances he is obliged to place objects in a particular position, or he will not see them at all.

When the patient is about to become completely blind, and when he has actually become so, there is a vacant expression of countenance, with a moping and bewildered stare, and as he moves he seems apprehensive of danger. In some cases the eye-ball is completely fixed, in other cases turning irregularly in every direction.

Symptoms when the Cause is dependant upon the Brain.—

If disorganization of the brain be the cause of amaurosis, all the symptoms already enumerated will be found to exist, and in addition the patient will complain of pain and dizziness of the head; his whole system suffers, he sleeps badly, and when he does sleep is startled by frightful dreams. The fiery spectra constantly appearing before his eyes add much to his distress. Very constantly there will be paralysis of some of the muscles of the face, particularly the levator palpebræ, producing ptosis; and there is generally a dilated and fixed pupil. In all cases, whether it be from tumours in the base of the brain, chronic inflammation, effusion, &c., the symptoms progress slowly and insidiously, except when there is depression from fracture of the skull, or sudden congestion, in which cases the symptoms present themselves at once: but should the congestion be gradual from chronic inflammation, the loss of vision will be gradual also.

Prognosis.—The prognosis in amaurosis, will depend upon the stage of the disease and the cause which produced it, but it must be always unfavorable if it is depending upon any disordered state of the brain.

Treatment.—The treatment adopted must depend upon the cause of the disease. If there be disorganization of the brain, or tumours of any part of it, or aneurism of any of its vessels, the patient's sufferings may be allayed, but there is no chance of restoring vision when lost from such a cause. If the cause be depression of the brain from fracture of the skull, the depressed piece of bone must be raised. If the case is one of congestion, the surgeon should seek for the cause which produced such a state of the brain, and let his attention be directed towards its removal; he may possibly find it to be the suppression of some natural or habitual discharge, or he may find a chronic inflammation of some part of the brain. If the congestion is great, and the

patient's previous health has been good, benefit may be derived from general bleeding; generally speaking, however, the patient will not bear to lose much blood from the system, but nevertheless bleeding, both general and local, with general antiphlogistic treatment, must be had recourse to, if the congestion is sudden from any violent exercise, violent emotion of the mind, sudden congestion of the liver or lungs, &c. In any such case the greatest benefit will be derived from the slow but continued administration of mercury internally, and counter-irritation to the nape of the neck. If the case is chronic, the liver the remote cause, and the patient of a delicate constitution, much may be done by the internal use of nitric acid, and occasionally passing a stream of electricity through the region of the liver. I must, however, refer the reader to other authorities for information on the subject of disease and injuries of the brain.

Symptoms, When the Cause is dependant upon some Morbid State of the Optic Nerve.—There is no doubt that if the optic nerve was either disorganized or pressed upon, the general symptoms already enumerated would be present; but I know of no particular symptom, that would shew that the amaurosis was completely dependant upon the optic nerve and not upon the retina, unless the brain is also affected.

Symptoms, When a Disordered State of the Retina is the Cause of Amaurosis.—In Chapter XVIII. there is a full account given of inflammation of the retina, with its causes and consequences, &c. When amaurosis is the result of acute retinitis, the retina, generally speaking, is disorganized and covered over with a layer of lymph, which produces all the general symptoms already enumerated, and probably paralysis of the iris from the inflammation having spread to the ciliary nerves. If the iris is not altogether paralysed, it will, on close examination, be found irregular, which is sometimes caused by adhesion, but more generally

by a paralysed state of a part of the iris. The pupil loses its black shining appearance and appears rather of a muddy color; the eye-ball is generally fixed and motionless, and varicosity of its vessels is sometimes found existing. It is not an unusual thing for the acute inflammation to have reached to the iris, causing the pupil to become closed by a deposit of lymph in it.

The history given by the patient in such a case, will be of great assistance to the surgeon in forming his diagnosis. As to a prognosis it is scarcely necessary to say, that where the retina is thus disorganized, and covered over with a layer of lymph, sight is lost for ever.

When, after chronic inflammation of the retina has subsided, we find no improvement in vision, but on the contrary complete or partial amaurosis, the retina is either disorganized, paralysed, or its vessels congested: but paralysis in a greater or less degree, is the common result of a nerve of sense becoming inflamed.

When congestion of the vessels of the retina is the cause of amaurosis, the general symptoms already enumerated will be found present, and in addition, as a general rule, there will be a greater or less degree of vascularity of the whole eye-ball, particularly if it be an obstructed venous circulation, when the face will look blue and cold, and generally there will be a congestion of the whole venous circulation. These symptoms being present or absent, with the cause which produced the congestion and the state of the patient's general health, will be a guide to the surgeon in his diagnosis, as to whether the cause is one of congestion from increased arterial action, or obstructed or diminished venous. For example, if there be sudden congestion from violent exercise, violent emotions of the mind, sudden suppression of perspiration, or of any natural discharge in a person of a plethoric constitution, and this accompanied with a throbbing of the arteries of the neck; reasoning from

analogy, we have a right to conclude that the congestion is arterial : on the contrary, if we find a weak debilitated person, belonging to the lower ranks of life, living in an unhealthy atmosphere, accustomed to work hard and live on bad food, the general constitution injured whether from liquor, debauchery, or otherwise, and having the general symptoms already enumerated, of blue skin, &c., we may safely conclude that the case is one of venous congestion. When amaurosis is the result of narcotic poisons, the case is always one of venous congestion ; but when it is the result of retinitis that has been subdued, I think it more than probable that the case is congestion of the arterial capillaries of the retina. In any of these cases the pupil may be fixed and dilated, or it may act as briskly as ever, but generally it is between these two extremes, that is, the iris acts sluggishly when exposed to a strong light. The color of the pupil affords but little information in forming a diagnosis.

Treatment.—The treatment will altogether depend upon the cause of the congestion and the description of amaurosis. If it be arterial, general antiphlogistic treatment must be had recourse to, such as bleeding both local and general, purgatives and nauseants, and every effort should be made to excite the action of all the secretions, particularly any natural secretion that may have been suddenly suppressed. It is in such a case as this, that the resolvent powders of Scarpa produce such good effects, although in other cases they produce an equally evil result. These powders are made by mixing one grain of tartarised antimony with one ounce of cream of tartar, then dividing the whole into six powders, one of which he recommended to be taken in the morning, another in four hours after, and a third in the evening ; which treatment was to be continued for eight or ten days in succession : but should the powders produce vomiting, he then discontinued them for one or two days, giving an

emetic in the interval. When there is arterial congestion of the retina, much benefit will be derived from applying counter-irritation to the nape of the neck, and giving an alterative course of mercury.

If the case is one of venous congestion, the treatment will be quite different; then tonics must be most depended upon, such as quinine and sulphuric acid, or the nitric acid in the infusion of colombo.* The state of the bowels and liver must be particularly attended to, for which reason much benefit will be derived from an occasional dose of blue-pill. If removal to a dry climate can be accomplished, it will be found of much benefit.

If the cause of amaurosis is congestion of the arterial capillaries, the best general treatment is to administer the oil of turpentine as recommended by Mr. Carmichael for iritis.

The local treatment from which I have found most benefit in all cases of congestion, is fumigating the eye every day with hydrocyanic acid, brushing round the orbit with the eight grain solution of veratria, passing a stream of electric fluid along the course of the nerves, and dry-cupping the nape of the neck. There is one very important thing to be remembered in the treatment of congestion of the retina, which is, that the case must not be soon abandoned but persevered in even when hope seems gone.

Amaurosis from Paralysis of the Retina.—If inflammation, or a blow on the eye be the cause of either partial or complete paralysis of the retina, the general symptoms already enumerated will be found to exist according to the extent of the disease; the pupil will be generally sluggish in its action, and only the one eye affected. If it is not from either of these causes the disease will be slow and

* If in this, or any other disease of the eyes, head symptoms be present and, at the same time it is necessary to give tonics, the best that can be administered is the oxide of silver which may be made into pills with the extract of gentian.

insidious in its progress, there will be no increased sensibility of the retina, no pain or increased vascularity of the eye, but the retina gradually loses its sensibility, the pupil looks black and acts as in the healthy eye, and generally both eyes are equally affected.

Treatment.—If the retina be completely paralysed, it is scarcely necessary to say what little chance there is of its ever recovering: when only partially so, much will depend upon the cause, and whatever the exciting or immediate cause may be, it should, if possible at once be removed; the patient's mind should be kept as free as possible from all anxiety, and he should be permitted to travel and have change of air; he should take tonics, and live upon nutritious diet. The best local treatment is fumigating the conjunctiva with hydrocyanic acid, electricity, and the use of veratria, in such a case the veratria may be powdered, on a raw surface made on the temple by raising a vesication there with the strong liquor of ammonia. As this treatment, however, would be too severe to continue daily, the eye-lids and round the orbit may be brushed every day with the eight grain solution. If the case is very bad, strychnine may be given internally, combined with quinine; I generally give one twelfth of a grain of strychnine with one grain of quinine, made in a pill, twice a day.

Amaurosis from a General Disordered State of the Whole Nervous System.—When, from a general disordered state of the whole nervous system, the retina becomes either partially or completely insensible, the constitutional symptoms will be the best guide to a diagnosis. The motor nerves of the eye often in such cases become paralysed, so that luscitas, ptosis, and a sluggish action of the iris, are generally found present. There will be general debility of the whole system, and a weakness of the circulation, and the other nerves of sense as well as the retina, are in a greater or less degree insensible. It is very seldom in

such a case, that the retina is completely insensible ; on the contrary, the patient often finds his sight temporarily improved after partaking of any stimulant. The general symptoms of amaurosis, as already laid down, are found present. This is a disease very frequently found in young persons who have passed the age of puberty, caused too frequently by the crime of masturbation, a fact which the surgeon should be acquainted with, although one which he should not think of alluding to in the case of a female. If the remote causes be some periodical discharge, or nursing, the disease may be periodical, but I know of no other description of amaurosis that is likely to occur at particular periods, except day, or night-blindness, which is a species of amaurosis.

Treatment.—The treatment must be directed towards the improvement of the general health by every possible means such as change of air, warm clothing, good food, wine, exercise, tonics &c., and above all things to remove the exciting cause. The local treatment consists in fumigating the eye with hydrocyanic acid, and applying the veratria to the eye-lids and round the orbit. Stimulating liniments to the temples and nape of the neck, will also be found serviceable.

Amaurosis from any Disordered State of the Fifth Pair of Nerves.—It has been already explained in the commencement of this chapter, how irritation or paralysis of the ophthalmic branch of the fifth pair of nerves produces amaurosis. The symptoms, in addition to the general ones, are paralysis of the iris, with fixed pupil either more or less dilated or contracted, the patient complains of a dryness of the eye, and not unfrequently we find that the lens becomes opaque ; the conjunctiva losing its nutritive properties, often becomes ulcerated, and, in some degree, insensible to touch. I have seen patients often, draw their fingers across their eyes without producing the slight-

est irritation; and ulceration and sloughing of the cornea take place, without the patient's knowledge so far as feeling was concerned. We often find this form of amaurosis accompanied by a most distressing intermittent neuralgia in the orbit and temple, and if the cause be a wound of the frontal nerve, the neuralgia is often accompanied with a spasmodic twitching of the eye-lids. When the liver, stomach, intestinal canal, or uterus, produces irritation of the fifth through the medium of the sympathetic, it is not unusual to find a similar effect produced upon the third, fourth, or sixth pair of nerves, producing ptosis, and either a fixed state of the eye-ball, or merely a slight motion of it with the cornea turned inwards and upwards.

Treatment.—The surgeon's attention must be particularly directed to the remote cause of the disease. If the disease is in the incipient stage, some crude indigestible food in the stomach may be the cause, the removal of which by an emetic will cure the disease. The state of the iris will require particular attention, for it must be borne in mind, that while there is a dilated and fixed pupil, the retina will be undergoing some change from the quantity of light upon it, probably either congestion, or paralysis, or a chronic inflammation terminating in either of these states. To guard as much as possible against such a consequence, the patient had better wear a pair of goggles or spectacles, having the glasses painted black with the exception of a small spot in the axis of vision about the size of a pin's head; this aperture answers for an artificial pupil. If any disordered state of the digestive or uterine organs be found to exist, every effort should be made to restore them to their proper action, but should there be no such cause present, then tonics should be given, and I think the best is quinine. The local treatment consists in stimulating the ophthalmic branch of the fifth pair of nerves, and thereby exciting it to action; this I think best accomplished by fumigating the

eye with hydrocyanic acid, electricity, and brushing the eye-lids and round the orbit, with the solution of veratria; this should be done once every day, and in addition the patient should have a stimulating liniment, to keep up a slight irritation round the orbit, on the temples, and nape of the neck. I would not recommend that the irritation should be carried so far as to produce either pustules or vesication. Sternutatories will also be found useful, and if the conjunctiva and mucous membrane of the nose be found ulcerated, an eight grain solution of the nitrate of silver should be applied to both parts every day.

When a wound of the frontal nerve is the cause, Mr. Guthrie recommended making an incision down to the bone in the direction of the wound, so as to divide the nerve. I think the purpose is better answered, by frictions with stimulating liniments combined with the means already mentioned. If there be neuralgic pains, much benefit is derived from an occasional purge of croton oil. The teeth should be carefully examined in such cases, and if any are found carious they should be extracted. When the trunk or origin of the fifth pair of nerves is disorganized, or paralysed from pressure upon it, there is *anæsthesia* of all the parts which it supplies, consequently no difficulty in discovering that it is the cause of amaurosis; the conjunctiva, Schneiderian membrane, side of the tongue, integuments of the eye-lids, and all the parts which are supplied with sensation by this nerve become insensible to touch. This state of things is always followed by ulceration of the cornea. If the nerve be disorganized no cure can be expected; but if it be pressed upon, the removal of the pressure will remove the disease; this is sometimes, however, impossible to accomplish, as the pressure is very frequently upon it before it leaves the cranium.

The following cases of amaurosis will shew what a variety of causes there are to produce it, and how the treatment must vary accordingly.

Case 1st.—This was a case arising from injury of the frontal nerve, which produced paralysis of the iris.

January 17, 1846, Cornelius Hays, aged 36, laborer, a man of a quarrelsome disposition; his forehead and eyebrows were all marked with old cicatrices. He was led to me, and stated that he had been in the state in which I saw him for six months, he had been bled, blistered and salivated by Dr. —, but only got worse. On examination I found the pupils dilated and fixed, ulceration of the mucous membrane at the edge of the nose; the strongest snuff or irritation of the nose would not produce sneezing; and no tears came from the eyes, nor did he feel any inconvenience from my passing my finger over the conjunctiva. All the humours of the eye were muddy. After attending two months daily at the Institution this man was able to make his own way about the town, but although he attended for four months longer there was no further improvement. There was then some slight action of the pupil though very slight.

The local treatment was strychnine, and electricity over the course of the extreme branches of the ophthalmic branches of the fifth, with stimulating frictions of liniment of ammonia. I also kept the conjunctiva moistened, by dropping on it every morning the ten grain solution of nitrate of silver. He also took quinine, and other tonics.

Case 2nd.—This was a case of venous congestion of the retina with paralyzed iris; cured after five years standing.

November 5th, 1847. Sarah Doyle, aged 24, a servant, was led to my surgery on the above date; stated that she had been five years blind, and had been under an oculist in New York but received no benefit; she had been bled, blistered, physicked, salivated, &c.

On examination I found that she could not count my fingers when placed between her and the light; that the pupils were fixed and dilated, that they had a bluish cast,

and that both eyes converged. Her face, lips, hands and nails, had a bluish cast.

After six months this girl was able to leave me and again earn her bread as a servant. The pupils acted well, and all that could be observed was that there still remained a slight convergence of the eyes. The treatment I used was daily brushing the eye-lids and eye-brows with the solution of veratria, fumigating the conjunctiva daily with hydrocyanic acid, and, occasionally drawing sparks of electricity from round the orbit, and eye-lids. The general treatment was quinine which she took in large quantities. I should have remarked that this girl's catamenia were always regular.

Case 3rd.—This was one of venous congestion of the retina with very good action of the pupil, though not brisk. September 20th, 1848, Ally Meraun, aged 18; never menstruated; sight so dim for 8 years as to prevent her doing anything but manual labour that did not require much sight; she said every thing appeared to her as if in a very dense fog. She had applied to many doctors but could get no relief. On examination I found that the pupils acted, although sluggishly; they were rather dilated, the iris was dark brown, the color of the pupil was similar to the color observed in the preceding case; her lips, face, hands, and nails also presented the same blue appearance.

After ten days I discharged this girl, able to thread a fine needle, or read small print; in fact her sight was perfectly restored, although there was no appearance of catamenia.

The local treatment in this case was brushing the eye-lids and eye-brows with the solution of veratria. The general treatment was first an emetic, I then gave her a mixture of the sulphate of Bebeerine, ten grains to eight oz. of water, and one grain of tartarised antimony, of this mixture she took one table spoonful three times a day.

Case 4th.—This case was one of arterial congestion of the retina. January 7, 1847, Michael H.—, aged 28. Sight of the right eye had been getting dim for about twelve months; had occasional pain in it, with some slight pain in the head; every object he looked at with that eye appeared as though in a fog, with black motes flying before him. On examination I found that the pupil was dilated, and acted very sluggishly; it was perfectly black, as was also the iris. On looking close, with the help of a magnifying glass and good light, I could observe a slight vascularity round the ciliary ligament.

This man's sight was perfectly restored in from ten to fifteen days. The treatment was, first an emetic and purgative; I then kept up nausea and liquid stools, by a solution of sulphate of magnesia and tartarised antimony; after which I gave him the turpentine mixture, as recommended by Carmichael in syphilitic iritis. For the first week I cupped him three times on the nape of the neck. I also made him give his eyes rest.

Case 5th.—This is a case of amaurosis from a general disordered state of the whole nervous system, Miss——, aged 18, called on me, in consequence of finding her sight become so bad that she was obliged to look very close at small objects to discover them; if she held a book at the ordinary distance from her, the letters appeared as black spots of ink; large distant objects she saw tolerably well, but as if in a fog. Her catamenia were regular, but she had no appetite, and her general health was bad; she was nervous and rather hysterical, very languid, and could not be amused. Her skin was purely white, irides brown, pupils black, very much dilated, and action very sluggish. In four months she was perfectly well. The treatment consisted in making her take air and exercise, retire to bed and rise early, keep pleasant agreeable company, and partake of animal food and a glass or two of wine every day,

and I was most particular in warning her friends not to let her be *alone at any time*.

I brushed her eye-brows and eye-lids three times a week with the eight grain solution of veratria, and made her take one table-spoonful of the following mixture three times a day :

℞ Sulph. quinz. gr. viii.
Tart. ant. gr. ;
Acet. sulph. aromat. gut. xx.
Aquæ font. ℥viii.

Neuralgia of the Fifth Nerve.—Perhaps there is not one nerve in the body more liable to suffer from pain, than that division of the fifth which is distributed to the eye, eye-lids, and circum-orbital region ; and although this neuralgia is not always accompanied by, or is the result of inflammation, still while so much on the subject of the fifth, I consider I am not misplacing the consideration of this disease.

“ This disease was formerly called *tic douloureux* or painful tic ; the former word signifying a sudden catching or convulsive motion, such as is noticed in the face or other parts of some persons, and is as it were a local chorea, and is such as is observed in horses that convulsively bite the manger. Persons with such catchings experience no pain. But when twitchings occur in neuralgia they are attended by pain, and therefore to their name—‘tic’—in this disease the epithet ‘douloureux’ was added.”*

At first the pain is only of short duration, and generally occurring at intervals of ten, twelve, and twenty-four hours, and I have known in one case an interval of seven days ; it is a shooting pain, sometimes only circum-orbital, but often running the course of the branches of the nerve, attacking the side of the nose, the eye-lids, eye-ball deep in the orbit, the cheek and teeth. As the disease continues

* *Cyclopaedia of Practical Medicine*, vol. III, page 381.

the attacks become more frequent, of longer continuance, and the pain so severe as nearly to deprive the patient of his senses, he will suppress his respiration, knit his eyebrows, and keep his teeth, as if convulsively closed ; he describes the pain as sudden, sharp, and stabbing, and will sometimes say, that it is just as if his eye was being rooted out of the socket, and even beg of his medical attendant to root it out if it will only give him any relief. In these severe cases the eye will discharge a great quantity of tears, and the nose a quantity of mucus. When a patient suffers long and severe attacks of this pain, it does actually produce delirium. All this may go on without any inflammation, and as soon as the pain ceases, unless there is delirium produced, the patient is as well as ever until the next attack. This disease is very easily diagnosed so long as there is no inflammation, but it is quite the contrary when it is accompanied by inflammation, and may very easily be mistaken for sclerotitis ; I have myself met with one case that for a time I considered to be general ophthalmitis.

When it is accompanied by inflammation the redness of the eye does not disappear on the cessation of the pain, but it becomes paler, becoming again florid when the pain sets in ; and the pain is often brought on before its time by chewing, blowing the nose, or even touching the skin of the eye-lids, which is generally hot, red, and swollen during the attacks of pain, and often remains swollen after the pain ceases. In addition to these symptoms there will be others present, such as amaurosis, deafness, &c., if the disease is produced by organic changes within the cranium.

If there is one disease of the eye more than another that deserves the name of intermittent ophthalmia, it is where neuralgia of the ophthalmic branch of the fifth pair of nerves is accompanied with inflammation.

It is very difficult to say what is the proximate cause of neuralgia ; pathological anatomy is by no means satisfac-

tory. The pain may be sympathetic, caused by some disordered state of the digestive organs, or some irritable state of the uterus. I have found weakly women, when long nursing, suffer from this disease and recover on weaning the child. Wounds of the frontal nerve will sometimes produce it; so will a cold blast of air on the eye, and of course any organic change that will produce pressure on the nerve in any part of its course.

Treatment.—The surgeon must be guided in his treatment by the patient's general constitution, which generally speaking is very delicate, which is quite sufficient cause for the avoidance of antiphlogistic treatment. Some recommend the application of leeches where there is inflammation, but I have never seen much benefit result from their use; mercury I have found to aggravate the disease; tonics, stimulants, anodynes, narcotics, counter-irritation, electricity, warm and cold baths, &c., have all been recommended. The tonics that have been most used, are the carbonate of iron and the sulphate of quinine. The anodyne narcotics, morphine, stramonium, belladonna, aconita, &c.; Strychnia and veratria have also been applied to the parts. Purg- ing with croton oil has been strongly recommended. When I cannot find any immediate cause to remove, such as nursing &c., I first give a purge of croton oil, from half a drop to a drop, I then give a five grain dose of quinine, to be taken a little before the time the attack generally comes on, and an eight ounce mixture containing eight grains of quinine, a table-spoonful of which is to be taken every eight hours, after the first five grain dose. This treatment, with brushing the eye-lids and round the orbit every day with the solution of veratria, I generally find performs a cure, whether the case is accompanied with inflammation or not.

Ossific deposits in different parts of the Eye.—Pathological anatomy fully proves, that many parts of the eye become

ossified as the result of long continued inflammations. In such cases the eye is generally atrophied ; but unless the deposit is in the cornea, or aqueous humour, where it can be seen, there is no diagnostic sign by which it can be known that any of the parts that are hidden from view have become ossified. And this is not of so much consequence, for even should the surgeon be able to diagnose it, he can do nothing towards effecting a cure. I once extracted a cataract that had ossific deposits in it.

CHAPTER XX.

PARTIAL AND GENERAL ENLARGEMENT OF THE EYE.*

Hydrophthalmia, or Dropsy of the Eye.—Dropsy of the eye like dropsy in other parts of the body, may arise either from an increased action of the secretions, or a diminished power of the absorbents. I think, generally speaking, when the eye is the seat of the disease, it is owing to the latter cause, for it has been found that diminishing the power of the secretions does not tend so much to a cure, as increasing the action of the absorbents does. Dropsy of the eye is of three varieties; the first depending upon the aqueous humour, the second upon the vitreous, and the third upon both those humours. When the case is a preternatural accumulation of the aqueous humour, the cornea becomes dim, the anterior chamber of the eye enlarged, and the iris loses its mobility; there is a feeling of heaviness and tension in the eye-ball but no actual pain. As the disease advances the cornea expands to three or four times its natural size, and its appearance becomes more dim and muddy, owing, however, to the turbid state of the aqueous humour more than to any loss of transparency in the substance of the cornea; the iris becomes of a dull color, and completely motionless, but the pupil neither becomes dilated nor contracted. As the eye-

* The following remarks I take from the Dublin Quarterly Journal of Medical Science, No. 10, page 469.

"*Megalophthalmos*, or preternatural enlargement of the globe.—We are indebted to Mr. Fleming for a case of this description which fell under his notice in one of the temporary fever hospitals. The boy, now seventeen years of age, has brown hair, and dark hazel eyes. The right eye is natural in every respect; the left is nearly twice the size of the right, and very defective in vision, but perfectly natural and to all appearance healthy in its coats and humours. From all its parts being in proportion to one another, it presents one of the best instances of pure buphthalmia, or congenitally enlarged eye, which we have yet seen or read of. The pupil is perfectly sensible to light, and the lachrymal appendages normal."

ball increases in size its motions become impeded, the cornea gets a hard feel, and the anterior part of the sclerotic acquires a bluish tint; with all this tension the cornea seldom gives way, but the iris will become ruptured and absorbed, and finally the eye become atrophied.

Vision at the beginning of the disease becomes presbyopic or far-sighted, but this is soon followed by amaurotic weakness, which if the disease continues, terminates in blindness; if the disease, however, be stopped in its first stage the long-sightedness may remain without its terminating in amaurosis.

This form of hydrophthalmia is very likely to terminate in general dropsy of the eye; but even under the most favorable circumstances the chance of cure is very doubtful; if at the beginning, however, the primary cause is known and the patient's constitution is good, some hopes may be entertained of success, but if vision is once gone its restoration is out of the question.

Treatment.—The treatment will depend very much upon the primary cause; the constitution must be well attended to, and if found in a weak state tonics must be given; indeed there is hardly a case of this disease in which it is not found necessary to give tonics. If the cause be an injury, and the constitution good, digitalis and quinine combined with calomel, should be given until the system is affected by the latter. If there be suppression of any periodical discharge, it must be reproduced by the ordinary means; if there be sudden suppression of an eruption, much benefit will be derived from counter-irritation to the nape of the neck. When the disease continues without any mitigation, Beer recommends the evacuation of the aqueous humour, by opening the inferior part of the cornea with a lancet; Under such circumstances I do not see why some of the aqueous humour should not be evacuated, but I would prefer using a flat cataract needle to a lancet, and would rather

open the side of the cornea than its lower part, to give the wound a better chance of healing.

When there is a preternatural increase of the vitreous humour, the characteristic symptoms of the disease are, an increase in the size of the eye-ball with but very little additional increase in the convexity of the cornea; the anterior chamber of the eye becomes small, and finally obliterated by the iris being pushed forward against the cornea: the sclerotica becomes of a bluish color, the eye-ball becomes hard, impeded in its motions, and finally altogether motionless; the iris undergoes no change in color, but the pupil becomes very small. From the commencement of the disease there is pain in the eye, which daily increases until the side of the head, neck, and teeth partake of the pain so as almost to deprive the patient of his senses, and making him constantly call upon the surgeon to puncture his eye. Vision is at first myopic or short-sighted, but it soon diminishes, and is at last totally destroyed. The general health suffers much, and from the beginning the patient is deprived of sleep and appetite. The prognosis in such a case must be very unfavorable, indeed it will be doing much in such a case to save the patient's life.

Cause.—The only cause given by Beer for such a disease, is an unhealthy constitution having in it a serofulous or syphilitic taint.

Treatment.—The most important point is to improve the patient's general health, local treatment being of very little use. The only thing that can be done when the case gets very bad, threatening the patient's life, is the treatment recommended by Beer, viz:—to make a section of the cornea as if about to extract a cataract, and evacuate the aqueous humour, crystalline lens, and a part of the vitreous humour; then allow the eye to collapse,

When there is an increase of both the aqueous and vitreous humour, the case is termed general dropsy of the eye.

There will be a combination of the symptoms already described in the two preceding forms of this disease, but they will be much more severe. Both chambers of the eye are enlarged, the iris generally becomes tremulous, and seems as if situated further back than is natural. The constitutional symptoms are very severe, the patient being often deprived of his senses. Beer saw such a case produce caries of the bones of the orbit.

Causes.—The immediate causes are very obscure except when the disease is produced by either injury or inflammation. Beer considered scrofula a predisposing cause.

Treatment.—If the treatment recommended in the preceding forms fails to give relief, the contents of the eye must be evacuated.

Any form of hydrophthalmia may be the result of either inflammation or injury, or it may occur without any very visible cause. According to Beer it is seldom entirely a local disease, but is generally combined with an unhealthy state of the constitution.

Conical Cornea.—The convexity of the cornea varies in different individuals; it sometimes projects so much, in the form of a cone, as not only to diminish but to quite destroy vision. The point of the cone is generally in the centre of the cornea, but it is sometimes situated on the side of it. Authors formerly considered the disease as a thickening of the cornea, but pathological anatomy has shown, that it is a thinning of the cornea in that particular part which forms the cone, and that this part yields to the pressure of the aqueous humour.

This state of the eye is rarely, if ever, accompanied by inflammation. The patient at first becomes short-sighted, which causes him to partially close his eyes when engaged in examining objects. As the disease advances he sees objects multiplied, or will not see them at all except when they are held laterally to the eye. If at the commencement

of the disease, the surgeon looks straight into the eye, he sees no change in the shape of the cornea, but if he examines the eye in profile, the cone will be observable shining like a diamond. At first the cone is perfectly transparent, but after the disease has continued for a long time, it becomes opaque. The disease sometimes begins in one eye and after a time appears in the other.

Cause.—The cause of this disease is very obscure; it has been met with in every stage of life, but is said to be more frequent in women than in men. Dr. Ammon met with congenital cases of it.

Treatment.—The only treatment that has been found to produce any benefit, is giving the eyes rest, prescribing tonics, and attending to the general health; benefit will also be derived from the application of stimulating liniments round the orbit. Evacuating the aqueous humour, and using pressure upon the cornea have been practised, but with very little benefit. Mr. W. W. Cooper was more successful than others in this treatment, by means of an apparatus that he invented for keeping up long continued pressure upon the eye without producing irritation, at least it produced less irritation than any previous means that had been tried; it was not, however, so successful as to encourage its use. The apparatus was an air-cushion acted upon by a spring after the manner of a truss.*

Sanguinous Effusion into the Eye.—Blows or wounds of the eye are very frequently followed by an effusion of blood into the aqueous humour; but this effusion sometimes occurs in very sound eyes without any such causes, and has been known to occur periodically in persons of a weak constitution, and sometimes to be brought on by violent exercise. The disease is termed apoplexy of the eye; it is sometimes, but not generally, accompanied by pain, and a degree of inflammation.

* Dublin Quarterly Journal of Medical Science, No. 10 page 491.

Treatment.—I never saw a case of this spontaneous effusion of blood into the aqueous humour, but it appears by the cases on record, that nature left to herself always performed a cure in time, and that no treatment local or general tended to hasten it.

Non-Malignant Tumours of the Eye-ball.—It is not a very unfrequent occurrence, for the eye-ball to become enlarged by tumours forming in different parts of it, and these tumours not of a malignant nature. They may be situated in any part of the eye, and be composed of blood, organized lymph, albumen, scrofulous tubercles, or the tumours may be encysted; these last are generally met with in the interior of the eye, scrofulous tumours in the sclerotica, cornea, or iris. When any of these tumours form in the deeper parts of the eye, they are sometimes mistaken for fungus hæmatodes, a mistake which is dangerous, for it leads to a painful and useless operation, viz:—the extirpation of the eye-ball.

Causes.—Injuries and inflammation have been known to act as exciting causes in producing these tumours, particularly if the person be of a scrofulous diathesis.

Treatment.—I would first give calomel and quinine until the patient's system was brought under the influence of the former; then give the ioduretted iodide of potassium, using at the same time stimulating friction round the orbit, and counter-irritation to the nape of the neck. If this treatment fails to lessen the size of the tumour, or mitigate the patient's sufferings, the only remedy that can be resorted to is the knife, when it will be impossible either to prevent the loss of much of the humours, or to preserve the shape of the eye, unless the tumour is superficial, and then also I should always use the knife, although it might be removed by the constant application of the nitrate of silver. The following case is given by Mr. Mackenzie, in his work on the eye:—"A lady was affected with considerable pain in

one of her eyes, which presented the appearance of a small vesicle pushing into the anterior chamber from under the ciliary margin of the iris behind the lower edge of the cornea. The vesicle gradually increased, separating the iris more and more from the choroid, and the pain became severe. I punctured the vesicle, or encysted tumour, with the iris knife, through the cornea. A minute quantity of fluid was discharged from the cyst, which immediately contracted so much that it was no longer visible. The pain was removed; the wound made in the cyst healed, it filled again with fluid and again appeared in its former situation, but larger than before; I punctured it a second and a third time, at intervals of six and eight weeks; after the third puncture it did not fill again. The iris returned to its natural place; the pain ceased entirely; and vision was preserved."

I consider the above one of the most interesting cases of the kind on record, and I have no doubt but that it was the aqueous humour getting into the sac that produced inflammation, causing it to contract, and its cavity to be finally obliterated.

CHAPTER XXI.

MALIGNANT AFFECTIONS OF THE EYE-BALL. EXTIRPATION OF THE EYE. ADAPTATION OF AN ARTIFICIAL EYE.

There are three malignant affections of the eye-ball, viz :—*Scirrhus*, *Fungus Hæmatodes*, and *Melanosis*. The first is a disease found in old age ; the second is generally confined to youth ; and the third, to persons of middle age.

Scirrhus.—So great was the similarity between this disease and fungus hæmatodes, that Scarpa and many others extirpated the eyes of young persons, under the supposition that it was under this disease they were labouring, when in reality it was fungus. It was Wardrop who by his pathological researches, showed the distinction between the two diseases. Females are more liable to this disease than males, and it is at that change of life when women cease to menstruate that it most generally makes its appearance, and is in most cases the result of long continued inflammation of the eye. Its chief characteristic symptoms are, that it generally commences as a hard carcinomatous growth approaching to the consistence of cartilage, on the conjunctiva or lachrymal gland, where it may continue for a long time without affecting the neighboring parts, or becoming ulcerated.

It is accompanied with pain in the eye and head, and dimness of sight sets in early, which is soon followed by a total loss of vision ; the cornea becomes opaque and shrunken, the sclerotica a dirty color, covered with varicose blood-vessels. As the disease advances the pain becomes of a burning lancinating description, and the slightest touch of the tumour produces a flow of scalding tears, which causes great irritation ; the subconjunctival cellular tissue next becomes affected, the eye-lids swell, and the eye-ball

becomes immoveable; the tumour next ulcerates, and the surface of the ulcer discharges an acrid matter: the disease then spreads very rapidly, until one part after another is destroyed. The pain and irritation increase, the glands of the neck become hard and painful, and fever supervenes, under which the patient sinks rapidly.

Scirrhus is more liable than fungus to be propagated through the absorbents; it is of a firmer consistence and less sparingly supplied with blood-vessels; it rarely grows to so large a size; its progress is generally slower; it becomes more firmly adherent to the surrounding parts; there is very seldom interstitial hemorrhage; cancer is generally superficial—fungus more generally in the bottom of the eye.

Prognosis.—If the eye be extirpated in the early stage of the disease, life will be saved by it, but when once the tumour ulcerates and the disease spreads to the surrounding parts, nothing can be done but to try and alleviate the patient's sufferings.

Treatment.—The only proper treatment is extirpation of the eye-ball and all the soft parts in the orbit, and this should be done in the early stage of the disease. If the disease is too far advanced, or the patient is unwilling to submit to an operation, his sufferings may be alleviated by keeping his bowels regular, living quietly on mild nutritious diet, and fumigating the eye with narcotics. It will be also found necessary, particularly in the advanced stage, to give some preparation of opium.

Fungus Hæmatodes.—Various names have been given to this disease, viz:—*Medullary sarcoma, encephaloid tumour, soft cancer, spongiæd inflammation.*

When this disease attacks the eye, it always begins in that part of the retina which is pierced by the optic nerve. If the surgeon sees the eye in the early stage of the disease, he will observe something in the posterior chamber resem-

bling a piece of polished iron ; that the iris has lost its natural color, and the pupil is fixed and dilated. As the disease advances the shining body presents an amber color, and as the tumour is then advanced forwards, the central artery of the retina will be seen running over its surface. The disease may remain in this stage for months, or even years, without making any further progress, and it is at this stage that it is sometimes mistaken for cataract, but the irregularity of the tumour should be a sufficient symptom to enable the surgeon to diagnose between it and cataract. Up to this time, generally speaking, there is not much, if any, pain or inflammation, but from the very first there is total blindness, and the patient suffers much from head-ache. When after this stage the tumour begins to advance towards the iris, its progress is very rapid, generally destroying the whole eye in a few weeks, and the fungous tumour, which had occupied the place of the vitreous humour at first, will now, having destroyed the lens, iris, and cornea, fill up the orbit, and in a very short time become too large for that cavity. Before the cornea gives way to the pressure of the tumour it stretches to double its natural size, the sclerotica becomes of a dark blue or leaden color, and the whole eye-ball, losing its natural figure, presents an irregular appearance. Matter then collects between the tumour and the cornea, and the conjunctiva becomes swollen and œdematous. During this time the patient's sufferings are very great, the pain in the head and neck producing high fever, and sometimes delirium. The tumour may make its way either through the cornea or the sclerotica, but it is more generally through the former ; when the cornea ulcerates and bursts, a fœtid bloody fluid is discharged, and the fungus shoots out. If it is the sclerotic coat that gives way the tumour for a time is covered with conjunctiva ; this, however, soon gives way, when the tumour is exposed ; its surface presents an irregular appearance, and is of a dark red

color, being generally covered with coagulated blood. The slightest irritation causes the tumour to bleed profusely; the surface of the tumour next sloughs, which is attended with a sanguineous foetid discharge, which excoriates any part of the integuments over which it passes. After the eye bursts there is some temporary relief to the patient, but his sufferings soon set in again with renewed vigor, disordering all the functions of the body, till finally he expires either from hectic fever, or loss of blood, or he becomes comatose and dies in convulsions. The patient rarely lives for the tumour to dilate and destroy the bones of the orbit; but it is not unusual for the absorbent glands under the jaw and about the parotid gland to become contaminated, and for the skin over them to burst, thus producing a sloughy ulcer.

Cause.—The exciting cause of this disease is very obscure; some have attributed it to blows on the eye, but this I think is very doubtful. The subjects of it are generally children of a scrofulous diathesis. It rarely if ever occurs in adults.

Diagnosis.—I have already given the diagnosis between this disease and cancer, and between malignant and non-malignant tumours. If any doubt should exist as to the character of the tumour, Mr. Travers recommended that a section of the eye should be made, when if the disease was malignant there would be only a small discharge of blood, and the eye-ball would remain firm,—but if it was non-malignant, a discharge of discolored matter would take place, when the globe would collapse and a cure be effected.

Treatment.—Benefit has been derived from mercury when given in the early stage of the disease. The following statement is made by Mr. Lawrence:—"I would not, however, represent to you that the state of a patient with fungus hematodes of the eye is absolutely hopeless; by the

long continued use of mercury the progress of the disease has been arrested in a few instances, and the morbid deposition has been removed. I had under my care a case of this kind, in which I saw the morbid deposit in its early state, in which the globe afterwards enlarged, and the lens became opaque. The employment of mercury, persevered in for many weeks, completely arrested the malady; and the patient, after remaining well for years, died of affection of the head, excited by development of disease in the brain.”* As a general rule extirpation of the eye-ball has been objected to in this disease, but when all other treatments failed, I think it might be as well to give the patient the chance of the operation.

Pathological Anatomy.—The appearances on dissection are far from being uniform; some cases have been found where the sclerotic and choroid coats did not partake much in the disease; in other cases the whole eye-ball was gone and all the soft parts of the orbit, leaving nothing remaining but a fungous mass; even the bones of the orbit have been found diseased, and sometimes the brain. It is not a very unusual occurrence to find the same disease existing in some of the other organs of the body, such as the lungs, kidneys, liver, &c., and if the patient is a female, the uterus. The following is from the pen of Mr. Wardrop:—“On dissection, a diseased mass is found extending forwards, from the entrance of the optic nerve, the vitreous, crystalline, and aqueous humours being absorbed. The retina is annihilated, and the choroid coat propelled forwards, or quite destroyed. The tumour seems to consist of a sort of medullary matter, resembling brain. The optic nerve is thicker and harder than natural, also of a brownish color, and destitute of its usual tubular appearance. In other cases the nerve is split into two or more pieces, the interstices being filled up with the morbid growth.”

* Dublin Quarterly Journal of Medical Science, No. 10, p. 504.

Melanosis of the Eye-ball.—This is a disease of very rare occurrence; it is met with generally in persons of middle age, and has no tendency to be propagated through the absorbent organs; the consistence of the tumour is soft, in a thin cellular septa; its color is nearly black, and it generally attains to a large size; no blood vessels have been traced in it, and there is never interstitial hemorrhage; the rapidity of its growth is variable, and it is not disposed to form adhesions to the surrounding parts; when it ulcerates its progress is more rapid than before. The only treatment for it is extirpating the eye-ball, and this has been found to save life in four cases out of every five. The following statement is made by Mr. Mackenzie:—"In the early stage, the patient complains of imperfect or destroyed vision, with a sense of fulness and pain in and around the eye, followed by enlargement of the eye-ball, attenuation of the sclerotica, so that a mass of black substance appears shining through it, and a peculiar opaque appearance of the pupil, the cornea or sclerotica gives way, and a black fungus protrudes, which increases slowly and in general does not bleed much. If the tumour which protrudes from the eye be cut off, the part heals, and by and by the melanosis protrudes afresh. This I have witnessed in two cases. In one case in which Dr. Rainy extirpated the eye-ball at the Glasgow Eye Infirmary, the optic nerve was affected with the melanotic degeneration, but not all the way back to the optic foramen."

Extirpation of the Eye-ball.—Much has been said by authors on the nicety, &c., of the operation for removing the eye-ball; their remarks, however, in general, seemed to be based on the supposition that the organ was in a perfectly healthy state, and they appear generally to forget that we are never called upon to perform such an operation except when the eye, generally speaking, is one confused mass of disordered substance. When the eye is to be extirpated,

the position of the patient may be the same as in the operation for cataract or artificial pupil, but generally speaking, the horizontal position is the best. The assistant should support the upper and depress the lower lids; and if, from the size of the tumour, this is difficult to accomplish, the lids may be disunited at their external canthus by means of an incision carried through the fibrous layer of the lids and the conjunctiva. The edges of the wound should be brought together again, and if possible united by the first intention, as soon as the eye-ball has been extirpated. This incision being made, and the assistant having the lids well separated, the operator should, by means of a curved needle, pass a ligature through the eye-ball from side to side, he should then take hold of the ligature in his left hand, and by means of it draw the eye-ball outwards and forwards, then with a bistoury, which he holds in his right hand, separate the conjunctiva from the internal canthus, and push the bistoury directly backwards into the bottom of the orbit, then turning his hand downwards and outwards, he with the edge of the bistoury, which he carries by this movement to the external canthus, separates the eye-ball from the edge of the lower lid, and cuts across the fibres of the inferior oblique muscle. Then in a similar manner he carries the bistoury round the upper part of the orbit, separating the eye-ball from the upper edge of the upper lid, and cutting across the fibres of the levator palpebræ and superior oblique muscles, or perhaps the ligament through which the tendon of the latter runs. The operator must then draw the eye-ball downwards and forwards, and either with the bistoury or a pair of curved scissors, divide the origin of all the muscles, and the optic nerve close to the foramen opticum. The eye is thus removed, after which the surgeon should at once remove the lachrymal gland and all the soft parts within the orbit. If the eye-lids are diseased, they should be first removed from their

attachment to the orbit, when the globe can be removed with the lids adhering to it. If the lids are not diseased the operator should preserve as much of the palpebral conjunctiva as is possible, to hold in an artificial eye.

The bleeding that takes place during and after the operation is, generally speaking, very little, and will stop by exposing the parts to the air, or syringing out the orbit with a little cold water; it may, however, be necessary to use some pressure, which is done by filling up the orbit with lint, then closing the lids, and covering them with a compress and bandage. The lint should be removed on the second or third day. If there is no bleeding, lint should not be put at all into the orbit after the operation, but the lids should be closed and covered with a compress and bandage. The patient should be kept in bed for ten days afterwards, on low diet, and the state of the bowels should be particularly attended to.

Adaptation of an Artificial Eye.—That an artificial eye may be the more like the natural eye, there must be a part of the eye-ball and all the palpebral conjunctiva preserved. If the eye-ball is too large to admit of an artificial eye, part of it must be removed, and the wound allowed to heal perfectly before the artificial eye is adapted; and if there are any adhesions of the eye-lids they also must be removed. If all the soft parts are removed from the orbit, it is very difficult to adapt an artificial eye. That an artificial eye may have a natural appearance, it should resemble as much as possible the natural eye, in the color of the iris, the size of the pupil, the color of the sclerotic conjunctiva, &c.,—the greatest portion of the sclerotica being superior and external.

It is important that the artificial eye should be a perfect fit, neither pressing upon the stump of the eye-ball, nor so convex as to prevent the lids from closing over it; it should not press upon any part, but should fit exactly; its edge

should be round and smooth, the upper edge of it reaching to the upper fold of the conjunctiva, and the lower edge in like manner to the lower fold. If possible it would be well that the person should begin by wearing a small artificial eye, and increase the size by degrees, until one of a proper size produces no irritation. The manner in which an artificial eye is to be inserted is thus :—The surgeon must take hold of the lower edge between the finger and thumb of the right hand, then, having the upper lid raised by the thumb of the left hand, he is to pass the upper edge of the artificial eye under the lid until it reaches the upper fold of the conjunctiva, in which position he is to hold it and let the lid fall over it ; he must then depress the lower lid until the lower edge of the artificial eye passes over it.

The patient soon learns to do this himself quite readily, and to remove it also, which is done by depressing the lower lid and slipping a small probe or hook under the lower edge of the artificial eye : in doing this the patient must be cautious not to let it fall upon the floor or it will be broken : he should remove this artificial eye every night and re-place it in the morning, having first well washed both the artificial eye and the orbit in cold water. The principal use of an artificial eye is to improve the patient's appearance, but there is another important use, which is to convey the tears and mucus to the internal canthus, so that they may pass down into the nose, instead of passing over the cheek, as they usually do in such cases.

CHAPTER XXII.

VARIOUS STATES OF THE EYE INDEPENDENT OF INFLAMMATION.

Arcus Scutlis.—This term is given to an opaque ring of a dark white color which forms a little within the circumference of the cornea; it sometimes, however, surrounds only half of the cornea, presenting a semi-lunar shape. It is in old persons that it appears, and its appearance is ascribed to a diminished nutrition, or marasmus, of the part; it is no impediment to sight, and of very little practical importance; some have considered that when it was very broad, it was an objection to extraction of cataract: as it would be difficult to get the wound in the cornea to unite. Dr. Ammon stated that he found on dissection a similar and corresponding opacity round the margin of the lens, some of the pathologists of the present day consider it a fatty degeneration of the cornea.

Myosis.—This is a preternatural contracted state of the pupil, completely independent of inflammation. The aperture is perfectly regular, but is entirely incapable of dilatation, so that if myosis is complete the patient is almost perfectly blind, but such a state of the iris is generally accompanied with amaurosis. This state of the pupil differs from that habitually contracted state, which is found in persons who are constantly employed examining minute and shining objects which cause the pupil to contract, and are consequently short-sighted, but in such cases the pupil will dilate more or less by the use of belladonna, or by shading the light from the eyes, while in myosis nothing will dilate the pupil. Myosis is either a spasmodic contraction of the circular fibres of the iris, or a paralysed state of the straight fibres, produced in my opinion by some disor-

dered state of the brain or of the nerves that supply the iris ; the proximate cause, however, is very obscure. Long continued use of the eyes in examining minute and shining objects is considered as an exciting cause.

Treatment.—Rest of the eyes and the avoidance of artificial light, with change of air, and taking exercise, is an important part of the treatment. The patient should partake of light wholesome food, and attend regularly to the state of his bowels. If there are no head symptoms, tonics, such as quinine, may be given. If the brain is the cause, of course that is the part to be attended to.

Mydriasis.—This is a preternatural *dilated* state of the pupil that will not contract even when exposed to the strongest light. It may be caused by a spasmodic contraction of the straight fibres of the iris, or a paralysed state of the circular. It is generally a symptom of some diseased state of the brain, or of the third nerve, or ophthalmic branch of the fifth pair. It is always accompanied by some degree of amaurosis. It has been fully treated of under the head of "Amaurosis from any disordered state of the fifth pair of nerves," Chapter XIX. Some of the French authors have recommended the ergot of rye in this disease, as a medicine having the power of making the pupil contract; I have tried it but could produce no such effect; I have found good effects from the use of veratria and electricity.

Tremulous Iris.—We sometimes observe, that on the slightest motion of the eye the iris trembles; in such a case the undulation of the humours of the eye is sometimes quite perceptible, but even though this latter should not be the case, it is quite evident that the tremulous state of the iris is dependent upon some disorganized state of the humours; indeed it is frequently found accompanied with a broken up vitreous humour, and absorption of the lens. It sometimes follows an operation for cataract, particularly

that by division; it is generally, however, the result of some injury of the eye. Very little benefit has been derived from any treatment either local or general, I met with one gentleman, however, who had received a blow on the eye which produced tremulous iris and mydriasis, and also rendered him quite blind; under the treatment I adopted the pupil contracted and the motion of the iris ceased; this treatment consisted in giving calomel and quinine until the system was affected by the former: at the same time applying electricity to the eye-lids, and brushing round the orbit every day with the eight grain solution of veratria.

Malformations of the Iris.—There are certain defects sometimes observed in the formation of the iris, such as an actual deficiency of a part of its texture causing a slit from the pupil down to the ciliary edge of the iris; this slit is generally of a pyramidal shape, its base the centre of the pupil, and its apex the ciliary edge of the iris. To such a malformation the term *coloboma iridis* is given; it has been found combined with an opacity of the capsule of the lens, with a corresponding fissure in the choroid and retina, and with a similar defect in the upper lip and palate. The same malformation has been found to exist in both eyes, although generally speaking it is only in the one. *Iriderima* or *congenital absence of the iris*, has also been found. In the *Gazette Medicale* for 1st May, 1848, Dr. Texon relates three such cases that came under his observation, all of which were accompanied with partial ptosis. Dr. Stoerber of Strasbourg, has seen this congenital absence of the iris, in both father and son, shewing that the malformation was hereditary. Other malformations have been known, where only a small ring of iris existed round the ciliary margin. I have myself seen a case, (the subject of it a child a year old) where the upper third of the iris was absent and the corresponding portion of the cornea, the pupils contracted and dilated by the stimulus of light. The child's

sight was very bad, but there was no appearance of disease, the mother of the child said she never had sore eyes, and she believed her to have been born with her eyes in this state. The appearance was strange, the child looking as if the upper part of the cornea and iris were cut off. The following account of a malformation of the iris I take from the Dublin Quarterly Review of Medical Science, No. 10, page 472 :—" *Korestenoma*. Von Ammon has applied this term to that peculiar vice of conformation in which there is a preternatural projection of the iris within the circle of the pupil at any one part. It is one of the rarest forms of congenital malformation of the eye." Here follows a wood cut illustrating a case seen in a girl of a scrofulous constitution, who had been born with a hare-lip, and said to be affected with syphilis. The following statement is also made :—" A case similar to this, is reported to have occurred in the practice of the venerable Walther of Munich. The fact, of the case related by Dr. Szokalski having been mistaken and treated for syphilitic iritis with lymph effused on the surface and border of the iris, is in itself a sufficient proof of the necessity of the profession being made acquainted with all these vices of conformation."

Entozoa in the Organ of Vision.—No case of this kind has ever come under my observation. The following classification is given by Mr. Mackenzie :—" 1st. *Echinoccus hominis*, in the cellular substance of the orbit :—" 2nd, *Cysticercus cellulosus*, in the cellular substance of the eyelids, under the conjunctiva, and in the anterior chamber :—" 3rd, *Filaria medinesis*, under the conjunctiva :—" 4th, *Filaria oculi humani* in the crystalline :—" 5th, *Distoma oculi humani* in the crystalline."

When a hydatid appears in the chambers of the eye, it is recommended to let it remain there so long as it produces no irritation ; but if it should produce irritation it should be removed, by making a section of part of the cornea as if for the purpose of extracting the lens.

CHAPTER XXIII.

VARIOUS STATES OF THE EYE WHICH MAY OR MAY NOT BE THE RESULT OF INFLAMMATION.

Irregular Refraction.—When there is irregular refraction from any cause, objects may appear double, triple, or multiplied to various numbers. It may be caused by an irregularity of either the cornea, crystalline, aqueous, or vitreous humours, and any of these states of the eye may or may not be the result of inflammation. The treatment is to remove the cause if practicable. The subject of refraction is fully explained in Chapter IV.

Insensibility of the Eye to certain colors.—There are many individuals who having perfect sight in every other respect, cannot discover certain colors such as red, green, &c. I am acquainted with one gentleman who cannot discover the difference between red and green, except that he says one is a darker color than the other, indeed he cannot understand what is meant by green.—This state of vision in the healthy eye is always congenital, but in the unhealthy eye is a symptom of amaurosis. There have been many theories propounded, as to the cause of this insensibility to certain colors, but all appear to me to be mere theories.

Crupsia, or colored Vision.—This is a symptom often complained of by persons partly amaurotic. It is seeing luminous appearances of various colors floating before the eyes, or settling upon any object the patient looks at. With such symptoms there is generally some disordered state of the retina. (See Amaurosis).

Photopsia, or Shining Spectra.—When a person complains of flashes of light, luminous circles, balls of fire, or glittering stars, appearing before the eyes whether they

are shut or open, it is called photopsia, and should be considered by the surgeon as a precursor of something much worse ; for although it may be caused by some disordered state of the digestive organs, or by general debility, yet it is more generally a symptom of a disordered state of the brain or retina. (See Amaurosis).

Muscae Volitantes.—By this term is meant black spots floating before the eyes ; it is generally a symptom of amaurosis, but unless it is accompanied with some other amaurotic symptom, the surgeon may feel pretty well satisfied that there is no danger of loss of vision, as muscæ are very often a symptom of some disordered state of the digestive organs. (See Amaurosis).

Nyctalopia, or Night-blindness.—In this disease the sight begins to fail after sunset, and is generally lost altogether as night approaches, but returns again when the sun rises the next morning. Within the last five years I have met with a great many cases of this disease, always amongst the poor, and generally in the winter season. Every case I have yet met with I have cured by the following treatment:—I first give an emetico-cathartic, and then quinine in as large doses as the patient can bear. The only local treatment is brushing the eye-lids and round the orbit, with the eight grain solution of veratria. Generally speaking, the surgeon has to take the patient's own word for his complaint, at least so long as he has only night-blindness, for unless the case is very bad, and of long standing, there is no morbid appearance in the eye. Some say the pupil is contracted, others that it is dilated ; I have found it both ; in one case contracted, in another dilated, and in a third acting as usual. Sometimes the disease comes on quite suddenly, but generally speaking it is gradual in its progress, sight being only slightly impaired in the early stage, but getting worse as the disease advances ; at first objects become indistinct at sunset, and the sight becomes gradu-

ally more impaired as night advances, until at length it is totally gone, but again improves at the approach of daylight and it is perfectly restored when the sun appears above the horizon.

Some persons afflicted with this disease, will observe strong artificial light when it is brought near the eye at night ; in others no light is observable. If the disease is allowed to continue, the sight will in course of time become weak even by daylight, and strong light will produce pain and temporary blindness. This disease must be considered as a periodical amaurosis, although why it should occur at such particular periods I am not prepared to say. It would appear to me, that the proximate cause is a venous congestion of the retina, but in this I may be wrong. Pathological anatomy has thrown no light upon the subject. A disordered state of the alimentary canal, suppressed perspiration, or suppression of any periodical discharge, may act as remote causes. Some have considered scurvy a cause, from finding scorbutic patients affected with it ; from the fact of my having met with a greater number of cases of it during the winter season, I am inclined to attribute the cause to the strong reflected light from the snow.

Hemeralopia, or Day-blindness.—This is the same disease as night-blindness, with this simple difference, that it occurs at a different period of the twenty-four hours. It is by no means so frequently met with as night-blindness ; the treatment is the same. The administration of turpentine is sometimes found useful in both diseases.

Hemiopia.—When a part of the field of vision becomes obscured, without any morbid appearance of the eye, such as opacity of the cornea, so that the person sees only part of an object before him, the disease is termed hemiopia. Both eyes may be affected together, or one eye may be affected at one time and the other eye at another time. It generally comes on and disappears very rapidly, sometimes

not lasting more than half an hour at a time ; its frequent occurrence, however, finally produces amaurosis, in fact it is an amaurotic symptom, whether sympathetic or otherwise. It is recorded that Doctor Wollaston had two attacks of this disordered state of vision, at an interval of twenty years. His head being examined after death, the optic thalamus of the right side of the brain was found to be of an unusually large size, and when a section was made of it, hardly a vestige of its natural substance was perceptible, with the exception of a layer of medullary substance on its upper part. Now this may or may not have been the cause of hemiopia, for in many other cases recorded where there was an examination after death, no morbid change was discovered.

I have known persons to be so afflicted, when very much tired from bodily and mental labour, always curing themselves by taking a glass of good wine.

Amblyopia, or Weakness of Sight.—This is not in itself a disease, but a symptom of some disordered state of the eye, very frequently of amaurosis ; therefore no practitioner should treat such a case merely as a weakness of sight, but should endeavor to trace the symptom to its cause, and to remove that cause. If the patient is a female, it is more than probable it will be found depending upon some uterine irritation ; when it cannot be traced to any particular cause, what I have found to answer best, is giving the oxide of silver, made into pills with the extract of gentian.

Scotoma.—By this term is meant a fixed black or dark spot appearing in the axis of vision, and settling upon every object at which the patient looks ; it is a symptom of amaurosis, and has been fully explained in the chapter upon that subject.

INDEX.

PAGE	PAGE
ABDUCENS, or Sixth Nerve, Ana-	Blepharospasmus, 196
tomy of, 17	CALCULI in Lachrymal passages, 133
Physiology of, 51	Caries of the Orbit, 87
Albugo, 392	Caruncula Lachrymalis, Anato-
Amaurosis, 460	my of, 9
TEMPORARY, PRODUCED	Physiology of, 37—52
BY BELLADONNA, 51	Inflammation of, 234
From injury of the	Cassierian Ganglion, description
edge of orbit, 82	of, 15
Amblyopia, 505	CATARACT, TREATMENT OF WITH-
Amaurotica, 465	OUT OPERATION, 349
Anchyloblepharon, 222	By operation, 414
Aneurism from Aanstomosis; in	Operation for, by ex-
the Orbit, 111	traction, 434
By Anastomosis of Eye-	by displacement, 444
brow and Eye-lids, 188	By division, 447
Antrum Hymorianum, tumours	Catoptrical examination
of, 101	in, 417
Disease of, 102	Cataracta Lymphatica, 335
Dessault's	Catarrhal Ophthalmia, 248
Treatment of, 105	Catoplasty, 210
Liston's	Chambers of the Eye, Description
Treatment of, 105	of, 28
Aqueous Humour, Description of, 27	Choroid coat, Anatomy of, 22
Refracts rays	Physiology of, 74
of light, 65	Wounds of, 243
Foreign Bodies	Inflammation of, 316
in, 239	Choroiditis, 316
And its Tunic,	Chromatics, 63
Physiology of, 76	Ciliæ, Description of, 8
Aquo-Capsulitis, 347	Physiology of, 52
Arcus Senilis, 498	Ciliary Arteries Posterior, Anato-
Arteries of the Orbit, Anatomy	my of, 12
of, 11	Long, 12
Ophthalmic, 11	Ciliary Disk, Anatomy of, 22
Physiology of, 31	Physiology, 74
Artificial Eye, 496	Ciliary Ligament, Anatomy of, 23
Artresia iridis completa, 335	Ciliary Muscle, Anatomy of, 23
incompleta, 335	Physiology of, 71
Atrophy of the Eye, 459	Ciliary Nerves, Anatomy of, 19
BELLADONNA, action of, upon the	Physiology of, 50
pupil, 49—51	(See also <i>Ophthalmic Branch of</i>
Blar eyes, 180	<i>the fifth, p. 45</i>)
Blenorrhœa, 137	Ciliary Processes, Anatomy of, 24
Blepharoplastic operation on	Physiology of, 74
eye-lid, 210	Coloboma Iridis, 500

	PAGE		PAGE
Coloboma of the Palpebræ.....	171	Cornea, Ulcers of.....	385
Colors, Insensibility of the Eye		Opacities of.....	389
to certain.....	502	Acupuncture	
Colored Vision.....	502	for removal of.....	396
Concussion of the Eye-ball.....	245	Treatment of	
Conditions of the Eye.....	31	by Abrasion.....	397
Conical Cornea.....	485	Conical.....	485
CONJUNCTIVA, Anatomy of.....	8	Corneitis.....	309
Physiology of.....	52	Corodialysis.....	412
Injuries of.....	224	Corona Ciliaris, Anatomy of.....	25
Foreign Bodies on.....	224	Corotomia.....	408
Disease of.....	224	Crupisia.....	502
Echymosis of.....	227	Crystalline Humour, Description	
Emplysema of.....	227	of.....	28
Phlegmon of.....	228	Physiology of.....	78
Oedema of.....	228	And its Capsule, In-	
Pterygium of.....	228	flammation of.....	549
Pinguecula of.....	230	Crystalline Lens and Capsule,	
Warts of.....	230	Injuries of.....	241
Polypus of.....	231	Dislocation of.....	242
Tumours of.....	231	Dacryocystitis, Acute.....	135
Moles of.....	231	CHRONIC.....	137
Fungus of.....	231	ACETATE OF LEAD	
Eucanthis of.....	232	RECOMMENDED AS A LOCAL	
Mild Inflammation		APPLICATION FOR THE CURE	
of.....	248	OF.....	139
Severe Inflammation		And's treatment of.....	141
of.....	253	Day-blindness.....	504
Conorbital In-		Dioptries.....	57
flammation of.....	272	Diplopia.....	167
Severe Inflammation		Distichiasis.....	213
in Children of.....	280	Double vision.....	167
GRANULAR.....	378	Dropsy of the Eye.....	482
CURED.....	377	Dryness of the Eye.....	123
BY ACETATE OF LEAD.....	381	Echymosis SUB-CONJUNCTIVAL.....	227
Conjunctival Xeroma.....	381	Emplysema.....	227
Corectomia.....	410	Eucanthis.....	232
Cornea, Anatomy of.....	21	Entozoa in the Organ of Vision.....	501
Physiology of.....	76	Epiphora.....	124
Supplied with Vessels,		Erysipelatous Ophthalmia.....	308
Nerves, and Absorbents,	21	Exostosis of the Orbit.....	95
Cornea, turned up by Inferior		Eye, Composition of.....	19
oblique muscle.....	35	EYE BALL, NOT RETRACTED INTO	
Turned down by Super-		THE ORBIT.....	35
ior Muscle.....	35	NOT PUSHED INTO THE	
Rays of Light transmit-		ORBIT BY THE ORBICU-	
ted by it.....	76	LARIS PALPEBRARUM, AS	
A Transparent Medium.....	76	SUPPOSED.....	41
Injuries of.....	234	Oscillation of.....	166
Penetrating Wounds of.....	236	Injuries of.....	234
Effusion of Blood into its		Non malignant Tumours	
layers.....	245	of.....	487
Inflammation of.....	309	Scirrhous.....	489
Abscess of.....	382	Fungus Hematodes of.....	490

	PAGE		PAGE
Eye-ball, Medullary Sarcoma of,	490	Eye-lids, Trichiasis of,	213
Melanosis of,	494	Entropion, or Inversion	
Extirpation of,	494	of,	216
Eye-ball Muscles, Injuries of,	155	Symblepharon of,	221
Paralysis of,	155	Anchyloblepharon of,	222
Eye-brows, Physiology of,	52	Phthiri, or Crab-lice of,	223
Injuries and Diseases		GRANULATION OF,	377
of,	169	CURED BY ACETATE	
Eye-lashes, Description of,	8	OF LEAD,	378
Physiology of,	52	CLOSED DURING SLEEP,	
EYE-LIDS, Injuries and Diseases		BY RELAXATION OF THE	
of,	169	LEVATOR PALPEBRE, E.,	40-41
Contusions of,	169	LOWER LID DEPRESSED	
Poisoned Wounds of,	170	BY CORNEA THROUGH	
Burns and Scalds of,	170	THE AGENCY OF THE	
Incised and Lacerated		SUPERIOR OBLIQUE MUSCLE,	37
Wounds of,	171	FIFTH NERVE, Anatomy of,	15
Phlegmonous Inflammation of,	173	Physiology of,	45
Erysipelatous Inflammation of,	174	Neuralgia of,	478
Carbuncle, or Anthrax of,	176	Fistula Lachrymalis,	131-147
Syphilitic Ulceration of,	177	Modes of Operating for,	143
Scirrhus and Cancer of,	179	Caries of the	
Inflammation of the Edges of,	180	Bones in,	148
Porrigo Larvalis of,	183	Interesting Case of,	150
Meibomian Glands, Disease of,	184	Foreign Bodies on the Conjunctiva,	224
Hordeolum of,	184	Frontal Sinus, Disease of,	105
Phlyctenula of,	185	Fungus Hæmatodes of the Eye-ball,	490
Millium of,	185	GLANDULE CONGREGATE, Encysted Tumours in,	130
Warts on the Edges of,	185	Glaucoma,	358
Eye-lids, Tumours in,	185	Globe of the Eye, Anatomy of,	20
Callosity of,	187	Gonorrhœal Ophthalmia,	272
Nævus Maternus of,	187	GRANULAR CONJUNCTIVA,	377
Aneurism by Anastomosis of,	187	CURED BY	
Œdema of,	194	ACETATE OF LEAD,	378
Emphysema of,	194	Gutta Serena,	460
Twitching of,	195	HEMARALOPIA,	504
Morbid Nictitation of,	196	Hemiopia,	504
Blepharospasmus of,	196	Hernia Sacci Lachrymalis, of	
Paralysis of,	198	Beer,	151
Ptosis of,	199	Hordeolum,	184
Epicanthus of,	202	Humours of the Eye, Refractory Powers of,	65
Lagophthalmos, or Shortening of,	202	Hyaloid Membrane, Anatomy of,	29
Ectropium, or Eversion of,	204	Physiology of,	78
Operation of Catoplastic in,	210	Inflammation of,	358
		Hydrophthalmia,	482

	PAGE		PAGE
Hydrops Sacci Lachrymalis, of Beer.....	150	Lachrymal Gland, Chronic Enlargement of.....	128
Hyperostosis of the Orbit.....	94	Encysted Tumours in.....	129
Hypopium.....	384	Extirpation of.....	133
Dr. MacDonnell's Theory of.....	316	Lachrymal Organs, Physiology of.....	52
INVERSION of the Eye-lids.....	216	Lachrymal Organs, Excreting, Anatomy of.....	9
Ioduretted Iodide of Potassium Mixture.....	94	Diseases of.....	134
Iriderima.....	500	Injuries of.....	153
IRIS, Anatomy of.....	25	Lachrymal Organs, Secreting, Disease of.....	122
Physiology of.....	77	Lachrymal Passages, Calculi of.....	133
Muscularity of Proved.....	25	Lachrymal Sac, Mucocele of.....	150
Receives Nerves from the Ciliary.....	50	Relaxation of.....	151
SOURCES OF ITS MOTION AND SENSATION DUE TO THE FIFTH AND THIRD NERVES, SENSIBLE TO LIGHT, INDEPENDENT OF THE RETINA, A PROTECTION TO THE RETINA.....	50	Lachrymation Sanguineous.....	132
IRIS RECEIVES ITS COLOR FROM THE NERVE.....	77	Lagophthalmos.....	202
Prolapsus of.....	237	Lapis Divinus of Beer.....	154
Desmarres Method of Reducing.....	240	Lapsus Palpebræ Superioris.....	199
Injuries of.....	241	LENS, Description of.....	28
Tremulous.....	499	Physiology of.....	78
Malformations of.....	500	A Fibrous Structure.....	29
Coloboma of.....	500	SUPPLIED WITH VESSELS AND NERVES FROM THE CILIARY PROCESSES.....	29
Congenital Absence of.....	501	Optical, Description of.....	60
IRITIS.....	329	Crystalline, Light Converging of passing through it.....	65
Acute.....	331	Capsule of, Physiology of.....	78
Chronic.....	338	Capsule of, Injury of.....	241
Syphilitic.....	341	Dislocation of.....	242
KERATITIS.....	309	Lens and Capsule, Inflammation of.....	349
Keratomia.....	501	Lenticular Ganglion, Anatomy of.....	18
LACHRYMAL CALCULUS.....	133	Physiology of, See Physiology of Fifth Nerve page 45.	
Nitric Acid RECOMMENDED IN.....	133	Lenticular Ganglion Receives a Twig from the Nasal Nerve.....	45
Lachrymal Ducts, Encysted Tumours in.....	130	Lenticonia.....	323
Obstruction of.....	152	Levator Palpebræ Muscle, Anatomy of.....	4
Congenital Absence of.....	152	Physiology of.....	40
Lachrymal Fistula, True.....	131	Paralysis of.....	199
False.....	147	Light.....	53
Lachrymal Gland, Anatomy of.....	3	Lappus.....	180
Physiology of.....	52	Long sightedness.....	69
Inflammation of.....	125	Lotion, Soothing of McKenzie.....	252
		Lusitas.....	164
		Case of.....	165

	PAGE		PAGE
MAXILLARY SINUS, Tumours of, . . .	101	Nasal Duct, Obstruction of, . . .	144
Disease of, . . .	102	Nasal Nerve receives a twig	
Medullary Sarcoma of,	490	from the Sympathetic,	46
Megalophthalmos,	483	Nebula,	389
Meibomian Glands, or Follicles,		Nerves of the Eye, and Orbit,	
Anatomy of,	8	Anatomy of,	13
Physiology of,	52	Physiology of,	42
Disease of,	184	Neuralgia of the Fifth Nerve, . . .	478
Melanosis of the Eye-ball,	494	Night-Blindness,	503
Membrana Jacobi,	26	Nose, Tumours of,	101
Membrana Pupillaris, Anatomy		Nyctalopia,	503
of,	26	Nystagmus,	167
Membrana Ruschiana,	23	OBLIQUE MUSCLES, Anatomy of, . .	5
Membrana Conjunctivæ, Anato-		Physiology of,	35
my of,	8	INFERIOR, ACTS	
Physiology of,	52	CONSENTANEOUSLY	
Inflammation		WITH THE ORBICU-	
of,	248	LARIS PALPEBRA-	
Millium of the Eye-lids,	185	RUM,	36
Mistura Ioduretted Iodide of		SUPERIOR, THE	
Potassium,	94	DEPRESSOR	
Mistura Terebinthina,	93	OF THE LOWER LID,	37
Moles of the Conjunctiva,	231	Edema, Sub-conjunctival,	228
Monoblepsis,	168	Of the Eye-lids,	194
Motions of the Eye,	32, 33	OPHTHALMIA,	246
Motores Oculorum, Anatomy of,	14	Tarsi,	180
Physiology		Catarrhal,	248
of,	44	Egyptian, or Puru-	
Gives a twig		lent,	253
to Lenticu-		Mr. Guthrie's Treat-	
lar Ganglion,	45	ment of,	267
Musæ Volitantes,	465, 503	Dr. Jacob's do,	270
Muscles of the Eye, Anatomy of,	4	Mr. Ware's do,	271
Physiology		Gonorrhœal,	272
of,	33	Purulent of Infants,	280
SUPPOSITION THAT DIFFERENT		Dr. Jacob's	
MUSCLES ACT ON THE EYE IN		Treatment of,	289
SENSIBILITY AND INSENSIBILITY,		STRUMOUS,	290
DISPROVED,	32	Mr. Hamil-	
Muscles of the Eye-ball, Injuries		ton's Treatment of,	297
of,	155	VERATRIA	
Paralysis of,	155	As a Local Appli-	
Muscles of the Eye-lid, Anato-		cation in,	298
my of,	6	Creasote	
Physiology of,	40	As a Local Appli-	
Mydriasis,	499	cation in,	300
Myopia,	66	Desmarre's	
Myosis,	498	Treatment of,	301
Myotomy, Operation of,	160	Dr. Hocken's	
NÆVUS MATERNUS of the Eye-		Treatment of,	303
brow and Eye-lids,	187	Iodine as a	
Nasal Canal, Anatomy of,	10	Local Application,	303
Physiology of,	52	Morand's	
Nasal Duct, Anatomy of,	10	Treatment of,	303

	PAGE		PAGE
Ophthalmia Pustular,	304	Orbit, Periostosis of,	92
Variolosa,	306	Turpentine in,	93
Ery-sipelatosa,	308	Hyperostosis of,	94
Compound,	374	Exostosis of,	95
Traumatica,	374	Osteo Sarcoma of,	98
Artificial,	374	Deformity of, from Exter-	
Intermittent,	374	nal Pressure,	100
Sympathetic,	376	Tumours in,	108
Ophthalmic Artery, Anatomy		Orbit, Aneurism from Anastomo-	
of,	11	sis in,	111
OPHTHALMIC BRANCH OF THE		Traver's Treat-	
FIFTH NERVE, PHYSIOLOGY OF	45	ment of,	112
A Nutritive Nerve,	46	Dalrymple's do,	112
Absorbent Nerve of the Eye,	46	Guthrie's do,	112
The Protector Nerve of the		Orbital Cellular Membrane, Dis-	
Eye,	47	ease of,	113
Sensitive to the Stimulus of		Infiltration of,	116
Light,	48	Scurfus of,	117
Ophthalmic Nerve, Anatomy of,	15	Oscillation of the Eye ball,	166
Physiology		Ossific Deposits in different parts	
of,	45	of the Eye,	480
Ophthalmic Ointment of Japan,	139	Osteo-sarcoma,	98
Ophthalmitis,	362	Palpebre, Anatomy of,	6
Optics,	53	Periosteum, Physiology of,	31
Optic Nerve, Anatomy of,	13	Periostitis of the Orbit,	87
Physiology of,	44	Periostosis,	92
ORBITARIUS PALPEBRARUM Mus-		Phlegmon, Sub-conjunctival,	228
cle, Anatomy of,	6	Phlyctenula of the Eye lids,	185
Physiology of,	40	Phlyctenular Ophthalmia,	220
Paralysis of,	198	Mr Hamilton's	
DOES NOT KEEP THE EYE		Treatment of,	297
FROM PROTRUDING, AS SUP-		VERATRIA AS A	
POSEID,	41	Local Application	
ORBIT, Anatomy of,	1	in,	298
Physiology of,	30	Creasote,	300
Bones of,	1	Desmarre's	
Foramina of,	2	Treatment of,	301
Contents of,	3	Dr. Hecken's	
Anatomy of Vessels and		do,	303
Nerves of,	11	Iodine as a	
Injuries of,	79	Local Application,	303
Contusion of its Edges,	79	Morand's Treat-	
Fractures of its Edges,	80	ment of,	303
PUNCTURING INSTRUMENTS		Phetopsia,	502
TO GIVE EXIT TO AIR NOT		Phthiriasis,	223
NECESSARY,	81	Pigmentum Nigrum, Physiology	
Wounds of its Edge,	81	of,	74
Gun-shot do,	82	Pinguecula,	230
General Prognosis of		Polypus of the Nose,	100
Wounds,	82	CURE OF BY PRESSURE	
Fractures and Injuries of		AND ACETAS PLUMBI,	101
its Walls,	85	Of the Maxillary Sinus,	101
Disease of,	86	Of Lachrymal Sac,	152
Secondary Caries of,	88	Of the Conjunctiva,	231

PAGE		PAGE	
183	Porrigo Larvalis of the Eye-lids,	312	Scleratitis,
27	Porus Opticus, Anatomy of,	316	Dr. MacDonnell's Treatment of,
75	Physiology of,	505	Scotoma,
69	Presbyopia (Long-sightedness), ..	290	Scrofulous Ophthalmia,
180	Psorophthalmia,	297	Mr. Hamilton's Treatment of,
228	Pterygium,	298	VERATRIA as a
91, 199	Ptosis,	300	Local Application in,
152	Puncta Lachrymalia, Obstruction of,	300	Creasote as do., do.,
153	Puncta and Canals, Relaxation of,	301	Desmarre's Treatment of,
27, 75	Punctum Aureum,	303	Dr. Hocken's do., ..
25	Pupil, Anatomy of,	303	Morand's do.,
49	CONTRACTS FROM PAEN, ..	303	Iodine as a Local Application,
50	ACTION OF BELLADONNA ON,	9	Semi-lunar fold, Anatomy of, ..
49	ACTION OF NITRATE OF SILVER ON,	52	Semi-lunar Membrane,
71	CHANGES WHICH IT UNDERGOES TO ADAPT THE EYE TO NEAR AND REMOTE OBJECTS, ..	234	Inflammation of, ..
401	Obliteration of,	502	Shining Spectra,
402	Artificial,	66	Short-sightedness,
405	Operation not always Advisable, when there is one Sound Eye,	73	Sight, CHANGES WHICH THE EYE UNDERGOES TO ADAPT ITSELF TO REMOTE AND NEAR OBJECTS, ..
304	Pustular Ophthalmia,	71	Todd's Theory of do., ..
4	RECTI MUSCLES, Anatomy of, ..	32	Sleep, Position of the Eye during,
33	Physiology of, ..	41	EYE-LIDS CLOSED DURING SLEEP BY RELAXATION OF THE LEVATOR PALPEBRÆ,
34	NEW VIEWS CONCERNING THEIR USE, ..	27, 75	Soemmering's Spot,
502	Refraction, Irregular,	252	Soothing Lotion,
65	Refraction of Rays of Light, ..	107	Sphenoidal Sinus, Diseases of, ..
26	Retina, Anatomy of,	452	Staphyloma,
75	Physiology of,	456	Conical,
11	Central Artery of,	457	Racemosum,
75	Organ of Sense,	457	Sclerotica,
70	How Objects are Pictured on,	453	Spherical,
321	Inflammation of,	31	States of the Eye,
321	Retinitis, Acute,	5, 156	Strabismus (or Squint),
327	Chronic,	158	DIAGNOSIS BETWEEN IT AND LUSCITAS,
35	ROLLING OF THE EYE, DISPUTED, ..	160	Bonnet's Theory of the Cause of failure in Operation for,
150	SAC LACHRYMAL, Mucocoele of, ..	160	Mode of Operation for,
151	Relaxation of,	184	Stye,
152	Polypus of,	143	Styles, Description of,
132	Sanguineous Lachrymation,	62	Sun-light,
180	Scabies Palpebrarum,	221	Symblepharon,
489	Scirrhus of the Eye-ball,	44	Sympathetic Nerve, Description of,
20	Sclerotic Coat, Anatomy of,		
74	Physiology of,		
243	Wounds of,		
312	Inflammation of,		

PAGE		PAGE
459	Synochia,	Tunica Vaginalis Oculi, Anatomy of,
401	Synechia, Anterior,	4
401	Posterior,	Physiology of,
341	Syphilitic Iritia,	31
8	TARSAL CARTILAGES, Anatomy of,	Inflammation of,
131	TEARS, MORBID, THEORY OF DISRUPTED,	Mr. Ferrall on,
132	Tears of Blood,	171
7	Tendo Oculi Muscle, Anatomy of,	Turpentine Mixture of Carmichael,
7	Tensor Tarsi Muscle, Anatomy of,	187
41	Physiology of,	26
168	Tetanus Oculi,	77
478	Tic Douloureux,	306
180	Tinea Palpebrarum,	460
213	Trichiasis,	23
15	Trigemini or Fifth Nerve, Anatomy of,	124
45	Physiology of,	73
15	Trochleator, or Fourth Nerve, Anatomy of,	Todd's Theory on,
45	Physiology of,	71
487	Tumours, Non-malignant, of the Eye-ball,	465
489	Malignant of,	465
22	Tunica Choroidæa, Anatomy of, Physiology of,	465
74	Injuries of,	167, 465
243	Inflammation of,	Description of,
316	Inflammation of,	29
20	Tunica Sclerotica, Anatomy of, Physiology of,	78
74	Injuries of,	Dissolution of,
243	Inflammation of,	459
312	Inflammation of,	Inflammation of,
		358
		WARTS of the Conjunctiva,
		230
		WATERY EYE,
		124
		Weakness of Sight,
		505
		XEROMA, Conjunctival,
		381
		Xerophthalmia, or Dryness of the Eye,
		123

LIST OF SUBSCRIBERS.

NAME.	RESIDENCE.	No. of COPIES
Abbott, Dr.,	Granby,	1
Adamson, Rev. W. A., D. C. L.,	Montreal,	1
Allard, J. R.,	Belœil,	1
Anderson, John, M. R. C. S. L.,	Lachine,	1
Archambault, Dr.,	St. Hyacinthe,	1
Arnoldi, F. C. T., M. D.,	Montreal,	1
Badgley, Francis, M. D.,	Montreal,	1
Barber, Dr. J. P.,	Clarenceville,	1
Bardy, Dr. Louis G.,	St. Pie,	1
Bethune, Rev. John, D. D.,	Montreal,	1
Bethune, John G., M. D.,	Berthier,	1
Blanchet, Jean, M. R. C. S. L.,	Quebec,	1
Boucher, G. De la Bruere,	St. Hyacinthe,	1
Bosselle, John,	St. Rosalie,	1
Bouthillier and Turcot,	St. Hyacinthe,	1
Brookes, Samuel S.,	Sherbrooke,	1
Brousseau, J. B.,	Belœil,	1
Brown, Charles, M. D.,	Dunham,	1
Brown, L., M. D.,	Cowansville,	1
Brouse, A. M., M. D.,	Prescott,	1
Brigham, J. S., M. D.,	Philipsburg,	1
Butler, J. C., M. D.,	Dunham,	1
Calder, B. E., M. D.,	Lachine,	1
Cameron, Hon. M.,	Toronto,	1
Carr, Dr.,	71st Regiment,	1
Carrier, Joseph, M. D.,	Quebec,	1
Carson, A., M. D.,	St. Catherines, C. W.,	1
Challinor, Fras., M. D.,	Kingsey,	1
Chamberlain, Dr.,	Frelighsburg,	1
Consigny, A. P. L.,	St. Cesaire,	1
Cotton, C. E., M. D.,	Brome,	1
Crevier, Dr. J. A.,	St. Hyacinthe,	1
Cummins, John S.,	Sherbrooke,	1
David, A. H., M. D.,	Montreal,	1
Davignon, Dr., M. P. P.,	Longueuil,	1
D'Amour, Dr. R. H.,	St. Pie,	1
Dease, P. W., M. D.,	Philipsburg,	1
De Lisle, B. D., M. D.,	Henryville,	1
Derbshire, S.,	Toronto,	1
Dessaules, L. A.,	St. Hyacinthe,	1
Dickinson, E. M., Dentist,	Montreal,	1
Eamondson, R., M. D.,	Brockville,	1
Fenwick, George E., M. D.,	Montreal,	1

NAME.	RESIDENCE.	No. of Copies.
Forbes, William, M. D.,.....	St. Bridget.....	1
Ford, Henry, Surgeon, Provl. Cavalry....	Lacole.....	1
Foster, H. M., M. D.,.....	Frost Village.....	1
Foster, S., M. D.,.....	Do.....	1
Fraser, Wm., M. D.,.....	Montreal.....	1
French, J., M. D., I. G. of Hospital.....	Do.....	1
Governor General, His Excellency The...	Toronto.....	1
Gariopy, Dr. J.,.....	Laprairie.....	1
Gibb, George D., M. D.,.....	Montreal.....	1
Gilmer, W. A. R., M. D.,.....	Three Rivers.....	1
Godfrey, Robert, M. D.,.....	Montreal.....	1
Göing, Frederick, M. D.,.....	St. Thomas, C. W.,.....	2
Griffin, F.,.....	Montreal.....	1
Guerrin, Dr. Thomas.....	St. Laurent.....	1
Hall, Archibald, M. D.,.....	Montreal.....	1
Hall, Dr.,.....	St. Thomas, C. W.,.....	1
Hebert, L. G.,.....	Henryville.....	1
Hensly, Joseph.....	St. Athanase.....	1
Hingston, Wm. H.,.....	Montreal.....	1
Howard, R. P., M. D.,.....	Montreal.....	1
Jamieson, B. R.,.....	St. Césaire.....	1
Janson, J. M. D.,.....	Farnham.....	1
Johnson, Dr. Thomas.....	River St. Claire.....	1
Jones, Thomas Walter, M. D.,.....	Montreal.....	1
Kimber, Dr. T.,.....	Chambly.....	1
Lafin, Dr. U.,.....	Charonville.....	1
LaFontaine, Dr. J. D.,.....	St. Edward.....	1
LaFontaine, C.,.....	Chambly.....	1
Laframboise, M.,.....	St. Hyacinthe.....	1
LaRoque, Dr. B.,.....	L'Acadie.....	1
Low, G. W., M. D.,.....	Darlington, C. W.,.....	1
Macdonnell, R. L., M. D.,.....	Montreal.....	1
Macdonell, A. C.,.....	Do.....	1
Mair, David.....	Brockville.....	1
Marsden, William, M. D.,.....	Quebec.....	1
MaeCallum, D., M. D.,.....	Montreal.....	1
McDuff, Timothy, M. D.,.....	Village des Pies.....	1
McQueen, Dr.,.....	Brockville.....	1
Minkler, E., M. D.,.....	Grandy.....	1
Montagu, John P., M.,.....	London.....	1
Morau, Dr. P. M.,.....	St. Johns, C. E.,.....	1
Morru, Joseph, M. D.,.....	Quebec.....	1
Moorhead, R. S. T.,.....	St. Gregoire de Montauban.....	1
Mount, Henry, M. R. C. S. L.,.....	Montreal.....	1
Nelson, Walfred, M. D.,.....	Montreal.....	1
Newell, O. M. D.,.....	Dunham.....	1

LIST OF SUBSCRIBERS.

517

NAME.	RESIDENCE.	No. OF COPIES.
O'Leary, Dr. J., Surgeon,.....	St. Hyacinthe,.....	1
Poulin, Joseph W., M. D.,.....	St. Marie de Monnoir,..	1
Patrick, William,.....	Montreal,.....	1
Peltier, Rev. Mr.	St. Bridget,.....	1
Peltier, Hector, M. D.,.....	Montreal,.....	1
Perrault, T. V.,.....	St. Valentine,.....	1
Regiopolis; His Lordship the Bishop of	Kingston,.....	1
Ridley, Dr.,.....	Belleville,.....	1
Robertson, William, M. D.,.....	St. Andrews,.....	2
Roche, A. R.,.....	Toronto,.....	1
Rollin, A., Dr.,.....	Longueuil,.....	1
Rollet, Dr. J. P.,.....	St. Cesaire,.....	1
Seminary, Superior of the Montreal,....	Montreal,.....	1
Sampson, Dr.,.....	Kingston,.....	1
Scott, W. E., M. D.,.....	Montreal,.....	1
Simard, Dr.,.....	River des Prairies,....	1
Smith, Hermanus, M. D.,.....	Hamilton,.....	1
Smythe, Dr.,.....	Brockville,.....	1
Stuart, Dr. W.,.....	Napierville,.....	1
Sutherland, Wm., M. D.,.....	Montreal,.....	1
Tetreault, Dr. T. A. O.,.....	St. Pie,.....	1
Tierney, George Boston,.....	End of God Speed, Vt.,	1
Thyfault, Jos. W.,.....	Napierville,.....	1
Valois, M. F., M. D.,.....	Pointe Claire,.....	1
Valiquet, Dr.,.....	Farnham,.....	1
Verity, Fred. S.,.....	Hemmingford,.....	1
Whitcomb, J. G., M. D.,.....	Granby,.....	1
Wight, R. H., M. D.,.....	St. Johns, C. E.,.....	1
Wolf, James T.,.....	Quebec,.....	1
Worknan, Benjamin,.....	Montreal,.....	1
Wright, Wm., M. D.,.....	Do.	1
Yates, H., M. D.,.....	Kingston,.....	1

